

Owner's Manual

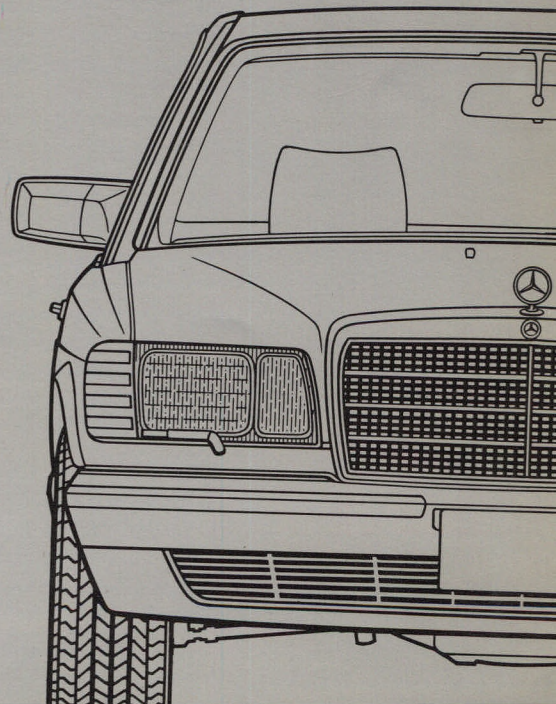

300 SE
300 SEL





16

What You Should Know at the Gas Station

See last page

Drive Sensibly – Save Fuel

Fuel consumption, to a great extent, depends on driving habits and operating conditions.

To save fuel you should:

- keep tires at the recommended inflation pressures
- remove unnecessary loads
- remove ski racks or roof-mounted luggage racks when not in use
- allow engine to warm up under low load use
- avoid frequent acceleration and deceleration
- have all maintenance work performed at regular intervals by an authorized MERCEDES-BENZ dealer.

Fuel consumption is also increased by driving in cold weather, in stop-and-go traffic, on short trips and in hilly country.

Owner's Manual



300 SE **300 SEL**

Model 126

1989

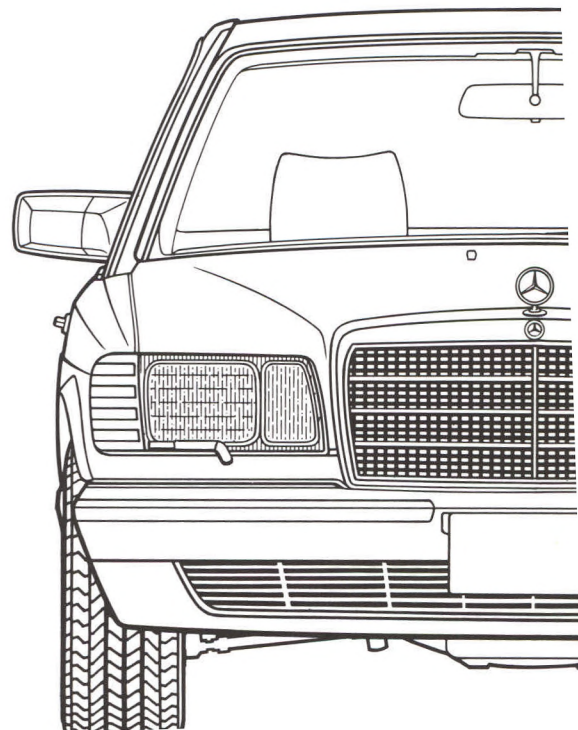

*Kindly observe the following in your own best interests:
We recommend using MERCEDES-BENZ original parts as well as conversion parts and accessories explicitly approved by us for your vehicle model.*

We have subjected these parts to a special test in which their reliability, safety and their special suitability for MERCEDES-BENZ vehicles have been determined.

We are unable to make an assessment for other products and therefore cannot be held responsible for them, even if in individual cases an official approval or authorization should exist.

MERCEDES-BENZ original parts as well as conversion parts and accessories approved by us are available at your MERCEDES-BENZ service station where you will receive comprehensive information, also on permissible technical modifications, and where expert installation will be performed.

Printed in Germany

We reserve the right to modify the technical details of the vehicle as given in the data and illustrations of this Owner's Manual (s.e.e.o.). Reprinting, translation and copying, even of excerpts, is not permitted without our prior authorization in writing.

ZKD/8.88.8/PVL

Our company and staff congratulate you on the purchase of your new MERCEDES-BENZ.

Your selection of our product is a demonstration of your trust in our company name. Further, it exemplifies your desire to own an automobile that will be as easy as possible to operate and provide years of service.

Your MERCEDES-BENZ represents the efforts of many skilled engineers and craftsmen. To ensure your pleasure of ownership, we ask you to make a small investment of your time:

- *Please read this manual carefully before putting it aside.*
- *Please consider the recommendations contained in this manual. They are designed to acquaint you with the operation of your MERCEDES-BENZ.*

We extend our best wishes for many miles of safe, pleasurable driving.

Daimler-Benz Aktiengesellschaft

Introduction

This Owner's Manual contains a great deal of useful information. We urge you to read it carefully and familiarize yourself with the vehicle before driving.

For your own safety and longer service life of the vehicle, we urge you to follow the instructions and warnings. Ignoring them could result in damage to the vehicle or personal injury.

Your vehicle may have some or all of the equipment described. Therefore, you may find explanations of equipment not installed in your vehicle. If you have any questions about the operation of any equipment, your authorized MERCEDES-BENZ dealer will be glad to demonstrate the proper procedures.

Owner's Service and Warranty Policy

The Owner's Service and Warranty Policy Booklet contains detailed information about the warranties covering your MERCEDES-BENZ, including:

- New Car Limited Warranty
- Emission System Warranty
- Emission Performance Warranty
- California Emission Control System Warranty (California Only)

Maintenance

The Maintenance Booklet describes all the necessary maintenance work which should be performed at regular intervals.

Always have the Maintenance Booklet with you when you take the vehicle to your authorized MERCEDES-BENZ dealer for service. The Service Advisor will record each service.

Roadside Assistance

The Mercedes-Benz Roadside Assistance Program provides factory trained technical help in the event of a breakdown. Calls to the toll-free Roadside Assistance number:

1-800-222-0100

will be answered by Mercedes-Benz Customer Assistance Representatives 24 hours a day, 365 days a year.

On-site service calls by a local Mercedes-Benz Roadside Assistance technician are available weekdays from 5:00 PM till midnight, weekends and legal holidays from 8:00 AM till midnight.

For additional information refer to the Mercedes-Benz Roadside Assistance Program brochure in your glove or console storage compartment.

Change of Address or Ownership

If you change your address, be sure to send in the "Change of Address Notice" found in the Owner's Service and Warranty Policy Booklet. It is in your own interest that we can contact you should the need arise.

If you sell your Mercedes, please leave all owner's literature with the vehicle to make it available to the next owner.

If you bought this vehicle used, be sure to send in the "Notice of Purchase of Used Car" found in the Owner's Service and Warranty Policy Booklet.

Operating Your Vehicle Outside the U.S.A. or Canada

If you plan to operate your vehicle in foreign countries, please be aware that:

- unleaded fuels for vehicles with catalytic converters may not be available; the use of leaded fuels will damage the catalyysts,
- fuel may have a considerably lower octane rating, and improper fuel can cause engine damage,
- service facilities or replacement parts may not be readily available.

Certain Mercedes-Benz models are available for delivery in Europe under our European Delivery Program. For details, consult your authorized MERCEDES-BENZ dealer or write to:

Mercedes-Benz of North America, Inc.
European Delivery Department
One Mercedes Drive
Montvale, NJ 07645

In Canada write to:
Mercedes-Benz Canada, Inc.
European Delivery Department
849 Eglinton Avenue East
Toronto, Ontario M4G 2L5

Optional equipment is also described in this manual, including operating instructions wherever necessary. Since they are special-order items, the descriptions and illustrations herein may vary slightly from the actual equipment of your vehicle.

If there are any equipment details that are not shown or described in this Owner's Manual, your authorized MERCEDES-BENZ dealer will be glad to inform you of correct care and operating procedures.

The Owner's Manual and Maintenance Booklet are important documents and should be kept with the vehicle.

**Instruments and Controls, Starting the Engine
Driving Instructions, Service and Maintenance**



Operation



Driving



Practical Hints



**Technical Data
Fuels, Coolants, Lubricants, etc.
Consumer Information**

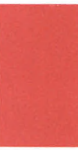

Index

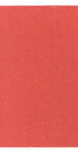

Check Regularly and Before a Long Trip

See page 112

The First 1500 km (1000 Miles)

The more cautiously you treat your vehicle during the break-in period, the more satisfied you will be with its performance later on. Therefore, drive your vehicle during the first 1500 km (1000 miles) at moderate vehicle and engine speeds.

During this period, avoid heavy loads (full throttle driving) and high RPM (no more than $\frac{2}{3}$ of maximum permissible speed in each gear).

Avoid accelerating by kickdown. It is not recommended to brake the vehicle by manually shifting to a lower gear. We recommend to select positions "3" or "2" only at moderate speeds (for hill driving).

After 1500 km (1000 miles) speeds may gradually be increased to the permissible maximum.

Instruments and Controls, Starting the Engine Driving Instructions, Service and Maintenance

Instruments and Controls	10
Instrument Cluster	12
Indicator Lamp Symbols	13
Catalytic Converter	14
Starting and Turning off the Engine	15
Driving Instructions	16
MERCEDES-BENZ Maintenance System	19

Instruments and Controls

For more detailed descriptions see specified pages.

- 1** Volume control for side air outlets (page 22)
- 2** Side air outlets (page 22)
- 3** Adjustable air outlets (page 22)
- 4** Parking brake release (page 60)
- 5** Hood lock release (page 70)
- 6** Parking brake pedal (page 60)
- 7** Combination switch (page 45)
- 8** Exterior lamp switch (page 44)
- 9** Cruise control (page 63)
- 10** Instrument cluster (page 12)
- 11** Horn control, airbag (page 39)
- 12** Steering lock with ignition/starter switch (page 43)
- 13** Air volume control lever for center and side air outlets (page 22)
- 14** Rear window defroster switch (page 49)
- 15** Air recirculation switch (page 22)
- 16** Hazard warning flasher switch
- 17** Automatic antenna switch (page 58)
- 18** Rear passenger compartment lamp switch (page 48)
- 19** Automatic climate control (page 22)
- 20** Radio (page 51)
- 21** Ashtray with lighter (pages 48, 91)
- 22** Left front seat heater switch (page 34)
- 23** Switch for rear window sun shade
- 24** Right front seat heater switch (page 34)
- 25** Left power window switch group (page 50)
- 26** Adjusting switch for exterior mirror on front passenger side (page 46)
- 27** Loudspeaker front to rear fader control
- 28** Right power window switch group (page 50)
- 29** Glove compartment (illuminated in steering lock positions 1 or 2) is not installed in vehicles equipped with a front passenger airbag

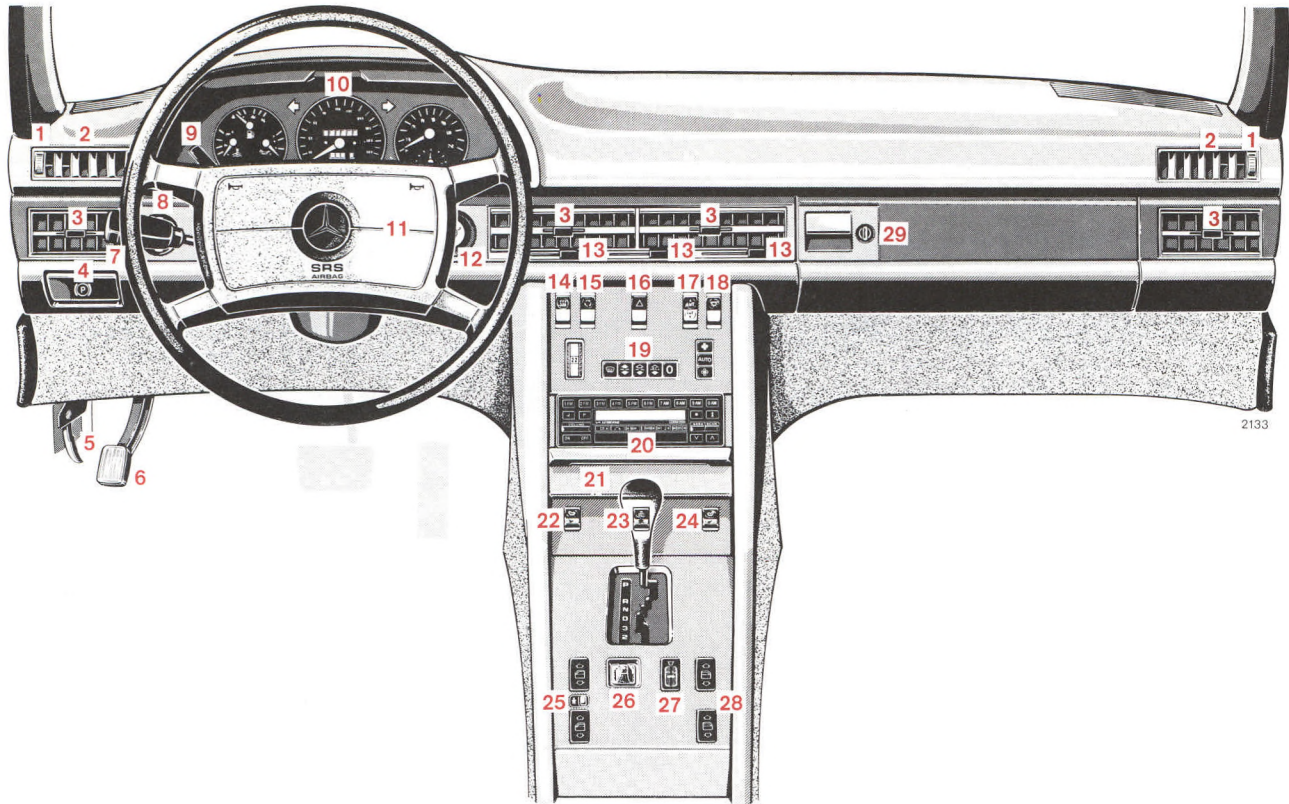

2133



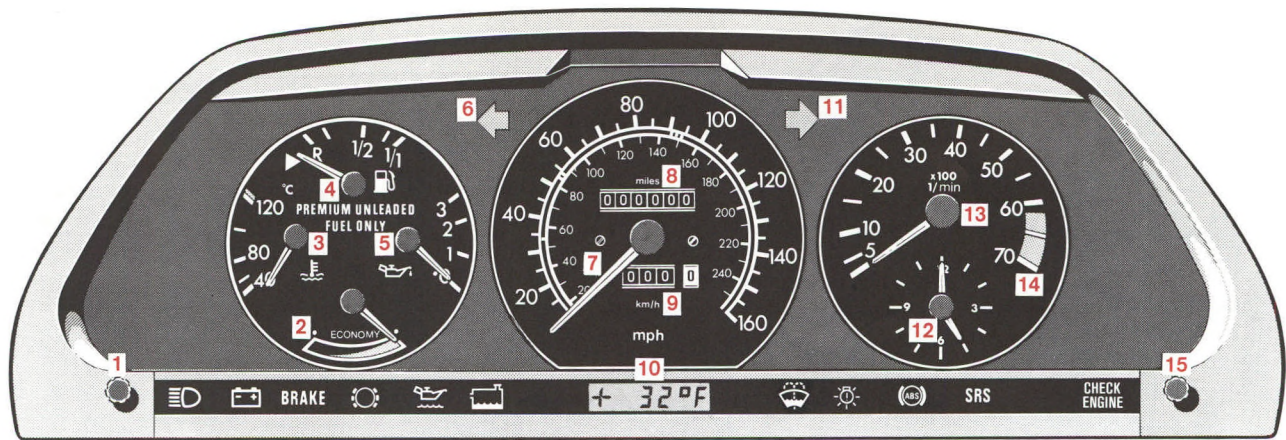

1994

Instrument Cluster

- | | |
|--|--|
| <p>1 Knob for instrument lamps and trip odometer
Rotate knob: To vary intensity of instrument lamps
Depress knob: To reset trip odometer</p> <p>2 Economical driving indicator. See page 68</p> <p>3 Coolant temperature gauge. See page 64</p> <p>4 Fuel gauge with reserve warning lamp (yellow).
See page 65</p> <p>5 Oil pressure gauge (bar). See page 64</p> <p>6 Turn signal indicator lamp, left (green)</p> <p>7 Speedometer</p> | <p>8 Main odometer</p> <p>9 Trip odometer</p> <p>10 Outside temperature indicator. See page 65</p> <p>11 Turn signal indicator lamp, right (green)</p> <p>12 Electric clock</p> <p>13 Tachometer</p> <p>14 Red marking on tachometer:
Excessive engine speed</p> <p>15 Knob for clock adjustment
(press in and rotate for adjustments)</p> |
|--|--|

Indicator Lamp Symbols

Function Indicator Lamp



High beam

Warning Lamps

(should go out with the engine running unless)



Battery not being charged.
See page 64

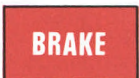

Brake fluid low (except Canada).
Parking brake engaged.
See pages 60, 66



Brake fluid low (Canada only).
Parking brake engaged.
See pages 60, 66



Brake pad wear.
See page 66



Engine oil level low.
See page 64



Coolant level low.
See page 64



Fluid level for windshield and
headlamp washer system low.
See page 65



Exterior light failure.
See page 65



ABS malfunction.
See page 66



SRS malfunction.
See page 39



Engine malfunction.
If the lamp comes on when the engine is
running, it indicates a malfunction of the
O₂-sensor on Federal version vehicles,
and injection system or emission control
system on the California version vehicles.
In either case we recommend that you
have the malfunction checked as soon as
possible.
See page 67

Catalytic Converter

Your MERCEDES-BENZ is equipped with monolithic catalytic converters, an important element in conjunction with the O₂-sensor to achieve substantial control of the pollutants in the exhaust emissions. Keep your vehicle in proper operating condition by following our recommended maintenance instructions as outlined in your maintenance booklet.

Caution!

To prevent damage to the catalytic converters, use only premium unleaded gasoline in this vehicle. Should any noticeable irregularities in the engine operation occur, excessive unburned fuel may reach the converter causing it to overheat.

Warning!

As with any vehicle, do not idle, park or operate this vehicle in areas where combustible materials such as grass, hay or leaves can come into contact with the hot exhaust system, as these materials could be ignited.

Starting and Turning off the Engine

Engage parking brake and move the gear selector lever in either "P" or "N" position before starting the engine.

Turn key to steering lock position 2. The charge indicator lamp should come on.

Cold Engine

Turn key in steering lock clockwise to the stop. Do not depress accelerator. Release key only when the engine is firing regularly.

Hot Engine

Turn key in steering lock clockwise to the stop. Do not depress accelerator. If the engine has not fired after approx. 4 seconds, depress accelerator and continue cranking until the engine is firing regularly. Release key and back off accelerator.

At very high coolant temperatures the engine starting time can be shortened if the accelerator is depressed slowly at the beginning of the starting process.

Turning off

Turn the key to steering lock position 0. Remove the key only when the vehicle has stopped.

If the coolant temperature is very high (e.g. after hard driving on mountain roads), do not shut off the engine immediately, allow it to run for 1–2 minutes at increased idle speed.

Important!

Due to the installed starter non-repeat unit, the key must be returned to steering lock position 0 before a new starting attempt is made.

Observe the oil pressure gauge immediately after starting the engine. In a very cold engine the oil pressure will only rise slowly, some time after the engine has started. Do not speed up the engine before pressure is registered on the pressure gauge.

The charge indicator lamp should go out as soon as the engine has started.

In areas where temperatures frequently drop below -25°C (-13°F), we recommend that a block heater be installed. Your authorized MERCEDES-BENZ dealer will advise you on this subject.

Driving Instructions

Power assistance

When the engine is not running, the brake and steering systems are without power assistance. Under these circumstances, a much greater effort is necessary to stop or steer the vehicle.

Brakes

Caution!

When driving down long and steep grades, relieve the brakes by shifting into “3” or “2”. This helps prevent overheating of the brakes and reduces brake pad wear. Do not exceed engine speed limits (see page 62).

After hard braking it is advisable to drive on for some time so the air stream will cool down the brakes faster.

Warning!

After driving in heavy rain for some time without applying the brakes or through water deep enough to wet brake components, the first braking action may be somewhat reduced and increased pedal pressure may be necessary. Be sure to maintain a safe distance from vehicles in front.

The condition of the parking brake system is checked each time the car is in the shop for maintenance.

Between maintenance checks it is a good practice to apply the parking brake once or twice while driving at approximately 50 km/h (30 mph) on a dry straight road. Apply brake lightly until a slight drag on the wheels is felt. Keep applying brake for about 10 seconds while pulling the release handle out before releasing the parking brake completely. This practice will keep the parking brake at maximum efficiency.

Warning!

The stop lamps will not come on when applying the parking brake only. Perform the procedure in the previous paragraph only when the road is clear of other traffic.

Caution!

Resting your foot on the brake pedal will cause excessive and premature wear of the brake pads.

All checks and maintenance work on the brake system should be carried out by an authorized MERCEDES-BENZ dealer.

If the parking brake is released and the brake warning lamp in the instrument cluster stays on, the brake fluid level in the reservoir is too low.

Brake pad wear or a leak in the system may be the reason for low brake fluid in the reservoir.

Have the brake system inspected at an authorized MERCEDES-BENZ dealer without delay.

Install only brake pads and brake fluid recommended by MERCEDES-BENZ.

If other than recommended brake pads are installed, the braking properties of the vehicle can be affected to an extent that the safety is substantially impaired.

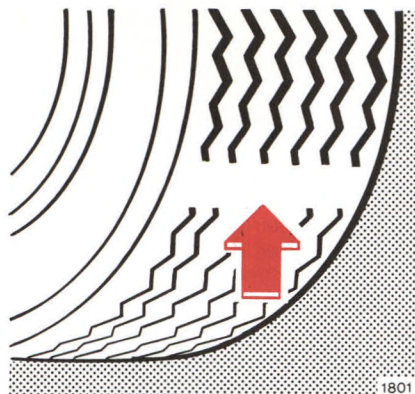

Tires

Tread wear indicators (TWI) are required by law. These indicators are located in six places on the tread circumference and become visible at a depth of approx. 2 mm ($1/16$ in), at which point the tire is considered worn and should be replaced.

The tread wear indicator appears as a solid band across the tread.

Warning!

Do not allow your tires to wear down too far. With less than 3 mm ($1/8$ in) of tread, the adhesion properties on a wet road are sharply reduced.

Depending upon the weather and/or road surface (conditions), the traction varies widely.

Specified tire pressures must be maintained. This applies particularly if the tires are subjected to high loads (e.g. high speeds, heavy loads, high ambient temperatures).

Aquaplaning

Depending on the depth of the water layer on the road, aquaplaning may occur, even at low speeds and with new tires. Avoid track grooves in the road and apply brakes cautiously in the rain.

Tire traction

The safe speed on a wet, snow covered or icy road is always lower than on a dry road.

You should pay particular attention to the condition of the road as soon as the prevailing temperatures fall close to the freezing point.

Warning!

If ice has formed on the road, tire traction will be substantially reduced. Under such weather conditions, drive, steer and brake with extreme caution.

We recommend M + S radial-ply tires for the winter season for all four wheels to insure normal balanced handling characteristics. On packed snow, they can reduce your stopping distance as compared with summer tires. Stopping distance, however, is still considerably greater than when the road is wet or dry.

Parking

Warning!

To reduce the risk of personal injury as a result of vehicle movement, before turning off the engine and leaving the vehicle always:

- 1. Keep foot on brake pedal.**
- 2. Firmly depress parking brake pedal.**
- 3. Move the selector lever to position "P".**
- 4. Slowly release brake pedal.**
- 5. Turn front wheels towards the road curb.**
- 6. Turn the key to steering lock position 0 and remove.**

Note:

It is advisable to set the parking brake whenever leaving the vehicle. In addition, move selector lever to position "P".

Also, when parking on hills, always apply the parking brake.

Winter Driving Instructions

The most important rule for slippery or icy roads is to drive sensibly and to avoid abrupt acceleration, braking and steering action. Do not use the cruise control system under such conditions.

When the vehicle is in danger of skidding, move selector lever to position "N". Try to keep the vehicle under control by corrective steering action.

Road salts and chemicals can adversely affect braking efficiency. Increased pedal force may become necessary to produce the normal brake effect. We therefore recommend depressing the brake pedal repeatedly when traveling on salt-strewn roads at length. This can bring road salt impaired braking efficiency back to normal. A prerequisite is, however, that this is possible without endangering other drivers on the road.

If the vehicle is parked after being driven on salt treated roads, the braking efficiency should be tested as soon as possible after driving is resumed while observing the safety rules in the previous paragraph.

MERCEDES-BENZ Maintenance System

A maintenance booklet is included with your car, listing all the maintenance jobs that must be carried out after the following mileages:

Routine Maintenance

Inspection at
1300 – 1600 km (800 – 1000 miles)

Lubrication Service every
12 000 km (7500 miles)

Maintenance Service every
24 000 km (15 000 miles)

Additional Work every
48 000 km (30 000 miles)

For additional details refer to the
Maintenance Booklet.

In the case of low mileage operation,
the Maintenance Service must be carried
out at least once every 2 years.

Engine Oil and Filter Change

Required every 12 000 km
(7500 miles), or at least once a year
(fall) when using year-round multi-
grade oil; otherwise at least twice a
year (spring and fall).

For engine oil recommendations, see
page 100.

Severe Operating Conditions

Under severe operating conditions or
heavy use, it may be necessary to
carry out prescribed maintenance

jobs at shorter intervals, for example:
Engine: Oil change with filter change
every 6000 km (3750 miles)

Automatic transmission: Fluid change
without filter change every 24 000 km
(15 000 miles)

Tires: Inspect every 12 000 km
(7500 miles)

Air filter: Clean or replace element
every 24 000 km (15 000 miles)

Note:

Severe operating conditions or heavy
use include: predominant city or short
distance driving, frequent mountain
driving, poor roads, dusty or muddy
conditions, etc..

Special Maintenance Measures

Brake fluid should be replaced annu-
ally, preferably in the spring.

It is recommended to use only brake
fluid approved by MERCEDES-BENZ.
Do not mix different types of brake
fluids.

Have the engine coolant (water/anti-
corrosion/antifreeze mixture)
replaced every three years (see
“Fuels, Coolants, Lubricants, etc.”).

Maintenance Vouchers

Your authorized MERCEDES-BENZ
dealer will certify in the maintenance
booklet that all lubrication and
maintenance services have been car-
ried out at the correct intervals.

Operation

Automatic Climate Control	22	Seat Belts and Supplemental	
Car Keys	27	Restraint System (SRS)	36
Opening the Doors	28	Steering Lock	43
Locking and Unlocking of Doors	28	Exterior Lamp Switch	44
Central Locking System	29	Combination Switch	45
Anti-Theft Alarm System	30	Exterior Rear View Mirrors	46
Adjusting Power Seats, Front	30	Inside Rear View Mirror	46
Orthopedic Seat Backrest	32	Sun Visors	47
Adjusting Telescopic		Sliding Roof with	
Steering Column	32	Rear Pop-Up Feature	47
Arm Rest (Front Seats)	33	Interior Lamps	48
Arm Rest (Rear Bench Seat)	33	Lighter	48
Head Restraints, Rear	33	Console Storage Compartment	49
Heated Seats	34	Rear Window Defroster	49
Adjusting Power Seats, Rear	35	Power Windows	50
Adjusting Individual Rear Seats	35	Shelf below Rear Window	50
		Electronic Radio	51



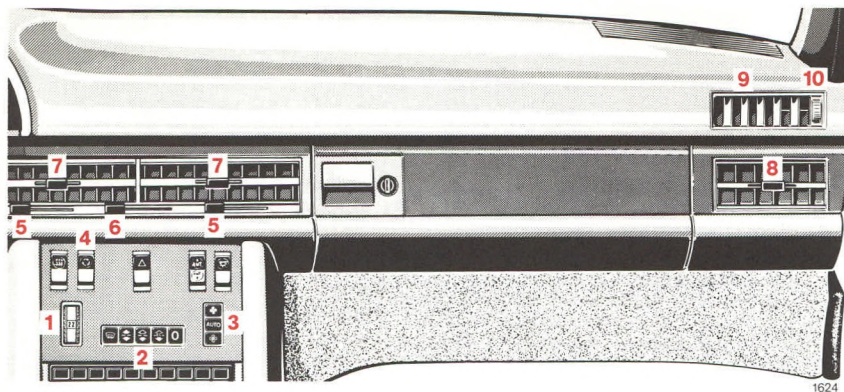









Automatic Climate Control

The engine must be running for the climate control system to operate.

- 1 Temperature selector
- 2 Pushbuttons for function selection

-  Defrost
-  Bi-Level
-  Normal setting
-  EC (Economy)
-  Off (air supply off)

- 3 Fan control buttons
 -  Maximum fan speed
 -  Automatic fan speed control
 -  Minimum fan speed
- 4 Air recirculation switch
- 5 Volume control for adjustable air outlets (8) right and left
- 6 Volume control for adjustable air outlets (7)
- 7, 8 Adjustable air outlets
- 9 Side air outlets
- 10 Volume control for side air outlets (9) right and left

Heating, cooling, and air distribution within the vehicle's interior will be automatically controlled. This is accomplished with the temperature selector (1), the pushbuttons (2) and the fan control buttons (3).

The adjustable air outlets (7) and (8) can be variably opened and closed, or moved to direct the flow of air as desired. The outlets (7) are opened and closed with slide lever (6), and outlets (8) with slide levers (5).

Move slide levers (5) and (6) towards the left to open, towards the right to close.

The air flow from the outlets (9) may be increased by rotating the control (10) up, and reduced by rotating down.

With the exterior lamps turned on (except standing lamps), the symbols on all buttons light up. Each button shines brighter when depressed.

Notes:

The automatic climate control operates properly only if all windows and the sliding roof are kept closed. Air outlets (7), (8) and (9) must not all be closed at the same time.

The air conditioner removes considerable moisture from the air during operation. It is normal, for water to drip on the ground through openings in the underbody.

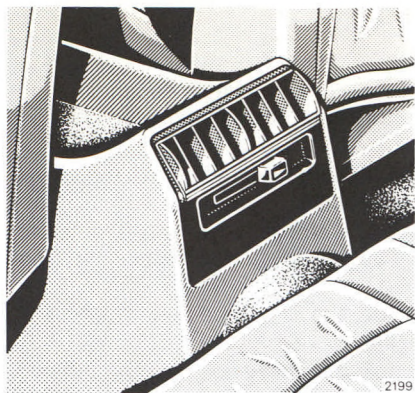

The adjustable air outlet in the rear passenger compartment console provides a variable flow of fresh outside air or cooled air. The air flow is increased by sliding the lever to the left and decreased by sliding the lever to the right.



Temperature Selection (°C)

The desired interior temperature can be selected by rotating the temperature selector. The selected temperature is reached as quickly as possible and maintained. A basic setting of 22 °C (72 °F) is recommended.

If desired, the temperature selector can be rotated to the end positions "MIN" and "MAX". This overrides the automatic mode.

"MIN" (detent) = peak cooling.

"MAX" (detent) = maximum heating.

If button  is depressed with the temperature selector in the "MIN" or "MAX" end positions, the fan will run at near maximum speed.





Air Recirculation

Press symbol side of switch = the air recirculation mode is engaged. The indicator lamp in the switch lights up.

This mode can be selected to prevent annoying odors or dust from entering the car's interior.

At high outside temperatures, the system automatically engages the recirculated air mode and thereby increases the cooling capacity performance.

The recirculated air mode will be automatically switched off after approximately 30 minutes of operation at outside temperatures above approximately 7 °C (45 °F) and after approximately 5 minutes at outside temperatures below approximately 7 °C (45 °F).

At outside temperatures above 20 °C (68 °F), the system can be continuously operated in the recirculated air mode by pressing button  or  and rotating the temperature selector to end position "MIN".

If the windows should fog up from the inside, switch from recirculated air back to fresh air by pressing the lower half of the air recirculation switch (the indicator lamp in the switch goes out).

Note:

It is not possible to switch to recirculated air if button  or  is depressed.

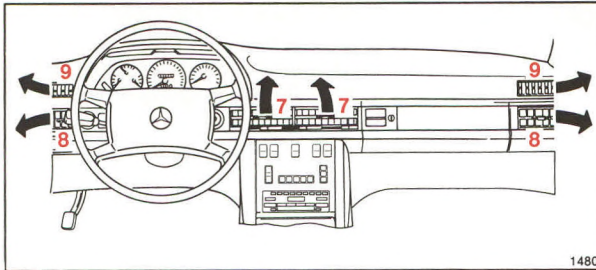

1480



Normal setting – Cooling



Economy setting – Ventilation

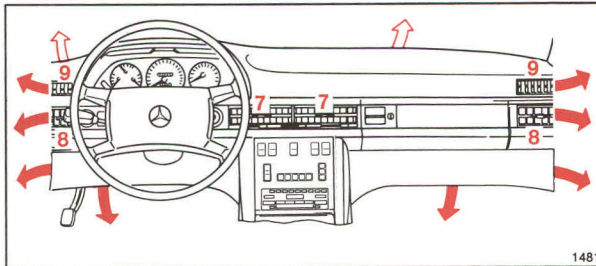

1481



Normal setting – Heating



Economy setting – Heating

Function Setting



Normal setting

The system automatically cools or heats depending on the outside temperature and the selected interior temperature.

- In the cooling mode, air is directed only to the adjustable air outlets (7), (8) and (9).
- In the heating mode, warm air is primarily directed to the foot area and additionally to the ducts in the front doors.

In the heating mode, air will also be periodically emitted from the adjustable air outlets (7).

Enough air is supplied to the windshield and to the side windows to keep the glass free of fog in normal weather conditions.

At low outside temperatures, fan operation does not start until the engine coolant has warmed up.



EC (ECONOMY) = Economical setting

The function of this setting corresponds to the "Normal" setting, however, because the air conditioning compressor will not engage (fuel savings), it is not possible to air condition in this setting.

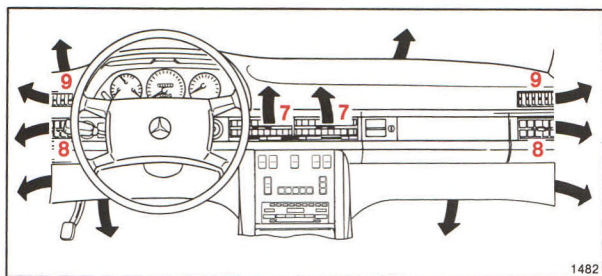

1482

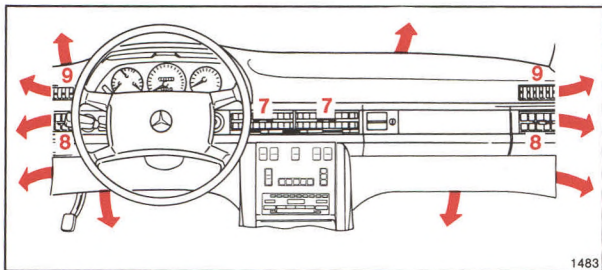

 Bi-Level ventilation – Cooling



1483

 Bi-Level ventilation – Heating

Bi-Level

This setting is used if the inside of the windshield begins to fog up, ice up or when wet snow is falling. As soon as the windshield has cleared, reset to  or .

In the heating mode, warm air is supplied to the windshield, foot area, air outlets (8) and (9), and to the ducts in the front doors. Additionally, air may be emitted periodically from outlets (7), depending on the interior temperature.

In the cooling mode, cool air is supplied to the windshield, foot area, front door ducts, and air outlets (7), (8) and (9).

Note:

In warm, humid climates, prolonged use of this setting may create condensation on the outside of the windshield, directly above the defroster ducts.

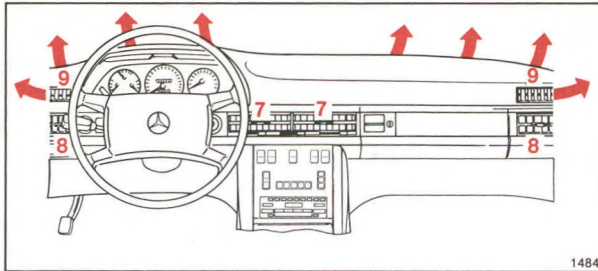

 Defrost

 Defrost

The maximum amount of heated air is directed to the windshield and adjustable air outlets (9) independent of the positions of the temperature selector wheel and fan control buttons.

 Off

The fresh air supply to the car interior is shut off. While driving, use this setting only temporarily.

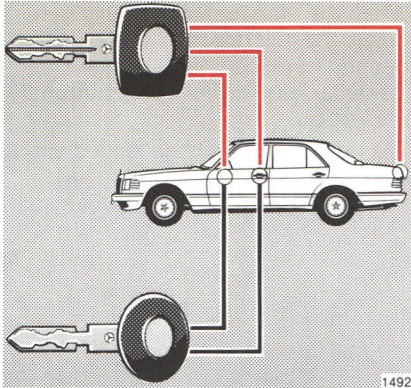

1492

Car Keys

Included with your vehicle are two master keys, one valet key and one flat (master) key.

Master Key – square head with a red dot – fits all locks on the car. Arms/disarms the anti-theft alarm system.

Valet Key – round head with a red dot – fits only the door locks and the steering lock. Arms/disarms the anti-theft alarm system. The valet key will not fit the trunk, glove or console storage compartment locks. This key should be used whenever the car is left with an attendant. Be sure to lock glove or console storage compartment and trunk with the master key.

Flat Key



The flat key with a red dot fits all vehicle locks. Arms/disarms the anti-theft alarm system. We recommend that you carry the flat key with you and keep it in a safe place so that it is always handy. Never leave the flat key in the vehicle.

Obtaining Replacement Keys

Your vehicle is equipped with a theft deterrent locking system requiring a special key manufacturing process. For security reasons, replacement keys can only be obtained via your authorized MERCEDES-BENZ dealer.

Warning!

When leaving the vehicle always remove the key from the steering lock. Do not leave children unattended in the vehicle. Unsupervised use of vehicle equipment may cause serious personal injury.

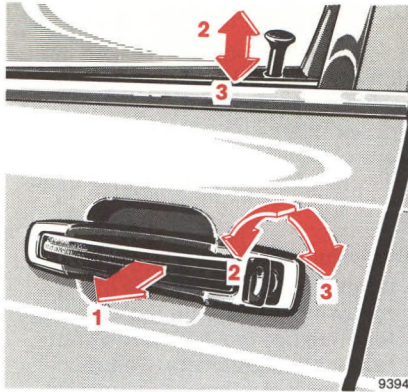

Opening the Doors

From outside: pull handle (1) outwards.

From inside: pull handle (4) in door trim panel.

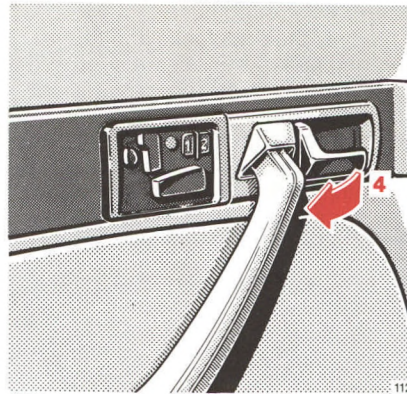

Locking and Unlocking of Doors

From the outside: turn key.

From the inside: actuate door lock button.

- 2 Unlocking
- 3 Locking

When the rear door lock buttons are down, the rear doors cannot be opened from the outside or the inside, unless the door lock buttons are first pulled up.

The driver's door can be locked only if it is closed and the door latch has properly engaged.

Central Locking System

The entire vehicle may be locked or unlocked with the central locking system by:

- Using the master or valet key in either front door.
- Using the master key in the trunk lock.
- By pushing down or pulling up the interior door lock button at either front door.

The central locking system locks or unlocks all doors, trunk lid and fuel filler flap simultaneously.

Doors

When you lock the car, all door lock buttons should move down. If any one stays up, the respective door is not properly closed. You should then unlock the car, open and reclose this door, and lock the car again.

The central locking system can be engaged from the driver-side door lock button, provided the door is completely closed. It can also be engaged from the passenger-side if the ignition key is removed, or the key is inserted in the steering lock without being turned (key in position 0).

If the car has been locked from the outside, the anti-theft alarm will come on if a door is opened from the inside.

Trunk

To unlock the trunk with the central locking system, turn the master key in the trunk lock completely to the left and let it return to the vertical position. Push in trunk lock button and open the trunk. To lock the trunk, turn the master key completely to the right and let it return to the vertical position.

The trunk can remain locked while the central locking system is unlocked (e.g. while driving or when leaving the car in a situation where it must be driven using the valet key, but you wish the trunk to remain locked at parking lots, workshops, etc.). Turn the master key completely to the right and pull it out in the horizontal position. Now the trunk can only be unlocked with the master key by turning it back completely to the left.

Important!

If the trunk is unlocked with the master key, the doors and fuel filler flap will also be unlocked. After closing the trunk, the central locking system must again be engaged using the key to relock the doors and fuel filler flap.

Note:

If the fuel filler flap cannot be opened, refer to "Manual Release of Fuel Filler Flap" (page 84).

Anti-Theft Alarm System

The anti-theft alarm can be armed or disarmed with the master key, valet key or flat key by locking or unlocking either front door or the trunk.

Operation

Once the alarm system has been armed, the exterior vehicle lamps will flash and the horn will sound intermittently when someone:

- opens a door
- opens the trunk
- opens the hood
- removes the radio
- switches on or bridges the ignition circuit
- steps on the brake pedal.

The alarm will last approximately 150 seconds in the form of blinking exterior lamps. At the same time an additional horn will sound intermittently for 60 seconds, pause for 30 seconds, and repeat for another 60 seconds.

The alarm will stay on even if the activating element (a door, for example) is immediately closed.

Note:

If the radio is removed from its mounting when the anti-theft alarm is armed the radio will automatically be rendered inoperative! (This is indicated by a dashed line across the display.)

Do not give the master key to an unauthorized person. We recommend that you carry the flat key safely with you so that it is always handy. This key has the same function as the master key.

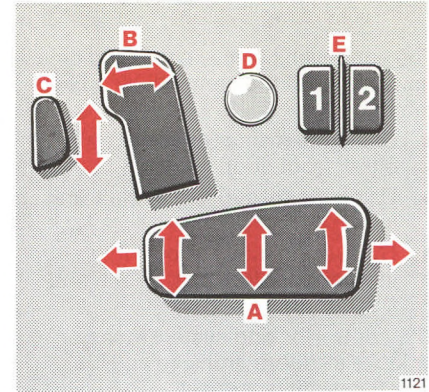

Adjusting Power Seats, Front

The switches are located in each front door.

Turn key to steering lock position 1 or 2 (with the driver's or front passenger's door opened, the power seats can also be operated with the key removed or in steering lock position 0).

Seat and head restraint adjustment:

- A Seat cushion adjustment.
- B Seatback adjustment.
- C Head restraint adjustment.
Adjust head restraint to support the back of the head approximately at ear level. The head restraint can also be tilted forward by hand.

Note:

Your car is equipped with power head restraints, do not try to operate manually.

Warning!

Do not adjust the driver's seat while driving. Adjusting the seat while driving could cause the driver to lose control of the vehicle.

Never ride in a moving vehicle with the seat back reclined. The seat back and seat belts provide the best restraint when the wearer is in an upright position and the belts are properly positioned on the body.

Storing seat/head restraint/steering wheel positions in memory:

- D Memory button.
- E Position buttons "1" and "2".

Two sets of seat/head restraint/steering wheel positions may be programmed into memory. After the seat/head restraint/steering wheel are positioned, push memory button D, release, and within 3 seconds push position button "1". A second set of positions for the same seat/head restraint/steering wheel can be programmed into memory by pushing first button D and then "2".

Recalling seat/head restraint/steering wheel positions stored in memory:

To recall a seat/head restraint/steering wheel position, push position button "1" or "2" until seat/head restraint/steering wheel movement has stopped. For safety reasons, the seat/head restraint/steering wheel movement stops after releasing the position button.

See page 32 for instructions to adjust telescopic steering column.

Caution!

Do not remove head restraints except when mounting seat covers. For removal refer to "Practical Hints", page 92. Whenever restraints have been removed be sure to reinstall them before driving.

Important!

Prior to operating the vehicle, the driver should adjust the seat height for proper vision as well as fore/aft placement and seat back angle to insure adequate control, reach, operation, and comfort. The head restraint should also be adjusted for proper height.

Both the inside and outside rear view mirrors should be adjusted for adequate rearward vision. Fasten seat belts. Infants and small children should be seated in a properly secured restraint system that complies with U.S. Federal Motor Vehicle Safety Standard 213 and Canadian Motor Vehicle Safety Standard 213.1. All seat, head restraint, and rear view mirror adjustments as well as fastening of seat belts should be done before the vehicle is put into motion.

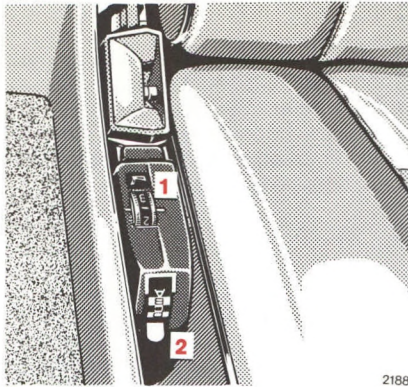

2188

Orthopedic Seat Backrest

Some models may be equipped with orthopedic seats. These seats have an inflatable air cushion built into the backrest to provide additional lumbar support. The amount of cushion height and curvature may be adjusted after turning the key to steering lock position 1 or 2.

The inflation pressure of the air cushion can be varied between position "0" = without pressure, and position "4" = maximum pressure, by changing the pressure regulator (1) setting. In addition, the cushion height may be changed to five different settings between position "A" = lowest setting, and "E" = highest setting, by varying the height regulator (2) adjustment.

If the engine is turned off, the last cushion setting is retained in memory, and automatically adjusts the cushion to this setting when the engine is restarted.

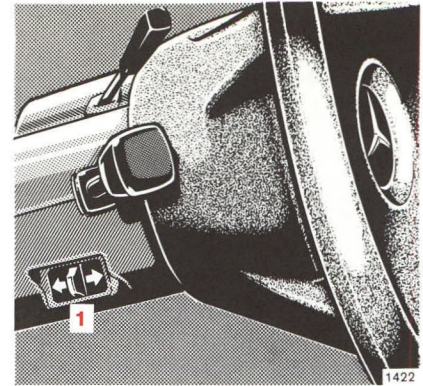

1422

Adjusting Telescopic Steering Column

Turn key to steering lock position 1 or 2 (with the driver's or front passenger's door opened, the telescopic steering column can be operated with the key removed or in steering lock position 0).

To lengthen or shorten the steering column, actuate the switch (1).

Note:

The steering wheel position is stored in memory with the seat and head restraint position.

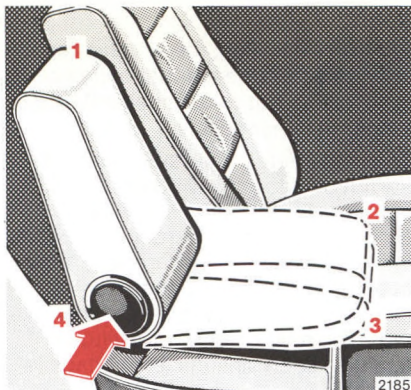

Arm Rest (Front Seats)

Position 1 = arm rest folded up.

Position 2 = for normally inclined seat back.

Position 3 = for extremely inclined seat back.

To adjust arm rest downwards, press release button (4).

Note:

To move the arm rest between positions 1 and 2 it may be necessary to overcome a slight resistance.

Warning!

The arm rest does not suffice as a child restraint system. In case of

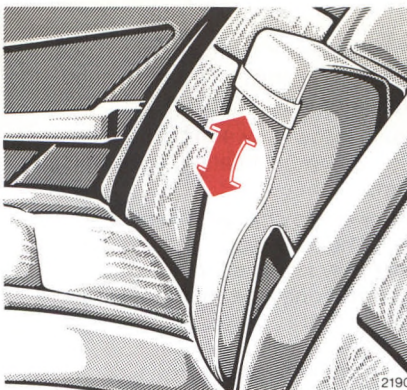

a frontal collision a child can be catapulted forward over the locked arm rest. Infants and small children should be seated in a properly secured restraint system that complies with U.S. Federal Motor Vehicle Safety Standard 213 and Canadian Motor Vehicle Safety Standard 213.1.

Arm Rest (Rear Bench Seat)

When pulling out the arm rest by its strap, the seat belt buckles for the outboard seats swing out automatically.

For the removal of the rear seat cushion see "Practical Hints", page 91.

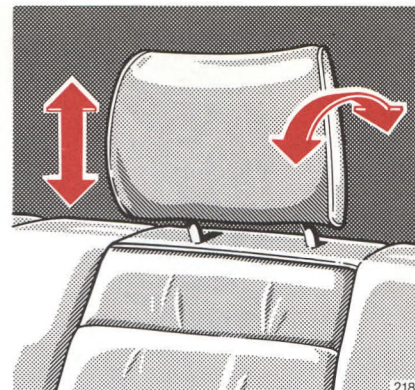

Head Restraints, Rear

Adjust head restraint to support the back of the head approximately at ear level. Do not extend the head restraint past the stop.

For removal of head restraint refer to "Practical Hints", page 92.

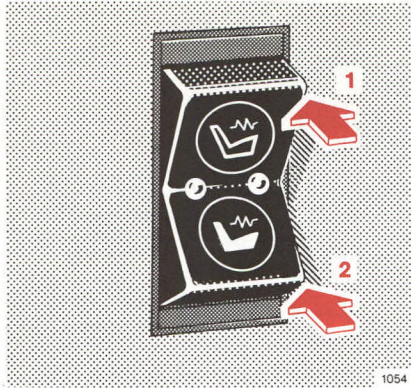

Heated Seats

The front seat heaters can be switched on with the key in steering lock positions 1 or 2, the rear seat heaters only in steering lock position 2.

The switches for the front seats are located at the forward end of the center console, those for the rear seats are located in the rear doors.

Heater operation:

Push in upper switch portion; position 1 = normal heater operation, one indicator lamp lights up.

Push in lower switch portion; position 2 = rapid heating, both indicator lamps light up.

After approximately 5 minutes in the rapid heating mode, the heater automatically switches to normal operation and only one indicator lamp will stay on.

Turning off heater:

If one indicator lamp is on, press in upper part of switch, position 1.

If both indicator lamps are on, press in lower part of switch, position 2.

The heater automatically turns off after approximately 30 minutes of operation.

Notes:

When in operation, the seat heater consumes a large amount of power. It is advisable not to use the seat heater longer than necessary.

The seat heaters may automatically switch off if too many power consumers are switched on at the same time, or if the battery charge is low. When this occurs, the indicator lamp in the switch will blink (both indicator lamps blink during rapid seat heating). The seat heaters will switch on again as soon as sufficient voltage is available.

If the blinking of the indicator lamps is distracting to you, the seat heaters can be switched off.

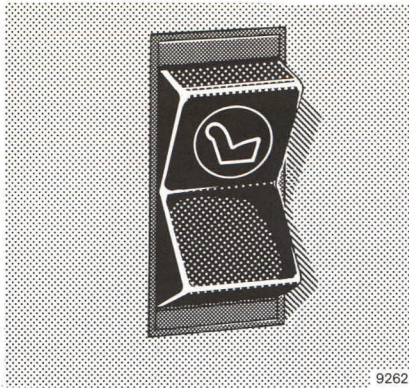

9262

Adjusting Power Seats, Rear

Turn key to steering lock position 1 or 2.

The rear seat can be adjusted using the switch located in either of the rear door. The inclination of the seat back changes with the adjustment of the seat cushion.

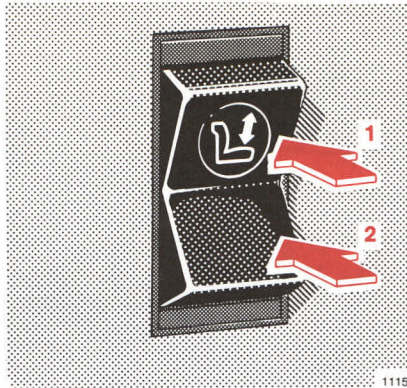

1115

Adjusting Individual Rear Seats

The switches are located on the console between the seats.

Turn key to steering lock position 1 or 2.

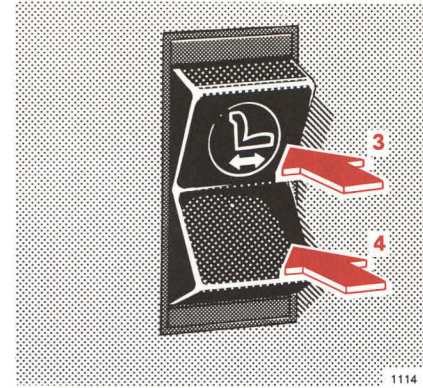

1114

Press switches:

- 1 Upward seat cushion adjustment
- 2 Downward seat cushion adjustment
- 3 Forward seat cushion adjustment
- 4 Rearward seat cushion adjustment

The inclination of the seat back is altered together with the fore/aft adjustment of the seat cushion.



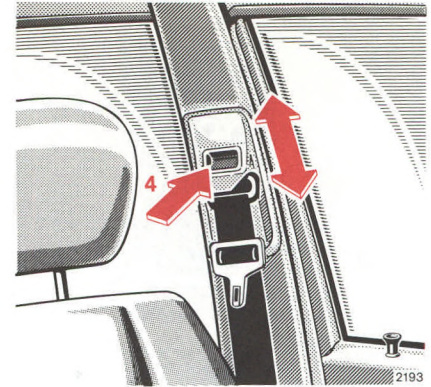
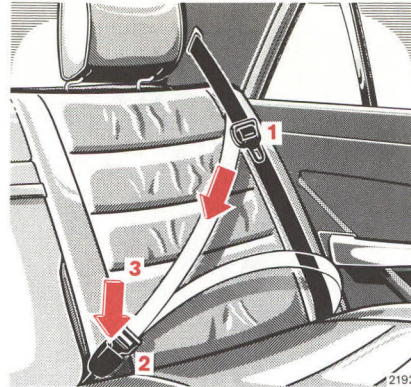
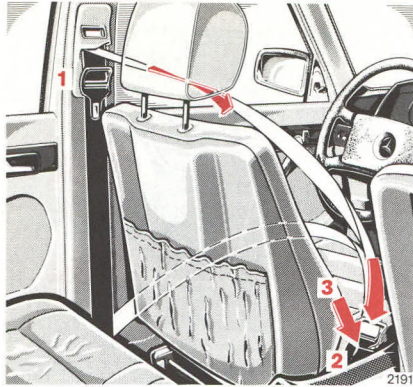

Seat Belts and Supplemental Restraint System (SRS)

Your vehicle is equipped with seat belts for all seats, emergency tensioning retractors for the front seats, driver airbag and knee bolster and optional front passenger airbag and knee bolster.

Seat Belts

Important!

Laws in most states and provinces require seat belt use.

All states and provinces require child restraint use that complies with U.S. Federal Motor Vehicle Safety Standard 213 and Canadian Motor Vehicle Safety Standard 213.1.

Seat Belt Warning System

With the key in steering lock position 2, a warning buzzer sounds for a short time if the driver's seat belt is not fastened.

When someone enters the car the reminder lamp, located below the front interior/reading lamp, flashes for a short time to remind all occupants to fasten seat belts.

Fastening

- Pull belt with latch plate (1) across shoulder and lap so that the lap belt is positioned as low as possible around your hips. Do not twist the belt. For safety reasons,

avoid adjusting the seat into positions which could affect the correct seat belt position.

- Push latch plate (1) into buckle (2) until it clicks.
- Adjust front seat belts so the upper belt is located as close as possible to the middle of the shoulder (it should not touch the neck). For this purpose, push button (4) and raise or lower belt outlet (3 positions).
- The belt must be pulled snug and checked for snugness immediately after engaging it and during driving. If necessary, tighten the lap portion to a snug fit by pulling shoulder portion up.

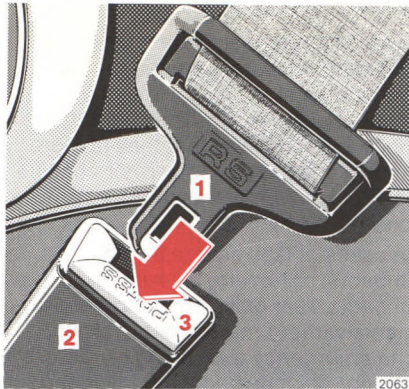

Unfastening

- Push in the red button (3) in the belt buckle (2).
- Allow the retractor to completely rewind the seat belt by guiding the latch plate (1).

Operation:

The inertia reel stops the belt from unwinding during sudden vehicle stops or when quickly pulling on the belt.

The emergency tensioning retractor tightens the seat belt upon major frontal impacts with the shaded area shown on page 38.

The locking function of the reel may be checked by quickly pulling out the belt.

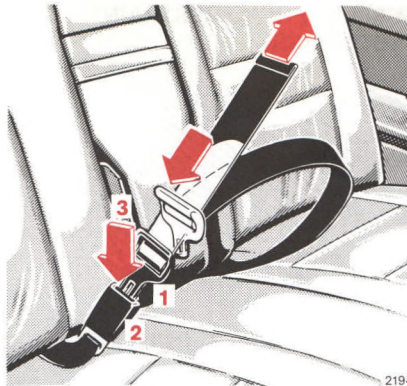

Lap belt for center seating position of the rear seat

Pull belt with latch plate (1) over lap so that the belt is positioned as low on your hips as possible. Push latch plate (1) into buckle (2) until it clicks. Do not twist the belt but keep it tight. For safety reasons, avoid adjusting the seat into positions which could affect the correct seat belt position.

To shorten the belt: With the latch plate engaged, pull the loose end of the belt.

To lengthen the belt: With the belt unfastened, turn the latch plate so that it is a little more than 90 ° perpendicular to the belt, then extend the belt. Fasten the belt and shorten as stated above.

To disengage the belt, push red button (3) in the buckle.

If the center seat is not occupied, the belt buckle and rolled-up seat belt can be stored in the space next to the rear arm rest (to the left or right of arm rest).

Warning!

- **Each occupant should wear their seat belt at all times. Together with the “SRS” (driver airbag, ETR’s, driver-side knee bolster and optional front passenger airbag, front passenger-side knee bolster), the seat belt offers the best conditions for protection of the body in case of major frontal impact. Never wear the shoulder belt under your arm or otherwise out of position. Position the lap belt as low as possible around the hips (not the waist).**
- **According to accident statistics, children are safer when properly restrained in the rear seating positions than in the front seating positions.**

- **Infants and small children must be seated in an infant or child restraint system, which is properly secured by a lap belt or lap belt portion of a lap-shoulder belt. Children could be endangered in an accident if their child restraints are not properly secured in the vehicle.**
- **Children too big for child restraint systems should ride in rear seats using regular seat belts. Position shoulder belt across the chest and shoulder, not the face or neck. A booster seat may be necessary.**
- **Each seat belt should not be used for more than one person at a time.**
- **Belts should not be worn twisted.**
- **Pregnant women should select a seat with a lap-shoulder belt whenever possible. The lap belt should be positioned as low as possible around the hips to avoid any possible pressure on the abdomen.**

For cleaning and care of the seat belts, see page 89.

SUPPLEMENTAL RESTRAINT SYSTEM (SRS)

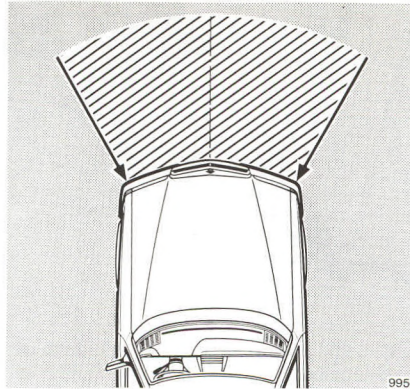

Emergency Tensioning Retractor (ETR)

The seat belts for the front seats are equipped with emergency tensioning retractors. These tensioning retractors are located in each belt's inertia reel and become operationally ready with the key in steering lock position 1 or 2.

The emergency tensioning retractors are designed to activate only when the seat belts are fastened during major frontal impacts within the shaded area shown. They tighten the belts in such a way that they fit more snugly against the body restricting its forward movement as much as possible.

In cases of less severe frontal impacts, roll-overs, certain side impacts, rear collisions, or other accidents without major frontal forces, the emergency tensioning retractors will not be activated. The driver and passengers will then be protected by the fastened seat belts and inertia reel in the usual manner.

For seat belt and emergency tensioning retractor safety guidelines, see page 41.

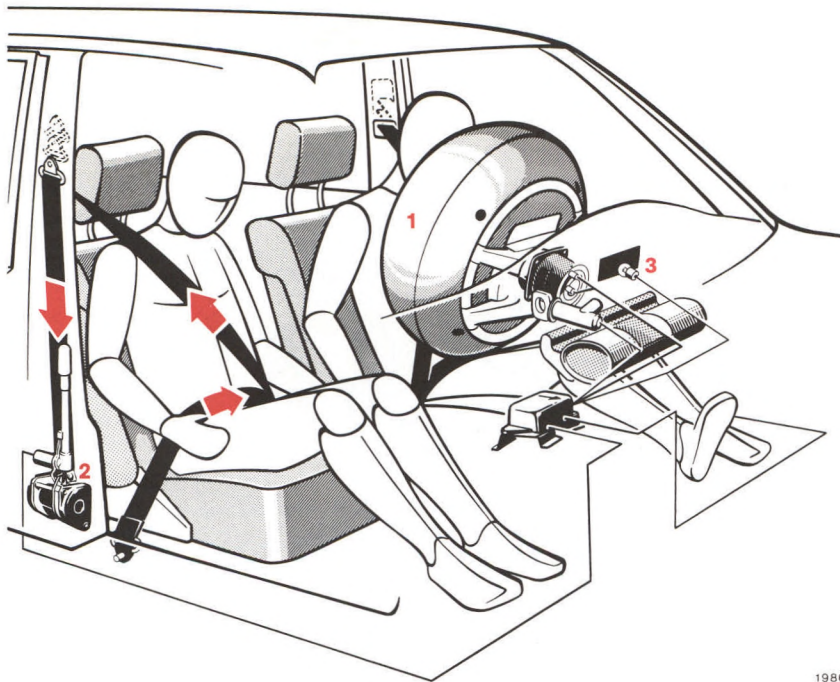

Driver Airbag

The most effective occupant restraint system yet developed for use in production vehicles is the three-point seat belt. In some cases, however, the protective effect of seat belts can be further enhanced by an airbag.

The airbag (1) is located in the steering wheel hub and, in conjunction with wearing the seat belts with emergency tensioning retractors (2), provides increased protection for the driver.

The operational readiness of the airbag system is verified by the indicator lamp "SRS" (3) in the instrument cluster. If no fault is detected, the lamp will go out after approximately 4 seconds; after the lamp goes out, the system continues to monitor the components and circuitry of the airbag system and will indicate a malfunction by coming on again.

The following system components are monitored or undergo a self-check: crash-sensor, airbag ignition circuit, driver and front passenger seat belt buckles. Initially, when the key is turned from steering lock position 0 to positions 1 or 2, malfunctions in the crash-sensor are detected and indicated (the "SRS" indicator lamp stays on longer than 4 seconds).

In the operational mode, after the indicator lamp has gone out after the initial check, interruptions and short circuits in the airbag ignition circuit and in the driver and front passenger seat belt buckle harnesses, and low voltage in the entire system are detected and indicated.

1986

In the event a malfunction of the "SRS" is indicated as outlined above, we strongly recommend that you visit an authorized MERCEDES-BENZ dealer immediately to have the system checked; otherwise the "SRS" may not be activated in a major frontal accident.

Important note:

The airbag is designed to activate only in major frontal impacts within the shaded area shown in the illustration on page 38. Only during these types of impacts will it provide its supplemental protection. The driver should always wear the seat belt, otherwise it is not possible for the airbag to provide its intended protection.

In cases of less severe frontal impacts, roll-overs, certain side impacts, rear collisions, or other accidents without severe frontal forces the airbag will not be activated. The driver and other passengers will then be protected by the fastened seat belts.

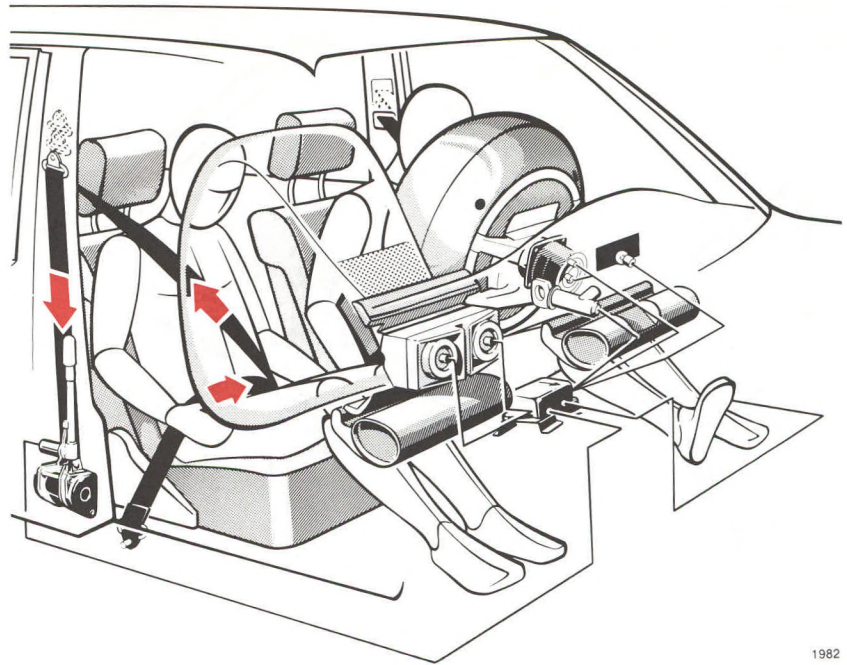

1982

Front Passenger Airbag

If your vehicle is equipped with the optional front passenger airbag, it can be identified by the lettering "SRS-AIRBAG" on the dashboard ahead of the front passenger (cover of airbag unit).

Important note:

The front passenger airbag is designed to activate only in major frontal impacts within the shaded area shown in the illustration on page 38. Only during these types of impacts will it provide its

supplemental protection. The front passenger should always wear the seat belt, otherwise it is not possible for the front passenger airbag to provide its intended protection.

Warning!

Infants and small children must only be seated in a rear seat and be properly secured using a child or infant safety seat/restraint system.

Important note:

The “SRS” is designed to reduce the potential of injury in major frontal impacts, however, no system available today can totally eliminate injuries and fatalities.

The activation of the “SRS” temporarily releases a small amount of dust from the airbag and the seat belt emergency tensioning retractors. This dust, however, is neither injurious to your health, nor does it indicate a fire in the vehicle.

The service life of the airbag extends to the date indicated on the label located on the driver-side door latch post. To provide continued reliability after that date, it should be inspected by an authorized MERCEDES-BENZ dealer at that time and replaced when necessary.

Safety Guidelines for the Seat Belt, Emergency Tensioning Retractor and Airbag

Warning!

- Damaged belts or belts that were highly stressed in an accident must be replaced and their anchoring points must also be checked. Use only belts installed or supplied by an authorized MERCEDES-BENZ dealer.
- Do not pass belts over sharp edges.
- Do not make any modification that could change the effectiveness of the belts.
- An airbag or emergency tensioning retractor (ETR) that was activated must be replaced.
- No modifications of any kind may be made to any components or wiring of the “SRS”. This includes the installation of additional trim material, badges, etc. over the steering wheel hub or front passenger airbag cover and installation of additional electrical/electronic equipment on or near “SRS” components and wiring.

- **Improper work on the system, including incorrect installation and removal, can lead to possible injury through an uncontrolled activation of the “SRS”. In addition, through improper work there is the risk of rendering the “SRS” inoperative. Work on the “SRS” must therefore only be performed by an authorized MERCEDES-BENZ dealer.**
- **When scrapping the airbag unit or emergency tensioning retractor, it is mandatory to follow our safety instructions. These instructions are available at your authorized MERCEDES-BENZ dealer.**

When you sell the vehicle we strongly urge you to give notice to the subsequent owner that it is equipped with a “SRS” by alerting him to the applicable section in the Owner’s Manual.

Infant and Child Restraint Systems

Mercedes-Benz of North America recommends that all infants and children be restrained at all times while the vehicle is in motion.

Important!

The use of infant or child restraints is required by law in all 50 states and all Canadian provinces.

Infants and small children should be seated in an infant or child restraint system, which is properly secured by a lap belt or lap belt portion of a lap-shoulder belt, and that complies with U.S. Federal Motor Vehicle Safety Standard 213 and Canadian Motor Vehicle Safety Standard 213.1. A statement by the child restraint manufacturer of compliance with this standard can be found on the instruction label on the restraint and in the instruction manual provided with the restraint.

When using any infant or child restraint system, be sure to carefully read and follow all manufacturer’s instructions for installation and use.

Warning!

When the child restraint is not in use, remove it from the car or secure it with the seat belt to

prevent the child restraint from becoming a projectile in the event of an accident.

Infants and small children should never be held on the lap, nor should they share a seat belt with another occupant while the vehicle is in motion.

According to accident statistics, children are safer when properly restrained in the rear seating positions than in the front seating positions.

Children too big for child restraint systems should ride in rear seats using regular seat belts. Position shoulder belt across the chest and shoulder, not the face or neck. A booster seat may be necessary.

This vehicle is equipped with tether anchorages for use with child restraints that have a top tether strap. Consult your authorized MERCEDES-BENZ dealer for the exact location of these anchorages.

Note:

Canada Models only

In compliance with Canadian Motor Vehicle Safety Standard 210.1, child restraint tether anchorage hardware is attached to the tool kit located in the trunk.

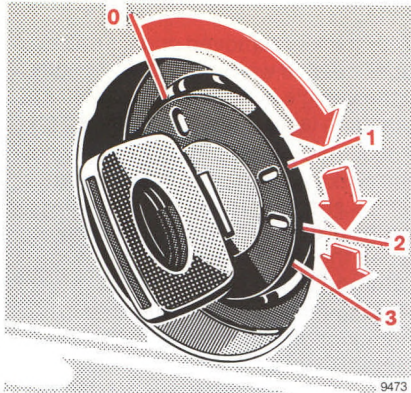

Steering Lock

- 0 Steering is locked when the key is withdrawn and the steering lock is engaged. The key can be withdrawn only in position 0.

Warning!

Do not remove key from the steering lock while the vehicle is in motion as this will cause the engagement of the steering lock thus rendering the vehicle impossible to steer.

- 1 Steering is unlocked.
(If necessary, move steering wheel slightly and turn the key clockwise to position 1.)

- 2 Driving position.
- 3 Starting position.

For starting and turning off the engine, refer to page 15.

Warning!

When leaving the vehicle always remove the key from the steering lock. Do not leave children unattended in the vehicle. Unsupervised use of vehicle equipment may cause serious personal injury.

Notes:

The following items can be operated with the key in steering lock position 1:

Wiper,
windshield washer,
headlamp cleaning system (only in exterior lamp switch positions 1 or 2),
headlamp flasher,
lighter,
glove compartment lamp,
sliding roof,
rear window defroster,
power windows,
power seats, front and rear,
heated seats, front,
orthopedic seat backrest,
telescopic steering column.

A warning buzzer sounds when the driver's door is opened with the key in steering lock position 1 or 0.

With the engine at idle speed, the charging rate of the alternator (output) is limited.

It is therefore recommended to turn off unnecessary electrical consumers while driving in stop and go traffic. This precaution helps to avoid draining the battery.

Unnecessary strain on the battery and charging system may be minimized by turning off the following power consumers, for example: Heated seats, rear window defroster.

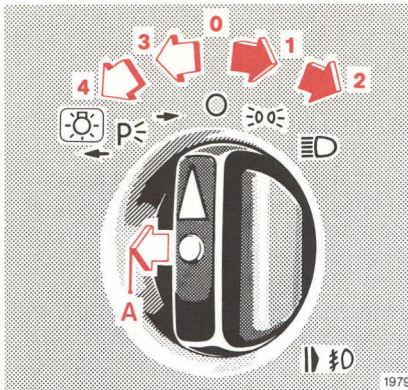

Exterior Lamp Switch

- 0 Off-position
- 1 Parking lamps (includes side marker lamps, taillamps, license plate lamps, instrument panel lamps)
- 2 Same as pos. 1 plus headlamps
- 3 Standing lamps, right
- 4 Standing lamps, left
- A Turn to position 2 and pull out to first stop = same as position 2 plus fog lamps.

Standing lamps

When the vehicle is parked on the street the standing lamps (right or left side parking lamps) can be turned on, making the vehicle more visible to passing vehicles.

The standing lamps can only be operated with steering lock in position 0 or 1.

Notes:

With the key removed and a front door open, a warning buzzer sounds if the vehicle's exterior lamps (except standing lamps) are not switched off. Fog lamps will operate together with the parking lamps, low beam headlamps and high beam headlamps. Fog lamps are turned off automatically when the exterior lamp switch is returned to the off-position. Fog lamps should only be used in conjunction with low beam headlamps. Consult your state Motor Vehicle Regulations regarding fog lamp operation.

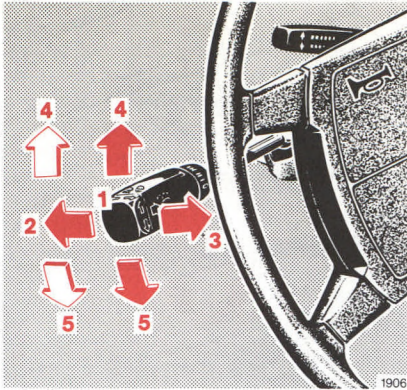

Combination Switch

- 1 Low beam (with exterior lamp switch turned to position 2)
- 2 High beam (with exterior lamp switch turned to position 2)
- 3 High beam flasher (high beam available independent of exterior lamp switch position)
- 4 Turn signals, right
- 5 Turn signals, left

To operate the turn signals, move the combination switch past the point of resistance (up or down). The switch is automatically cancelled when the steering wheel is turned to a large enough degree.

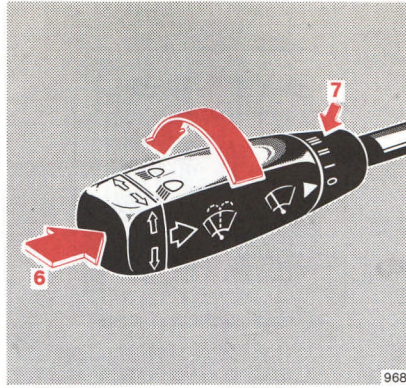

To signal minor directional changes, such as changing lanes on a highway, move combination switch to the point of resistance only and hold it there.

- 6 Control for
 - windshield washer system
 - headlamp cleaning system (will work only with exterior lamp switch in position 1 or 2)
 When the washer system is activated, the wipers also operate for a limited time. The reservoir, hoses, and nozzles of the windshield washer and headlamp cleaning system are automatically heated.

- 7 Windshield wiper control
 - 0 Wiper off
 - I Intermittent wiping
 - II Normal wiper speed
 - III Fast wiper speed

Note:

If one of the turn signals fails, the turn signal indicator system flashes and sounds at a faster rate than normal. In addition, the light failure indicator will come on.

If the windshield wipers smear the windshield, even during rain, activate the washer system as often as necessary. The fluid in the washer reservoir should be mixed in the correct ratio.

For the overload protection of the windshield wiper motor, see page 84.

Mixing ratio

For temperatures above freezing:
 MB Windshield Washer Concentrate "S" and water

1 part "S" to 100 parts water
 (40 ml "S" to 1 gallon water).

For temperatures below freezing:
 MB Windshield Washer Concentrate "S" and commercially available pre-mixed windshield washer solvent/anti-freeze

1 part "S" to 100 parts solvent
 (40 ml "S" to 1 gallon solvent).

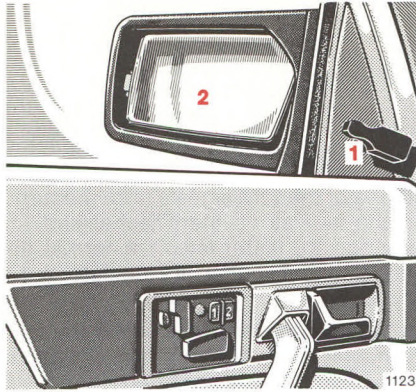

Exterior Rear View Mirrors

The exterior mirrors have electrically heated glass. The heater switches on and off automatically, depending on outside temperature.

Driver's side:

The exterior mirror (2) can be adjusted from inside the vehicle by moving adjusting lever (1) in the desired direction.

Passenger-side:

The passenger-side exterior mirror is convex (outwardly curved surface for a wider field of view).

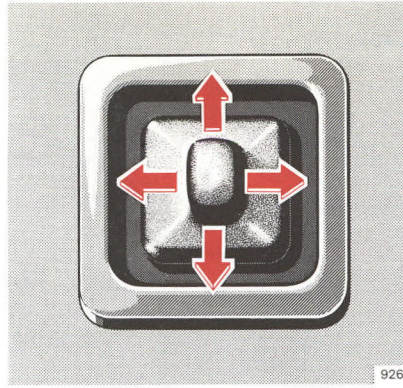

Caution!

Exercise care when using the passenger-side mirror. Objects in mirror are closer than they appear.

To adjust the mirror:

Turn key in steering lock to position 2. The exterior mirror can be adjusted using the switch. Adjust the mirror so you can just see the side of your vehicle in the portion of the mirror closest to the car.

Note:

If the mirror housing is forcibly pivoted from its normal position, it must be repositioned by applying firm pressure until it snaps into place.

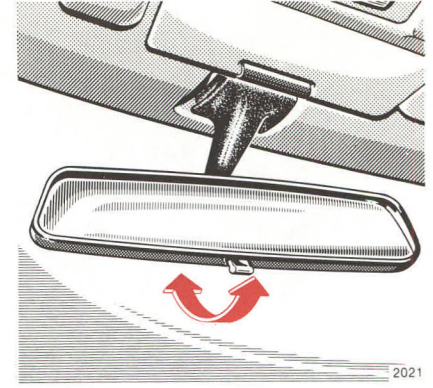

Inside Rear View Mirror

The mirror can be tilted to the anti-glare night position using the lever at its lower edge.

Use your inside mirror to determine the size and distance of objects seen in the passenger-side convex mirror.

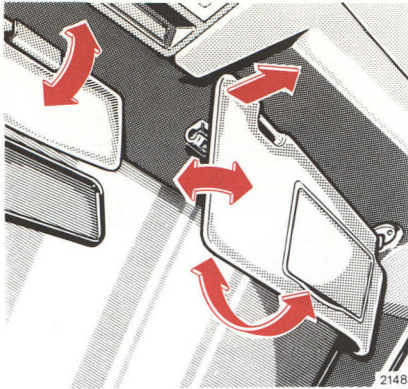

Sun Visors

Swing sun visors down to protect against sun glare.

If sunlight enters through a side window, disengage visor from inner mounting and swing to the side. From this position, the visor can slide forward and backward on its shaft.

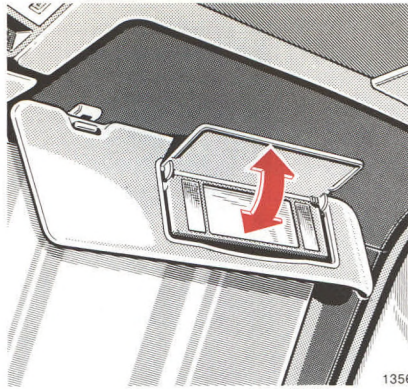

Vanity mirror:

With the visor engaged in its inner mounting, the lamp can be switched on by opening the cover.

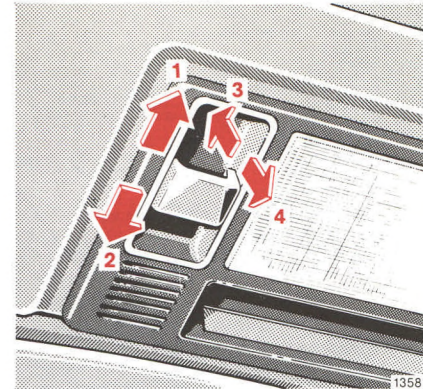

Sliding Roof with Rear Pop-Up Feature

Turn key to steering lock position 1 or 2. Activate switch.

- 1 to slide roof open
- 2 to slide roof closed
- 3 to raise roof at rear
- 4 to lower roof at rear

The switch is illuminated when the exterior lamps are switched on (except standing lamps).

The sliding roof can be opened or closed manually should an electrical malfunction occur (see page 84).



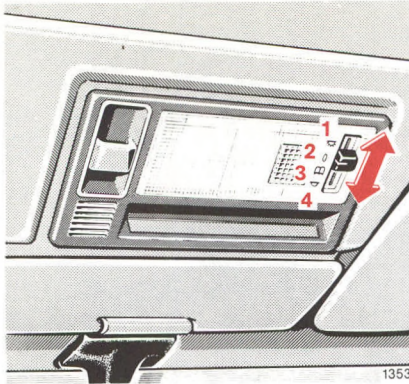

1353

Interior Lamps

The switch for the front lamp (combination interior and reading lamp) has 4 positions.

Position 1: Interior and reading lamp switched on continuously.

Position 2: Interior and reading lamp switched off continuously.

Position 3: Reading lamp switched on continuously.

Position 4: Interior lamp is switched on and off (delayed, however, there will be no delay when the key is in steering lock position 2) by the front door contact switches.



9234

The rear courtesy lamp is switched on and off by the rear door contact switches or by the rocker switch on the instrument panel.

The reading lamps in the rear passenger compartment are switched on and off by a switch in each lamp.

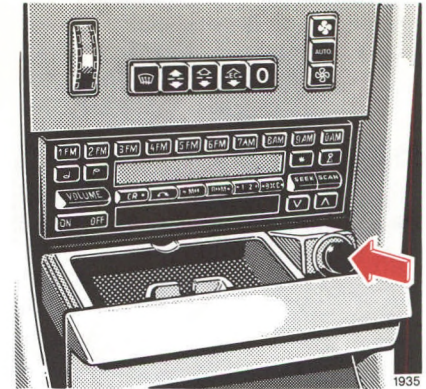

1935

Lighter

Turn key in steering lock to position 1 or 2.

Push in lighter; it will pop out automatically when hot.

Warning!

Do not touch heating element or sides of lighter, hold at knob only.

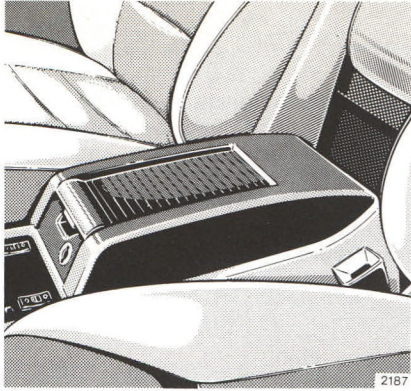

Console Storage Compartment

For vehicles with a front passenger airbag, a lockable storage compartment in the center console replaces the glove compartment in the instrument panel.



Rear Window Defroster

With engine running, press symbol side of rocker switch to turn on, bottom to turn off.

When activating the rear window defroster, the indicator lamp in the switch will come on.

Note:

The rear window defroster uses a large amount of power. To keep the battery drain to a minimum, turn off the defroster as soon as the window is clear. The defroster is automatically turned off after a maximum of 20 minutes of operation. Heavy accumulation of snow and ice should be removed before activating the defroster.

If several power consumers are turned on simultaneously, or the battery is only partially charged, it is possible that the defroster will automatically turn itself off. When this happens, the indicator lamp inside the switch starts blinking. As soon as the battery has sufficient voltage, the defroster automatically turns itself back on.

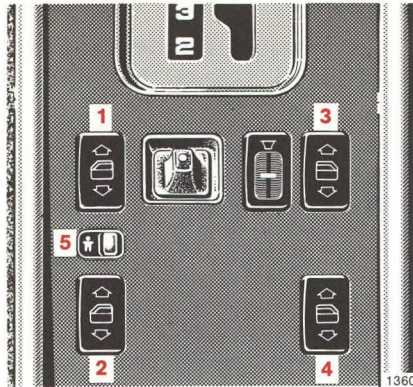

Power Windows

Switch group for power windows:

- 1 left, front
- 2 left, rear
- 3 right, front
- 4 right, rear
- 5 Safety switch

The power windows can be operated with the key in steering lock position 1 or 2.

All four windows can then be operated using the switches in the center console. The rear door windows can also be operated using the switches (6) in each rear door panel.

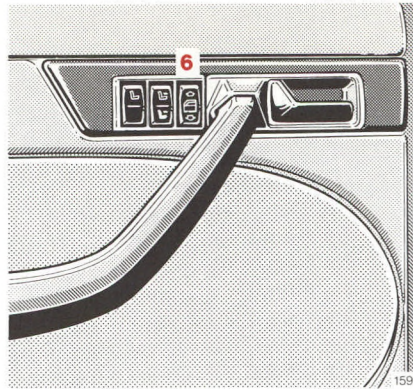

Shelf below Rear Window

Warning!

The shelf below the rear window should not be used to carry objects. This will prevent such objects from being thrown about and injuring vehicle occupants during an accident or sudden maneuver.

If inadvertent operation of the rear windows (for instance by children) is to be prevented, push safety switch (5) to the right (symbol becomes visible).

Warning!

When leaving the vehicle always remove the key from the steering lock. Do not leave children unattended in the vehicle. Unsupervised use of power windows can cause serious personal injury.

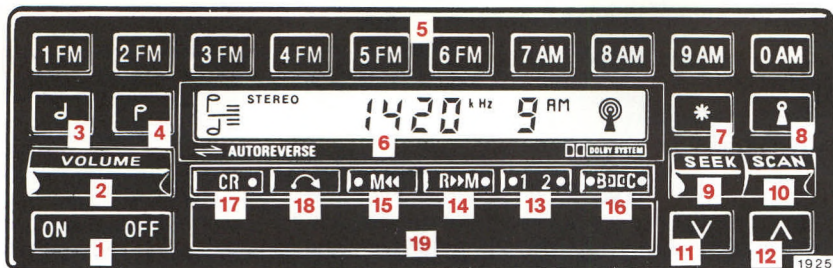

Electronic Radio

Your vehicle is equipped with the MERCEDES-BENZ sound system as standard. This system has been specially adapted to this vehicle.

Pushbutton Functions

- 1 On/Off button **ON OFF**
- 2 Volume control **VOLUME**
- 3 Bass control/left stereo balance **J**
- 4 Treble control/right stereo balance **P**
- 5 Pushbuttons for AM/FM band selection, station frequency selection, station storage **1 FM** through **0 AM**
- 6 Digital display for station frequency (a), station pushbutton number (b), AM/FM band indicator (c),

stereo indicator (d), tone setting indicator (e), tuning sensitivity indicator (f), stereo balance indicator (displayed only when balance function is activated)

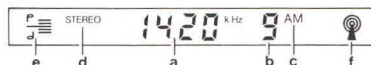

- 7 Function control *****
- 8 Tuning sensitivity **i**
- 9 Seek tuning bar **SEEK**
- 10 Scan tuning bar **SCAN**
- 11 Manual tuning **V** (decreasing station frequency)
- 12 Manual tuning **^** (increasing station frequency)
- 13 Cassette track selector with track indicator **1 2**

- 14 Reverse music search/rewind with indicator **R>M**
- 15 Forward music search/fast forward with indicator **M<<**
- 16 Dolby B and C noise reduction with indicators* **B D C**
- 17 Tape equalization with indicator **CR**
- 18 Cassette eject **EJECT**
- 19 Cassette door

To turn the radio ON

Press "ON" side of **ON OFF** button. The radio will begin operating on the last station, volume and tone setting stored before last switching it off.

The system can also be turned on by inserting a cassette through the cassette door into the unit.

To turn the radio OFF

Press the "OFF" side of the **ON OFF** button. The radio turns off automatically when the key is turned back to position 0.

* Dolby and the double-D symbol are trademarks of Dolby Laboratories Licensing Corporation.

Noise reduction system manufactured under license from Dolby Laboratories Licensing Corporation.

Volume adjustment

To reduce volume, press the volume control button **VOLUME** downward; to increase volume, press the button upward.

A fader control, located in the center console, allows for balancing the volume level between the front and rear speakers.

The left to right stereo balance may be adjusted by first pressing the function control button ***** and then pressing the bass control button **B** or the treble control button **T**. This will cause the stereo balance to shift either left or right respectively.

To center the left to right stereo balance, briefly press both buttons **B** and **T** simultaneously.

The stereo balance setting will be displayed (as shown below) when the balance feature is activated. The magnitude of the setting is shown by a number from 0 to 8. Bracketing this number are two arrows indicating the direction of the setting. For example:

- <0> = null or centered balance
- <5 = balance shifted 5 units left
- 7> = balance shifted 7 units right.

Speed-Dependent Volume Adjustment

The radio includes a special function that adjusts radio volume in respect to vehicle speed.

To adjust the tone characteristic

Bass **B** and treble **T** can be adjusted independently.

To set the radio to a "flat" tone setting (bass and treble at mid-range setting), briefly press both tone control buttons **B** and **T** simultaneously. The tone setting indicators display the selected mid-range setting:

$\frac{T}{B}$  = Mid-range Setting

Upon pressing either tone control button (either **B** or **T**), the bass or treble will increase until the respective tone control button is released or when the maximum tone level is reached.

$\frac{T}{B}$  = Maximum Treble

$\frac{T}{B}$  = Maximum Bass

After reaching the maximum tone level, the tone setting will stay at that level unless the tone control button is released and pressed again, at which point the tone level will begin decreasing. It will stop decreasing when the tone control button is released or when the minimum tone level is reached.

$\frac{T}{B}$  = Minimum Treble

$\frac{T}{B}$  = Minimum Bass

After reaching the minimum tone level, the tone setting will stay at that level unless the tone control button is released and pressed again. After pressing the tone control button again the tone level will begin to increase and the cycle is repeated.

Note: It takes approx. 5 seconds to go from minimum tone level to maximum tone level.

This radio has 3 tone setting memories, one each for AM, FM and cassette. The individual tone setting for each mode will be automatically stored.

To select AM or FM

Press any of the buttons marked **1 FM** through **6 FM** to tune the radio to the FM band.

Press any of the buttons marked **7 AM** through **0 AM** to tune the radio to the AM band.

The selected wave band is indicated in the digital display.

To tune-in a station

Stations can be tuned-in by using seek/scan tuning, direct frequency tuning, manual tuning, or by preset pushbuttons. The frequency of the station selected is indicated in the digital display.

Seek tuning

Switch to the desired wave band, press the seek tuning bar **SEEK** upward to automatically seek stations in ascending frequencies, press downward to do so in descending frequencies. In order to arrive at a desired station without stopping, the bar must be held in the desired direction.

The direction of seek tuning can be reversed by pressing the bar **SEEK** in the respective direction.

Scan tuning

Switch to AM or FM, then press the scan tuning bar **SCAN** to automatically tune to the first station broadcasting within the selected reception sensitivity level. This station is held for "audition" for approx. 5 seconds. If desired, this station may be locked in by pressing the **SCAN** or **SEEK** bar. If neither of the bars is pressed, the radio will continue to scan to each station within the selected sensitivity level and "audition" each station for approx. 5 seconds.

By pressing the scan tuning bar **SCAN** upward the radio will scan stations in ascending frequencies, by pressing downward it will do so in descending frequencies.

Tuning sensitivity button

By pressing the tuning sensitivity button **📶** once or twice, you can select the desired sensitivity level for seek/scan tuning. The sensitivity indicator displays the selected sensitivity level:

- 📶** = least sensitive (the automatic station seeker/scanner stops only at strong stations)
- 📶** = average (the automatic station seeker/scanner stops at strong and moderate strength stations)
- 📶** = most sensitive (the automatic station seeker/scanner also stops at weak stations)

If no stations are located by the seek or scan functions during one complete pass through the selected wave band, the tuning sensitivity will automatically switch to the next higher sensitivity level and be indicated as shown above.

When switched off, the radio returns to the "least sensitive" level.

Note: The tuning sensitivity button has no influence on reception quality, only on the sensitivity of station selection during the automatic station seeker/scanner modes.

Direct frequency tuning

In order to select a station with a known frequency, select the wave band (AM or FM), press the function control button ***** and then enter the frequency by pressing the corresponding pushbuttons.

Example:

Press any button marked

Press the function control button

Enter frequency by pressing

FM 98.5 MHz			AM 1050 kHz			
1 FM	through	6 FM	7 AM	through	0 AM	
*			*			
9 AM	8 AM	5 FM	1 FM	0 AM	5 FM	0 AM

When tuning a frequency directly, the pushbutton number is not displayed on the panel. The wave band is indicated by showing “MHz” for FM or “kHz” for AM.

Note:

All AM stations have allocated frequencies ending with a “0”.

All FM stations have allocated frequencies ending with an odd-numbered digit following the decimal point.

Broadcasters sometimes may not give their exact frequency but the next closest whole number.

US radio frequency ranges:

AM 540 – 1600 kHz

FM 88.1 – 107.9 MHz

Please note: It is recommended that direct frequency tuning operations be performed by the driver only while the vehicle is not moving. The driver should use the automatic station seeker/scanner or pushbutton tuning when the vehicle is in motion.

Manual tuning

(For fine tuning a station or for manual tuning)

After selecting the desired AM or FM wave band, press the manual tuning button **▼** (decreasing station frequency) or **▲** (increasing station frequency).

The frequency will increase or decrease respectively in increments of 0.1 MHz for FM or 1.0 kHz for AM. Release the button when the desired station is tuned in.

Pushbutton tuning

Six FM stations and four AM stations can be stored in memory and recalled by pressing the appropriate buttons marked **1 FM** through **6 FM** for FM or **7 AM** through **0 AM** for AM stations.

To store stations in memory

Any FM station can be stored on any button marked **1 FM** through **6 FM** by first tuning in the desired station, depressing the button desired and holding it until the display has changed from the “old” setting to a “blank” and then to the new station to be stored.

Showing the “old” setting first allows for reconsideration of the decision to store. If it is desirable to leave the “old” station in memory rather than exchanging it with the “new” one, quickly release the button. The “old” station will remain in memory.

Any AM station can be stored similarly on any button marked **7 AM** through **0 AM**.

Stereo reception

The stereo indicator **STEREO** lights up if a stereo program in the AM or FM band is received.

Note: The radio receives AM stereo programs which are broadcast via the C-Quam®* AM stereo system.

The radio is equipped with an automatic stereo/mono blend switch that electronically switches to mono for clear reception if a weak signal is received.

The stereo indicator will remain lit even if the receiver has changed to the mono mode and will turn off at an antenna signal considered insufficient to provide acceptable reception quality.

Although FM is normally static free, reception quality can be limited by geographic and atmospheric conditions, station strength and distance from the transmitter. Buildings or other obstructions can cause momentary static, flutter or station swapping. If good reception cannot be obtained, tune to a stronger station.

In the event that it is important to listen to a weak station or to a strong station that is masked by terrain-induced noise or interference problems, the following steps can be taken to increase the listenability of the station.

Fringe area AM and FM reception of weak stations can be improved by first insuring that the antenna is at its maximum height and then reducing the treble and bass settings as required to filter out as much background noise as is needed.

FM noise problems that are caused by urban and hilly conditions may be reduced by lowering the treble setting until the pops and hisses associated with this type of terrain are reduced to acceptable levels.

AM reception difficulties caused by strong adjacent stations or nighttime atmospheric conditions may be reduced by fine tuning the selected station with the two fine tuning buttons.

The tuning sensitivity button **i** has no influence on reception quality.

* C-Quam® is a registered trademark of Motorola, Inc.

TAPE CASSETTE PLAYBACK

Cassette player operation

It is recommended to use only high quality cassettes with a playback time of not more than 90 minutes (C 90).

To play a cassette, insert the cassette (tape side first, side "1" or "A" facing up) through the cassette door. Gently push the cassette into the slot until the motorized-loading system engages the cassette. The unit will then switch from radio to cassette playback.

Automatic tape tensioning will take up any possible tape slack before the beginning of playback.

A switched-off unit can be automatically turned-on by loading a cassette.

Track selection

When the end of the first track is reached, the unit automatically reverses to play the second track. The tape track can also be selected by briefly pressing the cassette track selector button **1 2**. The track selected is indicated by the respective indicator lamp in the button.

Forward music search/fast forward

To engage the forward music search feature, press the forward music search/fast forward button **M<<** once. The forward music search begins to advance the tape to the next music selection. The indicator lamp in the button **M<<** lights up. There must be a minimum pause of 4 seconds between selections for the music search feature to determine the beginning of the next music selection.

Music search can be interrupted by pressing the reverse music search/rewind **R>>M**, track selector **1 2** buttons or by pressing the forward music search/fast forward button **M<<** again after approx. 3 seconds.

To fast forward the tape, press the forward music search/fast forward button **M<<** twice. The indicator lamp in the button **M<<** blinks. Upon reaching the end of the tape, the unit will automatically reverse to play the other track.

Fast forward can be interrupted by pressing the reverse music search/rewind **R>>M**, track selector **1 2** buttons or by pressing the forward music search/fast forward button **M<<** again after approx. 3 seconds.

Reverse music search/rewind



To engage the reverse music search feature, press the reverse music search/rewind button **R>>M** once. The reverse music search begins to rewind the tape to the previous music selection. The indicator lamp in the button **R>>M** lights up. There must be a minimum pause of 4 seconds between selections for the music search feature to determine the beginning of the previous music selection.

Music search can be interrupted by pressing the forward music search/fast forward **M<<** or track selector **1 2** buttons and by pressing the reverse music search/rewind button **R>>M** again after approx. 3 seconds.



To rewind the tape, press the reverse music search/rewind button **R>>M** twice. The indicator lamp in the button **R>>M** blinks. Upon reaching the beginning of the tape, the unit will automatically replay the same track. The unit will not reverse to the other track.

Rewind can be interrupted by pressing the forward music search/fast forward **M<<** or track selector **1 2** buttons and by pressing the reverse music search/rewind button **R>>M** again after approx. 3 seconds.

Dolby B and C noise reduction

To replay cassettes recorded using the Dolby B or C noise reduction systems, press the Dolby NR button  repeatedly until the desired type of Dolby noise reduction (Dolby B or Dolby C) is attained. This reduces tape hiss. The indicator lamps in the button indicate the type of Dolby noise reduction selected. To replay cassettes not recorded in Dolby, press the button  repeatedly until the indicator lamps in the button  go out.

Tape equalization

For optimum reproduction quality it is necessary to select the correct tape equalization for the particular type of tape being used. Press the tape equalization button  only when playing Chromium dioxide (CRO₂) or "metal" cassette tapes. The indicator lamp in the button will illuminate when CRO₂ or metal equalization has been selected. For all other types of tape, do not press the tape equalization button . The indicator lamp in the button  remains off.

Cassette eject

To remove a cassette, press the eject button . Remove the tape after the motorized-loading system has disengaged the cassette. The unit will automatically switch from cassette playback to radio operation.

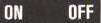
When the unit is turned off by pressing the "OFF" side of the On/Off button  or by turning the key to steering lock position 0, the cassette will automatically eject.

Care and maintenance

To avoid deterioration of the tone quality, periodically clean the tape head with the special cleaning tape kit available at your authorized MERCEDES-BENZ dealer.

Cassette tapes should be properly stored when not in use. It is recommended that cassettes be stored in a cassette box designed to prevent unwinding and the accumulation of dust.

If the cassette ejects during playback, this may be caused by binding of the tape in the cassette. To eliminate this condition, fast forward the cassette to the end of the track and then rewind to the beginning of the track.

Protect cassette tapes from direct sunlight or other temperature extremes.

Radio anti-theft protection

Removal of the radio with the vehicle anti-theft alarm armed will render the radio inoperative indicated by a dashed line across the display.

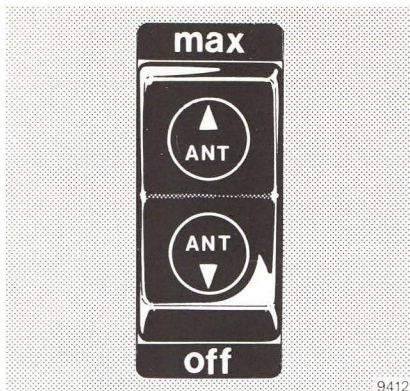

Automatic Antenna

The antenna switch can be actuated with the radio switched on.

- If the antenna switch is engaged in the "max" position, the antenna extends fully.

Note:

For most conditions the antenna should normally be in this position.

- If the antenna switch is in the center position, the antenna extends automatically to medium height,
- if the antenna switch is engaged in the "off" position, the antenna will not extend or will retract completely.

The height of the antenna can be adjusted to any intermediate position by actuating the antenna switch:

- If the antenna switch is in the center position, the antenna will extend to medium height. The antenna can be further extended or retracted to any height by rocking the switch (not engaging it).
- If the antenna is to be retracted, e.g. going through car wash, etc., engage switch in "off" position.

When the key is turned to steering lock position 0 or the radio is turned off, the antenna will retract completely.

Driving

Parking Brake	60
Automatic Transmission	60
Cruise Control	63
Charge Indicator Lamp	64
Oil Pressure Gauge	64
Low Engine Oil Level Indicator Lamp	64
Engine Oil Consumption	64
Coolant Temperature Gauge	64
Low Engine Coolant Level Indicator Lamp	64
Fuel Reserve Warning Lamp	65
Low Windshield and Headlamp Washer Fluid Level Indicator Lamp	65
Exterior Light Failure Indicator Lamp	65
Outside Temperature Indicator	65
Brake Pad Wear Indicator Lamp	66
Brake Warning Lamp	66
ABS (Antilock Brake System)	66
Emission Control	67
On-Board Diagnostic System (California models only)	67
Economical Driving Indicator (ECONOMY)	68
Traveling Abroad	68
Winter Driving	68
Tire Chains	68

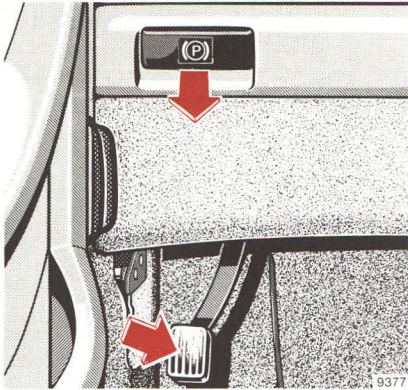

Parking Brake

To engage, depress parking brake pedal. When the key is in steering lock position 2, the brake warning lamp in the instrument cluster should come on brightly (function check for brake warning lamp).

To release the parking brake, pull handle on instrument panel. The brake warning lamp in the instrument cluster should dim.

Automatic Transmission

The automatic transmission selects individual gears automatically, depending upon selector lever position, vehicle speed and accelerator position.

Warning!

Keep driver's foot area clear at all times. Objects stored in this area may impair pedal movement.

Driving:

Shift selector lever to the desired driving position only when the engine is idling and the service brake is applied. Do not release the brake until ready to drive. The vehicle may otherwise start creeping when the selector lever is in a drive position.

Test the brakes briefly after driving off. Perform this procedure only when the road is clear of other traffic.

Warm up the engine smoothly. Do not place full load on the engine until the operating temperature has been reached.

When starting off on a slippery surface, do not allow one driving wheel to spin for an extended period.

Accelerator position

Partial throttle = early upshifting = normal acceleration.

Full throttle = later upshifting = maximum acceleration.

Depressing the accelerator beyond full throttle to kickdown position means downshifting to the next lower gear and thereby increasing acceleration. If you ease up on the accelerator after having attained the desired speed, the transmission will shift up again.

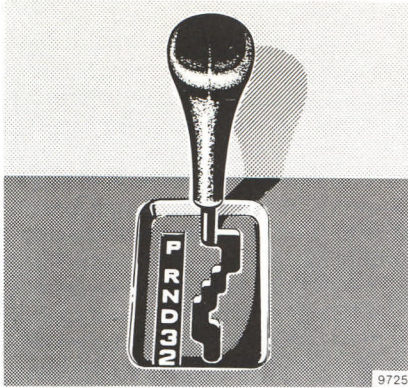

Selector lever positions

The automatic gear shifting process can be adapted to specific operating conditions using the selector lever.

- “P” Parking lock.
The parking lock is an additional safeguard to the parking brake when parking the vehicle. Engage only with the car stopped.
- “R” Reverse gear.
Shift to reverse gear only with the car stopped.
- “N” Neutral.
No power is transmitted from the engine to the rear axle. When the brakes are released, the vehicle can be moved freely (pushed, towed or tow-started). Do not engage “N” while driving except when the vehicle is in danger of skidding (e.g. on icy roads, see page 18).
- “D” Drive.
Automatic upshifting to top gear. Position “D” affords optimum driving characteristics under all normal operating conditions.
- “3” Upshift to 3rd gear only. Suitable for medium range up or down-grades.
- “2” Upshift to 2nd gear only. For driving in mountainous regions. Since transmission will not shift up further, this gear selection will make use of the engine’s braking power.



Important!

Do not exceed the engine speed limits for individual gear selections, which are indicated by marks on the speedometer.

Do not attempt downshifting to a lower gear (braking effect) unless the speedometer needle is below the speed limit mark of that particular gear range. Overrevving could result in damage to the engine.

On slippery road surfaces, it is not recommended to downshift in order to obtain braking action. This could result in rear wheel slip and reduced vehicle control.

To prevent the engine from laboring at low RPMs, do not allow the engine speed to drop too low on uphill gradients. Depending on the degree of the incline, shift selector lever to positions "3" or "2" early enough to maintain engine RPM within the best torque range.

Stopping

For brief stops, e. g. at traffic lights, leave the transmission engaged and control vehicle with the service brake.

For longer stops with the engine idling, shift into "N" or "P".

When stopping the car on an incline, do not hold it with the accelerator, use the brake. This avoids unnecessary transmission heat build up.

Maneuvering

To maneuver in tight areas, e.g. when pulling into a parking space, control the car speed by gradually releasing the brakes. Accelerate gently and do not pump the accelerator.

To rock a car out of soft ground (mud or snow), alternately shift from forward to reverse, while applying partial throttle.

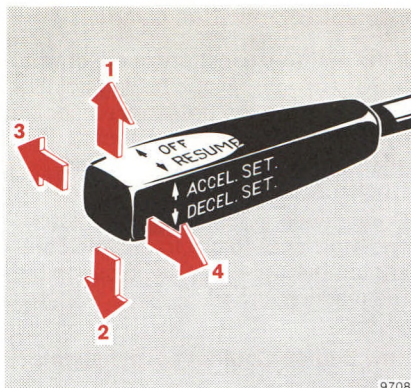

Cruise Control

Any given speed above approximately 40 km/h (25 mph) can be maintained with the cruise control by operating the lever.

- 1 Accelerate and set:
Lift lever briefly to set speed.
Hold lever up to accelerate.
- 2 Decelerate and set:
Depress lever briefly to set speed.
Hold lever down to decelerate.

Normally the vehicle is accelerated to the desired speed with the accelerator. Speed is set by briefly pushing the lever to position 1 or 2. The accelerator can then be released.

The speed can be increased (e.g. for passing) by using the accelerator. As soon as the accelerator is released, the previously set speed will be resumed automatically.

If a set speed is to be increased or decreased slightly, e.g. to adapt to the traffic flow, hold lever in position 1 or 2 until the desired speed is reached, or briefly tip the control lever in the appropriate direction for increases or decreases in 1 km/h (0.6 mph) increments. When the lever is released, the newly set speed remains.

- 3 Cancelling
To cancel the cruise control, briefly push lever to position 3. When you step on the brake pedal or the vehicle speed falls below approx. 40 km/h (25 mph), for example when driving upgrade, the cruise control will be cancelled.
- 4 Resume
If the lever is briefly pulled to position 4 when driving at a speed exceeding approximately 40 km/h (25 mph), the vehicle resumes the speed which was set prior to the cancellation of the cruise control. The last memorized speed is cancelled when the key is turned to steering lock position 1 or 0.

Note:

If the engine does not brake the vehicle sufficiently while driving on a downgrade, the speed you set on the cruise control may be exceeded. As soon as the grade eases, the cruise controlled speed will again be maintained as long as the brakes were not applied.

If the set speed was sufficiently exceeded such that the brakes had to be applied, the cruise control can be resumed by pulling the lever to position 4.

Warning!

Only use the cruise control if the traffic and weather conditions make it advisable to travel at a steady speed.

The "Resume" function should only be operated if the driver is fully aware of the previously set speed and wishes to resume this particular preset speed.

When driving with the cruise control, the transmission selector lever must not be shifted to position "N" as otherwise the engine will overrev.

Charge Indicator Lamp

Should the charge indicator lamp fail to come on prior to starting when the key is in steering lock position 2 or should it fail to go out after starting or during operation, this indicates a fault which must be repaired at an authorized MERCEDES-BENZ dealer as soon as possible.

If the charge indicator lamp comes on while the engine is running, this may indicate that the poly-V-belt has broken. Should this condition occur, the poly-V-belt must be replaced before continuing to operate the vehicle. Otherwise, the engine will overheat due to an inoperative water pump which may result in damage to the engine.

Oil Pressure Gauge

The oil pressure at idle speed may drop to 0.3 bar (4.4 psi) if the engine is at operating temperature. This will not jeopardize its operational reliability.

Pressure must, however, rise immediately upon acceleration.

Low Engine Oil Level Indicator Lamp

The indicator lamp comes on with the key in steering lock position 2 and should go out when the engine is running.

If the indicator lamp comes on with the engine running and at operating temperature, the engine oil level has dropped to approximately the minimum mark on the dipstick. When this occurs, the indicator lamp will first come on intermittently and then stay on if the oil level drops further. If no oil leaks are noted and there is no loss in engine oil pressure, continue to drive to the nearest service station where the engine oil should be topped to the "full" mark of the dipstick (see page 72).

In addition to the indicator lamp, the engine oil level should be periodically checked with the dipstick, for example during a fuel stop, or before a long trip (see page 72).

Engine Oil Consumption

Engine oil consumption can only be determined after a certain mileage has been covered. During the break-in period, higher oil consumption may be noticed and is normal.

Coolant Temperature Gauge

If the antifreeze mixture is effective to $-30\text{ }^{\circ}\text{C}$ ($-22\text{ }^{\circ}\text{F}$) the boiling point of the coolant in the pressurized cooling system of your vehicle is approx. $130\text{ }^{\circ}\text{C}$ ($266\text{ }^{\circ}\text{F}$) (see also "Fuels, Coolants, Lubricants, etc.").

During severe operating conditions and stop-and-go city traffic, the coolant temperature may rise close to the red marking.

Low Engine Coolant Level Indicator Lamp

The indicator lamp comes on with the key in steering lock position 2, and should go out when the engine is running.

If it comes on with the engine running, the coolant has dropped below the required level. If no leaks are noticeable and the engine temperature does not increase, continue to drive to the nearest service station and have coolant added to the coolant system (see page 71).

Fuel Reserve Warning Lamp

The fuel reserve warning lamp will come on when the key is turned to steering lock position 2, and will go out after the engine is running.

If the warning lamp stays on after the engine starts, or comes on while driving, it indicates that the fuel level is down to the reserve quantity (12.5 l [3.3 US gal]).

Low Windshield and Headlamp Washer Fluid Level Indicator Lamp

The indicator lamp comes on with the key in steering lock position 2 and should go out when the engine is running.

If the indicator lamp comes on with the engine running, the level of the reservoir has dropped 1/3 of the total volume. The reservoir should be refilled with MB Windshield Washer Concentrate "S" and water (or commercially available premixed windshield washer solvent/anti-freeze, depending on ambient temperature) at the next opportunity. The reservoir for the windshield and headlamp washer system is located in the engine compartment (see page 112).

Exterior Light Failure Indicator Lamp

With the key in steering lock position 2, a dim indicator lamp comes on and must go out with the engine running.

With the key in steering lock position 2 or with the engine running, a bright illumination of this lamp indicates an exterior lamp failure.

If an exterior light fails, the indicator will come on only when that light is switched on.

If a brake or turn signal light fails, the light failure indicator will come on when applying the brake or actuating the turn signal and stay on until the engine is turned off.

Caution!

The indicator lamp will also come on if an incorrect bulb is installed.

If additional lighting equipment is installed (e.g. auxiliary headlamps etc.) be certain to connect into the fuse before the failure indicator monitoring unit in order to avoid damaging the system.

Outside Temperature Indicator

The temperature sensor is located in the front bumper area. Due to its location, the sensor can be affected by road or engine heat during idling or slow driving. This means that the accuracy of the displayed temperature can only be verified by comparison to a thermometer placed next to the sensor, not by comparison to external displays (e.g., bank signs, etc.).

Adaptation to ambient temperature takes place in steps and depends on the prevailing driving conditions (stop and go or moderate, constant driving) and amount of temperature change.

Warning!

The outside temperature indicator is not designed to serve as an Ice-Warning-Device and is therefore unsuitable for that purpose. Indicated temperatures just above freezing point do not guarantee that the road surface is free of ice.

Brake Pad Wear Indicator Lamp

The brake pad wear indicator lamp in the instrument cluster comes on when the key is turned to steering lock position 2 and it should go out when the engine is running. If the indicator lamp lights up during braking, this shows that the front wheel brake pads are worn.

Have the brake system checked at your authorized MERCEDES-BENZ dealer as soon as possible.

Brake Warning Lamp

The brake warning lamp will come on if insufficient brake fluid is in the reservoir (key in steering lock position 2 and parking brake released). When the minimum mark on the reservoir is reached, have the brake system checked for brake pad thickness and leaks.

To test the brake warning lamp, turn key in steering lock to position 2. The brake warning lamp comes on, and should go out when the engine is running.

ABS (Antilock Brake System)

The ABS prevents the wheels from locking up above a vehicle speed of approximately 3 km/h (2 mph) independent of road surface conditions. It is necessary, however, that the vehicle speed reaches at least 8 km/h (5 mph) before commencing to brake. At the instant one of the wheels is about to lock up, you will feel a slight pulsation in the brake pedal, indicating that the ABS is in the regulating mode.

On slippery road surfaces, the ABS will respond even with only slight brake pedal pressure. The pulsating brake pedal can be an indication of hazardous road conditions, and it functions as a reminder to take extra care while driving.

The ABS indicator lamp in the instrument cluster comes on with the key in steering lock position 2 and should go out with the engine running.

If the charging voltage falls below 10 volts, the indicator lamp comes on and the ABS is switched off. When the voltage is above this value again, the indicator lamp should go out and the ABS will be operational.

If the ABS indicator lamp does not go out or comes on while driving, it indicates that the ABS has detected a malfunction and has switched off. In this case, the brake system functions in the usual manner, but without anti-lock assistance. We recommend that you visit an authorized MERCEDES-BENZ dealer as soon as possible to have the system checked.

Warning!

Even the ABS cannot prevent the natural laws of physics from acting on the vehicle. The ABS cannot prevent accidents, including those resulting from excessive speed in turns, following another vehicle too closely, or aquaplaning. Only a safe, attentive, and skillful driver can prevent accidents. The capabilities of an ABS equipped car must never be exploited in a reckless or dangerous manner which could jeopardize the user's safety or the safety of others.

Emission Control

Certain systems of the engine serve to keep the toxic components of the exhaust gases within permissible limits required by law.

These systems, of course, will function properly only when maintained strictly according to factory specifications. Any adjustments on the engine should, therefore, be carried out only by qualified MERCEDES-BENZ technicians. The adjustments of the engine should not be altered in any way. Moreover, the specified service and maintenance jobs must be carried out regularly according to MERCEDES-BENZ servicing requirements. For details refer to the Maintenance Booklet.

Warning!

Inhalation of exhaust gas is hazardous to your health. All exhaust gas contains carbon monoxide, and inhaling it can cause unconsciousness and lead to death.

Do not run the engine in confined areas (such as a garage) which are not properly ventilated. If you think that exhaust gas fumes are entering the vehicle while driving, have the cause determined and corrected immediately. If you must drive under these conditions, drive only with at least one window fully open.

On-Board Diagnostic System (California models only)

The CIS-E control unit monitors emission control components that either provide input signals to or receive output signals from the control unit. Malfunctions resulting from interruptions or failure of any of these components are indicated by the "CHECK ENGINE" indicator lamp in the instrument cluster and are simultaneously stored in the CIS-E control unit.

If the "CHECK ENGINE" indicator lamp comes on, have the system checked at your authorized MERCEDES-BENZ dealer at the first opportunity.

An on-board test connection with pushbutton and light emitting diode (LED) is located on the engine compartment firewall, allowing the accurate detection of system malfunctions.

Economical Driving Indicator (ECONOMY)

The indicator shows the fuel consumption tendency during various driving modes.

High fuel consumption is indicated if the pointer moves into the red area; economical driving is indicated when it is in the black area. The indications should only be compared when driving within the same gear.

Do not compare fuel consumption readings between different gears. The following rule applies: If you drive at equal speeds, the fuel consumption is lower in the higher gear, although in this gear the pointer is more frequently in the red area.

Traveling Abroad

Abroad, there is a widely-spread MERCEDES-BENZ service network at your disposal. If you plan to travel into areas which are not listed in the index of your dealer directory, you should request pertinent information from your authorized MERCEDES-BENZ dealer.

Winter Driving

Have your car winterized at your authorized MERCEDES-BENZ dealer before the onset of winter.

- Engine oil change: If “year-round” multigrade engine oil is not used, be sure to use an SAE grade based on ambient temperature. For recommended engine oil viscosities refer to “Fuels, Coolants, Lubricants, etc.” and last page.
- Check engine coolant anticorrosion/antifreeze concentration.
- Additive for the windshield washer and headlamp cleaning system: Add MB Concentrate “S” to the premixed windshield washer solvent/anti-freeze which is formulated for below freezing temperatures (see page 45).
- Test battery: Battery capacity drops with decreasing ambient temperature. A well charged battery ensures that the engine can always be started, even at low ambient temperatures.
- Tires: We recommend M + S radial tires on all four wheels for the winter season. Observe permissible maximum speed for M + S radial tires and the legal speed limit.

Tire Chains

Use only tire chains that are tested and recommended by MERCEDES-BENZ. Your authorized MERCEDES-BENZ dealer will be glad to advise you on this subject.

Chains should only be used on the rear wheels. Adhere to the manufacturer’s mounting instructions.

After driving a short distance retighten the mounted chains.

Tire chains should only be driven on snow at speeds not to exceed 50 km/h (30 mph). Remove chains as soon as possible when driving on roads without snow.

For tips on driving on slippery winter roads refer to page 18.

Practical Hints

Hood	70	Emergency Operation of	
Checking Coolant Level	71	Sliding Roof	84
Adding Coolant	71	Manual Release of Fuel Filler Flap	84
Engine Oil Level Check	72	Windshield Wipers	84
Fluid Level-Automatic		Replacing Wiper Blades	85
Transmission	73	Towing the Vehicle	86
First Aid Kit	74	Jump Starting	87
Stowing Things in the Vehicle	74	Cleaning and Care of the Vehicle	88
Spare Wheel	74	Rear Seat Cushion	91
Vehicle Tools	74	Ashtrays	91
Vehicle Jack	75	Head Restraints	92
Wheels, Tires	75	Luggage or Ski Racks	93
Changing Wheels	77	Spare Parts Service	93
Tire Inflation Pressure	78	Layout of Poly-V-belt Drive	93
Battery	79		
Headlamp Adjustment	80		
Replacing Bulbs	80		
Spark Plugs	82		
Fuses	83		

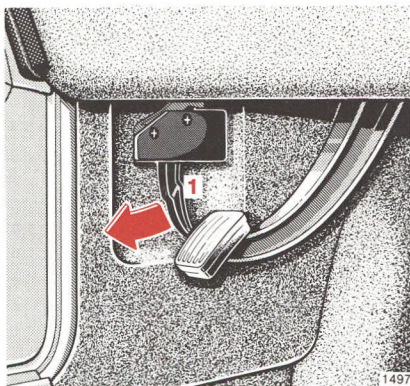

Hood

To open:

To unlock the hood, pull release lever (1) under the driver's side of the instrument panel. At the same time handle (2) will pop out of the radiator grill (it may be necessary to lift the hood up slightly).

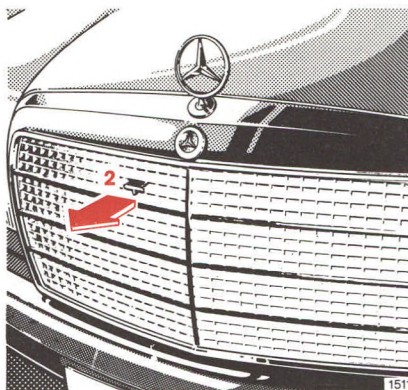

Pull handle (2) completely out of radiator grill and open hood (do not pull up on handle).

Caution!

To avoid damage to the windshield wipers or hood, open the hood only with wipers in the parked position.

To close:

Close hood by depressing it firmly.

Warning!

To help prevent personal injury, stay clear of moving parts when the hood is open and the engine is running. Be sure the hood is properly closed before driving.

The engine is equipped with a transistorized ignition system. Because of the high voltage it is dangerous to touch any components (ignition coil, distributor, spark plug sockets, ignition cables, diagnostic socket) of the ignition system

- if the ignition is "on" and the engine turned manually
- while starting the engine
- with the engine running.

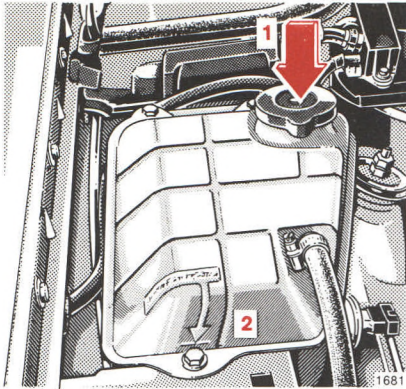

- 1 Coolant reservoir cap
- 2 Marking for coolant level

Checking Coolant Level

The coolant level can be checked visually at the transparent coolant reservoir.

To check the coolant level, the vehicle must be parked on level ground.

The coolant level must reach:

The marking (2, arrow) on the reservoir when the engine is cold.

Approx. 2 cm (0.8 in) higher when the engine is at operating temperature.

Adding Coolant

If coolant has to be added, a 50/50 mixture of water and MB anticorrosion/antifreeze should be used.

Warning!

- Use extreme caution when opening the hood, if there are any signs of steam or coolant leaking from the cooling system.
- Do not remove pressure cap on coolant reservoir if engine temperature is above 90 °C (194 °F). Allow engine to cool down before removing cap. The coolant reservoir contains hot fluid and is under pressure.
- Using a rag, turn cap to first notch to relieve excess pressure. If opened immediately, hot scalding fluid and steam will be blown out under pressure.

The drain plugs are located on the right side of the engine and on the radiator bottom.

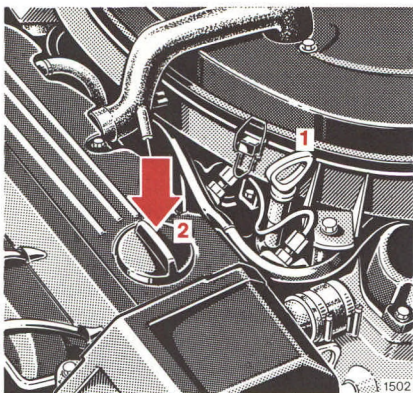

- 1 Oil dipstick
- 2 Oil filler cap

Engine Oil Level Check

The best time to check the engine oil level is when the oil is warm, such as during a fuel stop.

With the vehicle on level ground, stop the engine and wait a few minutes for the oil to drain back to the oil pan.

Wipe the dipstick clean before checking.

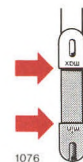

Add oil, if needed, only to the upper mark (max). Do not overfill the engine.

For viscosity and capacity, see "Fuels, Coolants, Lubricants, etc." and last page.

For low engine oil level indicator lamp, see page 64.

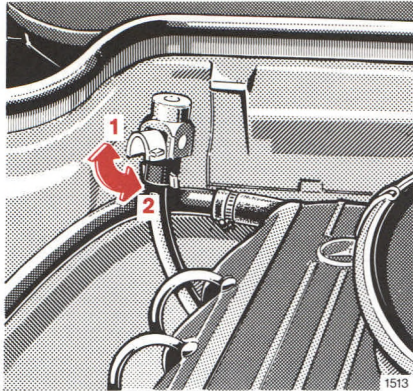

Fluid Level – Automatic Transmission

Check the fluid level in the automatic transmission regularly and prior to an extended trip.

Check transmission fluid level with the engine idling, parking brake engaged and selector lever in position “P”. The vehicle must be parked on level ground. Prior to the check, allow engine to idle for approx. 1 to 2 minutes.

Measure fluid level with the dipstick completely inserted and the locking lever released (1).

Extreme cleanliness must be observed! To wipe the dipstick, use a clean, lint-free cloth. To fill the transmission with fluid, pour it through a fine-mesh filter into the dipstick opening. Even the slightest impurity may cause operational troubles.

The fluid level in the transmission is dependent upon its temperature. The maximum and minimum fluid level marks on the dipstick are applicable references only if the transmission fluid has reached its normal operating temperature of 80 °C (176 °F).

Important!

If the transmission fluid cools down to 20 – 30 °C (68 – 86 °F), which is the normal shop temperature range, then the maximum fluid level will be approximately 10 mm (0.4 in) below the minimum mark on the dipstick. We stress this point because a fluid change is normally performed when the transmission fluid has cooled down to shop temperature.

The fluid level must not exceed the dipstick maximum mark with the fluid at operating temperature. Drain or siphon off excess fluid, if required. Then push dipstick all the way in and swing locking lever downwards (2).

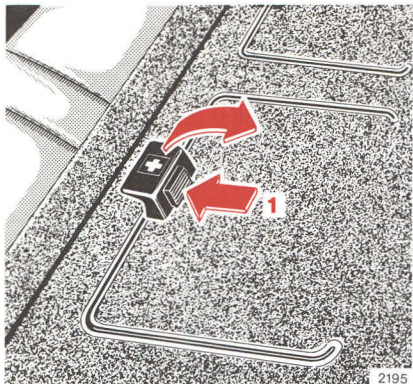

First Aid Kit

The first aid kit is stored in the shelf below the rear window. To open the lid, push button (1).

Stowing Things in the Vehicle

Warning!

To help avoid personal injury during a collision or sudden maneuver, exercise care when stowing things. Put luggage or cargo in the trunk if possible. Do not pile luggage or cargo higher than the seat backs. Do not place anything on the shelf below the rear window.

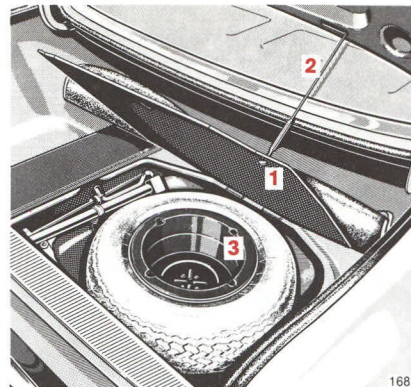

Spare Wheel

Roll back the floor mat, lift the trunk floor (1) and engage strap (2) in the trunk lid.

To remove the spare tire, turn luggage bowl (3) to the left and remove.

Vehicle Tools

The vehicle tools are located in the spare wheel well.

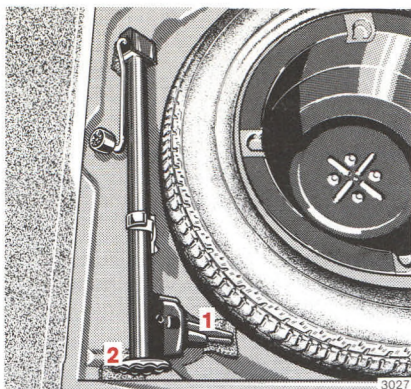

Vehicle Jack

See illustration for proper storage of jack.

Before storing the jack, the jack arm (1) must be lowered almost to the base (2) of the jack and should rest on the felt in the spare wheel well.

Warning!

The jack is designed exclusively for jacking up the vehicle at the jack tubes built into either side of the vehicle. Use the jack only to lift the vehicle during a wheel change. Never get beneath the vehicle while it is supported by the jack. Keep hands and feet away from the area under the lifted vehicle. Always firmly set parking brake and block wheels before raising vehicle with jack.

Do not disengage parking brake while vehicle is raised. Be certain that the jack is always vertical when in use, especially on hills. Lower the vehicle onto sufficient capacity jackstands before working under the vehicle.

Wheels, Tires

Replace wheels or tires with the same designation, manufacturer and type as shown on the original part. See your authorized MERCEDES-BENZ dealer for further information.

Warning!

Do not mix different tire construction types (i.e. radial, bias, and biasbelted) on your car because handling may be adversely affected and may result in loss of control.

See your authorized MERCEDES-BENZ dealer for information on tested and recommended wheels and tires for summer and winter operation. They can also offer more advice concerning tire service and purchase. Front tires should be replaced in sets. If possible, the spare tire should be used on the rear wheels. We recommend that you break in new tires for approx. 100 km (60 miles) at moderate speed.

It is imperative that the wheel mounting bolts be retightened after approx. 800 km (500 miles).

On new vehicles retightening is carried out during the 1st inspection. Retightening is also necessary whenever wheels are fitted, e.g. when the spare wheel is used for the first time or when a set of wheels with M + S tires is installed.

Tightening torque: 110 Nm (80 lb-ft).
For tire specifications, refer to "Technical Data".

Note:

The use of retread tires is not recommended. Retread tires may adversely affect the handling characteristics and safety of the vehicle.

Rotating wheels:

The wheels can be rotated according to the degree of tire wear while retaining the same direction of travel. Rotating, however, should be carried out before the characteristic tire wear pattern (shoulder wear on front wheels and tread center wear on rear wheels) becomes visible at a mileage of 5000 – 10 000 km (3000 – 6000 miles) as otherwise the driving properties deteriorate.

Underinflated tires due to a slow leak (e.g. due to a nail in the tire) may cause damage such as tread separation, bulging, etc. Regular tire pressure checks (including the spare tire) at intervals of no more than 14 days are therefore essential. Keep in mind

that warm tires have a higher pressure than cold tires. (See tire pressure chart on fuel filler door and the last page.) If a tire constantly loses air, it should be inspected for damage.

Use only genuine MERCEDES-BENZ wheel bolts (identified by Mercedes star).

Thoroughly clean the inner side of the wheels any time you rotate the wheels or wash vehicle underside.

Dented or bent rims cause tire pressure loss and damage to the tire beads. For this reason, check rims for damage at regular intervals.

The rim flanges must be checked for wear before a tire is mounted. Remove burrs, if there are any.

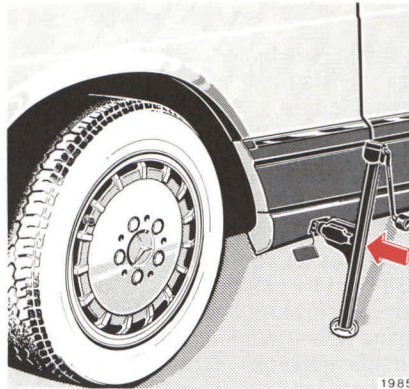
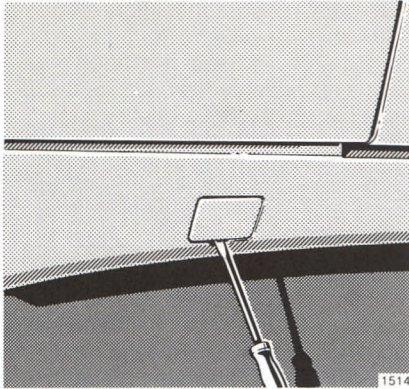

Warning!

The jack is designed exclusively for jacking up the vehicle at the jack tubes built into either side of the vehicle. Use the jack only to lift the vehicle during a wheel change. Never get beneath the vehicle while it is supported only by the jack. Keep hands and feet away from the area under the lifted tire. Jack stands must be used when working under the vehicle. Always set parking brake and block wheels before raising vehicle with jack.

Changing Wheels

1. Move vehicle a safe distance off the roadway.
2. Set parking brake and turn on hazard warning flasher.
3. Move selector lever to position "P".
4. Prevent vehicle from rolling away by blocking wheels with wheel chocks or sizeable wood block or stone (not supplied with vehicle): When changing a wheel on a hill, place chocks on the downhill side of each wheel of the other axle; on a level road, place one chock in front of and one behind the wheel that is diagonally opposite to the wheel being changed.

5. Using the combination wrench, loosen but do not yet remove the wheel bolts.
6. Remove cap from the jack support tube. (The tube openings are located directly behind the front wheel housings and in front of the rear wheel housings.)
7. Insert jack arm fully into the tube hole up to the stop.
8. Position the jack so that it will always be vertical (plumb-line) as seen from the side (see arrow), even on inclines. Jack up the vehicle until the wheel is clear off the ground.

9. Then unscrew wheel bolts completely. Keep bolt threads protected from dirt and sand. While removing last bolt, hold wheel against hub to avoid paint damage on rim.
10. Remove wheel.

11. Screw the alignment bolt (supplied in tool kit) into an upper threaded hole.
12. Adjust the jack height so that the wheel can be slipped on without being lifted.
13. Install spare wheel on wheel hub. Insert wheel bolts and tighten them slightly.
To avoid paint damage, place wheel flat against hub and hold it there while installing first wheel bolt. Unscrew the alignment stud to install the last wheel bolt.
14. Lower car, remove jack.
15. Engage jack tube cover hooks on top and snap bottom into place.
16. Tighten the five bolts evenly, always skipping one, until all bolts are tight. Observe a tightening torque of 110 Nm (80 lb-ft).
17. Correct tire pressure.

Important!

Retighten wheel mounting bolts after approx. 800 km (500 miles). Observe a tightening torque of 110 Nm (80 lb-ft).

Tire Inflation Pressure

A table (see fuel filler flap or last page) lists the tire inflation pressures specified for summer and winter tires as well as for the varying operating conditions.

Important!

Tire pressure differs by approx. 0.1 bar (1.5 psi) per 10 °C (18 °F) of air temperature change. Keep this in mind when checking tire pressure inside a garage – especially in the winter.

Example:

If garage temperature = approx. +20 °C (+68 °F) and, ambient temperature = approx. 0 °C (+32 °F) then the adjusted air pressure = specified air pressure +0.2 bar (+3 psi).

Tire pressures listed for light loads are minimum values offering high driving comfort. Increased inflation pressures for heavy loads produce favorable handling characteristics with lighter loads and are perfectly permissible. The ride of the vehicle, however, will become somewhat harder.

Tire temperature and pressure increase with the vehicle speed. Tire pressure should therefore only be corrected on cold tires. Correct tire pressure in warm tires only if pressure has dropped below the pressure listed in the table and the respective operating conditions are taken into consideration.

Battery

Check electrolyte level in each cell approximately every three months, and more frequently during the summer and in hot climates.

Refill battery with distilled or tap water. Do not use metal funnels or push through the overfill-protection diaphragms in the filler holes.

The battery is completely filled when the water stops draining through the overfill-protection diaphragm.

To check the battery charge with a hydrometer, push its tip through the overfill-protection diaphragm and take an electrolyte sample.

Coat battery terminal clamps with acid-proof grease. Keep battery clean and dry.

The service life of the battery is also dependent on its condition of charge. It must always be sufficiently charged for the battery to last an optimum length of time.

Therefore, we recommend that you have the battery charge checked frequently if you use the vehicle mostly for short distance trips, or if it is not used for long periods of time.

Only charge a battery with a battery charger after it has been disconnected from the vehicle electrical circuit.

Warning!

Battery fluid contains sulfuric acid. Do not allow this fluid to come in contact with eyes, skin or clothing.

In case it does, immediately flush affected area with water and seek medical help.

A battery will also produce hydrogen gas, which is flammable and explosive. Keep flames or sparks away from battery, avoid improper connection of jumper cables, smoking, etc..

While the engine is running the battery terminal clamps must not be loosened or detached as otherwise the alternator and other electronic units would be damaged.

Only tow vehicle with the battery connected.

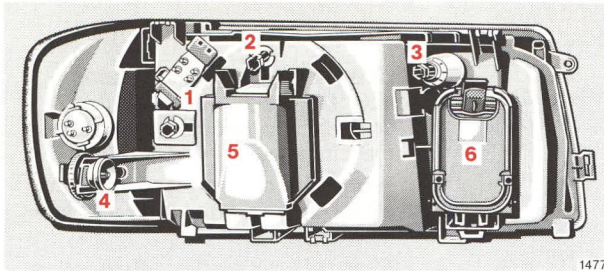

1477

Headlamp Adjustment

Correct headlamp adjustment is extremely important. Check and readjust headlamps at regular intervals and when a bulb has been replaced.

Replacing Bulbs

Install only 12 volt bulbs with the specified watt rating.

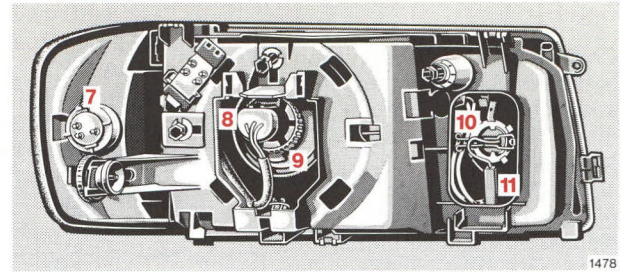

1478

Headlamp Assembly

- | | |
|--|--|
| <ol style="list-style-type: none"> 1 Headlamp horizontal adjustment screw 2 Headlamp vertical adjustment screw 3 Fog lamp adjustment screw 4 Plastic nut for housing of turn signal, parking, side marker and standing lamps 5 High and low beam headlamp cover | <ol style="list-style-type: none"> 6 Fog lamp cover 7 Turn signal, parking, side marker and standing lamp bulb 8 Electrical connector for high and low beam headlamp bulb 9 Clamping ring for high and low beam headlamp bulb 10 Fog lamp bulb 11 Electrical connector for fog lamp bulb |
|--|--|

Replacing bulbs:

Bulb for turn signal, parking, side marker and standing lamp (21/5 W/32/3 cp):

Loosen plastic nut (4) and remove housing towards the front.

Turn bulb socket (7) with bulb counterclockwise and pull out. Push bulb into socket, turn counterclockwise and remove.

Bulb for high and low beam (Halogen type 9004):

Compress cover (5) at the top and remove upwards. Pull off electrical connector (8). Turn clamping ring (9) counterclockwise and pull out bulb together with clamping ring. Remove bulb.

Insert new bulb (flat side facing up), mount clamping ring (9) (with tab facing down) and turn clockwise. Push electrical connector on securely.

Fog lamp bulb (Halogen type H3):

Compress the retaining clip of the cover (6) at the top while removing it upwards. Pull off electrical connector (11). Disengage retaining clip and remove bulb (10). When replacing cover (6), make sure it clicks into place.

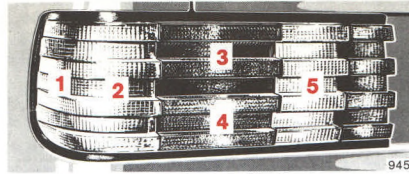

Taillamp Assemblies

- 1 Side marker lamp (10 W/6 cp bulb)
- 2 Turn signal lamp (21 W/32 cp bulb)
- 3 Stop lamp (21 W/32 cp bulb)
- 4 Tail, parking and standing lamp (10 W/6 cp bulb)
- 5 Backup lamp (21 W/32 cp bulb)

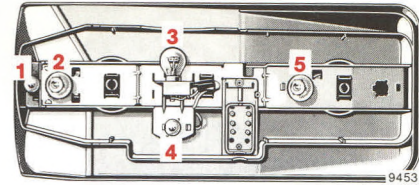

Turn both locks in the trunk to the left as far as the stop and detach bulb carrier. To replace the bulbs, depress, turn to the left and remove.

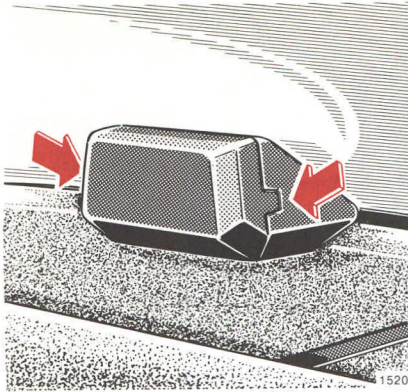

High Mounted Stop Lamp (21 W/32 cp bulb)

To replace the bulb, pull tabs on both sides (arrows) – using a screwdriver – to release cover.

Press bulb down, turn counterclockwise and remove.

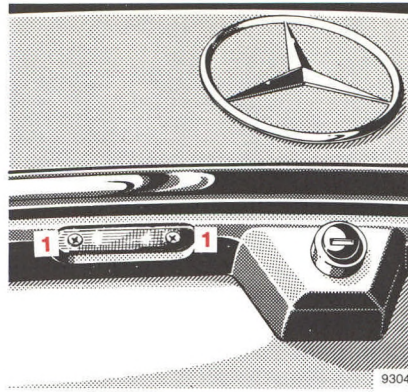

License Plate Lamps (5 W bulb)

Loosen both the securing screws (1), remove lamp and take out bulb.

Spark Plugs

This vehicle is equipped with spark plugs as required for driving in the USA. If additional information is desired, your authorized MERCEDES-BENZ dealer will be happy to offer advice (see also rear inside cover of Owner's Manual).

Remove and install spark plugs (provided with sealing cone) only with combination wrench from the vehicle tool kit or with a recommended spark plug wrench.

Tightening torque 10 – 20 Nm
(7 – 15 lb-ft).

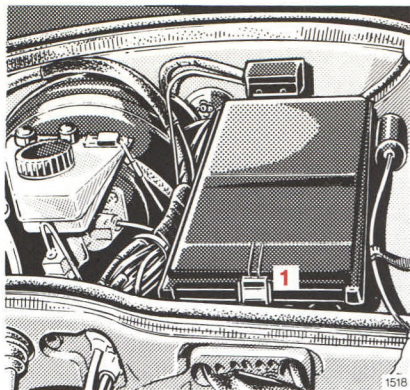

Fuses

The fuse box is located in the engine compartment.

To exchange a fuse, release clamp (1) and remove fuse box cover.

All equipment protected by fuses are listed by number and letter on a label in the lid of the fuse box. The numbers and letters above the fuses correspond to the ones on the label.

Before replacing a blown fuse, determine the cause of the short circuit.

Spare fuses are furnished inside the fuse box. Observe amperage and color of fuse.

Always use a new fuse for replacement. Never attempt to repair or bridge a blown fuse.

After replacing a fuse, replace fuse box cover and secure with clamp (1).

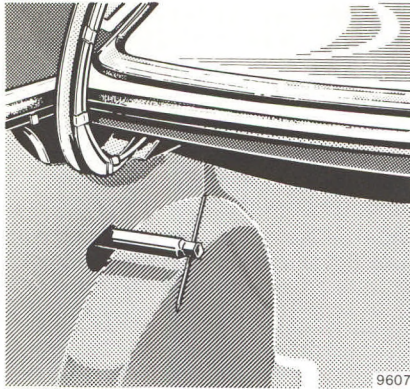

Emergency Operation of Sliding Roof

The sliding roof can be opened or closed manually should an electrical malfunction occur.

Fold back access cover in left side panel of trunk with a screwdriver. Insert socket wrench (from tool kit) through opening in panel and place on the hex-drive of the electric motor. Turn socket wrench (manually) to open or close roof as desired.

To slide the roof closed or to raise the roof at the rear: turn clockwise.

To slide the roof open or to lower the roof at the rear: turn counterclockwise.

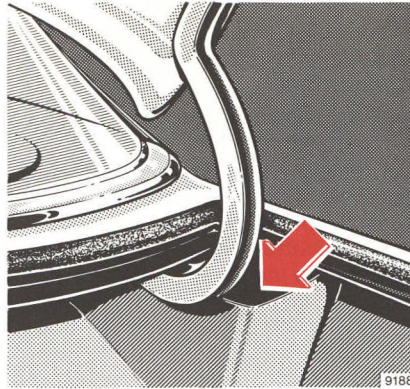

Manual Release of Fuel Filler Flap

If the central locking system does not release the fuel filler flap automatically, pull back the knob on the vacuum element on the right side of the trunk while opening the filler flap.

Windshield Wipers

To release frozen windshield wiper blades or to replace worn blades, the windshield wiper arms can be pulled out of their recess by hand. Sufficient force must be applied to overcome spring resistance. Be careful not to tear rubber blades which are frozen to the glass, as this will reduce the effectiveness of the wipers.

To ensure operation of the windshield wiper even when it is snowing heavily, an overload protection has been installed. It becomes effective if a certain wiping resistance is exceeded as a result of snow accumulation. The windshield wiper arm will then no longer return completely to its initial position, although the windshield wiper motor continues to run a full cycle. If this condition is encountered, the accumulated snow should be manually removed when it is safe.

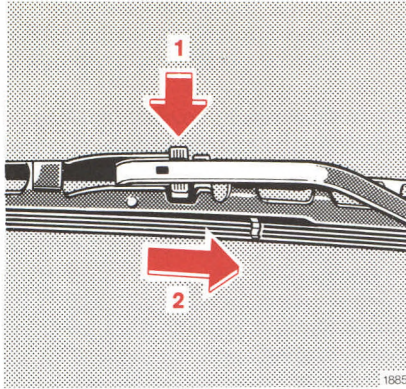

Replacing Wiper Blades

Remove key from steering lock before replacing a wiper blade.

Windshield Wiper Blades

Removal:

Pull the wiper arms from their recess below the hood across the windshield until they stop (just above the hood line).

Change wiper blades one at a time while holding wiper arms to prevent the wiper arms from slipping back into their parked position recess.

Press safety tabs (1) and slide wiper blade towards the wiper arm base (2). Lift wiper arm and remove wiper blade.

Installation:

Lift wiper arm, insert wiper blade in arm and lock in place.

Note:

Do not open engine hood with wiper arm folded forward.

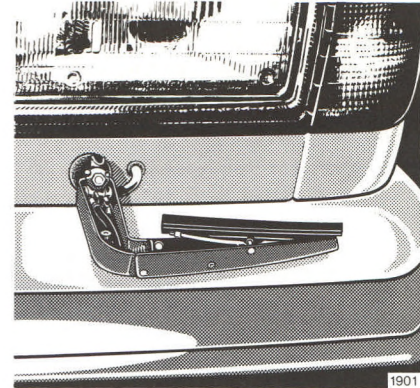

Headlamp Wiper Blades

Removal:

Fold wiper arm forward. Pull wiper blade up to remove.

Installation:

Place wiper blade straight on wiper arm and press onto wiper arm.



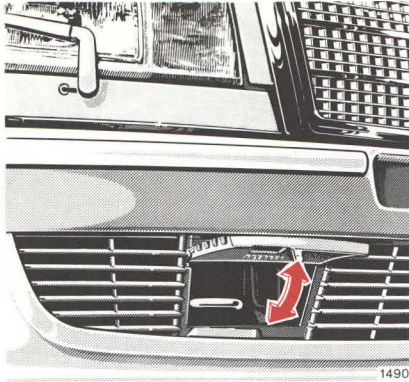

Towing the Vehicle

The front towing eye is located on the passenger side behind a flap in the bumper panel and the rear towing eye on the passenger side below the bumper.

We recommend that the vehicle be transported using flat bed equipment. This method is preferable to other types of towing.

The vehicle may be towed with all wheels on the ground and the selector lever in position "N" for distances up to 120 km (75 miles) and at a speed not to exceed 50 km/h (30 mph).

To positively avoid a possibility of damage to the transmission, however, we recommend to disconnect the drive shaft at the rear axle drive flange on any towing beyond a short tow to a nearby garage.

Do not tow with sling-type equipment.

Towing with sling-type equipment over bumpy roads will damage radiator and supports.

Use wheel lift or flat bed equipment.

Jump Starting

If the battery is discharged the engine can be started with jumper cables and the (12 V) battery of another vehicle. Proceed as follows:

1. Position the vehicle with the charged battery so that the jumper cables will reach, but never let the vehicles touch. Make sure the jumper cables do not have loose or missing insulation.
2. On both vehicles:
 - Turn off engine and all lights and accessories, except hazard flashers or work lights.
 - Apply parking brake and shift selector lever to position "P".
 - Be sure the battery vent caps are tight. Place a damp cloth over the vent caps, making certain it is clear of all moving parts.
3. Clamp one end of the first jumper cable to the positive (+) terminal on the discharged battery and the other end to the positive (+) terminal on the charged battery. Make sure the cable clamps do not touch any other metal parts.
4. Clamp one end of the second jumper cable to the grounded negative (–) terminal of the charged battery and the final connection to a grounded heavy metal bracket in the engine compartment or on the engine of the disabled vehicle. Make sure the cables are not on or near pulleys, fans, or other parts that will move when the engine is started.
5. Start engine of the vehicle with the charged battery and run at high idle. Then start engine of the disabled vehicle in the usual manner.
6. After the engine has started, remove jumper cables by reversing the above installation sequence exactly, starting with the jumper cable connected to a heavy metal bracket in the disabled vehicle's engine compartment. When removing each clamp, make sure that it does not touch any other metal while the other end is still attached.

Important!

A discharged battery can freeze at approx. -10°C ($+14^{\circ}\text{F}$). In that case it must be thawed out before jumper cables are used.

Jumper cable specifications:

- Minimum cable cross-section of 25 mm^2 or approx. 2 AWG
- Maximum length of 3500 mm (11.5 ft).

Warning!

Never lean over batteries while jump starting, you might get burned.

Battery fluid contains sulfuric acid. Do not allow this fluid to come in contact with eyes, skin, or clothing. In case it does, immediately flush affected area with water, and seek medical help.

A battery will also produce hydrogen gas, which is flammable and explosive. Keep flames or sparks away from battery, avoid improper connection of jumper cables, smoking, etc..

Cleaning and Care of the Vehicle

In operation, your vehicle is subjected to varying external influences which, if gone unchecked, can attack the paintwork as well as the underbody and cause lasting damage.

Such damage is caused not only by extreme and varying climatic conditions, but also by air pollution, road salt, tar, gravel and stone chipping. Grease and oil, fuel, coolant, brake fluid, bird droppings, tree resins, etc. should be removed immediately to avoid paint damage. Frequent washing, however, reduces and/or eliminates the aggressiveness and potency of the above adverse influences.

More frequent washings are necessary to deal with unfavorable conditions; for example, near the ocean, in industrial areas (smoke, exhaust emissions), or during winter operation.

You should check your vehicle from time to time for stone chipping or other damage. Any damage should be repaired as soon as possible to prevent the start of corrosion.

In doing so, do not neglect the underside of the car. A prerequisite for a thorough check is a washing of the underbody followed by a thorough inspection. Damaged areas need to be re-undercoated.

Your vehicle has been treated at the factory with a wax-base rustproofing in the body cavities which will last for the lifetime of the vehicle. Post-production treatment is neither necessary nor recommended by MERCEDES-BENZ because of the possibility of incompatibility between materials used in the production process and others applied later.

We have selected car-care products and compiled recommendations which are specially matched to our vehicles and which always reflect the latest technology. You can obtain MB car-care products at your authorized MERCEDES-BENZ dealer.

Scratches, corrosive deposits, corrosion or damage due to negligent or incorrect care cannot always be removed or repaired with the car-care products recommended here. In such cases it is best to seek aid at your authorized MERCEDES-BENZ dealer.

The following topics deal with the cleaning and care of your vehicle and give important "how-to" information as well as references to recommended MB car-care products.

Engine Cleaning

Corrosion protection, such as MB Anti-corrosion Wax, should be applied to the engine compartment after every engine cleaning. Before applying, all control linkage bushings should be lubricated. The poly-V-belt and all pulleys should be protected from any wax.

Car Washing

Before washing your vehicle, remove insect residues. MB Insect Remover is recommended. Do not use hot water or wash your car in direct sunlight. Use only a mild car wash detergent, such as MB Autoshampoo.

Thoroughly spray the car with a diffused jet of water. Direct only a very weak spray towards the ventilation intake. Use plenty of water and rinse the sponge and chamois frequently.

Rinse with clear water and thoroughly wipe dry with a chamois. Do not allow cleaning agents to dry on the finish.

If the vehicle has been run through an automatic car wash – in particular one of the older installations – rewipe the recessed sections in the taillamps (designed to prevent soiling) if necessary. No solvents (fuels, thinners etc.) must be used.

In the winter, thoroughly remove all traces of road salt as soon as possible.

When washing the underbody, do not forget to clean the inner sides of the wheels.

Tar Stains

Quickly remove tar stains before they dry and become more difficult to remove. MB Tar Remover is recommended.

Window Cleaning, Wiper Blades

Use a window cleaning solution on very dirty or oil-stained windows. Clean windshield wiper blades with a clean cloth and detergent solution. Replace blades twice a year; once before and once after winter.

Headlamp Cleaning System

The condition of the wiper blades is important for satisfactory cleaning of the headlamp lenses. We therefore recommend that the blades be inspected regularly.

Replace damaged wiper blades.

Plastic Parts, Headliner and Rubber Parts

Do not use oil or wax on these parts.

Seat Belts

The webbing must not be treated with chemical cleaning agents. Use only clear, lukewarm water and soap. Do not dry the webbing at temperatures above 80 °C (176 °F) or in direct sunlight. Never bleach or re-dye the webbing as this may severely weaken the belts.

Instrument Cluster

Use a gentle dish-washing detergent or mild detergent for delicate fabrics as a washing solution. Wipe with a cloth moistened in lukewarm solution. Do not use scouring agents.

Steering Wheel and Selector Lever

Wipe with a damp cloth and dry thoroughly or clean with MB-Leather Cleaner.

Upholstery

Using aftermarket seat covers or wearing clothing that have the tendency to give off coloring (e.g. when wet, etc.) may cause the upholstery (velour for example) to become permanently discolored. By lining the seats with a proper intermediate cover, contact-discoloration will be prevented.

Leather Upholstery

Wipe leather upholstery with a damp cloth and dry thoroughly or clean with MB Leather Cleaner. Exercise particular care when cleaning perforated leather as its underside should not become wet.

Velour Upholstery

Pressure marks resulting from dampness and heat may appear to be stains. Such marks can be removed by wiping with a moistened brush, ironing with a wet cloth or by treating with a dry shampoo. Do not sit on damp upholstery. Quick drying is achieved by applying hot air – for example, by using a hair dryer. If in doubt, please consult your authorized MERCEDES-BENZ dealer.

Paintwork, Painted Body Components

MB-Paint Protector and Sealer should be applied when water drops on the paint surface do not “bead up”; normally in 3 – 5 months depending on climate and washing detergent used.

MB-Paint-Polish should be applied if paint surface shows signs of dirt embedding (i.e. loss of gloss).

MB-Fine-Polishing Paste must be used when the paint surface shows signs of excessive fading/chalking due to lack of care, etc..

Do not apply any of these products or way if your car is parked in the sun or if the hood is still hot.

Use the appropriate MB Touch-Up Stick for quick and provisional repairs of minor paint damage (i.e. chips from stones, car doors, etc.).

Automatic Antenna

For trouble-free operation of the automatic antenna, we recommend to clean the antenna mast periodically.

Light Alloy Wheels

MB-Autoshampoo should be used for regular cleaning of the light alloy wheels.

If possible, clean wheels once a week with MB-Autoshampoo, using a soft sponge and an ample supply of lukewarm water.

If the MB-Autoshampoo does not satisfactorily clean the wheels, use MB-Protective Agent for Light Alloy Wheels for normal cleaning and MB-Cleaner for Light Alloy Wheels for heavier dirt accumulation.

Follow instructions on container.

Ornamental Moldings

For regular cleaning and care of very dirty chrome-plated parts, use a chrome cleaner.

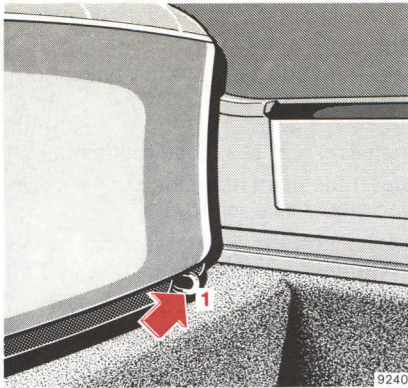

Rear Seat Cushion

Removal: Push buttons (1) (left and right side of seat) down while slightly lifting the front corner of the seat cushion. Then pull the seat cushion forward.

Installation: Push rear of seat cushion under seat back as far as it will go and press down on the front section until it engages.

Note:

On vehicles with power rear seats, the rear seat cushion can best be removed and installed by an authorized MERCEDES-BENZ dealer.

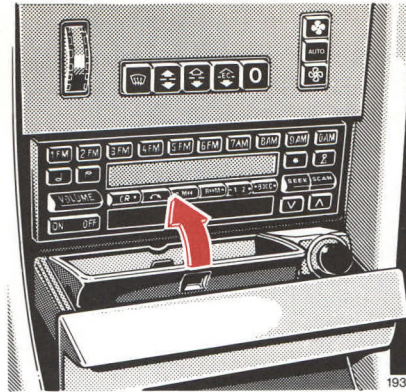

Ashtrays

To remove front ashtray: Pull ashtray out to the stop, lift up insert and remove.

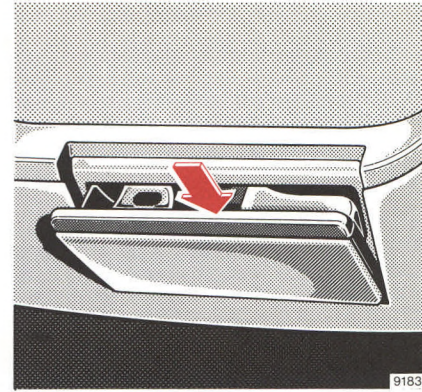

To remove rear ashtray:

Push the ashtray down while opening and remove.

To install ashtray:

Position ashtray squarely and push in.

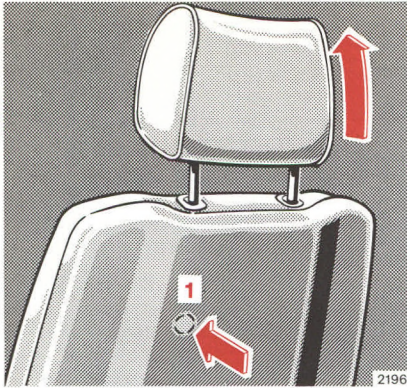

Head Restraints

Removing front seat head restraints:
Bring the head restraint to its highest position.

Depress release button (1) beneath the seatback covering material and pull head restraint up sharply, holding it by the left head restraint post (viewed in driving direction). Then pull out head restraint completely with both hands.

The release button (1) is located below the left head restraint post on both front seats.

Installing front seat head restraints:
Insert the head restraint and push it down to the stop.

Check if the highest position can be reached by pushing the switch up for approximately 5 seconds.

Adjust head restraint to the desired position.

Removing rear seat head restraints:
Pull head restraint up until detent is felt. Then pull it out sharply using both hands.

Installing rear seat head restraints:
Insert the head restraint, push it down and adjust as desired.

Warning!

For your protection, drive only with properly positioned head restraints.

Do not drive the vehicle without the head restraints. Head restraints are intended to help reduce injuries during an accident.

For positioning of head restraints refer to pages 31 and 33.

Luggage or Ski Racks

We recommend the use of drip-rail mounted ski and roof racks. These racks do not require additional supports (suction cups or legs). Such supports may lead to marring of the paint or even denting of the roof if excessive weight is placed on the rack. Your authorized MERCEDES-BENZ dealer can give further advice.

Spare Parts Service

All authorized MERCEDES-BENZ dealers maintain a stock of original spare parts required for maintenance and repair work. In addition, strategically located parts distribution centers provide quick and reliable parts service.

More than 300,000 different spare parts, even for older models, are available.

MERCEDES-BENZ original spare parts are subjected to the most stringent quality inspections. Each part has been specifically developed, manufactured or selected for and adapted to MERCEDES-BENZ vehicles.

Therefore, MERCEDES-BENZ original spare parts should be installed.

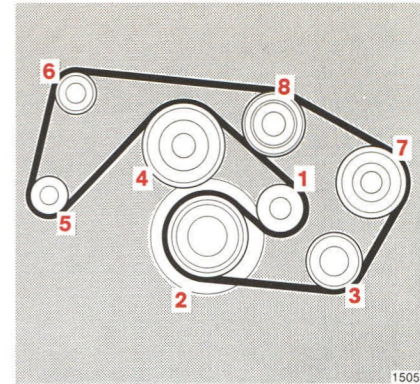

Layout of Poly-V-belt Drive

- 1 Automatic belt tensioner
- 2 Crankshaft
- 3 Air conditioning compressor
- 4 Fan
- 5 Alternator
- 6 Idler pulley
- 7 Power steering pump
- 8 Coolant pump

Install the poly-V-belt by starting at the belt tensioner (1) and proceed with the other pulleys in numerical order.

For dimensions of the poly-V-belt, see page 99.

Technical Data Fuels, Coolants, Lubricants, etc. Consumer Information

Identification Plates	96
Theft Prevention	97
Vehicle Data Cards	98
Warranty Coverage	98
Technical Data	99
Fuels, Coolants, Lubricants, etc.	100
Capacities	100
Engine Oils	102
Brake Fluid	102
Premium Unleaded Gasoline	102
Fuel Requirements	102
Coolants	103
Consumer Information	104



Identification Plates

When ordering spare parts, please specify vehicle identification and engine numbers.

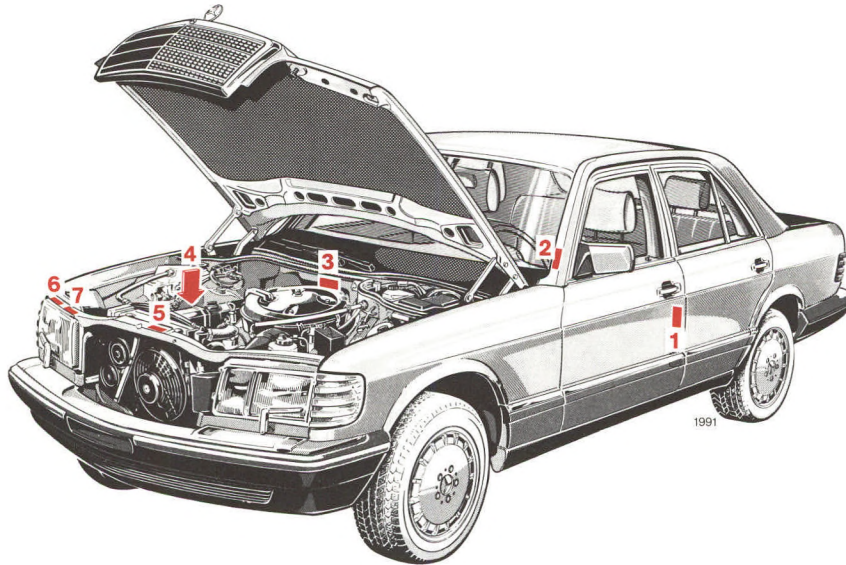

- 1 Certification Tag
(left door pillar)
- 2 Identification Tag
(left window post)
- 3 Vehicle Identification No.
- 4 Engine No.
- 5 Body No. and Paintwork No.
- 6 Emission Control Tag
- 7 Information Tag
California version
Vacuum line routing
for emission control system

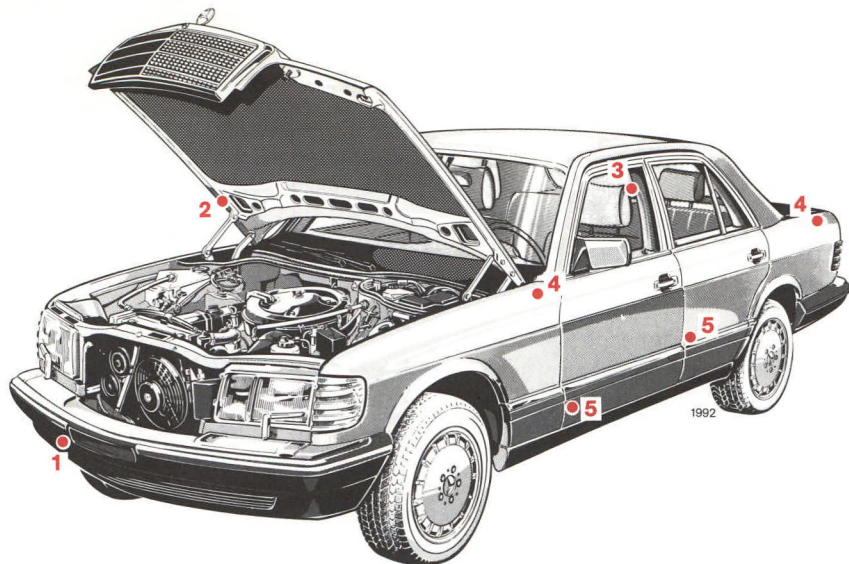

Location of labels

- 1 Bumper front/rear
- 2 Engine hood
- 3 Trunk lid
- 4 All fenders
- 5 All doors

Engine*:

on engine block, rear

Transmission*:

on transmission, left front

* not shown in illustration

Theft Prevention

This vehicle complies with the Federal Motor Vehicle Theft Prevention Standard (49 CFR Part 541). Engine, transmission and certain body parts (see illustration) are labeled at the factory, the labels show the VIN-number of this vehicle.

Spare parts are similarly labeled at the factory in a different location. The labels show the letter R (for replacement) instead of the VIN-number.

Note:

Do not remove these labels. These labels are intended for parts identification in case of theft. When replacing parts subject to labeling, please make sure that the parts you receive are labeled properly. This is especially important when work is performed outside of the United States.

Vehicle Data Cards

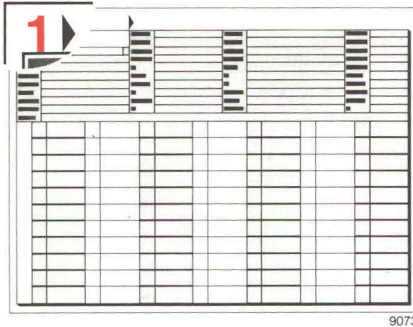

The vehicle data cards bear all the important data relating to your vehicle. Data card No. 1 bears the key number and should never be left in the vehicle. Submit this card to your authorized MERCEDES-BENZ dealer to request a replacement key in case of loss. Data card No. 2 has no key number information and should be kept in the Maintenance Booklet where indicated.

Warranty Coverage

Your car is covered under the terms of the "warranties" printed in the Owner's Service and Warranty Policy Booklet and your authorized MERCEDES-BENZ dealer will exchange or repair any defective parts in accordance with the terms of the following warranties:

1. New vehicle limited warranty
2. Emission system warranty
3. Emission performance warranty
4. California emission control systems warranty (State of California only unless purchased optionally for diesel models).

Loss of Owner's Service and Warranty Policy

Should you lose your Owner's Service and Warranty Policy Booklet, have your authorized MERCEDES-BENZ dealer arrange for a replacement. It will be mailed to you.

Technical Data

Model	300 SE (126 024) ¹ 300 SEL (126 025) ¹
-------	---

Engine

Engine type	103
Mode of operation	4-stroke engine, gasoline injection
No. of cylinders	6
Bore	88.50 mm (3.48 in)
Stroke	80.25 mm (3.16 in)
Total piston displacement	2962 cm ³ (180.8 in ³)
Compression ratio	9.2
Output acc. to SAE J 1349	132 kW/5700 rpm (177 hp/5700 rpm)
Maximum torque acc. to SAE J 1349	255 Nm/4400 rpm (188 ft-lb/4400 rpm)
Firing order	1 – 5 – 3 – 6 – 2 – 4
Poly-V-belt (single drive belt)	2255 mm

Rims-Tires

Rims (forged light alloy rims)	6½ J × 15 H 2
Wheel offset	21.5 mm (0.8 in)
Summer tires:	
Radial-ply tires	205/65 R 15 94 H
Winter tires:	
Radial-ply tires	205/65 R 15 94 T M + S

Electrical System

Alternator	14 V/80 A
Starter motor	12 V/1.7 kW
Battery	12 V/62 Ah
Spark plugs	see rear inside cover

Weights

	See certification tag
Roof load max.	100 kg (220 lb)
Trunk load max.	100 kg (220 lb)

Main Dimensions 300 SE

Overall vehicle length	5145 mm (202.6 in)
Overall vehicle width	1820 mm (71.7 in)
Overall height	1437 mm (56.6 in)
Wheel base	2935 mm (115.6 in)
Track, front	1562 mm (61.5 in)
Track, rear	1534 mm (60.4 in)

Main Dimensions 300 SEL

Overall vehicle length	5285 mm (208.1 in)
Overall vehicle width	1820 mm (71.7 in)
Overall height	1441 mm (56.7 in)
Wheel base	3075 mm (121.1 in)
Track, front	1562 mm (61.5 in)
Track, rear	1534 mm (60.4 in)

¹ The quoted data apply only to the standard vehicle. See an authorized MERCEDES-BENZ dealer for the corresponding data of all special bodies and special equipment.

Fuels, Coolants, Lubricants, etc. Capacities

Vehicle components and their respective lubricants must match. Therefore use only brands tested and recommended by us. Inquire at your authorized MERCEDES-BENZ dealer.

	Capacity	Fuels, coolants, lubricants, etc.
Engine with oil filter	6.0 l (6.3 US qt)	<p>Recommended engine oils</p> <p>Ambient temp. SAE grades</p> <p>°F °C</p> <p>+86 +30 +68 +20 +50 +10 +32 0 +23 -5 +14 -10 +5 -15 -4 -20</p> <p>5W-20 5W-30 10W-30 10W-40 10W-50 15W-40 15W-50 20W-40 20W-50 30¹</p> <p>Year-round use multigrade oil</p> <p>8938</p> <p>¹ SAE 40 may be used if ambient temperatures constantly exceed +30 °C (+86 °F).</p>
Automatic transmission	Initial fill: 7.3 l (7.7 US qt) Fluid change: 6.2 l (6.6 US qt)	MB Automatic transmission fluid

	Capacity	Fuels, coolants, lubricants, etc.
Rear axle	1.1 l (1.2 US qt)	Hypoid gear oil SAE 90, 85 W 90 ¹
Accelerator control linkage		Hydraulic fluid ¹
Power steering	1.3 l (1.4 US qt)	MB Power steering fluid
Front wheel hubs	approx. 60 g (2.1 oz) each	High temperature roller bearing grease
Grease nipples		Multipurpose or lubrication grease
Door locks		Powdered graphite
Battery terminals		Bosch special grease (acid proof)
Brake reservoir	approximately 0.5 l (0.5 US qt)	MB Brake fluid (DOT4)
Windshield washer system and headlamp cleaning system	approximately 5.0 l (5.3 US qt)	MB Windshield washer concentrate "S" ²
Fuel tank including a reserve of	approximately 90 l (23.8 US gal) approximately 12.5 l (3.3 US gal)	Premium unleaded gasoline: Posted Octane 91 (Average of 96 RON/86 MON)
Cooling system	approximately 10.0 l (10.6 US qt)	MB Anticorrosion/antifreeze

¹ Your authorized MERCEDES-BENZ dealer will advise you on recommended brands.

² Use MB Windshield Washer Concentrate "S" and water for temperatures above freezing or MB Windshield Washer Concentrate "S" and commercially available premixed windshield washer solvent/anti-freeze for temperatures below freezing. Follow suggested mixing ratios, see page 45.

Engine Oils

Engine oils are specifically tested for their suitability in our engines. Therefore, use only engine oils recommended by MERCEDES-BENZ. Information on recommended brands is available at your authorized MERCEDES-BENZ dealer.

Brake Fluid

During vehicle operation, the boiling point of the brake fluid is continuously reduced through the absorption of moisture from the atmosphere. Under extremely hard operating conditions, this moisture content can lead to the formation of bubbles in the system thus reducing the system's efficiency.

The brake fluid must therefore be replaced annually, preferably in the spring.

It is recommended to use only brake fluid approved by MERCEDES-BENZ. Your authorized MERCEDES-BENZ dealer will provide you with additional information.

Premium Unleaded Gasoline

Caution!

To maintain the engines durability and performance, premium unleaded gasoline must be used. If premium unleaded is not available and low octane fuel is used, follow these precautions:

- have the fuel tank filled only partially with unleaded regular and fill up with premium unleaded as soon as possible,
- avoid full throttle driving and abrupt acceleration,
- do not exceed an engine speed of 3000 rpm, if the vehicle is loaded with a light load such as two persons and no luggage,
- do not exceed $\frac{2}{3}$ of maximum accelerator pedal position, if the vehicle is fully loaded or operating in mountainous terrain.

Fuel Requirements

Use only Premium unleaded meeting ASTM standard D 439:

The octane number (posted at the pump) must be 91 min. It is an average of both, the Research (R) octane number and the Motor (M) octane number: $[(R + M)/2]$. This is also known as ANTI-KNOCK INDEX.

Unleaded gasoline containing oxygenates such as Ethanol, MTBE, IPA, IBA and TBA can be used provided the ratio of any one of these oxygenates to gasoline does not exceed 10%.

The ratio of Methanol to gasoline must not exceed 3% plus additional cosolvents.

Using mixtures of Ethanol and Methanol is not allowed. MTBE may, however, be added up to 15%. Gasohol, which contains 10% Ethanol and 90% unleaded gasoline, can be used.

These blends must also meet all other fuel requirements such as resistance to spark knock, boiling range, vapor pressure, etc..

Coolants

The engine coolant is a mixture of water and anticorrosion/antifreeze, which provides:

- corrosion protection
- freeze protection
- boiling protection (by increasing the boiling point).

The cooling system was filled at the factory with a coolant providing freeze protection to approx. -30°C (-22°F) and corrosion protection. The red area of the temperature gauge is matched to the heating properties of this coolant solution.

The coolant solution must be used year round to provide the necessary corrosion protection and increase in the boil-over protection. You should have it replaced every 3 years.

To provide the important corrosion protection, the solution must be at least 40 % anticorrosion/antifreeze (equals a freeze protection to approx. -25°C [-13°F]). If you use a solution that is more than 55 % anticorrosion/antifreeze (freeze protection to

approx. -45°C [-49°F]), the engine temperature will increase due to the lower heat transfer capability of the solution. Therefore, do not use more than this amount of anticorrosion/antifreeze.

If the coolant level is low, water and MB anticorrosion/antifreeze should be used to bring it up to the proper level (have cooling system checked for signs of leakage).

The water in the cooling system must meet minimum requirements, which are usually satisfied by normal drinking water. If you are not sure about the water quality, consult your authorized MERCEDES-BENZ dealer.

Anticorrosion/antifreeze

Your vehicle contains a number of aluminium parts. The use of aluminium components in motor vehicle engines necessitates that anticorrosion/antifreeze coolant used in such engines be specifically formulated to protect the aluminium parts.

(Failure to use such anticorrosion/antifreeze coolant will result in a significantly shortened service life.)

Therefore the following product is strongly recommended for use in your car: MERCEDES-BENZ Anticorrosion/Antifreeze Agent.

Before the start of the winter season (or once a year in the hot southern regions), you should have the anticorrosion/antifreeze concentration checked. The coolant is also regularly checked each time you bring your vehicle to your authorized MERCEDES-BENZ dealer for maintenance service.

Approx. freeze protection	Anticorrosion/antifreeze
-30°C (-22°F)	4.50 l (4.8 US qt)
-45°C (-49°F)	5.50 l (5.8 US qt)

Consumer Information

This has been prepared as required of all manufacturers of passenger cars under Title 49, Code of U.S. Federal Regulations, Part 575 pursuant to the “National Traffic and Motor Vehicle Safety Act of 1966”.

Uniform Tire Quality Grading

Relevant tire grade information on tire sidewalls.

All passenger car tires must conform to federal safety requirements. In addition, consumer information on treadwear, traction and temperature must be provided.

Treadwear

The treadwear grade is a comparative rating based on the wear rate of the tire when tested under controlled conditions on a specified government test course. For example, a tire graded 150 would wear one and a half (1½) times as well on the government course as a tire graded 100. The relative performance of tires depends upon the actual conditions of their use, however, and may depart significantly from the norm due to variations in driving habits, service practices and differences in road characteristics and climate.

Traction “A”, “B”, “C”

The traction grades, from highest to lowest, are “A”, “B” and “C” and they represent the tire’s ability to stop on wet pavement as measured under controlled conditions on specified government test surfaces of asphalt and concrete. A tire marked “C” may have poor traction performance.

Warning!

The traction grade assigned to this tire is based on braking (straight ahead) traction tests and does not include cornering (turning) traction.

Temperature “A”, “B”, “C”

The temperature grades of “A” (the highest), “B” and “C” representing the tire’s resistance to the generation of heat and its ability to dissipate heat when tested under controlled conditions on a specified indoor laboratory test wheel. Sustained high temperature can cause the material of the tire to degenerate and reduce tire life, and excessive temperature can lead to sudden tire failure. The grade “C” corresponds to a level of performance which all passenger car tires must meet under the Federal Motor Vehicle Safety Standard No. 109. Grades “B” and “A” represent higher levels of performance in the laboratory test than the minimum required by law.

Warning!

The temperature grade for this tire is established for a tire that is properly inflated and not overloaded. Excessive speed, under-inflation, or excessive loading, either separately or in combination, can cause excessive heat build up and possible tire failure.



Airbags 39, 40
Alarm system 30
Alloy wheels 90
Antenna 58, 90
Anticorrosion/antifreeze 103
Arm rests 33
Ashtrays 91
Automatic climate control 22
Automatic transmission 60

Battery 79
Body no. 96
Brake fluid 102
Brake pad wear indicator
 lamp 66
Brake, parking 60
Brakes 16
Brakes, ABS 66
Brake warning lamp 66
Break-in period 8

Capacities 100
Catalytic converter 14
Central locking system 29
Certification tag 96
Charge indicator lamp 64
Cleaning and care of the vehicle 88
Combination switch 45
Console storage
 compartment 49
Consumer information 104
Coolant level check 71
Coolants 101, 103
Coolant temperature
 gauge 64
Cruise control 63

Doors 28
Driver checks 112
Driving instructions 16

Economical driving indicator
 (ECONOMY) 68
Emergency tensioning
 retractors (ETR) 38
Emission control 67
Emission control tag 96
Engine no. 96
Engine oil and filter
 change 19
Engine oil consumption 64
Engine oil level check 72
Engine oils 102
Engine starting and turning off 15
Exterior lamp switch 44
Exterior light failure
 indicator lamp 65

First aid kit 74
Fog lamps 80
Fuel filler flap 84
Fuel requirements 102
Fuel reserve warning lamp 65
Fuels, coolants, lubricants, etc. 100
Fuses 83

Gauges 12, 64
 Coolant temperature 64
 Fuel 12
 Oil pressure 64

Headlamps 44, 80
Headlamp washer 45
Head restraints 31, 33, 92
 front 31, 92
 rear 33, 92
Heated seats 34
Hood 70

Identification plates 96
Indicator lamps 13, 64, 65, 66
 Brake pad wear 66
 Brake warning 66
 Charging system 64
 Check engine 13
 Exterior light failure 65
 Fuel reserve 65
 Low coolant 64
 Low engine oil 64
 Low washer fluid 65
 Symbols 13

Instruments and controls 10
Instrument cluster 12

Jack 75
Jump starting 87

Keys 27

Lamps, exterior 44, 80, 81, 82
 Fog lamps 80
 Headlamps 80
 High mounted stop lamp 82
 License plate lamps 82
 Switch 44
 Taillamps 81

Lamps, interior 48
Lighter 48
Literature 109
Lubricants 100
Luggage or ski racks 93

Maintenance 4, 19

Oil pressure gauge 64
On-board diagnostic system
 (California models only) 67
Orthopedic seat 32
Outside temperature indicator 65

Paintwork no. 96
Parking 18
Parking brake 60
Premium unleaded gasoline 102

Radio 51
Rear view mirrors 46
Rear window defroster 49
Restraint systems,
 infants and children 42
Roadside assistance 4

- Seat belts 36
 - Warning system 36
- Seats 30, 31, 35, 91
 - front 30, 31
 - rear 35, 91
- Service literature 109
- Shelf below rear window 50
- Sliding roof 47
 - Emergency operation 84
- Spare parts 93
- Spare wheel 74
- Spark plugs 82
- Starting and turning off engine 15
- Steering column, adjusting 32
- Steering lock 43
- Stowing things 74
- Sun visors 47
- Supplemental restraint system (SRS) 36, 38

- Technical data 99
- Theft prevention 97
- Tire chains 68
- Tire pressure 78
- Tires 17, 75, 104
- Towing 86
- Transmission, fluid
 - level check 73
- Traveling abroad 68
- Turn signals 45

- Upholstery, cleaning 90
- Vanity mirrors 47
- V-belt 93, 99
- Vehicle data cards 98
- Vehicle identification no. 96
- Vehicle tools 74
- Warranty 4, 98
- Wheels 75
- Wheels, changing 77
- Windows 50
- Windshield/headlamp washer system 45
- Windshield wipers 84
- Winter driving 18, 68
- Wiper blades 85, 89
 - Replacing 85

Service Literature

Your authorized MERCEDES-BENZ dealer has trained technicians and original MERCEDES-BENZ parts to service your vehicle properly. For expert advice and quality service, see your authorized MERCEDES-BENZ dealer.

Customers who are interested in ordering service literature for their vehicles are advised to contact MERCEDES-BENZ distributors in the U.S. or Canada at the following addresses, respectively

for U.S.A.: Mercedes-Benz of North America Inc.
One Mercedes Drive
P.O. Box 350
Montvale, New Jersey 07645
Att: Technical Publications
Tel: (201) 573-0600

for Canada: Mercedes-Benz Canada Inc.
849 Eglinton Ave., East
Toronto, Ont., Canada
M4G 2L5
Att: Technical Publications
Tel: 416-425-3550
Telex: 065-24232

The above companies will be happy to handle any such requests from customers.

We consider this to be the best way to obtain accurate information for your vehicle.

Warning!

To help avoid personal injury, be extremely careful when performing any maintenance work or repairs. Improper or incomplete service may damage the vehicle or its equipment, which may in turn result in personal injury.

If you have any question about carrying out some service, turn to the advice of an authorized MERCEDES-BENZ dealer.

Check Regularly and Before a Long Trip

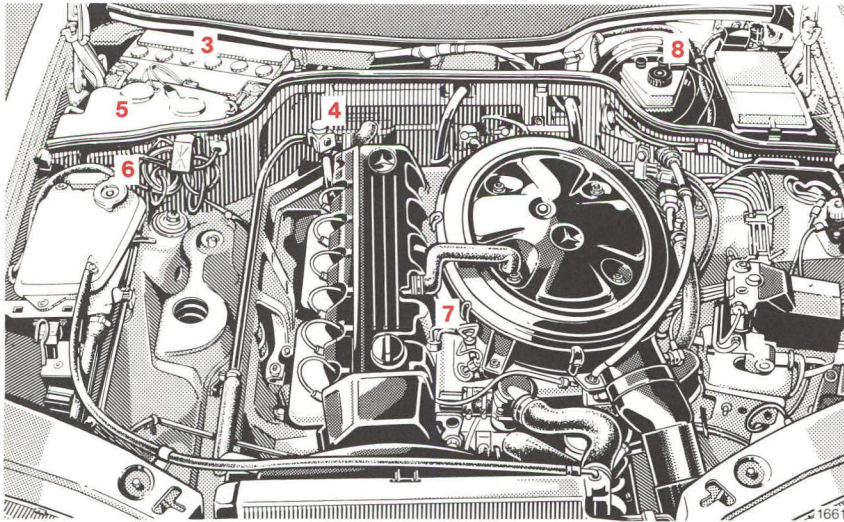
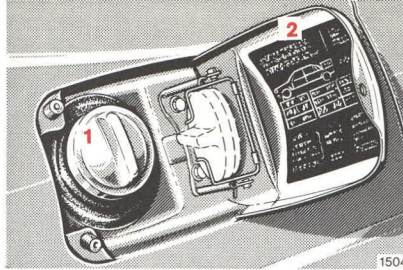
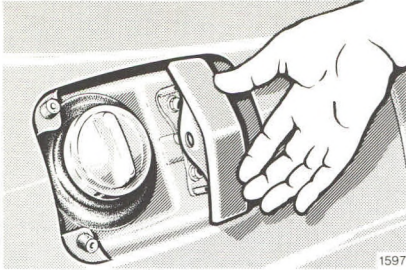

1 Fuel Supply: Turn fuel filler cap to the left and hold on to it until possible pressure in tank has been released, then remove the cap.

2 Tire Inflation Pressure: Check at least every two weeks. For details see page 78.

3 Battery: Add distilled or tap water only, see page 79.

4 Fluid Level in Automatic Transmission: See page 73.

5 Windshield Washer System and Headlamp Cleaning System: See page 101.

6 Coolant Level: See page 71.

7 Engine Oil Level: See page 72.

8 Brake Fluid: See pages 101 and 102.

Vehicle Lighting: Check function and cleanliness. For replacement of light bulbs, see pages 80, 81 and 82.

What You Should Know at the Gas Station

- **Fuel:** Use premium unleaded gasoline:
Posted Octane 91 (Average of 96 RON/86 MON).
Fuel tank capacity approx. 90 l (23.8 US gal), this includes approx. 12.5 l (3.3 US gal) reserve.
Only fill fuel tank until the filler nozzle unit cuts out — do not overfill.
- **Engine Oil:** Engine oil level check, see page 72.
Quantity differential between upper and lower dipstick marking level: 2.0 l (2.1 US qt).
Year-round multigrade oils 10 W-40, 10 W-50, 15 W-40, 15 W-50.
For further information, refer to page 100.
- **Automatic Transmission:** MB Automatic transmission fluid.
For level checks and replenishment, refer to page 73.

- **Coolant:** For normal replenishment, use water (potable water quality).
For further information (e.g. anticorrosion/anti-freeze), refer to page 103.
- **Bulbs:** High and low beams: Halogen type 9004, fog lamps: Halogen type H 3, tail, parking and standing lamps 10 W/6 cp, turn signal, standing, side marker and parking lamps, front 21/5 W/32/3 cp, turn signal lamps, rear 21 W/32 cp, stop lamps 21 W/32 cp, license plate lamps 5 W.
- **Spark Plugs:** Bosch H 9 DC, H 9 DCO, H 9 DP, Beru 14 K-9 DU, 14 K-9 DUO, 14 K-9 DPU, Champion S 12 YC, S 12 YCC.
Electrode gap 0.8 mm (0.032 in).

- **Tire Pressure:**
For driving up to 160 km/h (100 mph)

Cold tires:

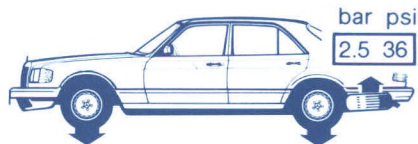

Warm tires:

Pressure may rise by up to +0.5 bar (+7 psi).

Never release any air from a warm tire to offset this pressure increase!

Summer tires	normal load
	maximum load
Winter tires	

bar	psi
1.8 ¹	26 ¹
1.9 ¹	27 ¹
2.3 ¹	33 ¹

bar	psi
1.8 ¹	26 ¹
2.4 ¹	34 ¹
2.6 ¹	38 ¹

¹ For driving above 160 km/h (100 mph) where permitted, add 0.6 bar (9 psi).

DAIMLER-BENZ AG
Stuttgart-Untertuerkheim
Zentralkundendienst



Mercedes-Benz
service

126 584 74 97

Order No. 6550 5792 13

USA-Ausgabe B

1989

