



2385845212

Order no. P238 0938 13 Part no. 238 584 52 12
Edition B-2023



E-Class

Mercedes-AMG Supplement

Mercedes-Benz



Publication details

Internet

Further information about Mercedes-Benz vehicles and about Mercedes-Benz AG can be found on the following websites:

<https://www.mbusa.com> (USA only)

<https://www.mercedes-benz.ca> (Canada only)

Documentation team

©Mercedes-Benz AG: Not to be reprinted, translated or otherwise reproduced, in whole or in part, without written permission from Mercedes-Benz AG.

Vehicle manufacturer

Mercedes-Benz AG

Mercedesstraße 120

70372 Stuttgart

Germany

As at 17.02.22

Thank you for purchasing a Mercedes-AMG

Before your first drive, please read this Operator's Manual carefully and familiarize yourself with your vehicle. For your own safety and a longer service life of the vehicle, follow the instructions and warning notices in this Operator's Manual. Disregarding them may lead to damage to the vehicle or injury to people.

Damage to the vehicle resulting from the disregard of the instructions is not covered by the Mercedes-Benz Limited warranty.

The standard equipment and product description of your vehicle may vary and depends on the following factors:

- Model
- Order
- National version
- Availability

Your vehicle may therefore differ from that shown in the descriptions and illustrations in individual cases.

Mercedes-AMG reserves the right to introduce changes in the following areas:

- Design
- Equipment
- Technical features

The following documents are integral parts of the vehicle:

- Digital operator's manual
- Printed Operator's Manual
- Maintenance Booklet
- Supplementary manuals relating to specific equipment
- Supplementary documents

Keep these documents in the vehicle at all times. Ensure that all documents are in the vehicle or passed on in the event of sale or rental.

Mercedes-Benz USA, LLC

Mercedes-Benz Canada, Inc.

A Mercedes-Benz Group AG Company

2385845212



Symbols	3	Operating the on-board computer	20	Index	41
At a glance	4	Calling up displays on the Performance menu	22		
Cockpit	4	Function of the head-up display	24		
General notes	6	MBUX multimedia system	26		
Operator's Manual	6	AMG TRACK PACE	26		
Occupant safety	7	Maintenance and care	32		
Seat belts	7	Notes on the care of tailpipes	32		
Driving and parking	8	Wheels and tires	33		
Driving	8	Changing a wheel	33		
DYNAMIC SELECT switch	9	Technical data	34		
Automatic transmission	10	Operating fluids	34		
Driving and driving safety systems	12	Vehicle data	35		
Instrument display and on-board com- puter	20	Display messages and warning/indicator lamps	37		
Notes on the instrument display and on- board computer	20	Display messages	37		
		Warning and indicator lamps	38		

In this Operator's Manual, you will find the following symbols:

⚠ WARNING Danger due to failure to observe the warning notices

Warning notices draw your attention to hazards that may endanger your health or life, or the health or life of others.

▶ Observe the warning notices.

🌿 ENVIRONMENTAL NOTE Environmental damage due to failure to observe environmental notes

Environmental notes include information on environmentally responsible behavior or environmentally responsible disposal.

▶ Observe environmental notes.

! NOTE Damage to property due to failure to observe notes on material damage

Notes on material damage inform you of risks which may lead to your vehicle being damaged.

▶ Observe notes on material damage.

i These symbols indicate useful instructions or further information that could be helpful to you.

▶ Instruction

(→ page) Further information on a topic

Display Display field in the Instrument Display/media display



↪ Highest menu level, which is to be selected in the multimedia system

➡➡ Relevant submenus, which are to be selected in the multimedia system

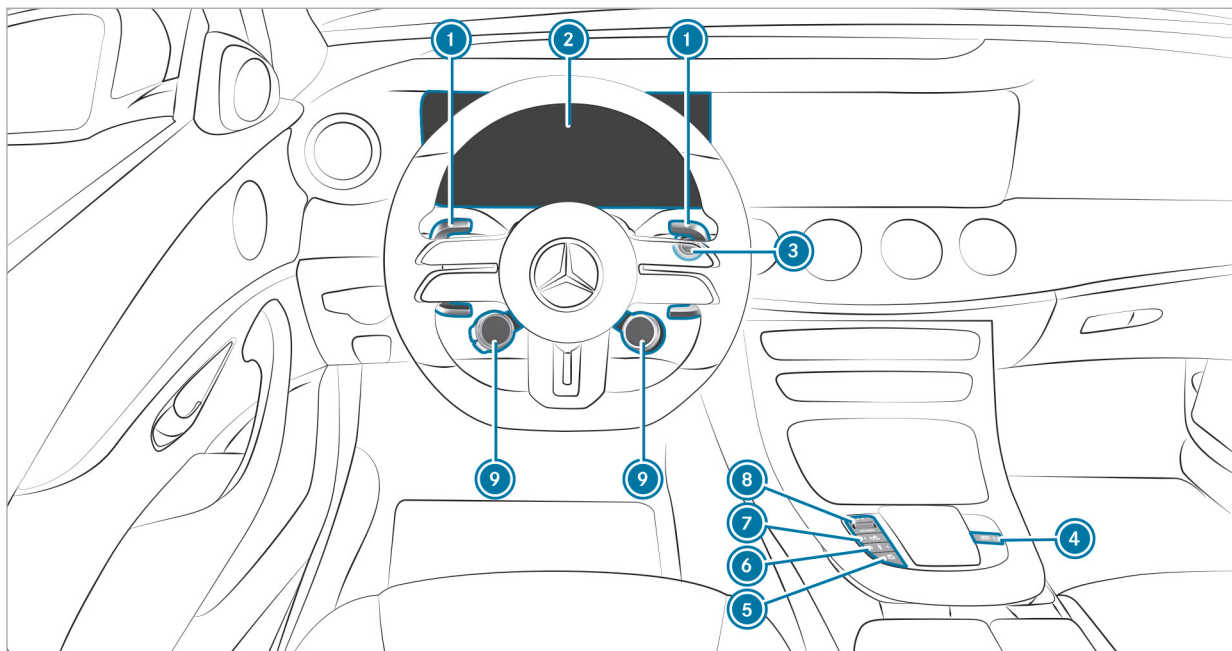
* Indicates a cause



Left-hand-drive vehicles

①	Steering wheel paddle shifters	→	11
②	Instrument display	→	20
③	Start/stop button	→	8
④	 AMG Performance exhaust system	→	9
⑤	 ESP®	→	12

⑥	 AMG adaptive sport suspension system +	→	16
⑦	 Manual gearshifting	→	11
⑧	DYNAMIC SELECT switch	→	9
⑨	AMG steering-wheel buttons	→	8

Operator's Manual

These Operating Instructions provide information on all the important functions of your AMG vehicle that are either not described or differ from the descriptions in the Operator's Manual. This information supplements or replaces the corresponding sections in the vehicle Operator's Manual.

Under no circumstances do the Operating Instructions replace the printed vehicle Operator's Manual and the Digital Operator's Manual in the vehicle.

This Supplement and the Digital Operator's Manual in the vehicle describe the following models, standard and special equipment of your vehicle:

- Models, standard and special equipment available at the time of going to press with these Operating Instructions.
- The models and the standard and special equipment only available in certain countries.
- The models and the standard and special equipment, which will only be available at a later date.

Note that your vehicle may not be installed with all features described. This is also the case for systems relevant to safety. Therefore, the equipment on your vehicle may differ from that in the descriptions and illustrations.

The original purchase agreement for your vehicle contains a list of the equipment in your vehicle at the time of delivery.

Should you have any questions concerning equipment and operation, please consult an authorized Mercedes-Benz Center.

The Operator's Manual, Operating Instructions, further supplementary documents and Maintenance Booklet are important documents and should be kept in the vehicle.

Seat belts

Function of the seat belt extender

The seat belt extender for the front seat helps you fasten your seat belt. When the door is closed, the seat belt extender extends.

The seat belt extender retracts again in the following cases:

- the seat belt tongue is engaged in the seat belt buckle
- The seat belt tongue is not engaged in the seat belt buckle within 60 seconds
- The respective door is opened
- You fold the seat backrest forwards
- Nobody is sitting in the front passenger seat

The seat belt extender must always be retracted while the vehicle is in motion.

Driving

Operation of the AMG steering-wheel buttons

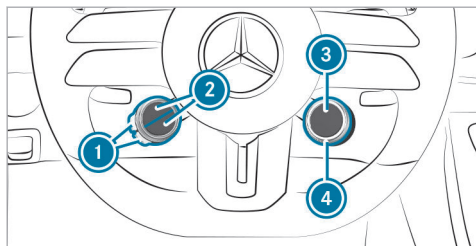

The AMG steering-wheel buttons are two additional control elements on the steering wheel.

You can assign two vehicle functions of your choice to the left control element. You can change between the available functions for corresponding button ① by pressing display buttons ② in the upper or lower area repeatedly. Display buttons ② show the functions currently selected.

The following functions are available:

 ESP® (→ page 12)

 AMG RIDE CONTROL + (→ page 16)

 AMG Performance exhaust system (→ page 9)

 Manual gearshifting (→ page 11)

 AMG Dynamics (→ page 9)

 ECO start/stop function (see the vehicle Operator's Manual)

If you have assigned specific functions to display buttons ②, you can operate these functions with corresponding button ①.

The assignment of display buttons ② remains stored even after a new engine start, but the operating status of the respective function is reset to the basic setting.

You can switch between the drive programs with rotary switch ④. The selected drive program appears in display button ③. By pressing display button ③, you can directly access the  drive program (→ page 9).

Function of the Emotion Start (Mercedes-AMG vehicles)

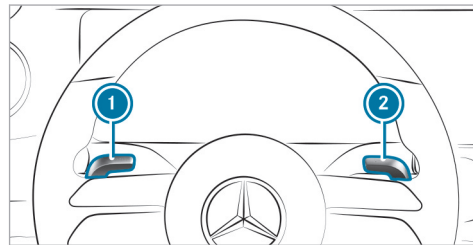

▶ Start the vehicle with the start/stop button and simultaneously pull one of steering wheel paddle shifters ① or ②.

- The idle speed is increased briefly when starting the engine.
- The exhaust gas flaps are opened (sporty characteristic powerful) (→ page 9).

Follow the instructions for starting the vehicle in the operator's manual for the vehicle.

AMG Performance exhaust system

Function of the AMG Performance exhaust system

You can choose between the following sound characteristics for the AMG Performance exhaust system:

- **Balanced:** Comfortable sound characteristic
- **Powerful:** Sporty sound characteristic

Operating the AMG Performance exhaust system

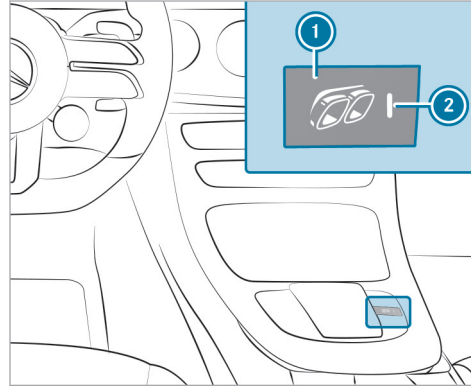

- ▶ Press button ①. The sporty characteristic (powerful) is selected when the ② indicator lamp lights up.

DYNAMIC SELECT switch

Function of the DYNAMIC SELECT switch

Use the DYNAMIC SELECT switch to change between the following drive programs:

- **Slippery:** optimized pulling away and driving characteristics in wintry and slippery road conditions
- **Individual:** individual settings
- **Comfort:** comfortable and economical driving
- **Sport:** sporty driving
- **Sport+:** particularly sporty driving
- **Race:** racetrack-oriented driving characteristics

- ⓘ The drive program is available only for vehicles with the **AMG DYNAMIC PLUS package**.

Drive program may not be used on normal roads. The drive program may be activated and used only on dedicated race circuits, not on public roads.

Mercedes-AMG recommends selecting drive program **[C]** when in city traffic or stop-and-go traffic.

Depending on the drive program selected, the following vehicle characteristics will change:

- Drive
 - Engine and transmission management
- AMG Dynamics
 - The four agility functions, Basic, Advanced, Pro and Master, will be selected automatically depending on the drive program.
 - The steering, shift timing point, all-wheel drive and stabilization functions will be adapted to the selected drive program.
 - When ESP® is activated, the Pro agility function will be selected in drive program **[S]**. The Master function will be selected automatically when ESP® is deactivated.
- Position of the exhaust gas flaps
- Suspension
- Steering

- Drive program **[S]** is characterized by the following:
 - The vehicle exhibits driving characteristics suited for the racetrack.
 - All vehicle systems are set for maximum sportiness.
 - the automatic transmission shifts up later.
 - The suspension exhibits particularly firm springing and damping settings.
 - Glide mode is not available.
 - The sporty sound characteristic of the exhaust system is activated.

i You can call up vehicle characteristics via the Performance menu on the on-board computer (→ page 22).

i You can adjust the agility functions of AMG Dynamics using the AMG steering-wheel buttons.

You can also change the following vehicle characteristics using the buttons on the center console:

- Position of the exhaust gas flaps
- Suspension

Displaying dynamic data

Multimedia system:

↳ **AMG Performance** ▶ **Vehicle**

▶ Select **Dynamic Data**.

Dynamic data is displayed, e.g.:

- G-force values
- Torque distribution
- Boost effect
- Current power output
- Variable all-wheel drive

Automatic transmission

Rocking the vehicle free

Rocking the vehicle free may help to free the vehicle if it has become stuck in slush or snow.

To rock the vehicle free, move the DIRECT SELECT lever upwards and downwards past the point of resistance to switch between transmission positions **[D]** and **[R]**.

- ⓘ The maximum design speed for switching between **D** and **R** is 6 mph (9 km/h).

Manual shifting (Mercedes-AMG vehicles)

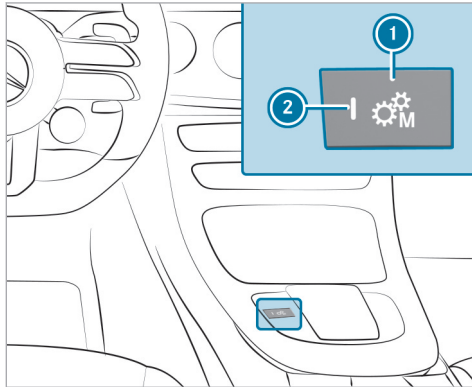

- ▶ **To activate/deactivate:** press button ①. If indicator lamp ② is lit, manual gearshifting is activated. The current gear will be displayed on the instrument display.

- ⓘ To permanently shift the gears manually in drive program **I*** using the steering wheel paddle shifters, select the **M** (Manual) setting for the transmission.

Shifting up and down

- ⚠ **NOTE** Damage to the engine due to shifting up too late

The automatic transmission does not shift up in manual mode even when the engine's limiting speed is reached.

The fuel supply is interrupted in order to prevent the engine from overrevving.

- ▶ Shift up before the engine speed reaches the red area in the tachometer.

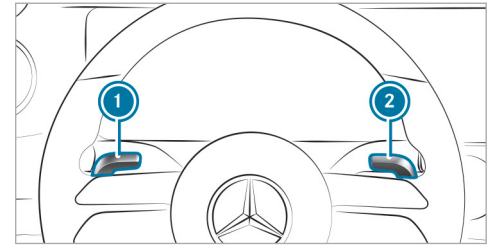

- ▶ **To shift up:** pull steering wheel paddle shifter ②.
- ▶ **To shift down:** pull steering wheel paddle shifter ①.

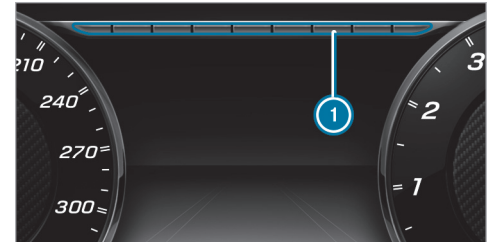

12 Driving and parking

If the engine speed is too high or too low, you will not be able to change gear using the steering wheel paddle shifters. In this case, segments  will light up red.

Function of the glide mode (Mercedes-AMG vehicles)

With an anticipatory driving style, Glide mode helps you to reduce fuel consumption.

Glide mode is characterized by the following:

- The combustion engine is switched off. All of the vehicle functions remain active.
- The  symbol appears in the instrument display.

Glide mode is activated if the following conditions are met:

- ECO start/stop function is switched on.
- Drive program  is selected with the drive setting "Moderate" or "Reduced".
- The speed is within a suitable range.
- The road's course is suitable, e.g. no steep uphill or downhill inclines or tight curves.

- The condition of charge of the battery is sufficient.
- You are no longer depressing the accelerator or brake pedal.

Glide mode is deactivated again if one of the conditions is no longer met.

Driving and driving safety systems

Function of ESP® (Mercedes-AMG vehicles)

You can select between the following modes of the Electronic Stability Program (ESP®):

- ESP® ON
- ESP® SPORT
- ESP® OFF

Characteristics when ESP® is activated

ESP® monitors and improves driving stability and traction, especially in the following situations:

- When pulling away on wet or slippery roads.
- When braking.

- When there is a strong crosswind and the vehicle is traveling at a speed between approximately 47 mph (75 km/h) and 125 mph (200 km/h).

ESP® can stabilize the vehicle by intervening in the following ways:

- One or more wheels are braked.
- The engine output is adapted according to the situation.

ESP® is activated every time the vehicle is started regardless of whether ESP® was in ESP® SPORT or deactivated before the vehicle was switched off.

When the ESP® warning lamp  flashes, one or more wheels have reached their grip limit:



- Adapt the driving style to suit the prevailing road and weather conditions.
- Do not deactivate ESP® under any circumstances.
- Only depress the accelerator pedal as far as necessary.

Characteristics of ESP® SPORT

▲ WARNING Risk of skidding if ESP® SPORT is used incorrectly

When you activate ESP® SPORT, there is an increased risk of skidding and having an accident.

▶ Activate ESP® SPORT only in the circumstances described below.

When ESP® SPORT is selected, the  and  warning lamps light up continuously.

Select ESP® SPORT when the vehicle's own oversteering and understeering characteristics are desired, e.g. on specially designated roads.

Driving with ESP® SPORT or with ESP® deactivated requires an extremely qualified and experienced driver.

If ESP® SPORT is activated and one or more wheels start to spin, the ESP® warning lamp  flashes. ESP® then stabilizes the vehicle only to a limited degree.

ESP® SPORT also has the following characteristics:



- ESP® improves driving stability only to a limited degree.
- ETS/4ETS traction control is still active.
- The engine's torque is restricted only to a limited degree and the driven wheels can spin. The spinning of the wheels results in a cutting action for better traction on loose surfaces.
- ESP® continues to provide assistance when the brakes are firmly applied.
- Crosswind Assist is no longer active.

Characteristics when ESP® is deactivated

▲ WARNING Risk of skidding if ESP® is deactivated

If you deactivate ESP®, ESP® cannot carry out vehicle stabilization.

▶ ESP® should only be deactivated in the following situations.

When ESP® is deactivated, the  and  warning lamps light up continuously.

Deactivating ESP® has the following effects:

- Driving stability will no longer be improved.
 - The driven wheels could spin.
 - ETS/4ETS traction control is still active.
 - Crosswind Assist is no longer active.
- i** Even when ESP® is deactivated, you are still assisted by ESP® when braking hard.
- It may be best to activate ESP® SPORT or deactivate ESP® in the following situations:
- When using snow chains.
 - In deep snow.
 - On sand or gravel.
- i** Spinning the wheels results in a cutting action, which enhances traction.
- i** Activate ESP® as soon as the situations described above no longer apply. ESP® will otherwise not be able to stabilize the vehicle if the vehicle starts to skid or a wheel starts to spin.

If the ESP® warning lamp  lights up continuously, ESP® is not available due to a malfunction. Observe the display messages, warning lamps and indicator lamps that are shown.

- Indicator and warning lamps
- Display messages

ETS/4ETS (Electronic Traction System)

ETS/4ETS traction control is part of ESP®.

ETS/4ETS can improve the vehicle's traction by intervening in the following ways:



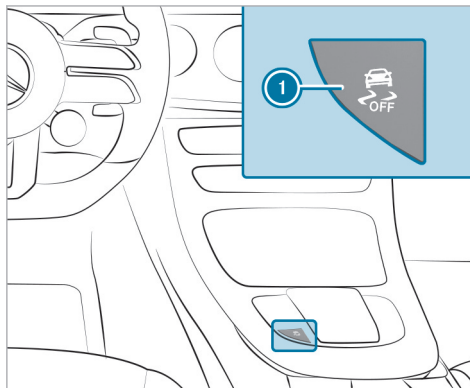

- The driven wheels are braked individually if they spin.
- More drive torque is transferred to the wheel or wheels with traction.

Adjusting ESP® (Mercedes-AMG vehicles)



- ▶ **To activate ESP® SPORT:** briefly press button  1. The  and  warning lamps appear in the instrument cluster.
- ▶ **To deactivate ESP®:** press and hold button  1 until the  and  warning lamps appear in the instrument cluster.

 When you deactivate ESP® in the  drive program, AMG Dynamics automatically switches to the **Master** level.

▶ **To activate ESP®:** briefly press button  1. The ,  and  warning lamps go out.

Observe the information on warning lamps and display messages that are shown in the instrument cluster.

Activating/deactivating ESP® (Electronic Stability Program)

Multimedia system:

  ▶▶ Settings ▶▶ Quick Access

 ESP® can only be activated/deactivated using quick access when at least one other function is available in quick access. ESP® can otherwise be found in the **Assistance** menu.

▶ Select **ESP**.

▶ Select **On** or  **Off**.

ESP® is deactivated if the  ESP® OFF warning lamp lights up continuously in the instrument cluster.

Observe the information on warning lamps and display messages which may be shown in the instrument cluster.

DRIFT MODE

■ Functions of DRIFT MODE

i DRIFT MODE is available only for vehicles with **AMG DYNAMIC PLUS package**.

DRIFT MODE allows you to intentionally make the vehicle unstable and induce oversteer (drifting). All activation conditions must be fulfilled for this (→ page 15).

i Only a highly qualified and experienced driver should drive in DRIFT MODE.
Read the safety notes and information on ESP® (→ page 12).

▲ WARNING Risk of skidding and having an accident from wheels spinning

When you use DRIFT MODE, ESP® is not available.

There is an increased risk of skidding and having an accident.

- ▶ Do not use DRIFT MODE on normal roads.
- ▶ DRIFT MODE may only be activated and used on closed race circuits, not on public roads.
- ▶ Make sure that no persons or obstacles are in the close vicinity of your vehicle.

When DRIFT MODE is active, drive for the vehicle occurs only at the rear and 4MATIC+ is deactivated.

4MATIC+ will be continuously reactivated from a speed of approximately 70 mph (115 km/h) up to 95 mph (150 km/h). From a speed of 95 mph (150 km/h), 4MATIC+ will be fully active again, but ESP® will remain deactivated. 4MATIC+ will be continuously deactivated again below a speed of

95 mph (150 km/h) to approximately 70 mph (115 km/h).

i DRIFT MODE is available only after the vehicle has been run in.

■ Activating and deactivating DRIFT MODE

Requirements

- ESP® is deactivated (→ page 14).
- Drive program  is selected (→ page 9).
- The doors, the hood and the trunk lid/tailgate are closed.
- The vehicle is started and the transmission and the engine are at normal operating temperature.
- The transmission is in manual mode – manual shifting is activated (→ page 11).

Activating DRIFT MODE

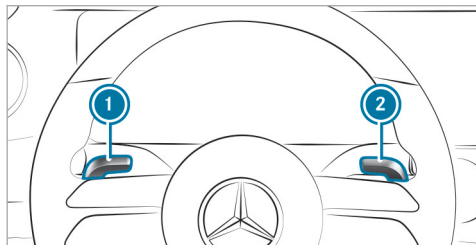

▶ Pull steering wheel paddle shifters ① and ② and hold for half a second. If all activation conditions are fulfilled, the instrument display will show a message reading **DRIFT MODE Confirm: Paddle UP Cancel: Paddle DOWN** and the **DRIFT** warning lamp will flash.

▶ **To cancel:** pull steering wheel paddle shifter ①. The instrument display will show a message reading **DRIFT MODE Canceled** and the **DRIFT** warning lamp will go out.

▶ **To confirm:** pull steering wheel paddle shifter ②. The instrument display will show a message reading **DRIFT MODE Active** and the **DRIFT** warning lamp will light up.

Deactivating DRIFT MODE

▶ Pull steering wheel paddle shifters ① and ② and hold for half a second. The message **DRIFT MODE Active** and the **DRIFT** warning lamp will go out.

DRIFT MODE will automatically be deactivated in the following situations:

- ESP® is activated.
- Manual shifting is deactivated – the transmission is in position **D**.
- The  drive program is switched off.
- The vehicle is switched off.
- Automatic switch-off is required by the vehicle.

① After drifting and before continuing the journey, check the wheels and tires for damage. In particular, check the tire tread depth and

tire contact surface over the entire width of the tires (see the vehicle Operator's Manual).

AMG adaptive sport suspension system +

Function of AMG RIDE CONTROL +

AMG RIDE CONTROL + is an air suspension system with variable damping for improved driving characteristics. The all-round level control system ensures the best possible suspension and constant ground clearance, even with a laden vehicle. When driving at speed, the vehicle is lowered automatically to improve driving safety and to reduce fuel consumption. You also have the option of manually adjusting the vehicle level.

The damping is set individually for each wheel and is affected by the following factors:

- Driving style, e.g. sporty
- Road condition, e.g. bumps
- The individual selection of **SPORT**, **SPORT +** or **COMFORT**

AMG RIDE CONTROL + includes the following components and functions:

- Air suspension with variable spring rate and automatic level control
- Speed-dependent lowering to reduce fuel consumption
- Manually selectable high-level setting for greater ground clearance
- ADS PLUS (Adaptive Damping System with constant damping force adjustment)
- DYNAMIC SELECT switch and level button
- Suspension setting button

Suspension setting and vehicle level per drive program

Drive programs ,  and :



- The suspension setting is comfortable.
- The vehicle is set to the normal level.
- When driving at speeds of 100 mph (160 km/h) or above, the vehicle is lowered.
- When driving at speeds below 87 mph (140 km/h), the vehicle is raised again.

Drive programs ,  and :

- The suspension setting is firmer.
 - The vehicle is set to the low level.
 - The vehicle is not lowered any further if you are traveling at higher speeds.
-  When the vehicle is started again, the **COMFORT** setting is activated automatically.

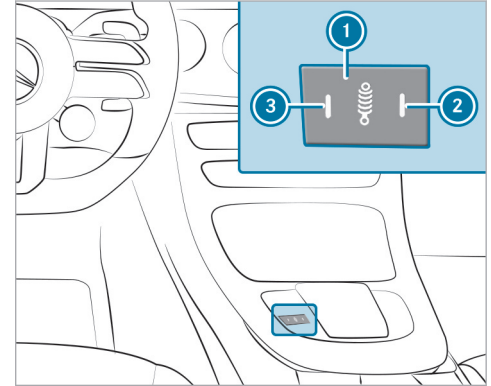
Selecting the AMG RIDE CONTROL+ suspension setting



- ▶ **COMFORT suspension setting:** press button  repeatedly until indicator lamps  and  go out.
The **AMG Suspension System COMFORT** message appears in the Instrument Display.

The driving characteristics of your vehicle are comfortable.

- ▶ **SPORT suspension setting:** press button ① repeatedly until indicator lamp ③ lights up. The **AMG Suspension System SPORT** message appears in the Instrument Display.

The suspension is adapted to be firmer.

- ▶ **SPORT+ suspension setting:** press button ① repeatedly until indicator lamps ② and ③ light up.

The **AMG Suspension System SPORT +** message appears in the Instrument Display.

The vehicle is lowered to low level and the suspension is set to very firm.

Setting the vehicle level

- ⚠ **WARNING** Risk of accident because vehicle level is too high

Driving characteristics may be impaired.

The vehicle can drift outwards, for example, when steering or cornering.

- ▶ Choose a vehicle level which is suited to the driving style and the road surface conditions.

- ⚠ **WARNING** Risk of entrapment from vehicle lowering

When lowering the vehicle, people could become trapped if their limbs are between the vehicle body and the tires or underneath the vehicle.

- ▶ Make sure no one is underneath the vehicle or in the immediate vicinity of the wheel arches when the vehicle is being lowered.

- ⚠ **WARNING** Risk of becoming trapped due to the vehicle lowering

Vehicles with AIR BODY CONTROL or level control system: when you unload luggage or leave the vehicle, the vehicle first rises slightly and then returns to the set level shortly afterwards.

You or anyone else in the vicinity of the wheel arches or the underbody could thus become trapped.

The vehicle can also be lowered after being locked.

- ▶ When leaving the vehicle, make sure that nobody is in the vicinity of the wheel arches or the underbody.

Requirements:

- The vehicle has been started.
- The vehicle is not moving faster than 40 mph (65 km/h).

Raising the vehicle

- ▶ Select  in the quick access menu of the multimedia system. The vehicle is raised to the high level.

Your selection is saved.

The vehicle lowers itself back down to the height of the most recently active drive program:



- When driving faster than 62 mph (100 km/h).

- When driving between 50 mph (80 km/h) and 62 mph (100 km/h) for approximately three minutes.
- After selecting a drive program using the DYNAMIC SELECT switch.

Lowering the vehicle

- ▶ Select . The vehicle is adjusted to the height of the last active drive program.

Notes on the instrument display and on-board computer

- **Vehicles with an instrument display (standard):** if you activate manual gearshifting (→ page 11), the gearshift recommendation will appear on the instrument or head-up display. In addition, the drive setting **M** (manual) and the current gear will appear on the transmission position display of the instrument display.
- The vehicle is also equipped with the following indicator and warning lamps (→ page 39):
 - ESP® 
 - ESP® OFF 
 - ESP® SPORT 

In vehicles with widescreen cockpit, you can select display content including the following:

- Tachometer with gear display
- Date and time
- Warm-up
- AMG TRACK PACE

- G-meter
- Engine data
- SETUP
- Trip computer
- Navigation
- Media
- Telephone

The AMG TRACK PACE menu is displayed in the left-hand section of the display.

The following menus are displayed in the right-hand section of the display:

- Warm-up
- G-meter
- Engine data
- SETUP

Operating the on-board computer

⚠ WARNING Risk of distraction from information systems and communications equipment

If you operate information systems and communication devices integrated in the vehicle when driving, you could be distracted from the traffic situation. This could also cause you to lose control of the vehicle.

- ▶ Only operate this equipment when the traffic situation permits.
- ▶ If you cannot be sure of this, stop the vehicle whilst paying attention to road and traffic conditions and operate the equipment with the vehicle stationary.

Observe the legal requirements for the country in which you are currently driving when operating the on-board computer.

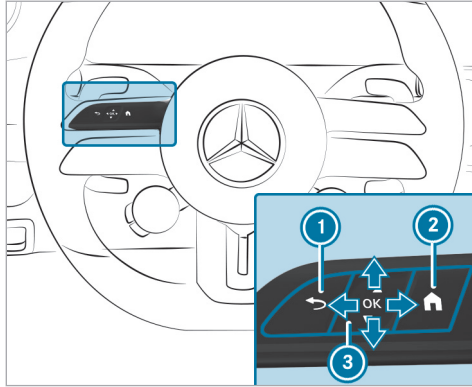

- ① Back button
- ② Main menu
- ③ Touch Control

The on-board computer is operated using the left-hand Touch Control, back button and main menu button.

When the on-board computer is being operated, different acoustic signals will sound as operating feedback, e.g. when you reach the end of a list.

- ① To operate Touch Control ③ in the most effective way, use the tip of your thumb if possible.

The following menus are available:

- Assistance
- Phone
- Navigation
- Performance
- Trip
- Radio
- Media
- Designs
- Service

The menus can be called up from the menu bar on the instrument display.

- ▶ To call up the menu bar: press the left-hand back button until the menu bar is displayed.

- ① Vehicles without Active Distance Assist DISTRONIC: press the  button to call up the menu bar of the on-board computer.

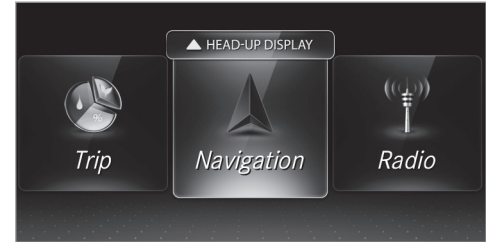

- ▶ To scroll on the menu bar: swipe to the left or right on the left-hand Touch Control.
- ▶ To call up a menu or confirm a selection: press the left-hand Touch Control.
- ▶ To scroll through displays or lists on the menu: swipe upwards or downwards on the left-hand Touch Control.
- ▶ To call up a submenu or confirm a selection: press the left-hand Touch Control.

- ▶ **To exit a submenu:** press the left-hand back button.

Operating the head-up display

- ▶ **If the head-up display is switched off:** swipe upwards on the menu bar on the left-hand Touch Control.
- ▶ **To switch to the head-up display:** swipe upwards on the left-hand Touch Control.
- ▶ **To set the display areas of the head-up display:** swipe upwards or downwards on the left-hand Touch Control.

Displaying full-screen menus

You can display the following menus full-screen on the instrument display:

- Assistance
 - Trip
 - Navigation
- ▶ On the corresponding menu, use the left-hand Touch Control to scroll to the end of the list.

- ▶ Press the left-hand Touch Control. The selected menu will be displayed full-screen.

Calling up displays on the Performance menu

On-board computer:

↳ Performance

- ▶ **To select a display:** swipe upwards or downwards on the left-hand Touch Control.

Displays on the Performance menu:

- Warm-up
- Engine data
- SETUP
- G-meter

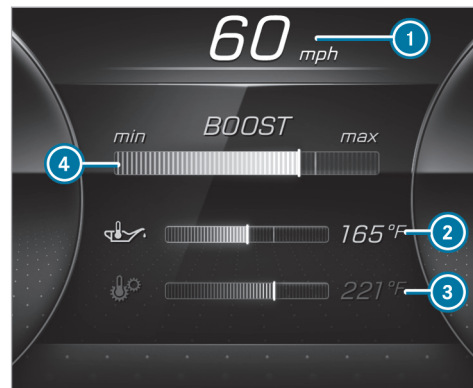

Warm-up

- ① Digital speedometer
- ② Engine oil temperature
- ③ Transmission oil temperature
- ④ Boost pressure

If the engine or transmission is not at normal operating temperature, the instrument display will

show temperature ② or ③ in blue. Avoid using the full engine power output during this time.

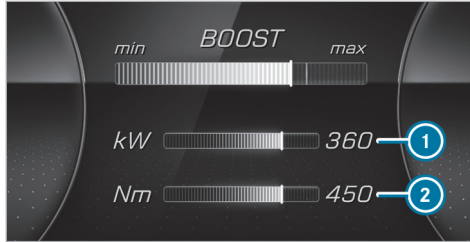

Engine data

- ① Current power output
- ② Current torque

When the current power output ① or the current torque ② reaches the maximum value, the digital value will briefly be stationary and will turn red. The bar display will continue.



SETUP

- ① Drive system setting:
Reduced/Moderate/Sport/Dynamic/Race
- ② Transmission position:
D/M
- ③ AMG DYNAMICS:
Basic/Advanced/Pro/Master
- ④ Suspension tuning:
Comfort/Sport/Sport+
- ⑤ Exhaust system:
Balanced/Powerful

Resetting the G-meter

While the vehicle is in motion, the G-meter shows the forces that are exerted on the vehicle occupants both laterally and in the direction of travel. The maximum values are represented by red markings.



G-meter

- ▶ Press the left-hand Touch Control.
- ▶ Select **Yes**.
- ▶ Press the left-hand Touch Control.

Function of the head-up display

The head-up display projects the following information into the driver's field of vision above the cockpit, for example:

- Driving speed
- Information from the navigation system
- Information from the driving systems and driving safety systems
- Some warning messages

Depending on the vehicle's equipment, different content may be shown in the three areas of the head-up display.

Mercedes-AMG display content

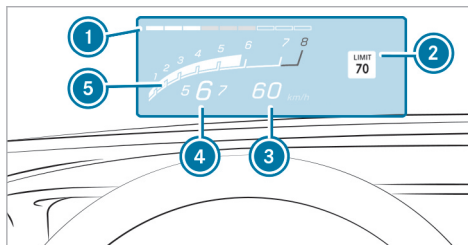

- 1 Protection from reaching the overrevving range
- 2 Detected instructions and traffic signs
- 3 Current speed
- 4 Currently selected gear; gearshift options for manual shifting
- 5 Current engine speed

Depending on the vehicle's equipment, you can select further AMG displays in addition to the standard displays on the [Display Content](#) menu.

In vehicles with AMG TRACK PACE, you can display additional content:

- Speed and gear display
- Lap and sector times
- Acceleration and braking
- Track layout graphics

i The content that can be displayed will vary depending on the settings.

When you receive a call, the  **Incoming Call** message will appear on the head-up display.

In audio mode, the station name or track will be shown temporarily when the audio source is being actively operated.

System limits

The visibility of the displays will be affected by the following conditions:

- Seat position
- Image position setting
- Ambient light
- Wet road surface
- Objects on the display cover

- Polarization in sunglasses
- ① In extreme sunlight, sections of the display may appear washed out. You can correct this by switching the head-up display off and on again.

AMG TRACK PACE

Function of AMG TRACK PACE

- i** This function is an on-demand feature and can be activated via Mercedes me after you purchase your vehicle. The Digital Operator's Manual contains further information on Mercedes me and on-demand features.

With AMG TRACK PACE, the driving characteristics on race tracks can be analyzed and optimized. You can drive previously saved race tracks (e.g. Hockenheimring), or record and save new tracks. The driven lap times are stored for every track. These can be analyzed and compared to other lap times to achieve the best possible race results. Additionally, acceleration and braking procedures can be measured and stored.



Note: Use AMG TRACK PACE only on closed-off routes outside the public traffic area. Adapt your driving style to your personal performance and environmental conditions. As the driver, you are solely responsible for driving your vehicle. Park your vehicle safely before operating the application.

Setting Track Race



Multimedia system:



↳ TRACK PACE ▶▶ Track Race

Recording a new track

- ▶ Select  **New Track**.
- ▶ Select  **Start Record** at the desired starting point.
The track recording starts at this point.

During track recording, sectors can be set to divide up the track.



- ▶ Select  **Set Sector**.
- ▶ Select  **Stop Recording** to end track recording or cross the starting line again.
- ▶ Confirm the prompt with .
- ▶ Select the weather.

- i** The temperature is determined automatically.
- ▶ After ending, select  to save the track.
- ▶ Enter a name.
- ▶ Press  to confirm.
The track is saved under the name entered.

Searching by track name



- ▶ Select  **All Tracks**.
- ▶ Enter the track name.
Tracks with the searched name are displayed.

Measuring time on a saved track

- ▶ Select  **All Tracks**.
- ▶ Select the desired track.
- ▶ Select .
- ▶ Select **Start Race** if you are already stood at the starting line.

or



- ▶ Select **Navigate to** for navigation to the starting line.
Timekeeping begins automatically when the starting line has been crossed.

- i** When  is selected, the track display can be switched to AR.
- ▶ Select  **Stop Race** to end timekeeping.
- ▶ Confirm the prompt with .
- ▶ Select the weather.

- ▶ Select  **Save Track** to save the times driven for this track.

Showing displays during Track Race

The following displays can be shown:

- Tire temperature
 - Mini map
 - Sector overview
 - Engine data
 - G-force display
 - Lap overview
- ▶ Select  **Start Race**.
 - ▶ Select  **Setup**.





- ▶ Pull the desired display from the grid on the left or right edge of the media display. The displays are shown during the Track Race.

By selecting  on the active display, you can deactivate this.

- ▶ Select  to return to the navigation map view.

Displaying the analysis

- ▶ Select  **All Tracks** . An overview of all the driven tracks appears.
 - ▶ Select a track.
 - ▶ Select a session.
- The following data is displayed:
- Lap and sector times
 - Average and maximum permissible speed
 - Driver

- Vehicle
 - Date
 - Weather
- ▶ Select **Compare to Rec.** to use a different session as a reference value.
 - ▶ Select  to return to the overview.
 - ▶ Select  **Diagram**.
 - ▶ Set parameters  and . The analysis is displayed.

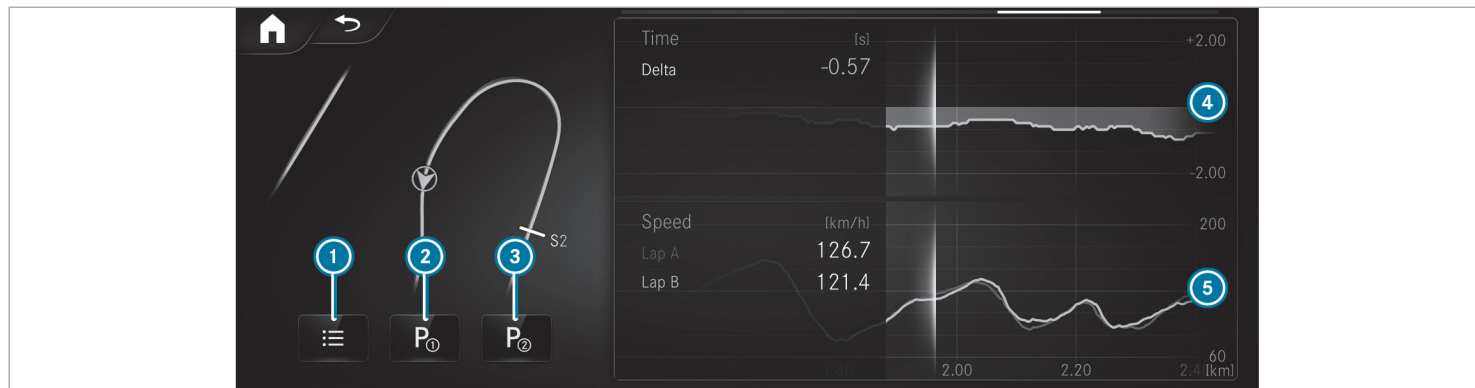



- ① Lap overview
 - ② Parameter 1
 - ③ Parameter 2
 - ④ Trajectory of parameter 1 (e.g. time)
 - ⑤ Trajectory of parameter 2 (e.g. speed)
- ⑧ The following values can be set for parameters 1 and 2, for example:
- Speed



- Longitudinal/lateral acceleration
- Steering angle
- Engine speed
- Engine oil/tire temperature

Based on the analysis you can check and optimize driving characteristics for any position on the track.

Exporting tracks (USB)

- ▶ Select  **Tracks**.
An overview of all stored tracks appears.
- ▶ Select the desired track.
- ▶ Select options  for the desired track.
- ▶ Select **Export**.
The selected track can be exported to a USB storage device connected to the vehicle.

Editing tracks and recordings

- ▶ Select  **Tracks**.
- ▶ Select the desired track.
- ▶ Select options  for the desired track.
- ▶ Select **Rename** or **Delete**.

or

- ▶ Select a track.
- ▶ Highlight the desired recording.
- ▶ Select  options.
- ▶ Select **Export to...** or **Delete**.

Setting Drag Race

Multimedia system:

↳ **TRACK PACE** ▶ **Drag Race**

Measuring acceleration

- ▶ Select  **Drag Options**.
- ▶ Select **Acceleration**.
- ▶ Set a starting speed or select **Automatic**.
Measurement begins as soon as the specified starting speed has been reached.

- ▶ Set a target speed.
Measurement stops as soon as the specified target speed has been reached.
- ▶ Pull away and start the measurement.
Measurement begins when the vehicle accelerates.

Measurement can be stopped early by stopping the vehicle.

Quarter-mile race

- ▶ Select  **Drag Options**.
- ▶ Select **Quarter Mile**.
- ▶ Set a target distance.
Measurement stops as soon as the specified target distance has been reached.
- ▶ Pull away and start the measurement.
Measurement begins when the vehicle accelerates. Timing runs until the target distance or a maximum of one mile has been traveled.

Measurement can be stopped early by stopping the vehicle.

Measuring braking

- ▶  **Drag Options**
- ▶ Select **Braking**.
- ▶ Set a starting speed or select **Automatic**.
- ▶ Pull away and start the measurement.
- ▶ Brake to a standstill.
Measurement is incremental, in steps of 5 mph (10 km/h) to a standstill. If the braking procedure is started e.g. at a speed of 58 mph (157 km/h), measurement starts as soon as 55 mph (150 km/h) has been reached.

Storing and calling up measurement values

If measurement is completed or canceled, a prompt appears asking whether the measurement should be saved.

- ▶ Confirm the prompt with  to save.

Calling up saved measurements

- ▶ Select  **History**.
- ▶ Select **Acceleration**, **Quarter Mile** or **Braking**.
- ▶ Select a measurement.
The desired measurement is displayed in detail.

or

- ▶ Delete a measurement.

Calling up the telemetry display

Multimedia system:

↳ TRACK PACE ▶ Telemetry

The telemetry display shows current vehicle data as a digital value and as a diagram. Up to three parameters can be selected that are to be shown in the display.

For example:

- Engine speed
- Wheel angle
- Speed
- Steering angle

- ▶ Set the desired parameters.

- ▶ Set the time.

The set parameters are evaluated in the diagram for the time set.

Configuring AMG TRACK PACE

Requirements:

To connect a mobile device to the TRACK PACE app:

- The TRACK PACE app is installed on the mobile end device.
- The mobile end device is connected to the multimedia system via Wi-Fi.

Multimedia system:

↳ TRACK PACE ▶ Options

Connecting a mobile device via the TRACK PACE app

The TRACK PACE app makes it possible to record videos and to synchronize them with stored tracks.

- ▶ Select **TRACK PACE App**.
- ▶ Select **AUTHORIZE NEW DEVICE**. Available devices are displayed.
- ▶ Start the TRACK PACE app on the device to be connected and follow the instructions.
- ▶ Confirm the authorization prompt.

- ▶ Scan the QR code on the media display. The device is authorized.

De-authorizing the mobile device

- ▶ Select **TRACK PACE App**.
- ▶ Select **De-authorize device**.
- ▶ Select a device.
- ▶ Confirm the message prompt with Yes. The device is de-authorized.

Setting the TRACK PACE display in the Head-up Display

- ▶ Select **HUD Content**.
- ▶ Activate or deactivate the desired contents. The contents in the Head-up Display are adapted.
- ⓘ For further information on the Head-up Display, see (→ page 24).

Setting acoustic feedback

- ▶ Select **Acoustic feedback**. A scale with values from 0 to 85 is shown.
- ▶ Select a setting.

Displaying statistics

- ▶ Select **Statistics**.
Statistics on the current user profile are displayed.

The following data is displayed:

- Driving time
- Track driven
- Tracks recorded
- Track Races recorded
- Laps recorded
- Drag Races recorded
- Maximum design speed

Activating the ambient light

If this function is active, the vehicle interior is lit red or green depending on Delta Time.

- ▶ Select **Ambient light**.
- ▶ Activate or deactivate the function.

Notes on the care of tailpipes

⚠ WARNING Risk of burns from the tailpipe and tailpipe trims

The exhaust tailpipe and tailpipe trims can become very hot. If you come into contact with these parts of the vehicle, you could burn yourself.

- ▶ Always be particularly careful around the tailpipe and the tailpipe trims and supervise children especially closely in this area.
- ▶ Allow vehicle parts to cool down before touching them.

Observe the following notes in order to prevent damage to the vehicle:

- Clean the tailpipes with a cleaning agent recommended for Mercedes-Benz, especially in the winter and after washing the vehicle.
- Do not use acidic cleaning agents.

Changing a wheel

- ▶ Be sure to also observe the notes on changing a wheel in the Operator's Manual of your vehicle.

Vehicles with AMG Driver's Package:

⚠ WARNING Risk of accident caused by non-approved tire types

If you use tire types that have not been adapted to changes made to the factory speed limit, this can have the following consequences:

- The tires are not suitable for high speeds and the corresponding driving dynamics.
- The tires wear unevenly and affect the roadworthiness of the vehicle.
- ABS, ESP® and cruise control operation are restricted.

This can jeopardize road safety.

- ▶ Only use tire types that have been approved for the maximum permissible speed set and the vehicle.

Operating fluids

Fuel

Information on fuel quality for Mercedes-AMG vehicles

Observe the information on operating fluids in the vehicle Operator's Manual.

! NOTE Damage caused by the wrong fuel

Even small amounts of the wrong fuel could result in damage to the fuel system, the engine and the emission control system.

- ▶ Only refuel with low-sulfur spark-ignition engine fuel.

This fuel may contain up to 10% ethanol by volume. Your vehicle is suitable for use with E10 fuel.

Never refuel with one of the following fuels:

- diesel
- Gasoline with more than 10% ethanol by volume, e.g. E15, E85, E100

- Gasoline with more than 3% methanol by volume, e.g. M15, M30, M85, M100
- Gasoline with additives containing metal

If you have accidentally refueled with the wrong fuel:

- ▶ Do not switch on the vehicle.
- ▶ Consult a qualified specialist workshop.

If the available fuel is not sufficiently low in sulfur, it may produce unpleasant odors.

Refuel using only premium-grade unleaded gasoline of at least 91 AKI/95 RON.

As a temporary measure, if the recommended fuel is not available, you may also use regular unleaded gasoline. When doing this, note the octane number on the vehicle on the information label on the fuel filler flap (see the vehicle Operator's Manual). Filling up with regular unleaded gasoline can reduce engine output and increase fuel consumption.

Never refuel using gasoline of an even lower RON.

! NOTE Premature engine wear through unleaded regular gasoline

Impairment of the longevity and performance of the engine.

If unleaded premium grade gasoline is unavailable and you have to refuel using unleaded regular gasoline:

- ▶ Only fill the fuel tank to half full with unleaded regular gasoline and refill as soon as possible with unleaded premium grade gasoline.
- ▶ Do not drive at the maximum design speed.
- ▶ Avoid sudden acceleration and engine speeds over 3000 rpm.

Further information on fuel is available at the following locations:

- At a gas station
- At a qualified specialist workshop
- **USA only:** on the <https://www.mbusa.com>

Tank content and fuel reserve

Coupe and convertible

Model	Total capacity
Mercedes-AMG E 53 4MATIC+	17.4 gal (66.0 liters)
Model	Of which reserve
Mercedes-AMG E 53 4MATIC+	1.8 gal (7.0 liters)

Engine oil quality and filling capacity

Coupe and convertible

Model	MB-Freigabe or MB-Approval
Mercedes-AMG E 53 4MATIC+	229.51, 229.52, 229.61, 229.71 229.72*

* Recommended for lowest possible fuel consumption (lowest SAE viscosity class in each

case; observe possible restrictions of the approved SAE viscosity classes)

To achieve the lowest possible fuel consumption, it is recommended to use the engine oil specifications marked in the table with the lowest SAE viscosity class. Possible restrictions of the approved SAE viscosity classes must be observed.

The following values refer to an oil change, including the oil filter.

Coupe and convertible

Model	Capacity
Mercedes-AMG E 53 4MATIC+	9.0 US qt (8.5 liters)

Coolant filling capacity

Coolant (engine)

Model	Capacity
Mercedes-AMG E 53 4MATIC+ (Coupe and convertible)	11.7 US qt (11.1 liters)

Filling capacity for refrigerant and PAG oil

Capacity

Model	Refrigerant
Mercedes-AMG E 53 4MATIC+ (Coupe and convertible)	21.5 ± 0.4 oz (610 ± 10 g)
Model	PAG oil
Mercedes-AMG E 53 4MATIC+ (Coupe and convertible)	4.9 ± 0.4 oz (140 ± 10 g)

Vehicle data

Vehicle dimensions

The heights specified may vary as a result of the following factors:

- Tires
- Load
- Condition of the suspension
- Optional equipment

Vehicle dimensions

Mercedes-AMG E 53 4MATIC+ (Coupe)	
Vehicle length	190.8 in (4846 mm)
Vehicle width including exterior mirrors	80.9 in (2055 mm)
Vehicle height	56.3 in (1430 mm)
Wheelbase	113.1 in (2873 mm)
Turning circle	40.4 ft (12.3 m)

Vehicle dimensions

Mercedes-AMG E 53 4MATIC+ (convertible)	
Vehicle length	190.8 in (4846 mm)
Vehicle width including exterior mirrors	80.9 in (2055 mm)
Vehicle height	56.1 in (1426 mm)

Mercedes-AMG E 53 4MATIC+ (convertible)

Vehicle height when opening/closing the roof	79.0 in (2006 mm)
Wheelbase	113.1 in (2873 mm)
Turning circle	40.4 ft (12.3 m)

Weights and loads

Please observe the following notes for the specified vehicle data:

- Items of optional equipment increase the curb weight and reduce the payload.
- You will find vehicle-specific weight information on the vehicle identification plate (see the vehicle Operator's Manual).

Missing values were not available at time of going to print.

Roof load

Model	Maximum roof load
Mercedes-AMG E 53 4MATIC+ (Coupe)	

Maximum design speeds

The maximum design speed can differ from the stated figures in practice. It depends on the operating conditions, optional equipment and tire size.

Mercedes-AMG vehicles

The following values only apply to vehicles with the AMG Driver's Package.

Missing values were not available at time of going to print.

Maximum design speed

Model	
Mercedes-AMG E 53 4MATIC+ (Coupe and convertible)	

Display messages

Driving systems

Display messages	Possible causes/consequences and ► Solutions
<p>DRIFT MODE Currently Unavailable See Operator's Manual</p>	<p>* Possible causes:</p> <ul style="list-style-type: none"> • The activation conditions have not been fulfilled (→ page 15).
<div data-bbox="205 433 362 515" data-label="Image"> </div> <p>Malfunction Drive at Max. 50 mph</p>	<p>* The AMG adaptive sport suspension system is malfunctioning. The vehicle's handling characteristics may be affected.</p> <ul style="list-style-type: none"> ► Do not drive at speeds greater than 50 mph (80 km/h). ► Consult a qualified specialist workshop.
<p>AMG Suspension System Function Limited See Operator's Manual</p>	<p>* At least one of the main functions of the AMG adaptive sport suspension system + is malfunctioning. The system is outside the operating temperature range or the on-board electrical system voltage is too low. Once the cause of the problem is no longer present, the system will be available again.</p> <div data-bbox="556 715 1696 778" data-label="Text"> <p>! NOTE The vehicle's suspension and damping behavior is restricted. The vehicle body may tilt heavily to the side during cornering.</p> </div> <ul style="list-style-type: none"> ► Drive on carefully. ► Reduce speed considerably before taking a bend.

Display messages	Possible causes/consequences and ► Solutions
	<ul style="list-style-type: none"> <li data-bbox="513 256 888 280">▶ Avoid sudden steering movements. <li data-bbox="513 311 704 335">▶ Drive on carefully. <li data-bbox="513 346 1012 369">▶ Reduce speed considerably before taking a bend. <li data-bbox="513 380 870 404">▶ Avoid sudden steering movements.

Warning and indicator lamps

Driving systems

Warning/indicator lamp	Possible causes/consequences and ► Solutions
<div data-bbox="155 619 312 702" style="border: 1px solid black; padding: 5px; text-align: center;">  </div> <p data-bbox="144 712 397 757">Suspension warning lamp (yellow)</p>	<p data-bbox="463 622 1179 667">* The yellow AMG adaptive sport suspension system + warning lamp is lit. There is a malfunction in the AMG adaptive sport suspension system +.</p> <ul style="list-style-type: none"> <li data-bbox="476 681 957 705">▶ Note the messages on the instrument display.

Warning/indicator lamp	Possible causes/consequences and ► Solutions
 <p>DRIFT MODE warning lamp</p>	<p>* DRIFT MODE is activated while the engine is running.</p> <div style="border: 1px solid gray; padding: 5px; margin: 5px 0;"> <p>⚠ WARNING Risk of skidding and having an accident from wheels spinning</p> <p>When you use DRIFT MODE, ESP[®] is not available. There is an increased risk of skidding and having an accident.</p> <ul style="list-style-type: none"> ▶ Do not use DRIFT MODE on normal roads. ▶ DRIFT MODE may only be activated and used on closed race circuits, not on public roads. ▶ Make sure that no persons or obstacles are in the close vicinity of your vehicle. </div> <p>► Observe the notes on activating DRIFT MODE (→ page 15).</p>

Driving safety systems



Warning/indicator lamp	Possible causes/consequences and ► Solutions
	<p>* The yellow ESP[®] OFF warning lamps are lit while the vehicle is running. ESP[®] is deactivated.</p> <p>Other driving systems and driving safety systems may also be inoperative.</p>

Warning/indicator lamp	Possible causes/consequences and ► Solutions
	<p>▲ WARNING Risk of skidding when driving with ESP® deactivated</p> <p>ESP® does not act to stabilize the vehicle. The availability of further driving safety systems is also limited.</p> <ul style="list-style-type: none"> ▶ Drive on carefully. ▶ Deactivate ESP® only for as long as the situation requires. <p>If ESP® cannot be activated, ESP® is malfunctioning.</p> <ul style="list-style-type: none"> ▶ Have ESP® checked immediately at a qualified specialist workshop. <p>► Observe the notes on deactivating ESP® (→ page 12).</p>
 <p>The icon shows a car with a wavy line underneath it, indicating a skid or loss of control. Below the car, the word "OFF" is written in a bold, sans-serif font. Below the "OFF" text, the words "ESP SPORT" are written in a bold, sans-serif font. The entire icon is enclosed in a rectangular border.</p>	<p>* ESP® SPORT is activated while the vehicle is running. When ESP® SPORT is activated, ESP® will stabilize the vehicle only to a limited extent.</p> <p>▲ WARNING Risk of skidding if ESP® SPORT is used incorrectly</p> <p>When you activate ESP® SPORT, there is an increased risk of skidding and having an accident.</p> <ul style="list-style-type: none"> ▶ Activate ESP® SPORT only in the circumstances described below. <p>► Observe the notes on activating ESP® SPORT(→ page 12).</p>

A		Oil temperature (on-board computer, Performance menu)..... 22	D	
AMG		Steering wheel paddle shifters..... 11	Dashboard	
Menu (on-board computer).....	20		Cockpit.....	4
AMG adaptive sport suspension system +		B	DIRECT SELECT lever	
Setting the vehicle level.....	18	Boost pressure (on-board computer, Performance menu).....	Manual gearshifting.....	11
AMG performance exhaust system			Display messages	
Function.....	9	C	 Malfunction Drive at Max. 50	
Operating.....	9	Care	mph.....	37
AMG RIDE CONTROL +		Tailpipes.....	AMG Suspension System Function	
Function.....	16		Limited See Operator's Manual.....	37
Selecting the suspension setting.....	17	Changing a wheel	DRIFT MODE Currently Unavailable	
AMG steering-wheel buttons		Mounting a new wheel.....	See Operator's Manual.....	37
Function.....	8	Removing a wheel.....		
AMG TRACK PACE		Climate control	Drag Race	
Configuring.....	30	Filling capacity for refrigerant and	Setting.....	29
Drag Race.....	29	PAG oil.....		
Function.....	26	Cockpit	DRIFT MODE	
Telemetry display.....	30	Dashboard.....	Activating.....	15
Track Race.....	26		Activation conditions.....	15
Automatic transmission		Coolant (engine)	Deactivating.....	15
Drive programs.....	9	Capacity.....	Function.....	15
DYNAMIC SELECT switch.....	9		Drive programs.....	9
Manual gear shifting.....	11			

Driving safety system			
ESP® (Electronic Stability Program).....	12	Setting.....	14
Driving system		ESP® (Electronic Stability Program)	
AMG RIDE CONTROL +.....	16	Activating/deactivating (button).....	14
Dynamic data		Status display (on-board computer, Performance menu).....	22
Displaying.....	10	Exhaust system	9
DYNAMIC SELECT			
Drive programs.....	9	F	
Function.....	9	Fuel	
E		E10.....	34
E10	34	Flexible fuel vehicles.....	34
Electronic Stability Program	12	Gasoline.....	34
Emotion Start	8	Gasoline quality.....	34
Engine oil		Reserve.....	35
Capacity.....	35	Sulfur content.....	34
MB-Freigabe / MB-Approval.....	35	Tank content.....	35
Quality.....	35	Fuel reserve	35
Temperature (on-board computer, Per- formance menu).....	22	G	
ESP®		G-Meter (on-board computer, Perform- ance menu)	22
ESP® SPORT.....	12	Gasoline	34
Function.....	12		
		Gear display (on-board computer, Per- formance menu)	22
		Gearshift	
		Manual.....	11
		Glide mode	12
		H	
		Head-up display	
		Function.....	24
		I	
		Instrument display	
		AMG displays.....	20
		Head-up display.....	24
		Performance menu.....	22
		L	
		Level control	
		AMG RIDE CONTROL +.....	16
		M	
		Maximum speed (Mercedes-AMG vehicles)	36

Menu (on-board computer)			
AMG displays.....	20		
Overview.....	20		
Performance.....	20, 22		
O			
On-board computer, Operating system			
AMG menu.....	20		
Menu overview.....	20		
Operating.....	20		
Performance menu.....	20		
Operating fluids			
Gasoline.....	34		
Operator's manual	6		
P			
Paddle shifters			
Steering wheel paddle shifters.....	11		
Performance (on-board computer, Performance menu)	22		
Power output (on-board computer, Performance menu)	22		
Programs	9		
R			
Racetrack mode			
AMG steering-wheel buttons.....	8		
Reserve			
Fuel.....	35		
Rocking free	10		
Roof load	36		
S			
Seat belt extender	7		
Seat belts			
Seat belt extender.....	7		
Selecting a gear	11		
SETUP (on-board computer, Performance menu)	22		
Shifting			
Automatic transmission.....	11		
Manual.....	11		
Steering wheel paddle shifters.....	11		
Sports exhaust	9		
Start/stop button			
Emotion Start.....	8		
Steering wheel paddle shifters	11		
Sulfur content	34		
Suspension			
AMG RIDE CONTROL +.....	16		
Selecting the suspension setting.....	17		
Setting the vehicle level.....	18		
Suspension level			
Setting.....	18		
T			
Tailpipes			
Care.....	32		
Tank content			
Fuel.....	35		
Reserve.....	35		
Technical data			
Roof load.....	36		
Telemetry display			
Calling up.....	30		
Temperature			
Engine oil (on-board computer, Performance menu).....	22		

- Transmission oil (on-board computer, Performance menu)..... 22
- Tires**
- Mounting..... 33
- Removing..... 33
- Torque (on-board computer, Performance menu)..... 22**
- Touch Control**
- On-board computer..... 20
- Track Race**
- Setting..... 26
- Trunk lid**
- Opening dimensions..... 35
- V**
- vehicle**
- Emotion Start..... 8
- Equipment..... 6
- Rocking free..... 10
- Vehicle data**
- Maximum speed (Mercedes-AMG vehicles)..... 36
- Roof load..... 36
- Turning circle..... 35
- Vehicle height..... 35
- Vehicle length..... 35
- Vehicle width..... 35
- Wheelbase..... 35
- Vehicle dimensions..... 35**
- Vehicle equipment..... 6**
- W**
- Warm-up (on-board computer, Performance menu)..... 22**
- Warning/indicator lamp**
-  DRIFT MODE warning lamp..... 39
-  Suspension warning lamp (yellow).. 38
- Wheels**
- Mounting..... 33
- Removing..... 33