



E-Class Wagon

Brief Instructions

Mercedes-Benz



Cockpit – overview

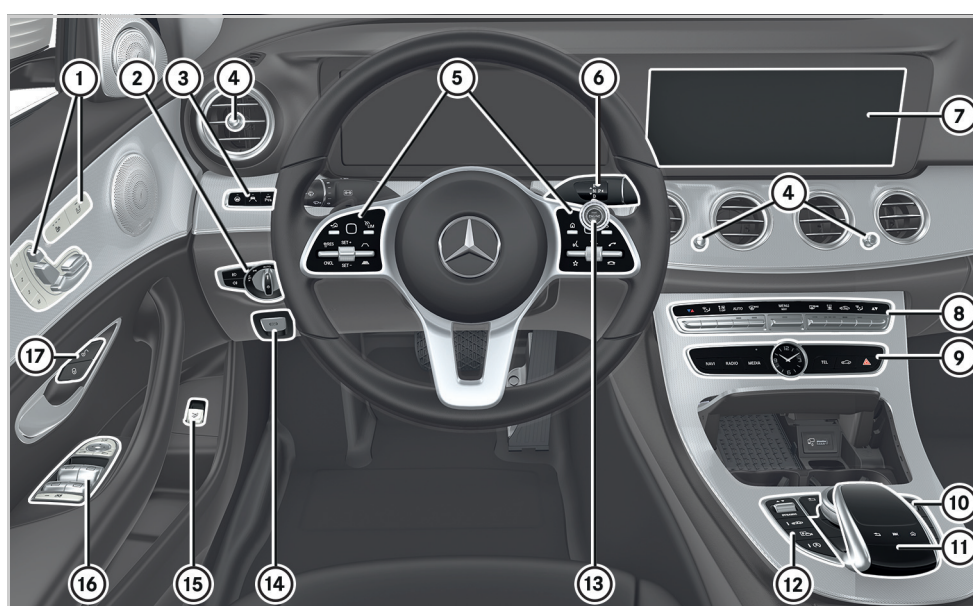

- ① **Seat functions**
 - Adjusts the seat electrically
 - Seat heating
 - Seat ventilation
 - Adjusts the front passenger seat
 - Memory function and memory presets **1 2 3**
- ② Light switch
- ③ **Driver assistance systems**
 - Active Steering Assist
 - Active Lane Keeping Assist
 - Switches off Parking Assist PARKTRONIC
Depending on the vehicle's equipment, the button may also be at position ⑫.
 - Head-up Display
- ④ Adjusts the air vents
- ⑤ Multifunction steering wheel control panels

⚠ WARNING Make sure that you read the entire Operator's Manual. Otherwise, you may not recognize dangers.

Cockpit – overview

- ⑥ **DIRECT SELECT lever**
- ⑦ **Multimedia system display**
- ⑧ **Buttons for automatic climate control**
- ⑨ **Direct buttons for main functions of the multimedia system**
 - Navigation menu
 - Radio menu
 - Media menu
 - Telephone menu
 - Vehicle menu
 - Hazard warning lights
- ⑩ **Multimedia system controller**
 - Adjusts the volume
 - Press: Mute function
 - Switches the multimedia system on/off
 - Lowers the head restraints in the rear passenger compartment
 - Multimedia system main menu
 - Back button

- ⑪ **Multimedia system touchpad**
- ⑫ **Driving functions**
 - DYNAMIC SELECT
 - Vehicle level
 - Active Parking Assist
 - ECO start/stop function
- ⑬ **Start/Stop button**
- ⑭ **Electric parking brake**
- ⑮ **Opens or closes the trunk lid**
- ⑯ **Door control panel with controls for power windows, exterior mirror adjustment and the override feature for the rear side windows**
- ⑰ **Door handle**
 - Locks the vehicle centrally
 - Unlocks the vehicle centrally



Overhead control panel

- ① Buttons for interior lighting and reading light
- ② Button for Mercedes me connect*
- ③ SOS button* (Mercedes-Benz emergency call system)
- ④ Panoramic roof Roller sunblind

* Not available in all countries

Note that your vehicle may not be equipped with all of the features described.

Lever on steering wheel



Overview

- ① Combination switch for turn signal lights, high beam and windshield wipers
- ② Lever for electrical steering column adjustment and steering wheel heater

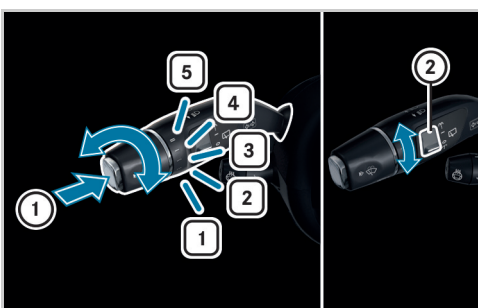

Combination switch – windshield wiper functions

- ① Single wipe
- Wipes with washer fluid
- ① Windshield wipers off
- ② Intermittent wiping, normal
- ③ Intermittent wiping, frequent
- ④ Continuous wiping, slow
- ⑤ Continuous wiping, fast
- ② Operates the rear window wiper

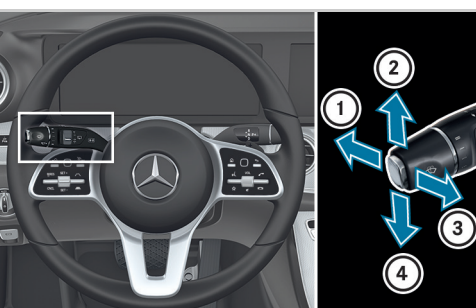

Combination switch – lighting functions

- ① High beam or Adaptive Highbeam Assist Plus
- ② Turn signal light, right
- ③ Headlamp flasher
- ④ Turn signal light, left

⚠ WARNING Make sure that you read the entire Operator's Manual. Otherwise, you may not recognize dangers.

Active Distance Assist DISTRONIC

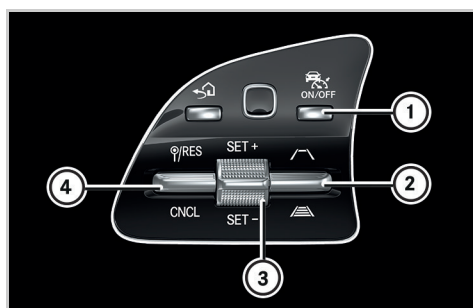

Activating/deactivating

- ① Switches on or off Active Distance Assist DISTRONIC
- ③ Activates Active Distance Assist DISTRONIC with the current speed
- ④ Activates with the stored speed/pulls away with Active Distance Assist DISTRONIC
- Deactivates Active Distance Assist DISTRONIC



Changing the speed

- ② Increases the specified distance
- Reduces the specified distance
- ③ Increases the speed
- Decreases the speed

Active Distance Assist DISTRONIC maintains a constant speed which has been stored. The lowest speed that can be set is 12 mph (20 km/h).

You can change the set speed:

- 1 mph step (1 km/h):** Briefly press rocker switch ③ up or down.
- 5 mph step (10 km/h):** Press rocker switch ③ up or down beyond the pressure point.

Using rocker switch ②, you can change the specified distance to the vehicle in front. The specified distance depends on the currently driven speed.

If rocker switch ④ is pressed upwards twice, Distance Assist DISTRONIC is activated with the speed restriction displayed in the instrument cluster.

Note that your vehicle may not be equipped with all of the features described.

Climate control



Operating possibilities for climate control

You can set automatic climate control using:

- The buttons on control panel ① of the center console
- The air conditioning menu of the multimedia system

Air-conditioning function bar ② shows the most important settings and the status of the automatic climate control system.

Automatic climate control panel

- Sets the temperature
- Sets the air distribution
- Sets the air flow, switches automatic climate control off completely
- Sets climate control to automatic mode
- Defrosts the windshield
- Calls up the air conditioning menu
If you press and hold the **MENU** button for approximately 4 seconds, automatic climate control will be reset to the basic settings.
Residual heat with the engine off
- Defrosts the rear window
- Synchronized operation
- Air-recirculation mode
The air in the interior is recirculated; the windows may fog up more quickly.
- Cooling with air dehumidification

Air conditioning menu of the multimedia system

To call up the air conditioning menu: Press the **MENU** button on the control panel up or down.

- **A/C** – Deactivates the cooling function of automatic climate control
- **Climate Mode** – Changes the air flow
- **Rear** – Operates the automatic climate control in the rear
- **SYNC** – Changes settings for all climate zones in the vehicle simultaneously
- **Air Freshener** – Sets the intensity of the fragrancing system
- **Ionization** – Freshens the air in the interior using ionization



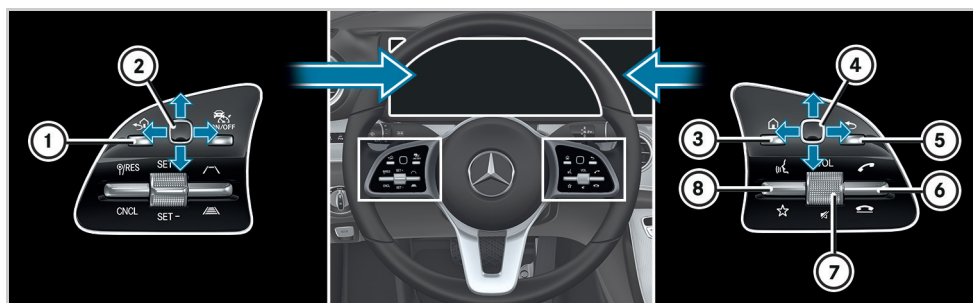

Operating the on-board computer

- ① Back button for the on-board computer
Press and hold: shows the standard display in the on-board computer
- ② Touch Control for the on-board computer
Press: confirms the selection

Telephone/media functions

- ③ Main menu of the multimedia system
- ④ Touch Control for the multimedia system
Press: confirms the selection
- ⑤ Back button for the multimedia system
- ⑥ Accepts a telephone call
 Rejects a telephone call
Ends a call

Operating the Voice Control System

- ⑦ Adjusts the volume
Press: switches the sound on or off
- ⑧ Starts a dialog with the Voice Control System or cancels the current Voice Control System voice command
- Displays favorites

WARNING Make sure that you read the entire Operator's Manual. Otherwise, you may not recognize dangers.

Voice Control System

Starting a dialog

The Voice Control System allows you to comfortably operate the majority of the multimedia system's functions.

To say a voice command: Press the button and say a voice command after the acoustic signal.

i If a mobile phone is connected to the multimedia system of the vehicle via Bluetooth® and you press and hold the button, the mobile phone's voice control feature is activated.

Voice Control System help functions

- **General notes:**
Say the "Help Voice Control System" voice command.
- **Help for the current function:**
Say the "Help" voice command.
- **Help for a specific system:**
Say the voice command for the desired system, e.g. "Help telephone".

Examples

Voice commands for navigation

- "Navigate to Woodward Avenue, Detroit"
Starts route guidance to the named address.
- "Navigate to contact John Doe"
Starts route guidance to a contact in the address book.
- "Nearest gas station"
Further categories are also available: restaurant, parking lot and rest area.

Voice commands for telephone

- "Call Jane Doe"
Calls the number of a contact in the address book.
- "Latest calls"
Shows the latest calls.

Voice commands for audio mode

- "Station Z100"
Calls up stations which are in range or stored stations.
- "Play Moonlight Sonata"
Plays the named media file. All tracks available in the system can be used.

Note that your vehicle may not be equipped with all of the features described.

Overview of the multimedia system

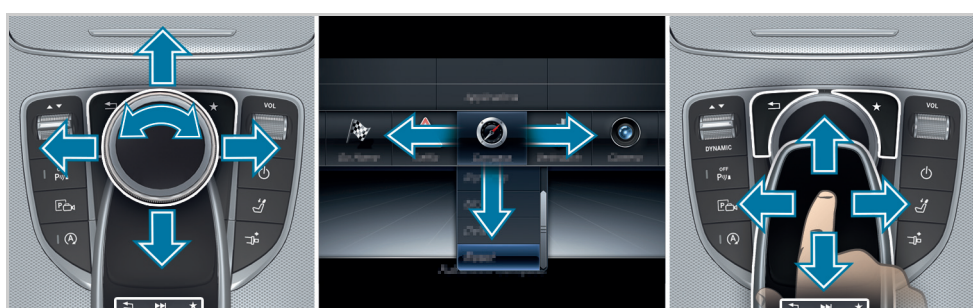

You can operate the menus of the multimedia system using the controller, touchpad or Touch Control.

- ▶ **Controller:** Turn or slide in the direction of the desired entry.
- ▶ Slide to the left or right in order to open a menu.
- ▶ Confirm your choice by pressing the controller.

- ▶ **Touchpad:** Swipe in the direction of the desired entry.
- ▶ Swipe to the left or right in order to open a menu.
- ▶ Confirm your selection by pressing.

- Leaves a menu or switches to the basic menu
- Calls up or changes favorites
- Quick-access to audio sources

Favorites

Favorites allow you to quickly call up applications which you use regularly.

- ▶ **To call up the menu:** Press the button. The main functions are displayed.
- ▶ Navigate downwards. The favorites bar is shown.
- ▶ **To create your own favorite:** Select the desired function in the multimedia system.
- ▶ Press and hold the button until the favorites are displayed.
- ▶ Add your own favorite at the desired position.

Personalization

You can store your own personal settings for the multimedia system in a user profile.

- ▶ **To call up the menu:** Press the button.
- ▶ Select System ▶ Personalization.

WARNING Make sure that you read the entire Operator's Manual. Otherwise, you may not recognize dangers.

Operating the multimedia system

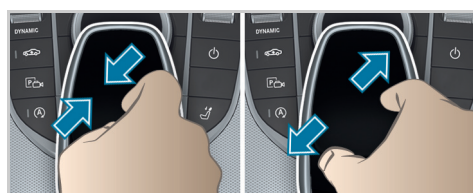

Zoom map

- ▶ **Touchpad:** Move two fingers apart or together.

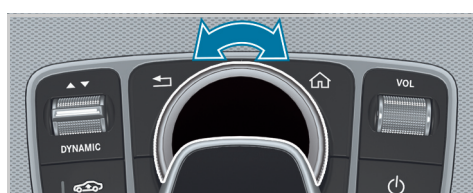

- ▶ **Controller:** Turn left or right.



Quick-access to audio sources

Depending on the audio source to which you are currently listening, you can move to the next radio station or music track.

- ▶ **To open the access bar:** Swipe up with two fingers.
- or
- ▶ Press the button on the touchpad.
- ▶ **To select the previous or next station/music track:** Using a single finger, swipe up or down.
- ▶ **To close the access bar:** Swipe down with two fingers.

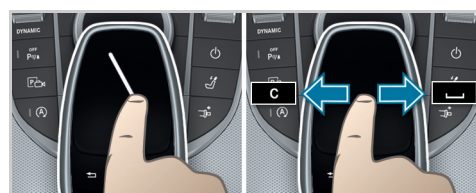

Handwriting recognition

You can enter individual letters.

- ▶ **To delete** : Swipe to the left.
- ▶ **To insert a space** : Swipe to the right.

Quickly storing radio stations

If you are listening to the radio and the Radio menu is shown in the multimedia system:

- ▶ Press and hold the controller/touchpad/right-hand Touch Control of the multifunction steering wheel. An acoustic signal confirms the save.

Note that your vehicle may not be equipped with all of the features described.

Connecting a mobile phone

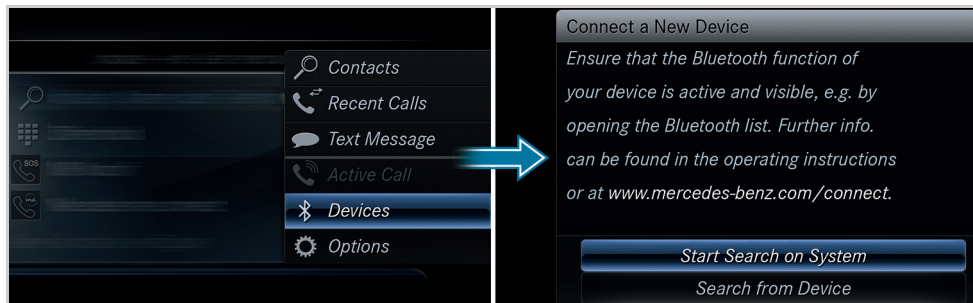

Requirement

- Bluetooth® is switched on on the mobile phone and is visible for other devices (see the manufacturer's operating instructions).
- Bluetooth® is switched on on the multimedia system.

Searching for a mobile phone

- ▶ Press the button on the center console.
 - ▶ Select **Devices** ▶ **Connect New Device**.
 - or
 - ▶ Select **Start Search on System**. The available devices are shown in the display.
- If your mobile phone is not found, select **Search from Device**.

Connecting a mobile phone

- ▶ Select the desired mobile phone. A code is displayed in the multimedia system and on the mobile phone.
- ▶ **If the codes match:** Confirm with **Yes** on the multimedia system.
- ▶ Confirm the code on the mobile phone.
- i** You can simultaneously connect two telephones with your system.

Further information

Detailed information about Bluetooth® connections with your mobile phone can be found at:

www.mercedes-benz.com/connect



WARNING Make sure that you read the entire Operator's Manual. Otherwise, you may not recognize dangers.

Further information on your vehicle

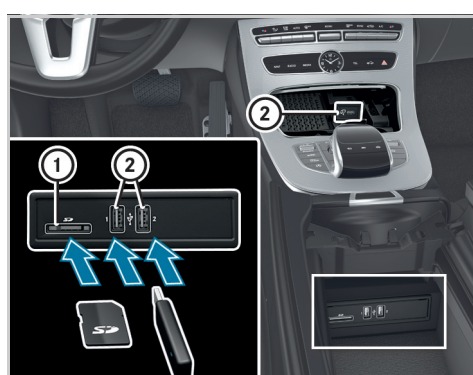

Connecting exterior media sources

- ① SD card slot
- ② USB ports

The USB port for Apple CarPlay™ and Android Auto™ is marked with the symbol.



HANDS-FREE ACCESS

If you carry the KEYLESS-GO key on your person, you will be detected by a sensor. Do not touch the bumper and maintain a distance of around 12 in (30 cm).

- ▶ **To open or close:** Kick into the sensor detection area below the bumper.

Further information on your vehicle

Further information about Mercedes-Benz vehicles and about Daimler AG can be found at the following website:

<http://www.mbusa.com>



How-to videos



Operator's Manuals

Note that your vehicle may not be equipped with all of the features described.