



Digital – in the vehicle

Familiarize yourself with the contents of the Operator's Manual directly via the vehicle's multimedia system (menu item "Vehicle"). Start with the quick guide, discover your vehicle's highlights or broaden your knowledge with useful tips.



Vehicle document wallet

Here you can find comprehensive information about operating your vehicle and about services and warranties in printed form.



Digital – on the Internet

You can find the Operator's Manual on the Mercedes-Benz homepage.



Digital – as an App

The Mercedes-Benz Guides App is available free-of-charge in familiar App stores.

E-Class Wagon



2135843804

Order no. P213 0464 13 Part no. 213 584 38 04
Edition D-2017



Apple® iOS



Android™

Mercedes-Benz

E-Class Wagon

Operator's Manual

Mercedes-Benz





Symbols

In this Operator's Manual, you will find the following symbols:

 **DANGER** Danger due to not observing the warning notices

Warning notices draw your attention to hazards that may endanger your health or life, or the health or life of others.

 Please observe the warning notices in this manual.

 **ENVIRONMENTAL NOTE** Environmental damage due to failure to observe environmental notes

Environmental notes include information on environmentally responsible behavior or environmentally responsible disposal.

 Observe environmental notes.

 **NOTE** Damage to property due to failure to observe notes on material damage

Notes on material damage inform you of risks which may lead to your vehicle being damaged.

 Observe notes on material damage.

 Useful instructions or further information that could be helpful to you.

 Instruction

(→ page) Further information on a topic

Display Information in the multifunction display/multimedia display

 Highest menu level, which is to be selected in the multimedia system

 Corresponding submenus, which are to be selected in the multimedia system

* Indicates a cause

Publication details

Internet

Further information about Mercedes-Benz vehicles and about Daimler AG can be found on the following websites:

<http://www.mbusa.com> (USA only)

<http://www.mercedes-benz.ca> (Canada only)

Editorial office

©Daimler AG: Not to be reprinted, translated or otherwise reproduced, in whole or in part, without written permission from Daimler AG.

Vehicle manufacturer

Daimler AG

Mercedesstrasse 137

70327 Stuttgart

Germany

Welcome to the world of Mercedes-Benz

Before you first drive off, read this Operator's Manual carefully and familiarize yourself with your vehicle. For your own safety and a longer vehicle life, follow the instructions and warning notices in this Operator's Manual. Disregarding them may lead to damage to the vehicle or personal injury.

Vehicle damage resulting from the disregard of the instructions is not covered by the Mercedes-Benz Limited Warranty.

The equipment or model designation of your vehicle may vary according to:

- Model
- Order
- National version
- Availability

Mercedes-Benz reserves the right to introduce changes in the following areas:

- Design
- Equipment
- Technical features

The equipment in your vehicle may therefore differ from that shown in the descriptions and illustrations.

The following are integral parts of the vehicle:

- Digital Operator's Manual
- Printed Operator's Manual
- Maintenance Booklet
- Equipment-dependent supplements

Keep these documents in the vehicle at all times. If you sell the vehicle, always pass all of the documents on to the new owner.

Mercedes-Benz USA, LLC

Mercedes-Benz Canada, Inc.

A Daimler Company

2135843804



At a glance	4	QR code for rescue card	22	Seats	78
Cockpit	4	Vehicle data storage	22	Steering wheel	89
Warning and indicator lamps	6	Copyright	24	Using the memory function	91
Overhead control panel	8			Stowage areas	92
Door control panel and seat adjustment	10	Occupant safety	26	Cup holder	106
Emergencies and breakdowns	12	Restraint system	26	Ashtray and cigarette lighter	107
		Seat belts	28	Sockets	109
		Airbags	32	Wireless charging of the mobile phone and connection with the exterior antenna ...	111
Digital Operator's Manual	14	PRE-SAFE® system	39	Installing/removing floor mats	113
Calling up the Digital Operator's Manual	14	Children in the vehicle	41		
		Pets in the vehicle	50		
				Light and visibility	114
General notes	15	Opening and closing	51	Exterior lighting	114
Protecting the environment	15	SmartKey	51	Interior lighting	118
Mercedes-Benz GenuineParts	15	Doors	56	Windshield wiper and windshield washer system	119
Operator's Manual	16	Load compartment	59	Mirrors	123
Service and vehicle operation	17	Roller sun blinds	65	Operating the sun visors	125
Operating safety	18	Side windows	66	Infrared reflective windshield	126
Declaration of conformity for wireless vehicle components	19	Sliding sunroof	70		
Diagnostics connection	20	Anti-theft protection	75		
Qualified specialist workshop	21			Climate control	127
Correct use of the vehicle	21	Seats and stowing	77	Overview of climate control systems	127
Problems with your vehicle	21	Correct driver's seat position	77	Operating the climate control system	128
Reporting safety defects	21				
Limited Warranty	22				

Driving and parking	133
Driving	133
DYNAMIC SELECT switch	140
Automatic transmission	141
Refueling	145
Parking	147
Driving and driving safety systems	154

Instrument Display and on-board computer	199
Instrument Display overview	199
Overview of the buttons on the steering wheel	200
Operating the on-board computer	200
Displays in the multifunction display	201
Adjusting the instrument lighting	202
Menus and submenus	202
Head-up Display	208

Multimedia system	210
Overview and operation	210
System settings	218
Garmin® MAP PILOT navigation module	223

Telephone	224
Online and Internet functions	234
Media	237
Radio	243
Sound	248

Maintenance and care	250
ASSYST PLUS service interval display	250
Engine compartment	251
Cleaning and care	257

Breakdown assistance	264
Emergency	264
Flat tire	264
Battery (vehicle)	270
Tow starting or towing away	275
Electrical fuses	280

Wheels and tires	284
Noise or unusual handling characteristics	284
Regular checking of wheels and tires	284
Notes on snow chains	285

Tire pressure	285
Loading the vehicle	291
Tire labeling	296
Definitions for tires and loading	301
Changing a wheel	304

Technical data	314
Notes on technical data	314
Vehicle electronics	314
Vehicle identification plate, VIN and engine number	316
Operating fluids	318
Vehicle data	324

Display messages and warning/indicator lamps	326
Display messages	326
Warning and indicator lamps	368



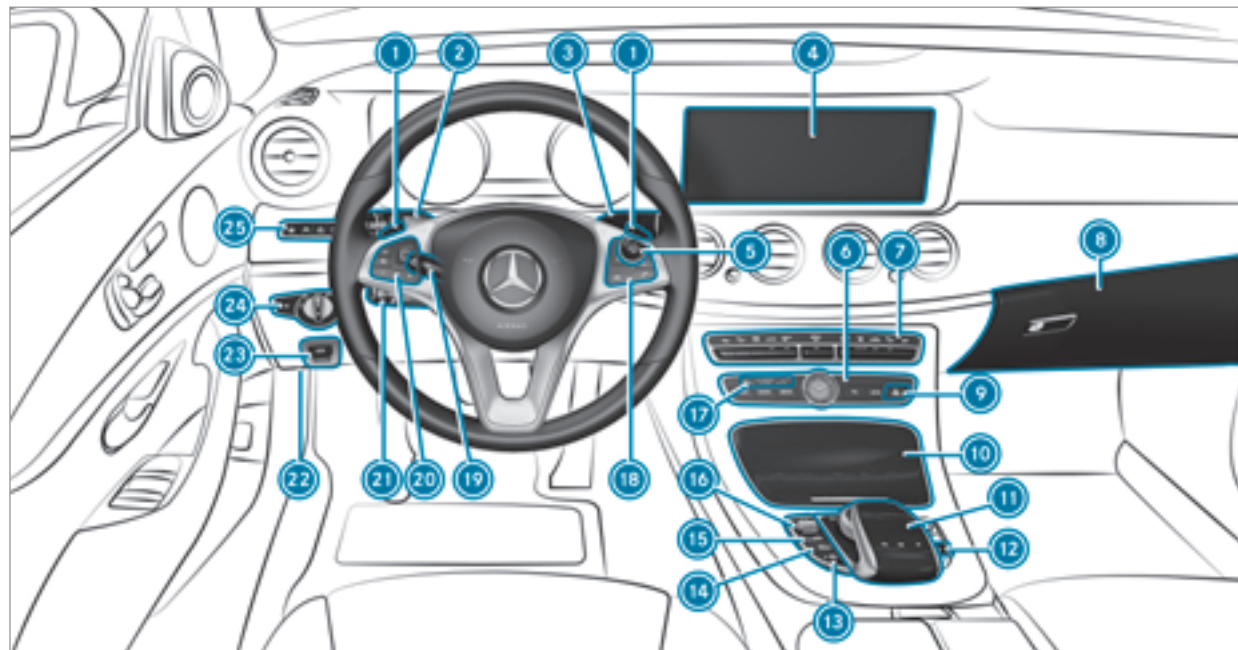



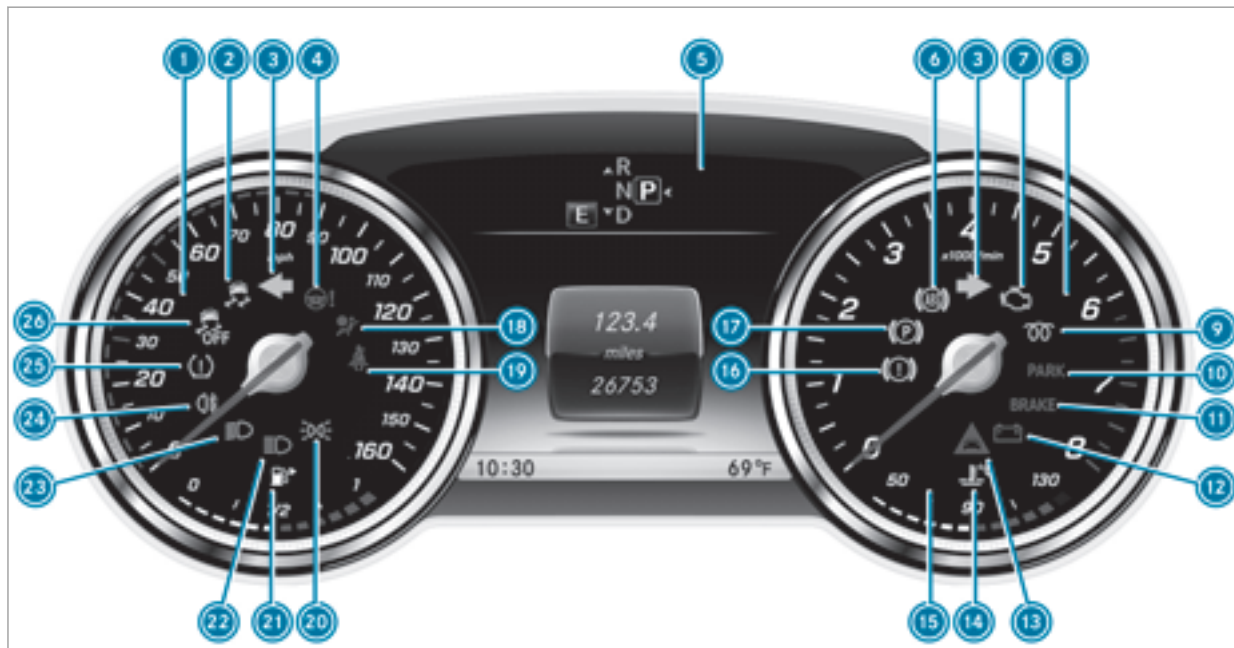



















Index	386
--------------------	------------









①	Steering wheel gearshift paddle	→	143	⑩	Stowage compartment	→	94
②	Combination switch	→	115	⑪	Controls for the multimedia system	→	210
③	DIRECT SELECT lever	→	141	⑫	To lower the rear head restraint	→	84
④	Display (multimedia system)	→	210	⑬	ECO start/stop function	→	139
⑤	Start/Stop button	→	134	⑭	Parking Pilot	→	188
⑥	Control panel for multimedia system	→	210	⑮	To set the vehicle level	→	176
⑦	Climate control systems	→	128	⑯	DYNAMIC SELECT switch	→	140
⑧	Glove box	→	94	⑰	PASSENGER AIRBAG indicator lamp	→	, 37
⑨	Hazard warning lights	→	116	⑱	Control panel for multimedia system	→	200
				⑲	To adjust the steering wheel	→	90
				⑳	Control panel for on-board computer	→	200
				㉑	Cruise control lever	→	164
				㉒	To unlock the hood	→	251
				㉓	Electric parking brake	→	151
				㉔	Light switch	→	114
				㉕	Control panel for:		
					Steering Pilot	→	173
					Active Lane Keeping Assist	→	197
					Parking Assist PARKTRONIC	→	180
					Head-up Display	→	209

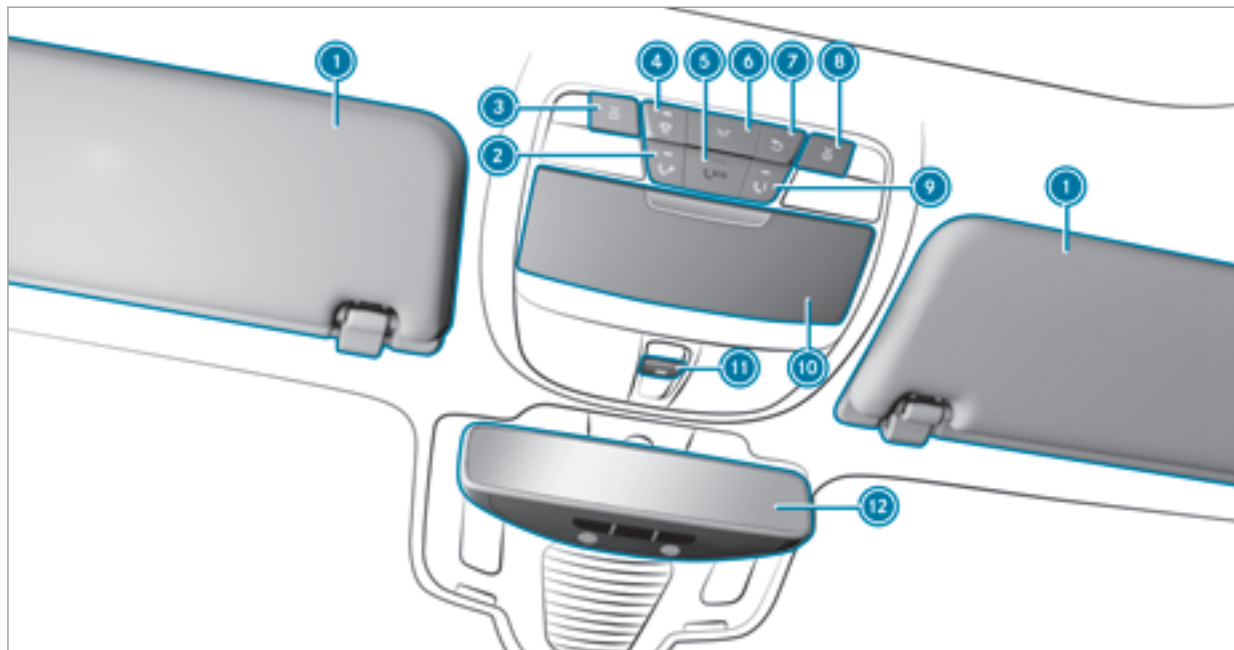





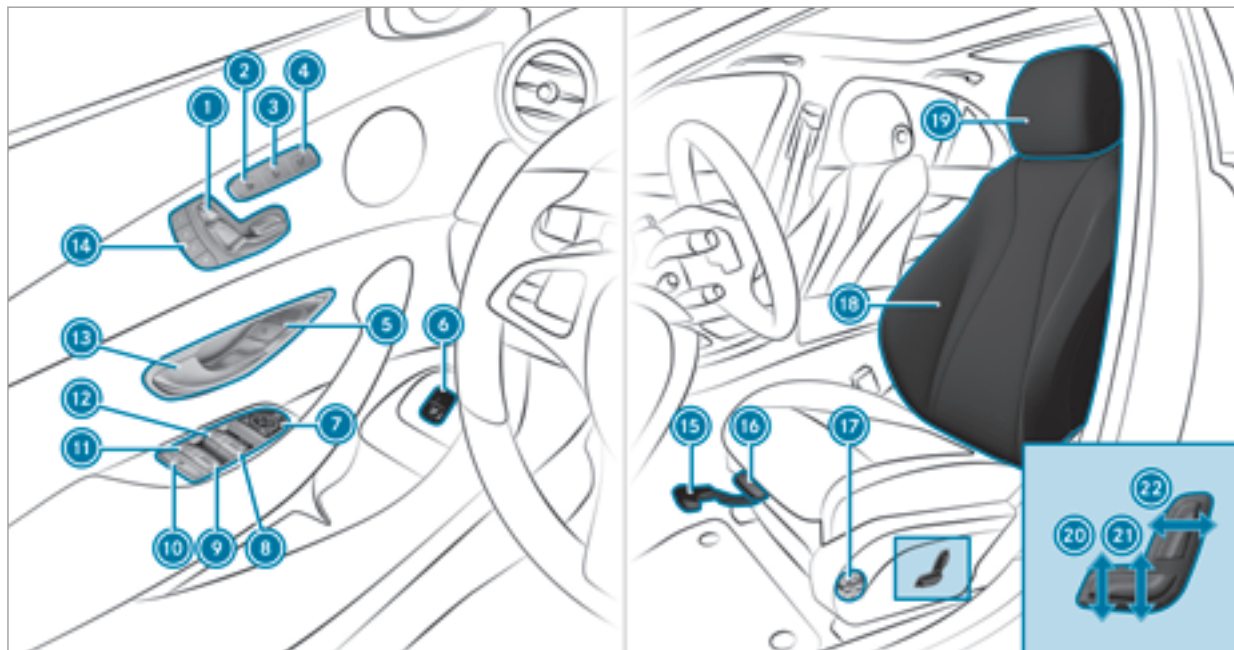

Instrument Display

1	 Speedometer	→	199
2	 ESP®		
3	  Turn signal light	→	115
4	 Steering assistance malfunction		
5	Multifunction display	→	201
6	 ABS malfunction		
7	 Check Engine		
8	Tachometer	→	199
9	 This indicator lamp has no function		
10	Electric parking brake applied (red)		
	 USA only		
	 Canada only		
11	Brakes (red)		
	 USA only		
	 Canada only		
12	 Electrical malfunction		
13	 Distance warning		
14	 Coolant too hot/cold		
15	Coolant temperature gauge	→	199
16	 Brakes (yellow)		
17	 Electric parking brake (yellow)		
18	 Restraint system	→	27
19	 Seat belt is not fastened		
20	 Parking lights	→	114
21	Fuel level indicator		
	 Fuel reserve with fuel filler flap location indicator		
22	 High beam	→	115
23	 Low beam	→	114
24	 Rear fog light	→	115
25	 Tire pressure monitoring system		
26	 ESP® OFF		



①	Sun visors	→	125	⑧	 Switches the right-hand reading lamp on/off	→	118
②	Roadside Assistance call button (mbrace®)	→	233	⑨	MB Info call button (mbrace®)	→	233
③	 Switches the left-hand reading lamp on/off	→	118	⑩	Eyeglasses box	→	94
④	 Switches the automatic lighting control on/off	→	118	⑪	 Opens/closes the panoramic sliding sun-roof	→	70
⑤	SOS button (mbrace®)	→	232		Opens/closes the roller sun blinds	→	70
⑥	 Switches the front interior lighting on/off	→	118	⑫	Inside mirror	→	124
⑦	 Switches the rear interior lighting on/off	→	118				



①	Adjusts the seats electrically	→	81	⑫	 Opens/closes the left side window	→	66
②	Switches the seat heater on/off	→	84	⑬	Opens the door	→	56
③	Switches the seat ventilation on/off	→	85	⑭	Sets the memory function	→	91
④	Adjusts the front passenger seat from the driver's seat	→	81	⑮	Sets the seat fore-and-aft adjustment	→	80
⑤	  Locks/unlocks the vehicle	→	56	⑯	Adjusts the seat cushion length	→	80
⑥	Opens/closes the tailgate	→	59	⑰	Adjusts the 4-way lumbar support	→	82
⑦	Adjusts and folds the outside mirrors out/in electrically	→	123	⑱	Seat adjustment using the multimedia system		
⑧	 Opens/closes the right side window	→	66	⑲	Adjusts the head restraints	→	82
⑨	 Opens/closes the rear right side window	→	66	⑳	Adjusts the seat cushion inclination	→	80
⑩	Child safety lock for the rear side windows	→	49	㉑	Adjusts the seat height	→	80
⑪	 Opens/closes the rear left side window	→	66	㉒	Adjusts the seat backrest inclination	→	80

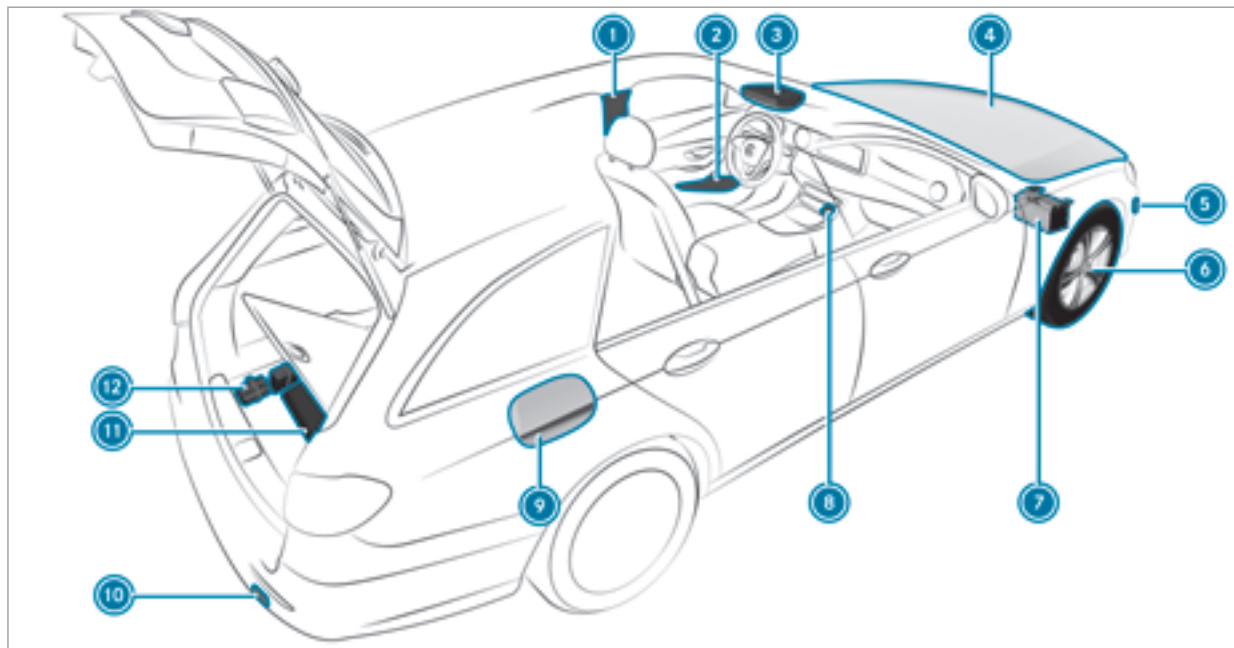

What to do in the event of an accident	→		7 Starting assistance	→	272
1 QR code for accessing the rescue card	→	22	8 Hazard warning lights	→	116
2 Safety vests	→	264	9 Fuel filler flap with instruction labels for tire pressure, fuel type and QR code for accessing the rescue card	→	145
3 Button for the SOS emergency call system and breakdown assistance	→	231	10 Tow-starting and towing away	→	276
4 Checking and topping up operating fluids	→	318	11 Tire-change tool kit	→	307
5 Tow-starting and towing away	→	276	12 TIREFIT kit	→	266
6 Flat tire	→	264			

Calling up the Digital Operator's Manual

Multimedia system:

↳ Vehicle ▶ Operator's Manual

▶ Select a menu item.

The Digital Operator's Manual describes the function and operation of:



- the vehicle
- the multimedia system



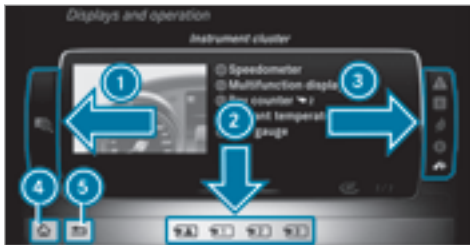

For safety reasons, the Digital Operator's Manual is deactivated while driving.

The Digital Operator's Manual contains the following menu items:

- **Search:** allows you to search precisely for keywords.
- **Quick start:** provides you with important information so that you can start using your vehicle immediately.
- **Tips:** provides tips on how to use your vehicle in certain situations.
- **Bookmarks:** provides you with a list of all the bookmarks you have stored yourself.



- ▶ **To scroll forwards/backwards:** turn the controller.
- ▶ **To display in full screen:** navigate to the left ①.
- ▶ **To select a note or store a bookmark:** navigate to the right ③.
- ▶ **To select a link:** navigate down ②.
- ▶ **To exit a content page:** select the  symbol ⑤.
- ▶ **To call up the basic menu of the Digital Operator's Manual:** select  symbol ④.

▶ **To switch functions to the multimedia system using the buttons on the center console:** press the , ,  or  button.

The selected menu appears. The Digital Operator's Manual remains open in the background.

① The Operator's Manual can also be found in the Mercedes-Benz Guides app in all common app stores.

Protecting the environment



ENVIRONMENTAL NOTE Environmental damage due to operating conditions and personal driving style

The pollutant emission of your vehicle is directly related to the way you operate your vehicle.

You can help to protect the environment by operating your vehicle in an environmentally-responsible manner. Please observe the following recommendations on operating conditions and personal driving style.

Operating conditions:

- ▶ Make sure that the tire pressure is correct.
- ▶ Do not carry any unnecessary weight (e.g. roof luggage racks once you no longer need them).
- ▶ Adhere to the service intervals.
A regularly serviced vehicle will contribute to environmental protection.

- ▶ Always have service work carried out at a qualified specialist workshop.

Personal driving style:

- ▶ Do not depress the accelerator pedal when starting the engine.
- ▶ Do not warm up the engine while the vehicle is stationary.
- ▶ Drive carefully and maintain a suitable distance from the vehicle in front.
- ▶ Avoid frequent, sudden acceleration and braking.
- ▶ Change gear in good time and use each gear only up to $\frac{2}{3}$ of its maximum engine speed.
- ▶ Switch off the engine in stationary traffic.
- ▶ Keep an eye on the vehicle's fuel consumption.

Environmental issues and recommendations:

It is recommended that you re-use or recycle materials first instead of just disposing of them.

The relevant environmental regulations and guidelines serve to protect the environment and must be strictly observed.

Mercedes-Benz GenuineParts



ENVIRONMENTAL NOTE Environmental damage caused by the non-use of reconditioned components.

Daimler AG offers recycled reconditioned components and parts with the same quality as new parts. The same entitlement from the limited warranty is valid as for new parts.

- ▶ Use recycled reconditioned components and parts from Daimler AG.

! **NOTE** Impairment of the operating efficiency of the restraint systems from installing accessories or from repairs or welding

Airbags, Emergency Tensioning Devices, as well as control units and sensors for the restraint systems, may be installed in the following areas of your vehicle:

- Doors
 - Door pillars
 - Door sills
 - Seats
 - Cockpit
 - Instrument cluster
 - Center console
- ▶ Do not install accessories such as audio systems in these areas.
- ▶ Do not carry out repairs or welding.
- ▶ Have accessories retrofitted at a qualified specialist workshop.

You could jeopardize the operating safety of your vehicle if you use parts, tires and wheels as well as accessories relevant to safety which have not been approved by Mercedes-Benz. This could lead to malfunctions in safety-relevant systems, for example, the brake system. Only use Mercedes-Benz GenuineParts or parts of equal quality. Only use tires, wheels and accessory parts that have been specifically approved for your vehicle model.

Mercedes-Benz GenuineParts are subject to strict quality control. Each part has been specially developed, manufactured or selected for Mercedes-Benz vehicles and fine-tuned for them. Therefore, only Mercedes-Benz GenuineParts should be used.

More than 300,000 different Mercedes-Benz GenuineParts are available for Mercedes-Benz models.

All authorized Mercedes-Benz Centers maintain a supply of Mercedes-Benz GenuineParts for necessary service and repair work. In addition, strategically located parts-delivery centers provide for quick and reliable parts service.

Always specify the vehicle identification number (VIN) (→ page 316) when ordering Mercedes-Benz GenuineParts.

Operator's Manual

This Operator's Manual describes all models and all standard and optional equipment available for your vehicle at the time of this Operator's Manual going to press. Country-specific differences are possible. Note that your vehicle may not be equipped with all features described. This is also the case for systems and functions relevant to safety. Therefore, the equipment on your vehicle may differ from that in the descriptions and illustrations.

The original purchase contract documentation for your vehicle contains a list of all of the systems in your vehicle.

Should you have any questions concerning equipment and operation, please consult an authorized Mercedes-Benz service center.

The Operator's Manual and maintenance booklet are important documents and should be kept in the vehicle.

Service and vehicle operation

Vehicle operation outside the USA or Canada

When you are abroad with your vehicle, observe the following points:

- Service points or replacement parts may not be available immediately.
- Unleaded fuel may not be available for vehicles with a catalytic converter. Leaded fuel may cause damage to the catalytic converter.
- The fuel may have an extremely low octane number. Unsuitable fuel can cause engine damage.

Some Mercedes-Benz models are available in Europe through our European Delivery Program. For more information, please consult an authorized Mercedes-Benz service center, or write to one of the following address:

In the USA:

Mercedes-Benz USA, LLC
European Delivery Department
One Mercedes Drive
Montvale, NJ 07645-0350

In Canada:

Mercedes-Benz Canada, Inc.
European Delivery Department
98 Vanderhoof Avenue
Toronto, Ontario M4G 4C9

Maintenance

Your customer advisor confirms the service in the service report.

Roadside Assistance

The Mercedes-Benz Roadside Assistance Program offers technical help in the case of a breakdown. Your calls to the toll-free Roadside Assistance Hotline are answered by our agents 24 hours a day, 365 days a year.

1-800-FOR-MERCEdes (1-800-367-6372) (USA)
1-800-387-0100 (Canada)

You can find further information in the Mercedes-Benz Roadside Assistance Program brochure (USA) or the "Roadside Assistance"

section in the maintenance and warranty information booklet (Canada). You will find both in the vehicle document wallet.

Change of address or change of ownership

In the event of a change of address, please send us the "Notification of address change" in the Service and Guarantee booklet or simply call the Mercedes-Benz Customer Assistance Center (USA) on the hotline number 1-800-FOR-MERCEdes (1-800-367-6372) or Customer Service (Canada) on 1-800-387-0100. We can then reach you in a timely fashion, if necessary.

If you sell your Mercedes, please leave all literature in the vehicle so that it is available to the next owner. If you have purchased a used vehicle, please send us the "Notice of Purchase of Used Car" in the Service and Guarantee booklet or simply call the Mercedes-Benz Customer Assistance Center (USA) at the hotline number 1-800-FOR-MERCEdes (1-800-367-6372) or Customer Service (Canada) at 1-800-387-0100.

Important notice for California retail buyers and lessees of Mercedes-Benz automobiles

Under California law you may be entitled to a replacement of your vehicle or a refund of the purchase price or lease price, if after a reasonable number of repair attempts Mercedes-Benz USA, LLC and/or its authorized repair or service facilities fail to fix one or more substantial defects or malfunctions in the vehicle that are covered by its express warranty.

During a period of 18 months from original delivery of the vehicle or a kilometer/mileage reading of 18,000 miles (29,000 km), whichever occurs first, vehicle repair is presumed for a retail buyer or lessee if one or more of the following occurs:

- (1) the serious defect or damage can result in deadly or serious injury to the vehicle occupants while driving AND this defect has already been repaired at least twice AND Mercedes-Benz, LLC has been informed in writing of the necessity of a repair.
- (2) the defect or damage, though less serious than (1) above, has already been repaired at

least four times AND Mercedes-Benz has been informed in writing of the necessity of a repair.

- (3) the vehicle cannot be used for longer than 30 calendar days because of repair work resulting from this or other serious defects or damage.

Please send your written notice to:

Mercedes-Benz USA, LLC
Customer Assistance Center
3 Mercedes Drive
Montvale, NJ 07645-0350

Operating safety

⚠ WARNING Risk of accident due to malfunctions or system failures

If you do not have the prescribed service/maintenance work or any required repairs carried out, this could result in malfunctions or system failures.

- ▶ Always have the prescribed service/maintenance work as well any required repairs carried out at a qualified specialist workshop.

⚠ WARNING Risk of fire due to flammable materials on hot parts of the exhaust system

Flammable material such as leaves, grass or twigs may ignite if they come into contact with hot parts of the exhaust system.

- ▶ When driving on unpaved roads or off-road, regularly check the vehicle underside.
- ▶ Remove trapped plants or other flammable material, in particular.
- ▶ If there is damage, consult a qualified specialist workshop immediately.

⚠ WARNING Risk of accident or injury due to incorrect modifications on electronic component parts

Modification to electronic components, their software or wiring could impair their function and/or the function of other networked component parts. In particular, systems relevant to safety could also be affected.

As a result, these may no longer function properly and/or jeopardize the operating safety of the vehicle.

- ▶ Never tamper with the wiring and electronic component parts or their software.
- ▶ You should have all work on electrical and electronic components carried out at a qualified specialist workshop.

! NOTE Damage to the vehicle

Damage to the vehicle may occur in the following cases:

- The vehicle becomes grounded, e.g. on a high curb or an unpaved road.
- The vehicle is driven too fast over an obstacle, e.g. a curb, speed bump or pothole.
- A heavy object strikes the underbody or parts of the chassis.

In situations such as this, the body, the underbody, chassis parts, wheels or tires could be damaged without the damage being visible. Components damaged in this way can unexpectedly fail or, in the case of an accident, no longer withstand the strain they are designed to.

If the underbody paneling is damaged, flammable materials such as leaves, grass or twigs can gather between the underbody and the underbody paneling. If these materials come into contact with hot parts on the exhaust system, they may catch fire.

- ▶ Have the vehicle checked and repaired immediately at a qualified specialist workshop.

or

- ▶ If driving safety is impaired while continuing your journey, pull over and stop the vehicle immediately, paying attention to road and traffic conditions, and contact a qualified specialist workshop.

Declaration of conformity for wireless vehicle components

USA: "The wireless devices of this vehicle comply with Part 15 of the FCC Rules. Operation is subject to the following two conditions: 1) These devices may not cause harmful interference, and 2) These devices must accept any interference received, including interference that may cause undesired operation. Changes or modifications not expressly approved by the party responsible for compliance could void the user's authority to operate the equipment."

Canada: "The wireless devices of this vehicle comply with Industry Canada license-exempt RSS standard(s). Operation is subject to the following two conditions: (1) These devices may not cause interference, and (2) These devices must accept any interference, including interference that may cause undesired operation of the device."

USA: "Wireless charging system for mobile devices (Model: D-WMI2015A): This Device complies with Part 18 of the FCC Rules."

The name and address of the responsible party is:

Continental Automotive Systems US Inc.
2400 Executive Hills Drive
Auburn Hills, MI 48326-2980
United States of America

Diagnosics connection

The diagnostics connection is only intended for the connection of diagnostic devices at a qualified specialist workshop.

⚠ WARNING Risk of accident due to connecting devices to the diagnostics connection

If you connect equipment to a diagnostics connection in the vehicle, it may affect the operation of vehicle systems.

As a result, the operating safety of the vehicle could be affected.

- ▶ Only connect equipment to a diagnostics connection in the vehicle which is approved for your vehicle by Mercedes-Benz.

⚠ WARNING Risk of accident due to objects in the driver's footwell

Objects in the driver's footwell may impede pedal travel or block a depressed pedal.

This jeopardizes the operating and road safety of the vehicle.

- ▶ Stow all objects in the vehicle securely so that they cannot get into the driver's footwell.

- ▶ Always install the floor mats securely and as prescribed in order to ensure that there is always sufficient room for the pedals.
- ▶ Do not use loose floor mats and do not place floor mats on top of one another.

! NOTE Battery discharging from using devices connected to the diagnostics connection

Using devices at the diagnostics connection drains the battery.

- ▶ Check the charge level of the battery.
- ▶ If the charge level is low, charge the battery, e.g. by driving a considerable distance.

Connecting equipment to the diagnostics connection can lead to emissions monitoring information being reset, for example. This may lead to the vehicle failing to meet the requirements of the next emissions inspection during the main inspection.

Qualified specialist workshop

An authorized Mercedes-Benz Center is a qualified specialist workshop. It has the necessary specialist knowledge, tools and qualifications to correctly carry out the work required on your vehicle. This particularly applies to work relevant to safety.

For the following, always have your vehicle checked at an authorized Mercedes-Benz Center:

- Work relevant to safety
- Service and maintenance work
- Repair work
- Modifications, installations and conversions
- Work on electronic component parts

Correct use of the vehicle

If you remove any warning stickers, you or others could fail to recognize certain dangers. Leave warning stickers in position.

Observe the following information when driving your vehicle:

- the safety notes in this manual
- the vehicle technical data
- traffic rules and regulations
- laws and safety standards pertaining to motor vehicles

Problems with your vehicle

If you should experience a problem with your vehicle, particularly one that you believe may affect its safe operation, we urge you to contact an authorized Mercedes-Benz service center immediately to have the problem diagnosed and rectified. If the problem is not resolved to your satisfaction, please discuss the problem again with the authorized Mercedes-Benz service center or, if necessary, contact us at one of the following addresses.

In the USA:

Customer Assistance Center
Mercedes-Benz USA, LLC

3 Mercedes Drive
Montvale, NJ 07645-0350

In Canada:

Customer Relations Department
Mercedes-Benz Canada, Inc.
98 Vanderhoof Avenue
Toronto, Ontario M4G 4C9

Reporting safety defects

USA only:

The following text is published as required of manufacturers under Title 49, Code of U.S. Federal Regulations, Part 575 pursuant to the "National Traffic and Motor Vehicle Safety Act of 1966".

If you believe that your vehicle has a defect which could cause a crash or could cause injury or death, you should immediately inform the National Highway Traffic Safety Administration (NHTSA) in addition to notifying Mercedes-Benz USA, LLC.

If NHTSA receives similar complaints, it may open an investigation, and if it finds that a safety defect exists in a group of vehicles, it may order a recall and remedy campaign. However, NHTSA cannot become involved in individual problems between you, your dealer, or Mercedes-Benz USA, LLC.

To contact NHTSA, you may call the Vehicle Safety Hotline toll-free at 1-888-327-4236 (TTY: 1-800-424-9153) (inside the USA); go to <http://www.safercar.gov>; or write to: Administrator, NHTSA, 400 Seventh Street, SW., Washington, DC 20590, USA.

Further information on vehicle safety can be found at: <http://www.safercar.gov>

Limited Warranty

! **NOTE** Damage to the vehicle arising from culpable violation of these operating instructions.

Damage to the vehicle can arise from culpable violation of these operating instructions.

This damage is not covered either by the Mercedes-Benz Limited Warranty or by the New Vehicle or Used Vehicle Warranty.

▶ Follow the instructions in this manual on proper operation of your vehicle as well as on possible vehicle damage.

QR code for rescue card

The QR code is secured in the fuel filler flap and on the opposite side on the B-pillar. In the event of an accident, rescue services can use the QR code to quickly find the appropriate rescue card for your vehicle. The current rescue card contains the most important information about your vehicle in a compact form, e.g. the routing of the electric lines.

Further information can be obtained at <http://www.mercedes-benz.de/qr-code>.

Vehicle data storage

Data acquisition

A wide range of electronic components in your vehicle contain data memories.

These data memories temporarily or permanently store technical information about:

- The vehicle's operating state
- Events
- Malfunctions

In general, the technical information documents the state of a component part, a module, a system or the surroundings.

These include, for example:

- Operating conditions of system components. For example, fluid levels.
- The vehicle's status messages and those of its individual components. For example, the number of wheel revolutions/speed, deceleration, lateral acceleration, accelerator pedal position.

- Malfunctions and defects in important system components. For example, lights, brakes.
- Vehicle reactions and operating conditions in special driving situations. For example, air bag deployment, intervention of stability control systems.
- Ambient conditions. For example, outside temperature.

This data is of an exclusively technical nature and can be used to:

- Assist in detecting and rectifying malfunctions and defects.
- Analyze vehicle functions, e.g. after an accident.
- Optimize vehicle functions.

The data cannot be used to trace the vehicle's movements.

When your vehicle is serviced, technical information can be read from the event data memory and malfunction data memory.

Services include, for example:

- Repair services
- Service processes
- Warranty cases

The vehicle is read out by employees of the service network (including the manufacturer) using special diagnostic devices. You can obtain more information there, if required.

After a malfunction has been rectified, the information is deleted from the malfunction memory or is continually overwritten.

When operating the vehicle, situations are conceivable in which this technical data, in connection with other information (if necessary, after consultation with an authorized expert), could be traced to a person.

Examples include:

- Accident reports
- Damage to the vehicle
- Witness statements

Further additional functions that have been contractually agreed upon with the customer allow

certain vehicle data to be conveyed by the vehicle as well. The additional functions include, for example, vehicle location in case of an emergency.

COMAND/mbrace

If the vehicle is equipped with COMAND or mbrace, additional data about the vehicle's operation, the use of the vehicle in certain situations, and the location of the vehicle may be compiled through COMAND or the mbrace system.

Additional information can be found in the multimedia system section and/or the mbrace Terms and Conditions.

Event data recorders

This vehicle is equipped with an event data recorder (EDR). The main purpose of an EDR is to record, in certain crash or near crash-like situations, such as an air bag deployment or hitting a road obstacle, data which will assist in understanding how a vehicle's systems performed. The EDR is designed to record data related to vehicle dynamics and safety systems for a short period of time, typically 30 seconds or less.

The EDR in this vehicle is designed to record such data as:

- How various systems in your vehicle were operating;
- Whether or not the driver and passenger safety belts were buckled/fastened;
- How far (if at all) the driver was depressing the accelerator and/or brake pedal; and,
- How fast the vehicle was traveling.

This data can help provide a better understanding of the circumstances in which accidents and injuries occur. NOTE: EDR data is recorded by your vehicle only if a non-trivial crash situation occurs; no data is recorded by the EDR under normal driving conditions and no personal data (e.g. name, gender, age and accident location) is recorded. However, other parties, such as law enforcement, could combine EDR data with the type of personally identifying data routinely acquired during a crash investigation.

Access to the vehicle and/or the EDR is needed to read data that is recorded by the EDR, and special equipment is required. In addition to the vehicle manufacturer, other parties that have the

special equipment, such as law enforcement, can read the information by accessing the vehicle or the EDR.

EDR data may be used in civil and criminal matters as a tool in accident reconstruction, accident claims and vehicle safety. Since the Crash Data Retrieval (CDR) tool that is used to extract data from the EDR is commercially available, Mercedes-Benz USA, LLC ("MBUSA") expressly disclaims any and all liability arising from the extraction of this information by unauthorized Mercedes-Benz personnel.

MBUSA will not share EDR data with others without the consent of the vehicle owner or, if the vehicle is leased, without the consent of the lessee. Exceptions to this representation include responses to subpoenas by law enforcement; by federal, state or local government; in connection with or arising out of litigation involving MBUSA or its subsidiaries and affiliates; or, as required by law.

Warning: the EDR is a component of the Restraint System Module. Tampering with, altering, modifying or removing the EDR component

may result in a malfunction of the Restraint System Module and other systems.

State laws or regulations regarding EDRs that conflict with federal regulation are pre-empted. This means that in the event of such conflict, the federal regulation governs. As of February 2013, 13 states have enacted laws relating to EDRs.

Copyright

Free and open source software

Information on free and open source software licenses for your vehicle's software can be found on the data storage medium in your vehicle document wallet and on the Internet together with updates at:

<http://www.mercedes-benz.com/opensource>

Registered trademarks

- Bluetooth® is a registered trademark of Bluetooth SIG Inc.
- DTS™ is a registered trademark of DTS, Inc.

- Dolby® and MLP™ are registered trademarks of DOLBY Laboratories.
- BabySmart™, ESP® and PRE-SAFE® are registered trademarks of Daimler AG.
- HomeLink® is a registered trademark of Johnson Controls.
- iPod® and iTunes® are registered trademarks of Apple Inc.
- Burmester® is a registered trademark of Burmester Audiosysteme GmbH.
- Microsoft® and Windows Media® are registered trademarks of Microsoft Corporation.
- SIRIUS® is a registered trademark of Sirius XM Radio Inc.
- HD Radio™ is a registered trademark of iBiquity Digital Corporation.
- Gracenote® is a registered trademark of Gracenote, Inc.
- ZAGATSurvey® and related brands are registered trademarks of ZagatSurvey, LLC.

Restraint system

Protection by the restraint system

The restraint system includes the following:

- Seat belt system
- Air bags
- Child restraint system
- Child seat securing system

In the event of an accident, the restraint system can:

- Reduce the risk of vehicle occupants coming into contact with parts of the vehicle interior.
- Reduce the forces to which the vehicle occupants are subjected.

A seat belt can only provide the best level of protection if it is worn correctly. Depending on the detected accident situation, Emergency Tensioning Devices and/or air bags supplement the protection offered by a correctly worn seat belt. Emergency Tensioning Devices and/or air bags are not deployed in every accident.

In order for the restraint system to provide protection, each vehicle occupant must:

- Have their seat belt fastened correctly.
- Sit in an almost upright seat position with their back against the seat backrest.
- Sit with their feet resting on the floor, if possible.
- Always be secured in an additional restraint system suitable for Mercedes-Benz vehicles if they are under 5 ft (1.50 m) tall.

However, no system available today can completely eliminate injuries and fatalities in every accident situation. In particular, the seat belt and air bag generally do not protect against objects penetrating the vehicle from the outside. It is also not possible to completely rule out the risk of injury caused by the air bag deploying.

Reduced restraint system protection

⚠ WARNING Risk of injury or death from modifications to the restraint system

The restraint system can no longer function correctly after alterations have been made.

The restraint system may then not protect the vehicle occupants as intended by failing in an accident or triggering unexpectedly, for example



- ▶ Never alter the parts of the restraint system.
- ▶ Never tamper with the wiring or any electronic component parts or their software.

- If it is necessary to modify the vehicle to accommodate a person with disabilities, contact an authorized Mercedes-Benz Center for details.
- USA only: for details, contact our Customer Assistance Center on 1-800-FOR-MERCEdes (1-800-367-6372).

Restraint system functionality

When the ignition is switched on, a system self-test is performed, during which the  restraint system warning lamp lights up. It goes out no later than a few seconds after the vehicle is started. The components of the restraint system are then functional.

Restraint system malfunction

- The  restraint system warning lamp does not light up when the ignition is switched on.
- The  restraint system warning lamp lights up continuously or repeatedly during a journey.

⚠ WARNING Risk of injury or fatal injury due to a malfunction in the restraint system

If the restraint system is malfunctioning, restraint system components may be triggered unintentionally or might not be triggered at all in the event of an accident. This

may affect the Emergency Tensioning Device or airbag, for example.

- ▶ Have the restraint system checked and repaired immediately at a qualified specialist workshop.

Function of the restraint system in an accident

How the restraint system works is determined by the severity of the impact detected and the type of accident anticipated:

- Frontal impact
- Rear impact
- Side impact
- Rollover

The activation thresholds for the components of the restraint system are determined based on the evaluation of the sensor values measured at various points in the vehicle. This process is preemptive in nature. The triggering/deployment of the components of the restraint system must take place right at the start of the collision.

Factors which can only be seen and measured after a collision has occurred cannot constitute a reason for an air bag deployment. Neither do they provide an indication of air bag deployment.

The vehicle may be deformed significantly without an air bag being deployed. This is the case if only parts which are relatively easily deformed are affected and the rate of vehicle deceleration is not high. Conversely, an air bag may have been deployed even though the vehicle only suffered minor deformation. If very rigid vehicle parts such as longitudinal members are hit, for example, this may result in sufficiently high levels of vehicle deceleration.

The components of the restraint system can be activated or deployed independently of each other:

Component	Detected deployment situation
Emergency Tensioning Devices	Frontal impact, rear impact, side impact, rollover
Driver's air bag, front passenger air bag	Frontal impact
Knee air bag	Frontal impact
Side air bag	Side impact
Window air bag	Side impact, rollover, frontal impact
PRE-SAFE® Impulse Side	Side impact

The front passenger air bag can only be deployed in an accident if the PASSENGER AIR BAG OFF indicator lamp is extinguished. If the front passenger seat is occupied, make sure,

both before and during the journey, that the status of the front passenger air bag is correct (→ page 37).

⚠ WARNING Risk of burns from hot air bag components

The air bag parts are hot after an air bag has been deployed.

- ▶ Do not touch the air bag parts.
- ▶ Have a deployed air bag replaced at a qualified specialist workshop as soon as possible.

Mercedes-Benz recommends that you have the vehicle towed to a qualified specialist workshop after an accident. This applies especially if an Emergency Tensioning Device or an air bag was triggered.

If the Emergency Tensioning Devices are triggered or an air bag is deployed, you will hear a bang, and a small amount of powder may also be released:

- The bang will not generally affect your hearing.

- In general, the powder released is not hazardous to health but may cause short-term breathing difficulties to persons suffering from asthma or other pulmonary conditions. Provided it is safe to do so, leave the vehicle immediately or open the window in order to prevent breathing difficulties.

Air bags and pyrotechnic Emergency Tensioning Devices contain perchlorate material, which may require special handling or environmental protection measures. National guidelines regarding waste disposal must be observed. In California, see <http://www.dtsc.ca.gov/HazardousWaste/Perchlorate/index.cfm>.

Seat belts

Protection provided by the seat belt

Always fasten your seat belt correctly before starting a journey. A seat belt can only provide the best level of protection if it is worn correctly.

▲ WARNING Risk of injury or death due to incorrectly fastened seat belt

If the seat belt is not worn correctly, it cannot perform its intended protective function. In addition, an incorrectly fastened seat belt can also cause injuries, for example, in the event of an accident or when braking or changing direction suddenly.

▶ Always ensure that all vehicle occupants have their seat belts fastened correctly and are sitting properly.

- The seat belt must:
 - Not be twisted and must fit tightly and snugly across your body.
 - Be routed across the center of your shoulder and as low down across your hips as possible.
- The shoulder section of the seat belt should not touch your neck nor be routed under your arm or behind your back.
- Avoid wearing bulky clothing, e.g. a winter coat.

- Push the lap belt down as far as possible across your hips and pull tight with the shoulder section of the belt. Never route the lap belt across your abdomen.
- Never route the seat belt across sharp, pointed, abrasive or fragile objects.
- Only one person should use each seat belt at any one time. Never allow babies and children to travel sitting on the lap of another vehicle occupant.
- Never secure objects with a seat belt if the seat belt is also being used by one of the vehicle's occupants. Always observe the instructions for loading the vehicle when securing objects, luggage or loads (→ page 92).

The seat belts on the following seats are equipped with a child seat safety feature:

- Front-passenger seat
- Rear seats

The seat belts for the folding bench seat in the cargo compartment are not equipped with a child seat safety feature.

Activate or deactivate the child seat safety feature of the seat belt (→ page 43).

If children are traveling in the vehicle, be sure to observe the instructions and safety notes on "Children in the vehicle" (→ page 41).

Reduced protection

▲ WARNING Risk of injury or death due to incorrect seat position

The seat belt does not offer the intended level of protection if you have not moved the seat backrest to an almost vertical position.

When braking or in the event of an accident, you could slide underneath the seat belt and sustain abdominal or neck injuries, for example.

- ▶ Adjust the seat properly before beginning your journey.
- ▶ Always ensure that the seat backrest is in an almost vertical position and that the shoulder section of your seat belt is

routed across the center of your shoulder.

⚠ WARNING Risk of injury or death when additional restraint systems are not used for persons with a smaller build

Persons under 5 ft (1.50 m) tall cannot wear the seat belt correctly without a suitable additional restraint system.

If the seat belt is not worn correctly, it cannot perform its intended protective function. In addition, an incorrectly fastened seat belt can also cause injuries, for example, in the event of an accident or when braking or changing direction suddenly.

- ▶ Always secure persons under 5 ft (1.50 m) tall in a suitable restraint system.

⚠ WARNING Risk of injury or death due to blocked seat belt buckle or seat belt anchorage

Objects next to the front seat that block the seat belt buckle or the moving seat belt anchorage on the front seat impair the function of the Emergency Tensioning Devices.

The Emergency Tensioning Devices can, then, not function as intended and the seat belt can no longer provide the intended protection.

- ▶ Before starting the journey, make sure that there are no objects around the seat belt buckle or between the front seat and door.

⚠ WARNING Risk of injury or death due to damaged or modified seat belts

Seat belts cannot provide protection in the following situations:

- If the seat belts are damaged, modified, extremely dirty, bleached or dyed

- If the seat belt buckle is damaged or extremely dirty
- If the Emergency Tensioning Devices, seat belt anchorages or seat belt retractors have been modified

Seat belts may be damaged in an accident, although the damage may not be visible, e.g. due to splinters of glass.

Modified or damaged seat belts may tear or fail, e.g. in an accident.

Modified Emergency Tensioning Devices can accidentally trigger or fail to function as intended.

- ▶ Never modify the seat belts, Emergency Tensioning Devices, seat belt anchorages or seat belt retractors.
- ▶ Make sure that the seat belts are undamaged, not worn and clean.
- ▶ Always have the seat belts checked immediately after an accident at a qualified specialist workshop.

Only use seat belts that have been approved for your vehicle by Mercedes-Benz.

⚠ WARNING Risk of injury or death from deployed pyrotechnic Emergency Tensioning Devices

Pyrotechnic Emergency Tensioning Devices that have been deployed are no longer operational and are unable to perform their intended protective function.

- ▶ Therefore, have deployed pyrotechnic Emergency Tensioning Devices immediately replaced at a qualified specialist workshop.

Mercedes-Benz recommends that you have the vehicle towed to a qualified specialist workshop after an accident.

! NOTE Damage caused by trapping the seat belt

If an unused seat belt is not fully retracted, it may become trapped in the door or in the seat mechanism.

- ▶ Always ensure that an unused seat belt is fully retracted.

Fastening and adjusting the seat belts

If the seat belt is pulled quickly or sharply, the seat belt retractor locks. The seat belt strap cannot be pulled out any further.



- ▶ Always engage seat belt tongue (2) of the seat belt into seat belt buckle (1) of the corresponding seat.
- ▶ Press and hold the seat belt outlet release and slide the seat belt outlet into the desired position.
- ▶ Let go of the belt outlet release and ensure that the seat belt outlet locks in position.

Vehicles with PRE-SAFE®: If the front seat belt is not pulled tight across your body, the seat belt adjustment may automatically apply a certain tightening force. Do not hold the seat belt tightly while it is adjusting. You can activate and deactivate the seat belt adjustment function using the multimedia system.

! NOTE Deployment of the Emergency Tensioning Device when the front passenger seat is unoccupied

If the seat belt tongue is engaged in the seat belt buckle of the front passenger seat and the front passenger seat is unoccupied, the Emergency Tensioning Device may deploy in the event of an accident.

- ▶ Only one person should use each seat belt at any one time.

Releasing seat belts

- ▶ Press the release button in the seat belt buckle and guide the seat belt back with the seat belt tongue.

Activating or deactivating seat belt adjustment via the multimedia system

Multimedia system:

➔ [Vehicle](#) ➔ [Vehicle Settings](#) ➔ [Belt Adjustment](#)

- ▶ Activate or deactivate the function.

Seat belt warning for the driver and front passenger

The  seat belt warning lamp in the Instrument Display is a reminder that all vehicle occupants must wear their seat belts correctly.

The  seat belt warning lamp lights up for six seconds after every engine start.

In addition, an acoustic warning tone may sound.

When the driver's and front passenger doors are closed and the driver and front passenger have fastened their seat belts, the seat belt warning goes out.

During a journey, the seat belt warning lights up if:

- The vehicle speed exceeds 15 mph (25 km/h) and the driver's or front passenger seat belt is not fastened.
- The driver or front passenger unfastens their seat belt while the vehicle is in motion.

Airbags

Overview of air bags



- ① Knee air bag
- ② Driver's air bag
- ③ Front-passenger air bag
- ④ Window air bag
- ⑤ Side air bag

The installation location of an air bag is identified by the AIRBAG symbol.

When activated, an air bag can provide additional protection for the respective vehicle occupant.

AIRBAG	Potential protection for ...
Knee air bag	Thigh, knee and lower leg
Driver's air bag, front passenger air bag	Head and ribcage
Window air bag	Head
Side air bag	Ribcage, also pelvis for front seat occupants

The front passenger air bag can be deployed in an accident only if the PASSENGER AIR BAG OFF indicator lamp is off. If the front passenger seat is occupied, make sure, both before and during the journey, that the status of the front passenger air bag is correct (→ page 37).

! **NOTE** Important points to remember if the front passenger seat is unoccupied

In an accident, the components of the restraint system may deploy unnecessarily on the front passenger side if:

- There are heavy objects on the front passenger seat.
- The seat belt tongue is engaged in the seat belt buckle of the front passenger seat and the front passenger seat is unoccupied.

- ▶ Stow objects in a suitable place.
- ▶ Only one person should use each seat belt at any one time.

Protection potential of air bags

Depending on the accident situation, an air bag is able to increase the protection offered by a correctly fastened seat belt.

! **WARNING** Risk of injury or death due to incorrect seat position

If you deviate from the correct seat position, the air bag cannot perform its intended protective function and deployment may even cause further injuries.

To avoid hazardous situations, always make sure that all vehicle occupants:

- Have their seat belt fastened correctly, including pregnant women.
- Are seated properly and that distance to the air bags is as large as possible.
- Observe the following information.
- ▶ Always make sure that there are no objects between the air bag and the vehicle occupant.

To avoid risks resulting from the deployment of the air bag:

- Before starting your journey, adjust your seat correctly; the driver's seat and front passenger seat should be moved as far back as possible.

When doing so, always observe the information on the correct driver's seat position (→ page 77).

- Only hold the steering wheel by the steering wheel rim. This allows the air bag to be deployed without restriction.
- Always lean against the seat backrest when the vehicle is in motion. Do not lean forwards or against the door or side window. Otherwise you will be in the deployment area of the air bags.
- Always keep your feet on the floor. Do not put your feet on the cockpit, for example. Otherwise, your feet will be in the deployment area of the air bag.
- If children are traveling in the vehicle, observe the additional notes (→ page 41).
- Always stow and secure objects correctly.

Objects in the vehicle interior may restrict correct functioning of an air bag. Therefore always ensure that:

- There are no other persons, animals or objects between the vehicle occupants and an air bag.
- There are no objects between the seat, door and door pillar (B-pillar).
- There are no hard objects, e.g. coat hangers, hanging on the grab handles or coat hooks.
- Do not fix any accessory parts, such as cup holders, inside the deployment area of an air bag, e.g. on doors, side windows or side paneling.
- There are no heavy, sharp-edged or fragile objects in the pockets of your clothing. Store such objects in a suitable place.

Reduced air bag protection

⚠ WARNING Risk of injury from modifications to the airbag cover

If you modify an airbag cover or affix objects such as stickers to it, the airbag can no longer function correctly.

▶ Never modify an airbag cover and do not affix objects to it.

The installation location of an air bag can be identified by the designation AIRBAG (→ page 32).

⚠ WARNING Risk of injury or death due to the use of unsuitable seat covers

Unsuitable seat covers can obstruct or prevent the deployment of air bags integrated into the seats.

Consequently, the air bags cannot protect vehicle occupants as they are designed to do. In addition, operation of the automatic front passenger air bag shutoff may be restricted.

- ▶ You should only use seat covers that have been approved for the corresponding seats by Mercedes-Benz.

⚠ WARNING Risk of injury due to malfunctions of the sensors in the door paneling

Sensors to control the airbags are located in the doors. Modifications or work not performed correctly to the doors or door paneling, as well as damaged doors, can lead to the function of the sensors being impaired. The airbags might therefore not function properly any more.

Consequently, the airbags cannot protect vehicle occupants as they are designed to do.

- ▶ Never modify the doors or parts of the doors.
- ▶ Always have work on the doors or door paneling carried out at a qualified specialist workshop.

⚠ WARNING Risk of injury due to deployed airbag

A deployed airbag no longer has a protective function and cannot protect as intended in the event of an accident.

- ▶ Have the vehicle towed to a qualified specialist workshop in order to have the deployed airbag replaced.

Have deployed air bags replaced immediately.

Status of the front passenger airbag

Points to remember when the front passenger seat is occupied

The automatic front passenger air bag shutoff is able to detect whether the front passenger seat is occupied by a person or a child restraint system. The front passenger air bag is enabled or disabled accordingly.

When installing a child restraint system on the front passenger seat:

- Ensure that the child restraint system is positioned correctly (→ page 41).

- Always observe the child restraint system manufacturer's installation instructions.
- Never place objects under or behind the child restraint system, e.g. cushions.
- Fully retract the seat cushion length adjustment.
- The entire base of the child restraint system must always rest on the seat cushion of the front passenger seat.
- The backrest of the forward-facing child restraint system must, as far as possible, be resting on the seat backrest of the front passenger seat.
- The child restraint system must not touch the roof or be put under strain by the head restraints. Adjust the seat backrest inclination and the head restraint setting accordingly.

⚠ WARNING Risk of injury or death due to objects between the sitting surface and the child restraint system

Objects between the sitting surface and the child restraint system could affect the function of the automatic front passenger airbag shutoff.

This could result in the front passenger airbag not functioning as intended during an accident.

- ▶ Do not place any objects between the sitting surface and the child restraint system.
- ▶ The entire base of the child restraint system must always rest on the sitting surface of the front passenger seat.
- ▶ The backrest of the forward-facing child restraint system must lie as flat as possible against the backrest of the front passenger seat.
- ▶ Always comply with the child restraint system manufacturer's installation instructions.

A person in the front passenger seat must:

- Have their seat belt fastened correctly.
- Sit in an almost upright seat position with their back against the seat backrest.
- Sit with their feet resting on the floor, if possible.

Otherwise, the front passenger air bag may be deactivated by mistake, for example, because the front passenger:

- Transfers their weight by supporting themselves on a vehicle armrest.
- Sits in such a way that their weight is raised from the sitting surface.

⚠ WARNING Risk of injury or death due to deactivated front passenger airbag

If the PASSENGER AIR BAG OFF indicator lamp is lit, the front passenger airbag is disabled. It will not be deployed in the event of an accident and cannot perform its intended protective function.

A person in the front passenger seat could then, for example, come into contact with the vehicle interior, especially if the person is sitting too close to the cockpit.

If the front passenger seat is occupied, always ensure that:

- The classification of the person in the front passenger seat is correct and the front passenger airbag is enabled or disabled in accordance with the person in the front passenger seat.
 - The front passenger seat has been moved as far back as possible.
 - The person is seated correctly.
- ▶ Ensure, both before and during the journey, that the status of the front passenger airbag is correct.

PASSENGER AIR BAG indicator lamp

System self-test



When the ignition is switched on, a system self-test is performed during which the two PASSENGER AIR BAG ON and OFF indicator lamps light up simultaneously.

The status of the front passenger airbag is then displayed:

- PASSENGER AIR BAG ON lights up for 60 seconds, subsequently both indicator lamps are off (PASSENGER AIR BAG ON and OFF): the front passenger airbag is able to deploy in the event of an accident.
- PASSENGER AIR BAG OFF lights up continuously: the front passenger airbag is disabled. It will then not be deployed in the event of an accident.

If the PASSENGER AIR BAG ON indicator lamp is off, only the PASSENGER AIR BAG OFF indicator lamp shows the status of the front passenger airbag. The PASSENGER AIR BAG OFF indicator lamp may be lit continuously or be off.

If the PASSENGER AIR BAG OFF indicator lamp and the  restraint system warning lamp light up simultaneously, the front passenger seat may not be used. Also in this case, do not install a child restraint system on the front passenger seat. Have the automatic front passenger airbag shutoff checked and repaired immediately at a qualified specialist workshop.

Status display

If the front passenger seat is occupied, ensure, both before and during the journey, that the status of the front passenger air bag is correct for the prevailing situation.

After installing a rearward-facing child restraint system on the front passenger seat: PASSENGER AIR BAG OFF must be lit continuously.

⚠ WARNING Risk of injury or death caused by using a rearward-facing child restraint system when the front passenger airbag is enabled

If you secure a child in a rearward-facing child restraint system on the front passenger seat and the PASSENGER AIR BAG OFF indicator lamp is off, the front passenger airbag can deploy in the event of an accident.

The child could be struck by the airbag.

Always make sure that the front passenger airbag is disabled. The PASSENGER AIR BAG OFF indicator lamp must be lit.

When installing a child restraint system on the front passenger seat, observe the vehicle-specific information (→ page 35).

Depending on the child restraint system and the stature of the child, the PASSENGER AIR BAG OFF indicator lamp may be off. In this case, do not install the rearward-facing child restraint system on the front passenger seat.

Instead, install the rearward-facing child restraint system on a suitable rear seat.

After installing a forward-facing child restraint system on the front passenger seat: depending on the child restraint system and the stature of the child, PASSENGER AIR BAG OFF may be lit continuously or be off. Always observe the following information.

⚠ WARNING Risk of injury or death due to incorrect positioning of the forward-facing child restraint system

If you secure a child in a forward-facing child restraint system on the front passenger seat and you position the front passenger seat too close to the cockpit, in the event of an accident, the child could:

- Come into contact with the vehicle interior if the PASSENGER AIR BAG OFF indicator lamp is lit, for example.
- Be struck by the air bag if the PASSENGER AIR BAG OFF indicator lamp is off.

▶ Always move the front passenger seat as far back as possible and fully retract the seat cushion length adjustment. Always make sure that the shoulder belt strap is correctly routed from the seat belt outlet on the vehicle to the shoulder belt guide on the child restraint system. The shoulder belt strap must be routed forwards and downwards from the vehicle belt outlet. If necessary,

adjust the seat belt outlet and the front passenger seat accordingly.

▶ Always observe the child restraint system manufacturer's installation instructions.

When installing a child restraint system on the front passenger seat, observe the vehicle-specific information (→ page 35).

If a person is sitting in the front passenger seat: PASSENGER AIR BAG OFF may be lit continuously or be off, depending on the person's stature. Always observe the following information.

If the front passenger seat is occupied by:

- An adult or a person with a build corresponding to that of an adult, the PASSENGER AIR BAG OFF indicator lamp must be off. This indicates that the front passenger air bag is enabled.

If the PASSENGER AIR BAG OFF indicator lamp is lit continuously, an adult or person with a build corresponding to that of an adult

should not use the front passenger seat. Instead, they should use a rear seat.

- A person with a smaller build (e.g. a teenager or small adult), the PASSENGER AIR BAG OFF indicator lamp either lights up and remains lit depending on the result of the classification or, alternatively, goes out.
 - PASSENGER AIR BAG OFF is off: move the front passenger seat as far back as possible or a person of smaller stature should use a rear seat.
 - If the PASSENGER AIR BAG OFF indicator lamp is lit continuously: a person of smaller stature should not use the front passenger seat.

⚠ WARNING Risk of injury or death when the PASSENGER AIR BAG OFF indicator lamp is lit

If the PASSENGER AIR BAG OFF indicator lamp remains lit after the system self-test, the front passenger air bag is deactivated. It will not be deployed in the event of an accident. In this case, the front passenger air bag

cannot perform its intended protective function, e.g. when a person is seated in the front passenger seat.

That person could, for example, come into contact with the vehicle interior, especially if the person is sitting too close to the cockpit.

If the front passenger seat is occupied, always ensure that:

- The classification of the person in the front passenger seat is correct and the front passenger air bag is enabled or deactivated in accordance with the person in the front passenger seat.
- The person is seated properly with a correctly fastened seat belt.
- The front passenger seat has been moved as far back as possible.

Further related subjects:

- Child restraint system on the front passenger seat (→ page 47).

PRE-SAFE® system

Information on PRE-SAFE® (anticipatory occupant protection)

PRE-SAFE® is able to detect certain critical driving situations and implement pre-emptive measures to protect the vehicle occupants.

PRE-SAFE® can implement the following measures independently of each other:

- Tightening the seat belts on the driver's seat and front passenger seat.
- Closing the side windows.
- **Vehicles with sliding sunroof:** Closing the sliding sunroof.
- **Vehicles with memory function:** Adjusting the front passenger seat to a more favorable seat position.
- **Vehicles with multicontour seat:** Increasing the air pressure in the seat side bolsters of the seat backrest.
- PRE-SAFE® Sound: provided that the multimedia system is switched on, generates a

brief noise signal to stimulate the innate protective mechanism of a person's hearing.

! **NOTE** Damage caused by objects in the footwell or behind the seat

The automatic adjustment of the seat position may result in damage to the seat and/or the object.

▶ Stow objects in a suitable place.

Reversing PRE-SAFE® measures

If an accident did not occur, the pre-emptive measures that were taken are reversed. You will need to perform certain settings yourself.

▶ If the seat belt pre-tensioning is not reduced, move the seat backrest back slightly. The locking mechanism releases.

Information on PRE-SAFE® PLUS (anticipatory occupant protection plus)

PRE-SAFE® PLUS can detect certain impacts, particularly an imminent rear impact, and take pre-emptive measures to protect the vehicle occupants. These measures cannot necessarily prevent an imminent impact.

PRE-SAFE® PLUS can implement the following measures independently of each other:

- Tightening the seat belts on the driver's seat and front passenger seat.
If an accident does not occur, the pre-emptive measures that were taken are reversed .
- Increasing brake pressure when the vehicle is stationary. This brake application is canceled automatically when the vehicle pulls away.

PRE-SAFE® PLUS system limitations

- No measures are implemented:
 - If the vehicle is backing up.
- The brakes are not applied:
 - Whilst driving.

or

- When entering or exiting a parking space using Parking Pilot.

Information on PRE-SAFE® Impulse Side

If an imminent side impact is detected, PRE-SAFE® Impulse Side can pre-emptively move the front-seat vehicle occupant's upper body toward the center of the vehicle. It does this by rapidly inflating an air cushion in the outer seat side bolster of the seat backrest on the side on which the impact is anticipated. This increases the distance between the door and the vehicle occupant.

If PRE-SAFE® Impulse Side has been deployed or is malfunctioning, the display message **PRE-SAFE Impulse Side Inoperative See Operator's Manual** is displayed (→ page 327).

Children in the vehicle

Notes on the safe transportation of children

⚠ WARNING Risk of accident and injury due to children left unattended in the vehicle

If you leave children unaccompanied in the vehicle, they may be able to set the vehicle in motion, for example by:

- Releasing the parking brake.
- Shifting the transmission out of park position **P**.
- Starting the engine.

In addition, they may operate vehicle equipment.

- ▶ Never leave children and animals unattended in the vehicle.
- ▶ When leaving the vehicle, always take the SmartKey with you and lock the vehicle.

⚠ WARNING Risk of fatal injury due to exposure to extreme heat or cold in the vehicle

If people – particularly children – are exposed to extreme heat or cold over an extended period of time, there is a risk of injury or even fatal injury.

- ▶ Never leave anyone – particularly children – unattended in the vehicle.

⚠ WARNING Risk of burns when the child seat is exposed to direct sunlight

If the child restraint system is exposed to direct sunlight or heat, parts could heat up.

Children could suffer burns from these parts, particularly on metallic parts of the child restraint system.

- ▶ Always make sure that the child restraint system is not exposed to direct sunlight.
- ▶ Protect it with a blanket, for example.

- ▶ If the child restraint system has been exposed to direct sunlight, allow it to cool before securing a child into it.
- ▶ Never leave children unattended in the vehicle.

The use of seat belts and child restraint systems is required by law in:

- All 50 states
- The U.S. territories
- The District of Columbia
- All Canadian provinces

All child restraint systems must meet the following standards:

- U.S. Federal Motor Vehicle Safety Standards 213 and 225
- Canadian Motor Vehicle Safety Standards 213 and 210.2

You can obtain further information about the correct child restraint system from any authorized Mercedes-Benz Center.

To improve protection for children younger than 12 years old and under 5 ft (1.50 m) in height, Mercedes-Benz recommends you observe the following notes:

- Only secure children using a child restraint system which is suitable and recommended for Mercedes-Benz vehicles, as well as appropriate to the height, age and weight of the child. Be sure to observe the instructions for correct use of the child restraint system.
- Always install a child restraint system on a rear seat if possible.
- Only use the following securing systems for child restraint systems:
 - the seat belt system
 - the LATCH-type (ISOFIX) mounting bracket
 - the Top Tether anchorages
- The manufacturer's installation instructions for the child restraint system.
- The warning labels in the vehicle interior and on the child restraint system.

⚠ WARNING Risk of injury or death caused by incorrect installation of the child restraint system

If the child restraint system is incorrectly installed on a suitable seating position, it cannot perform its intended protective function.

The child cannot be restrained in the event of an accident, heavy braking or a sudden change of direction.

- ▶ Always comply with the manufacturer's installation instructions for the child restraint system and its correct use.
- ▶ Make sure that the entire base of the child restraint system always rests on the sitting surface of the seat.
- ▶ Never place objects under or behind the child restraint system, e.g. cushions.
- ▶ Always use child restraint systems with the original cover designed for them.
- ▶ Always replace damaged covers with genuine covers.

⚠ WARNING Risk of accident caused by incorrectly installed child restraint systems

If the child restraint system is not correctly installed or secured, it could release in the event of an accident, sudden braking or a sudden change in direction.

The child restraint system could be flung around and hit vehicle occupants. This poses an increased risk of injury or even fatal injury.

- ▶ Always install child restraint systems correctly, even when not in use.
- ▶ Always comply with the child restraint system manufacturer's installation instructions.

⚠ WARNING Risk of injury or death caused by the use of damaged child restraint systems

Child restraint systems or their retaining systems that have been subjected to a load in

an accident may then not be able to perform their intended protective function.

The child cannot be restrained in the event of an accident, heavy braking or a sudden change of direction.

- ▶ Always replace child restraint systems immediately that have been damaged or involved in an accident.
- ▶ Have the securing systems for the child restraint systems checked at a qualified specialist workshop before installing a child restraint system again.

A booster seat may be necessary to achieve proper seat belt positioning for children over 40 lbs (18 kg) in weight until they reach a height where a three-point seat belt can be installed properly without a booster seat.

The following notes must be observed:

- When installing a child restraint system on the front passenger seat, the information on installing a child restraint system on the front passenger seat (→ page 47).

- Instructions and safety notes on the automatic front passenger airbag shutoff (→ page 35).
- Safety notes on the seat belt (→ page 28).
- Information on the correct use of the seat belt (→ page 32).

Activating/deactivating the child seat safety feature of the seat belt

⚠ WARNING Risk of injury or death if a seat belt is unfastened while the vehicle is in motion

If the seat belt is released while the vehicle is in motion, the child restraint system is no longer correctly secured. The child seat safety feature is deactivated and the seat belt is drawn in a bit by the inertia reel.

It is therefore not possible to engage the seat belt again.

- ▶ Pull over and stop the vehicle safely as soon as possible, paying attention to road and traffic conditions.

- ▶ Activate the child seat safety feature again and correctly secure the child restraint system.

When enabled, the child seat safety feature ensures that the seat belts of the front passenger seat and rear seats do not slacken once the child restraint system is secured.

Installing a child restraint system:

- ▶ Always comply with the manufacturer's installation instructions when installing and removing the child restraint system.
- ▶ Pull the seat belt smoothly from the seat belt outlet.
- ▶ Engage the seat belt tongue in the seat belt buckle.

Activating the child seat safety feature:

- ▶ Pull the seat belt out fully and let the inertia reel retract it again. When the child seat safety feature is activated, you should hear a ratcheting sound.
- ▶ Push the child restraint system down until the seat belt sits tightly.

Deactivating the child seat safety feature:

- ▶ Press the release button of the seat belt buckle.
- ▶ Hold the seat belt tongue and guide it back to the seat belt outlet.

LATCH-type (ISOFIX) child seat attachment**Notes on LATCH-type (ISOFIX) child seat securing systems**

⚠ WARNING Risk of injury or death when using the LATCH-type (ISOFIX) child restraint system and exceeding the permissible weight limit

LATCH-type (ISOFIX) child restraint systems do not offer sufficient protection for children weighing more than 49 lb (22 kg), who are secured using the seat belt integrated in the child restraint system.

For example, the child may not be restrained correctly in the event of an accident.

- ▶ If the child weighs more than 49 lb (22 kg), only use LATCH-type (ISOFIX)

child restraint systems with which the child is secured with the vehicle seat belt.

- ▶ Also secure the child restraint system with the Top Tether belt, if available.

When installing a child restraint system, be sure to observe the manufacturer's installation and operating instructions and the instructions for correct use of the child restraint system.

ISOFIX is a standardized securing system for specially designed restraint systems. LATCH-type (ISOFIX) child restraint systems are approved in accordance with ECE R-44.

Only child restraint systems that have been approved in accordance with ECE R-44 may be attached to LATCH-type (ISOFIX) mounting brackets.



Symbol for installing a LATCH-type (ISOFIX) child restraint system

Installing LATCH-type (ISOFIX) child seat attachments

⚠ WARNING Risk of injury when using the LATCH-type (ISOFIX) child restraint system and exceeding the permissible weight

LATCH-type (ISOFIX) child restraint systems do not offer sufficient protection for children weighing more than 49 lb (22 kg) who are secured using the seat belt integrated in the child restraint system.

For example, the child may not be restrained correctly in the event of an accident. This poses an increased risk of injury or even fatal injury.

- ▶ If the child weighs more than 49 lb (22 kg), only use LATCH-type (ISOFIX) child restraint systems with which the child is secured using the seat belt of the vehicle seat.
- ▶ Also secure the child restraint system with the Top Tether belt, if available.

When installing a child restraint system, be sure to observe the manufacturer's installation instructions and the instructions for correct use of the child restraint system.

Before every trip, make sure that the LATCH-type (ISOFIX) child restraint system is engaged correctly in both LATCH-type (ISOFIX) mounting brackets.

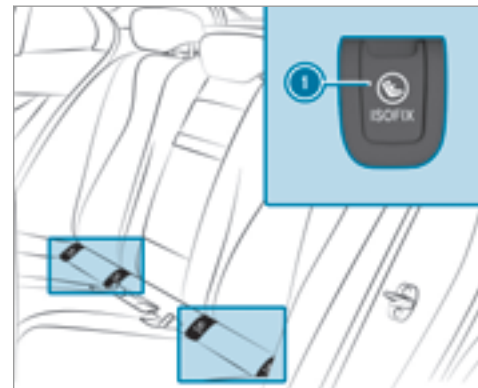

① LATCH-type (ISOFIX) mounting brackets

! NOTE Damage to the seat belt for the center seat

When installing a child restraint system, the seat belt for the center seat could be damaged.

- ▶ Make sure that the seat belt is not trapped.

- ▶ Remove each cover for LATCH-type (ISOFIX) mounting brackets ①.
- ▶ Attach the LATCH-type (ISOFIX) child restraint system to both LATCH-type (ISOFIX) mounting brackets ①.
- ▶ After removing the child seat, replace each cover for LATCH-type (ISOFIX) mounting brackets ①.

Securing Top Tether

⚠ WARNING Risk of injury or death if the rear seat backrests are not locked after installing Top Tether belts

If the rear seat backrests are not locked, they could fold forwards in the event of an accident or during braking or sudden changes of direction.

As a result, child restraint systems cannot perform their intended protective function.

Rear seat backrests that are not locked can also cause additional injuries, e.g. in the event of an accident.

- ▶ Always lock rear seat backrests after installing Top Tether belts.
- ▶ Observe the lock verification indicator.

If the seat backrest is not engaged and locked, this will be shown in the multifunction display in the instrument cluster.

The risk of injury can be reduced by Top Tether as Top Tether provides an additional connection between the child restraint system secured with LATCH-type (ISOFIX) and the vehicle.

The child restraint system must be equipped with a Top Tether belt.

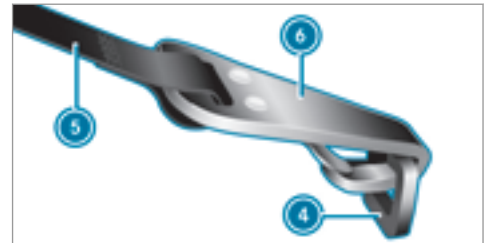
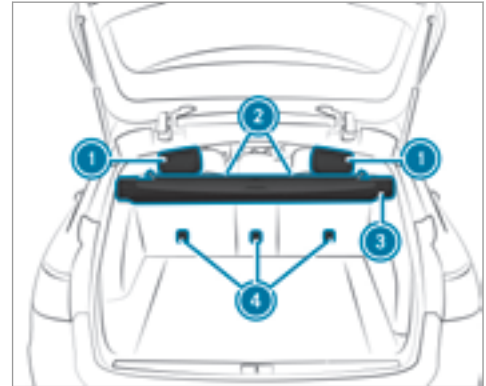

- ▶ If necessary, move head restraint ① upwards Adjusting the rear seat head restraints(→ page 84).
- ▶ Install the LATCH-type (ISOFIX) child restraint system with Top Tether. Always comply with the child restraint system manufacturer's installation instructions when doing so.
- ▶ Route Top Tether belt ⑤ under head restraint ① between the two head restraint bars.
- ▶ Guide Top Tether belt ⑤ downwards between combined cargo cover and net ③ and backrest ②.
- ▶ Hook Top Tether hook ⑥ of Top Tether belt ⑤ without twisting into Top Tether anchorage ④.
- ▶ Tension Top Tether belt ⑤. Always comply with the child restraint system manufacturer's installation instructions when doing so.
- ▶ If necessary, move head restraint ① downwards Adjusting the rear seat head restraints(→ page 84). Make sure that you do not interfere with the correct routing of Top Tether belt ⑤.

Child restraint systems on the front passenger seat

Notes on child restraint systems on the front passenger seat

Accident statistics show that children secured in the rear seats are safer than children secured in front seats. For this reason, Mercedes-Benz strongly advises that you install a child restraint system on a rear seat.

If it is absolutely necessary to install a child restraint system on the front passenger seat, always observe the information on the automatic front passenger air bag shutoff (→ page 35).

By doing this, you can avoid risks caused by:

- A child restraint system that is not detected by the automatic front passenger air bag shutoff.
- The unintentionally deactivated front passenger air bag.
- Incorrect positioning of the child restraint system.

Forward-facing and rearward-facing child restraint systems on the front passenger seat

When using a rearward-facing child restraint system on the front passenger seat, the front passenger air bag must always be deactivated. This is only the case if the PASSENGER AIR BAG OFF indicator lamp is lit continuously (→ page 37).

When using a child restraint system on the front passenger seat, it is essential to observe the following:

- Move the front passenger seat as far back as possible.
- Set the seat backrest to an almost vertical position.
- Retract the seat cushion length as far as possible.
- The entire base of the child restraint system must always rest on the seat cushion of the front-passenger seat.
- The backrest of the forward-facing child restraint system must, as far as possible, be resting on the seat backrest of the front

passenger seat. The child restraint system must not touch the roof or be put under strain by the head restraints.

- If necessary, adjust the angle of the seat backrest and the head restraint position accordingly.
- Move the seat cushion inclination to the highest, most vertical position.
- Always make sure that the shoulder belt strap is correctly routed from the seat belt outlet of the vehicle to the shoulder belt guide on the child restraint system. The shoulder belt strap must be routed forwards and downwards from the seat belt outlet.
- If necessary, adjust the seat belt outlet and the front passenger seat accordingly.
- Never place objects, for example, a cushion, under or behind the child restraint system.

Always comply with the manufacturer's installation and operating instructions for the child restraint system used.

Child safety locks

Activating/deactivating the child safety lock for the rear doors

⚠ WARNING Risk of accident and injury due to children left unattended in the vehicle

If you leave children unaccompanied in the vehicle, they may be able to set the vehicle in motion, for example by:

- Releasing the parking brake.
- Shifting the transmission out of park position **P**.
- Starting the engine.

In addition, they may operate vehicle equipment.

- ▶ Never leave children and animals unattended in the vehicle.
- ▶ When leaving the vehicle, always take the SmartKey with you and lock the vehicle.

⚠ WARNING Risk of fatal injury due to exposure to extreme heat or cold in the vehicle

If people – particularly children – are exposed to extreme heat or cold over an extended period of time, there is a risk of injury or even fatal injury.

- ▶ Never leave anyone – particularly children – unattended in the vehicle.

⚠ WARNING There is a risk of accident and injury if you leave children unattended in the vehicle

If children are traveling in the vehicle, they could:

- Open doors, thereby endangering other persons or road users.
- Get out of the vehicle and be hit by oncoming traffic.
- Operate vehicle equipment and become trapped, for example.

- ▶ Always activate the child safety locks available if children are traveling in the vehicle.
- ▶ Never leave children unattended in the vehicle.
- ▶ When leaving the vehicle, always take the SmartKey with you and lock the vehicle.

Child safety locks are available for the rear doors and for the rear side windows. The child safety lock on the rear doors secures each door separately. The doors can no longer be opened from the inside.

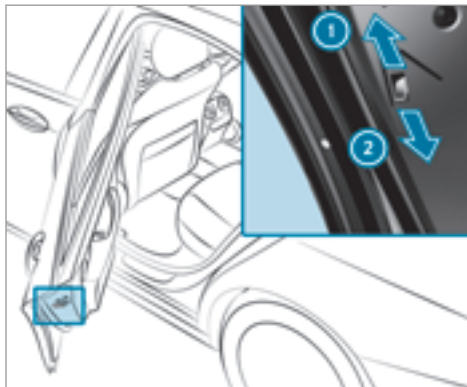

- ▶ Press the lever in direction ① (**activate**) or ② (**deactivate**).
- ▶ Make sure that the child safety locks are working properly.

Activating/deactivating the child safety lock for the rear side windows

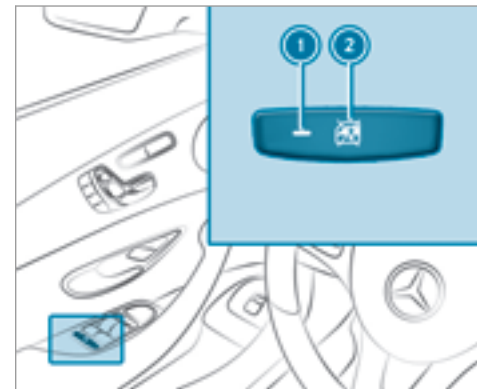

- ▶ **To activate/deactivate:** press button ②. Opening/closing the rear side windows is possible:
 - With indicator lamp ① lit: via the switch on the driver's door.

- With indicator lamp ① off: via the switch on the corresponding rear door or driver's door.

i **Vehicles with folding bench seat** :The switch for opening the tailgate which is located on the right-hand wheel arch when viewed in the direction of travel is also secured.

Pets in the vehicle

⚠ WARNING Risk of accident and injury due to animals left unsecured or unattended in the vehicle

If you leave animals in the vehicle unattended or unsecured, they could possibly press down buttons or switches.

Thereby an animal may:

- activate vehicle equipment and become trapped, for example
- switch systems on or off and endanger other road users

Unsecured animals may be thrown around in the vehicle in the event of an accident or sudden steering and braking maneuver and injure vehicle occupants in the process.

- ▶ Never leave animals in the vehicle unattended.
- ▶ Always correctly secure animals while driving, for example using a suitable animal carrier.

SmartKey

Overview of SmartKey functions

⚠ WARNING - Danger of accident or injury if children are left unattended in the vehicle

If children are left unattended in the vehicle, they could:

- open doors, thereby endangering other persons or road users.
- get out of the vehicle and be hit by oncoming traffic.
- operate vehicle equipment.

Moreover, children could also set the vehicle in motion by, for example:

- releasing the parking brake.
- shifting the automatic transmission out of park position P **[P]** or shifting manual transmission into idle position.
- starting the engine.

- ▶ Never leave children and animals unattended in the vehicle.
- ▶ When leaving the vehicle, always take the key with you and lock the vehicle.
- ▶ Keep the vehicle key out of the reach of children.

! NOTE Damage to the key caused by magnetic fields

- ▶ Keep the key away from strong magnetic fields.



- ① Locks
- ② Battery check lamp
- ③ Unlocks
- ④ Opens/closes the tailgate
- ⑤ Panic alarm



The SmartKey locks and unlocks the following components:

- The doors
- The tailgate
- The fuel filler flap

If you do not open the vehicle within approximately 40 seconds after unlocking:

- The vehicle is locked again.
- Anti-theft protection is reactivated.

Do not keep the SmartKey together with electronic devices or metal objects. This can affect the SmartKey's functionality.

- ❗ If battery check lamp ❷ does not light up after pressing the  or  button, the battery is discharged.

Activating/deactivating the acoustic locking verification signal

Multimedia system:

➔ Vehicle ➔ Vehicle Settings ➔ Acoustic Lock Feedback

- ▶ Activate or deactivate the function.

Priming/deactivating the panic alarm

Prerequisites

- Ignition switched off.





- ▶ **To prime:** press button ❶ for approximately one second.
A visual and audible alarm is triggered.
- ▶ **To deactivate:** briefly press button ❶ again.
- or
- ▶ Press the start/stop button on the cockpit (the SmartKey is inside the vehicle).

Changing the unlocking settings

Possible unlocking functions of the key:

- Central unlocking
- Unlocking the driver's door and fuel filler flap

- ▶ **To switch between settings:** press the  and  buttons simultaneously for approximately six seconds until the battery check lamp flashes twice.

If the unlocking function for the driver's door and fuel filler flap has been selected:

- Pressing the  button a second time centrally unlocks the vehicle.
- **Vehicles with KEYLESS-GO:** If you touch the inner surface of the door handle on the driver's door, only the driver's door and fuel filler flap are unlocked.

Reducing the energy consumption of the SmartKey







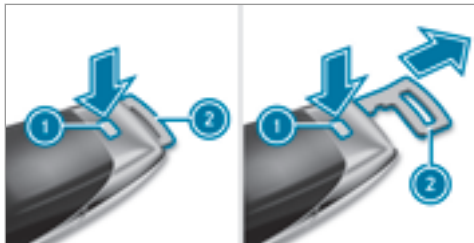

If you do not intend to use the vehicle for an extended period of time, you can deactivate the following functions on the SmartKey.

- KEYLESS-GO starting function
- KEYLESS-GO

- ▶ **To deactivate:** press the  button on the SmartKey twice in rapid succession. The battery check lamp of the SmartKey flashes twice briefly and lights up once.
 - ▶ **To activate:** press any button on the SmartKey.
- ⓘ When the vehicle is started with the SmartKey in the stowage compartment of the center console (→ page 135), the SmartKey functions are automatically activated.

Inserting/removing the mechanical key



- ▶ **To remove:** press release knob . Mechanical key  is pushed out slightly.
 - ▶ Pull out mechanical key  until it engages in the intermediate position.
- ⓘ You can use the intermediate position of mechanical key  to attach the SmartKey to a key ring.
- ▶ Press release knob  again and fully remove mechanical key .
 - ▶ **To insert:** press release knob .
 - ▶ Insert mechanical key  to the intermediate position or fully until it engages.

Replacing the SmartKey battery

⚠ DANGER Serious damage to health caused by swallowing batteries

Batteries contain toxic and corrosive substances. Swallowing batteries may cause serious damage to health.

There is a risk of fatal injury.

- ▶ Keep batteries out of the reach of children.
- ▶ If batteries are swallowed, seek medical attention immediately.

 **ENVIRONMENTAL NOTE** Environmental damage caused by improper disposal of batteries



Batteries contain pollutants. It is illegal to dispose of them with the household rubbish.



▶ Dispose of batteries in an environmentally responsible manner. Take discharged batteries to a qualified specialist workshop or to a collection point for used batteries.

Requirements

You require a CR 2032 3 V cell battery.

Mercedes-Benz recommends that you have the battery replaced at a qualified specialist workshop.

- ▶ Remove the mechanical key (→ page 53).



- ▶ Press release button (2) down fully and remove cover (1).
- ▶ Remove battery compartment (3) and take out the discharged battery.
- ▶ Insert the new battery into battery compartment (3). Observe the positive pole marking in the battery compartment and on the battery.
- ▶ Push in battery compartment (3).
- ▶ Replace cover (1) so that it engages.

Problems with the SmartKey

Problem	Possible causes/consequences and ▶ Solutions
<p>You can no longer lock or unlock the vehicle.</p>	<p>Possible causes are:</p> <ul style="list-style-type: none"> • The SmartKey battery is discharged or nearly discharged. • There is interference from a powerful radio signal source.

Problem	Possible causes/consequences and ► Solutions
	<ul style="list-style-type: none">• The SmartKey is faulty.► Check the battery using the battery check lamp and replace if necessary .► Use the emergency key to lock or unlock the vehicle .► Have the SmartKey checked at a qualified specialist workshop.
You have lost a SmartKey.	<ul style="list-style-type: none">► Have the SmartKey deactivated at a qualified specialist workshop.► If necessary, have the mechanical locking mechanism changed as well.

Doors

Unlocking and opening doors from the inside

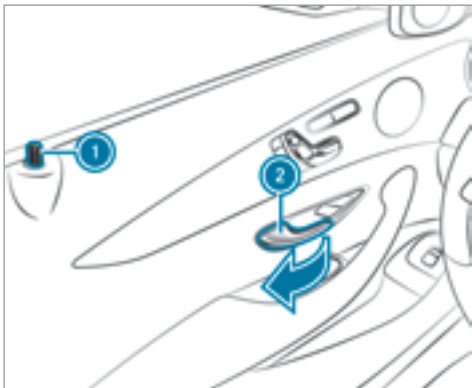

- ▶ **To unlock and open a front door:** pull door handle ②. Locking pin ① pops up when the door is unlocked.

- ▶ **To unlock a rear door:** pull the rear door handle. The locking pin pops up when the rear door is unlocked.
- ▶ **To open a rear door:** pull the rear door handle again.

Locking/unlocking the vehicle centrally from the inside

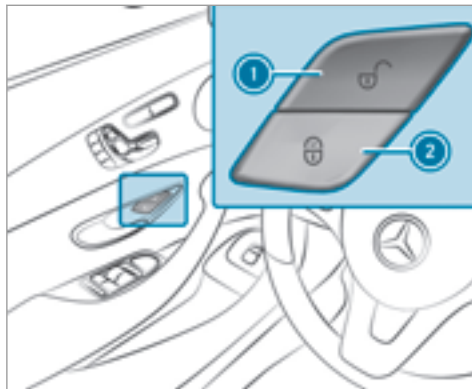

- ▶ **To unlock:** press button ①.
- ▶ **To lock:** press button ②.

This does not lock or unlock the fuel filler flap.

The vehicle is not unlocked:

- If you have locked the vehicle using the SmartKey.
- If you have locked the vehicle using KEY-LESS-GO.

Locking and unlocking the vehicle with KEY-LESS-GO

Requirements

- The SmartKey must be outside the vehicle.
- The distance between the SmartKey and the vehicle must not exceed 3 ft (1 m).
- The driver's door and the door at which the door handle is used must both be closed.

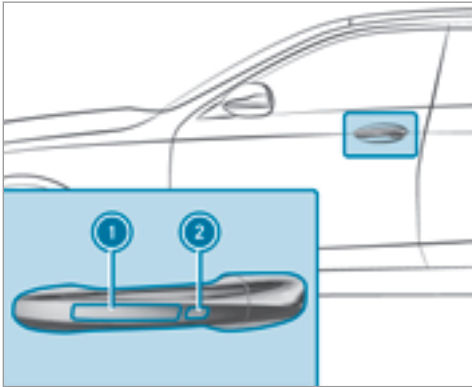

▶ **To unlock the vehicle:** touch the inner surface of the door handle.

▶ **To lock the vehicle:** touch sensor surface ① or ②.

▶ **Convenience closing:** touch recessed sensor surface ② for an extended period.

ⓘ For further information on convenience closing (→ page 68).

If you open the tailgate from outside it is automatically unlocked.

Problems with KEYLESS-GO

Problem	Possible causes/consequences and ▶ Solutions
<p>You can no longer lock or unlock the vehicle using KEYLESS-GO.</p>	<p>Possible causes are:</p> <ul style="list-style-type: none"> • KEYLESS-GO has been deactivated . • The SmartKey battery is discharged or nearly discharged. • There is interference from a powerful radio signal source.

Problem

Possible causes/consequences and ► Solutions

- The SmartKey is malfunctioning.
- Activate KEYLESS-GO .
- Check the battery using the battery check lamp and replace if necessary .
- Use the mechanical key to lock or unlock the vehicle .
- Have the vehicle and SmartKey checked at a qualified specialist workshop.

Switching the automatic locking feature on/off

The vehicle is locked automatically when the ignition is switched on and the wheels are turning faster than walking pace.

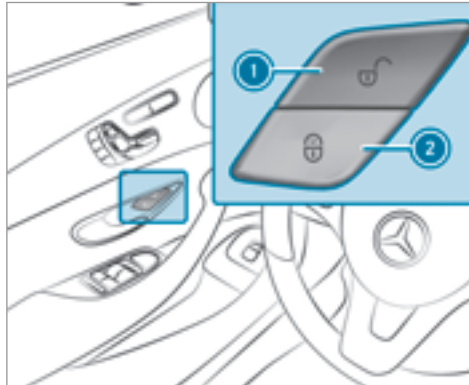

- **To deactivate:** press and hold button ① for approximately five seconds until an acoustic signal sounds.
- **To activate:** press and hold button ② for approximately five seconds until an acoustic signal sounds.

Danger of being locked out when the function is activated:

- If the vehicle is being tow started/pushed.
- On a roller dynamometer.

Unlocking/locking the driver's door using the emergency key

- ❗ If you wish to lock the vehicle entirely using the emergency key, first press the button for locking from the inside while the driver's door is open. Then proceed to lock the driver's door using the emergency key.

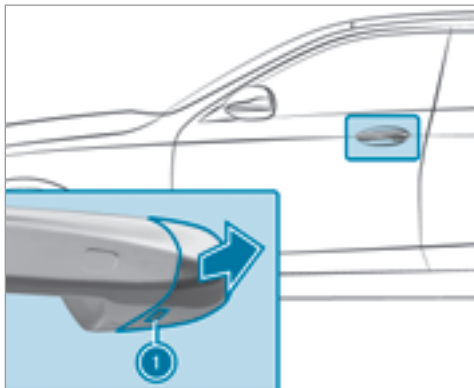

- ▶ Insert the emergency key into opening ❶ in the cover.
- ▶ Pull and hold the door handle.
- ▶ Pull the cover on the emergency key as straight as possible away from the vehicle until it releases.
- ▶ Release the door handle.

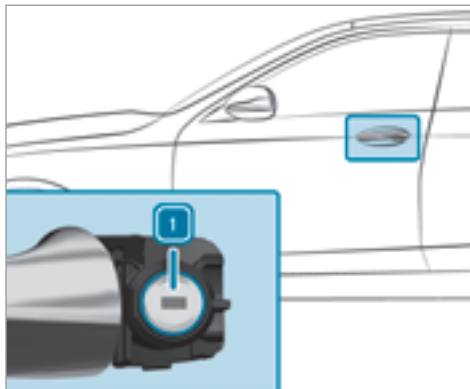

- ▶ **To unlock:** turn the emergency key counter-clockwise to position ❶.
- ▶ **To lock:** turn the emergency key clockwise to position ❶.
- ▶ Carefully press the cover onto the lock cylinder until it engages and is seated firmly.

Load compartment

Opening the tailgate

⚠ WARNING Risk of exhaust gas poisoning

Combustion engines emit poisonous exhaust gases such as carbon monoxide. Exhaust gases can enter the vehicle interior if the tailgate is open when the engine is running, especially if the vehicle is in motion.

- ▶ Always switch off the engine before opening the tailgate.
- ▶ Never drive with the tailgate open.

! **NOTE** Damage to the tailgate caused by obstacles above the vehicle

The tailgate swings rearwards and upwards when it is opened.

- ▶ Make sure that there is sufficient space behind and above the tailgate.

To open the tailgate, the following options are available:

- ▶ Press and hold the  button on the SmartKey.
- ▶ If the tailgate is unlocked, pull the tailgate handle and release it again immediately.
- ▶ With the tailgate stopped in an intermediate position, pull the tailgate upwards. Release it as soon as it begins to open.

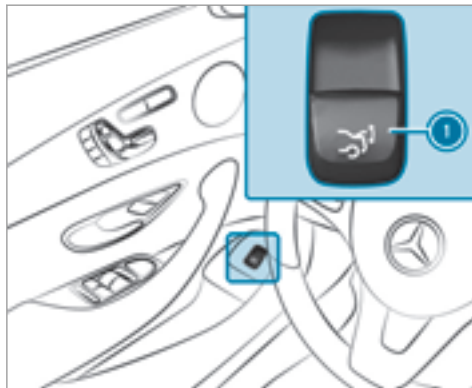

- ▶ Pull remote opening switch ① for the tailgate.
- ▶ **Vehicles with HANDS-FREE ACCESS:** Move your foot below the bumper (→ page 63).

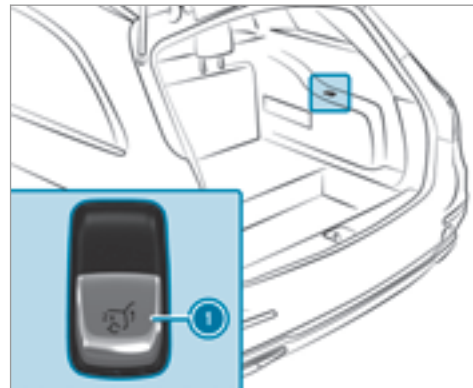

- ▶ **Vehicles with folding bench seat:** Pull button ① for the tailgate twice. The tailgate is unlocked.

If the tailgate has been locked from the outside, or the child safety lock has been activated, the tailgate cannot be unlocked with button ①.

The tailgate is equipped with an automatic obstacle detection function. If a solid object blocks or restricts the tailgate when automati-

cally opening, this process is stopped. The automatic obstacle detection function is only an aid. It is not a substitute for your attentiveness when opening the tailgate.

Closing the tailgate

⚠ WARNING Risk of injury from unsecured items in the vehicle

If objects, luggage or loads are not secured or not secured sufficiently, they could slip, tip over or be flung around and thereby hit vehicle occupants.

There is a risk of injury, particularly in the event of sudden braking or a sudden change in direction.

- ▶ Always store objects in such a way that they cannot be flung around.
- ▶ Before the journey, secure objects, luggage or loads against slipping or tipping over.

⚠ WARNING Risk of becoming trapped during automatic closing of the tailgate

Parts of the body could become trapped during automatic closing of the tailgate. Moreover, people, e.g. children, may be standing in the closing area or may enter the closing area during the closing process.

- ▶ Make sure that nobody is in the vicinity of the closing area during the closing process.

Use one of the following options to stop the closing process:

- Press the  button on the SmartKey.
- Press or pull the remote operating switch on the driver's door.
- Press the closing or locking button on the tailgate.
- Pull the tailgate handle.

Vehicles with HANDS-FREE ACCESS: It is also possible to stop the closing process by moving your foot in a kicking motion under the rear bumper.

To close the tailgate, the following options are available:

- ▶ Pull the tailgate downwards slightly. Release it as soon as it begins to close.
- ▶ Press and hold the  button on the SmartKey (with the SmartKey in the vicinity of the vehicle).

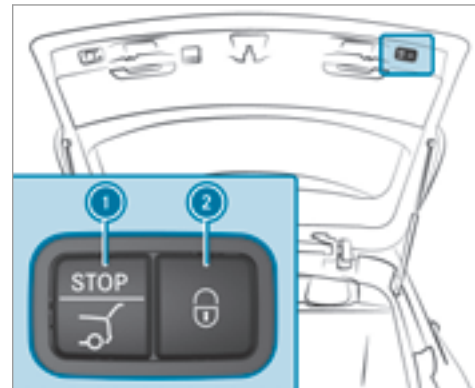

- ▶ Press closing button  on the tailgate.

- ▶ **Vehicles with KEYLESS-GO:** Press locking button ② in the tailgate.
If a SmartKey is detected outside the vehicle, the tailgate closes and the vehicle is locked.

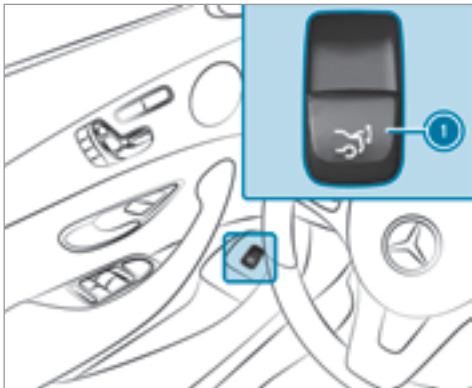

- ▶ Press remote operating switch ① for the tailgate.
- ▶ **Vehicles with HANDS-FREE ACCESS:** Move your foot below the bumper (→ page 63).

Automatic reversing function for the tailgate

The tailgate is equipped with automatic obstacle detection with reversing function. If a solid object blocks or restricts the tailgate when automatically closing, the tailgate automatically opens again slightly. The automatic obstacle detection with reversing function is only an aid. It is not a substitute for your attentiveness when closing the tailgate.

- ▶ When closing, make sure that no body parts are in the closing area.

⚠ **WARNING** Risk of becoming trapped despite the reversing function

The reversing function does not react:

- To soft, light and thin objects, e.g. fingers.
- Over the last $\frac{1}{3}$ in (8 mm) of the closing path.

In these situations in particular, the reversing function cannot prevent someone being trapped.

- ▶ When closing, make sure that no body parts are in the closing area.

If someone is trapped:

- Press the  button on the SmartKey, or
- Press or pull the remote operating switch on the driver's door, or
- Press the closing or locking button on the tailgate, or
- Pull the tailgate handle.

HANDS-FREE ACCESS function



With HANDS-FREE ACCESS you can open, close or stop the closing process of the tailgate by performing a kicking movement under the rear bumper.

The kicking movement triggers the opening or closing process alternately.

Observe the notes when opening (→ page 59) and closing (→ page 61) the tailgate.

i Two warning tones sound when the tailgate is opening or closing.

⚠ WARNING Risk of burns caused by a hot exhaust system

The vehicle exhaust system can become very hot. If you use HANDS-FREE ACCESS, you could burn yourself by touching the exhaust system.

▶ Always ensure that you only make a kicking movement within the detection range of the sensors.

! **NOTE** Vehicle damage due to unintentional opening of the tailgate

- when using an automatic car wash
- when using a high pressure cleaner

▶ Deactivate KEYLESS-GO or make sure that the key located is at least 10 ft

(3 m) away from the vehicle in such situations.

When making the kicking movement, make sure that you are standing firmly on the ground you could otherwise lose your balance, e.g. on ice.

Requirements:

- The SmartKey is behind the vehicle.
- Stand at least 12 in (30 cm) away from the vehicle while performing the kicking movement.
- Do not come into contact with the bumper while making the kicking movement.
- Do not carry out the kicking movement too slowly.
- The kicking movement must be towards the vehicle and back.

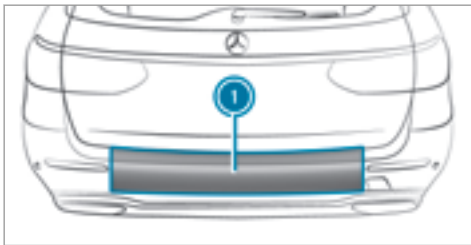

① Sensor detection range

If several consecutive kicking movements are not successful, wait ten seconds.

System limitations

The system may be impaired or may not function if:

- The area around the sensor is dirty, e.g. due to road salt or snow.
- The kicking movement is made using a prosthetic leg.

The tailgate can open or close unintentionally in the following situations:

- If persons' arms or legs move in the sensor detection range, e.g. when polishing the vehicle, sitting on the edge of the cargo compartment, or picking up objects.
- If objects are guided behind or placed behind the vehicle, e.g. charging cables, tensioning straps or luggage.
- When working on the trailer coupling, trailers or rear bicycle racks.

Deactivate KEYLESS-GO (→ page 52) or do not carry the SmartKey about your person in such situations.

Limiting the opening angle of the tailgate

Activating the opening angle limiter

You can limit the opening angle of the tailgate in the top half of its opening range, to approximately 8 in (20 cm) before the end position.

- ▶ Stop the opening procedure of the tailgate at the desired position.

- ▶ Press and hold the closing button in the tailgate until you hear a short acoustic signal. The opening angle limiter is activated. The tailgate then stops in the stored position when opened.

To open the tailgate fully, pull the handle on the outside of the tailgate again after it has stopped automatically.

Deactivating the opening angle limiter

- ▶ Press and hold the closing button on the tailgate until two acoustic signals sound.

Unlocking the tailgate with the mechanical key

- ▶ Fold the rear seat backrest forward.
- ▶ Remove the combined cargo cover and net (→ page 99).

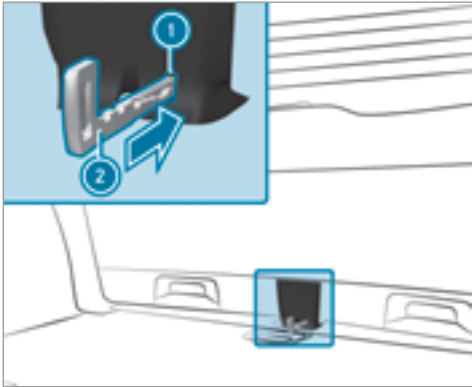

- ▶ Insert mechanical key ② into opening ① in the trim and push it in. The tailgate is unlocked.

Emergency release of the tailgate from the inside (vehicles with a folding bench seat)

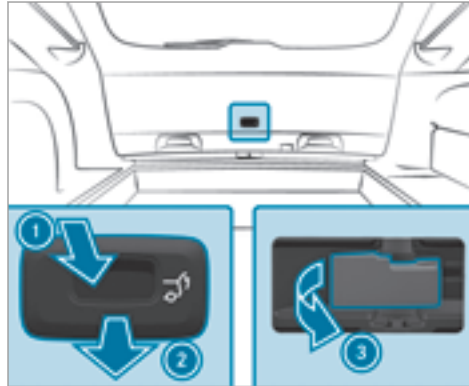

- ▶ Press the cover down in the direction of arrow ① and pull in the direction of arrow ② and remove it.
- ▶ Pull the emergency release lever in the direction of arrow ③. The tailgate is unlocked.

Roller sun blinds

Extending the rear side window roller sun-blinds

! **NOTE** Damage to the inertia reel due to it snapping back

If suddenly snapped back, the inertia reel may be damaged.

- ▶ Always move the roller sun blind by hand.
- ▶ Do not drive with the roller sun blind hooked in and side windows opened at the same time.

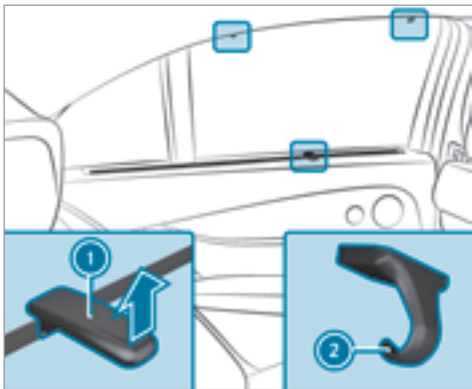

- ▶ Pull the roller sunblind out by tab ① and hook it onto brackets ② at the top of the window.

Side windows

Opening/closing the side windows

- ⚠ **WARNING** Risk of entrapment when opening a side window

When opening a side window, parts of the body could be drawn in or become trapped between the side window and window frame.

- ▶ When opening, make sure that nobody is touching the side window.
- ▶ If someone is trapped, release the button immediately or pull it in order to close the side window again.

- ⚠ **WARNING** Risk of becoming trapped when closing a side window

When closing a side window, body parts could be trapped in the closing area in the process.

- ▶ When closing, make sure that no body parts are in the closing area.

- ▶ If someone is trapped, release the button immediately or press the button in order to reopen the side window.

- ⚠ **WARNING** Risk of becoming trapped when children operate the side windows

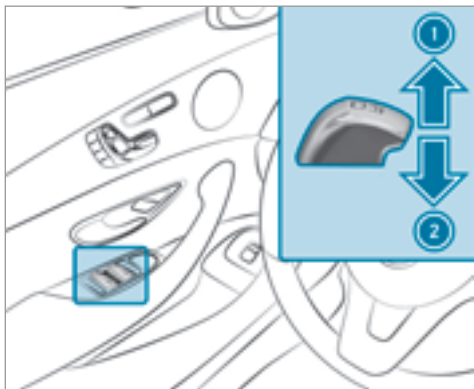

Children could become trapped if they operate the side windows, particularly when unattended.

- ▶ Activate the child safety lock for the rear side windows.
- ▶ When leaving the vehicle, always take the SmartKey with you and lock the vehicle.
- ▶ Never leave children unattended in the vehicle.



- ① Closing
- ② To open

The buttons in the driver's door take precedence.

- ▶ **To start automatic operation:** press/pull the  button beyond the pressure point.
- ▶ **To interrupt automatic operation:** press or pull the  button again.

Automatic reversing function for the side windows

If an object blocks a side window during the closing process, the side window opens again automatically. The automatic reversing function is only an aid and is not a substitute for your attentiveness.

- ▶ When closing, make sure that no body parts are in the closing area.

⚠ WARNING Risk of becoming trapped despite reversing protection on the side window

The reversing function does not react:

- to soft, light and thin objects, e.g. small fingers.
- over the last $\frac{1}{8}$ in (4 mm) of the closing path.
- during resetting.
- when closing the side window again manually immediately after automatic reversing.

This means that the reversing function cannot prevent someone from becoming trapped in these situations.

- ▶ When closing, make sure that no body parts are in the closing area.
- ▶ If someone becomes trapped, press the  button to open the side window again.

Ventilating the vehicle before starting a journey (convenience opening)

⚠ WARNING Risk of entrapment when opening a side window

When opening a side window, parts of the body could be drawn in or become trapped between the side window and window frame.

- ▶ When opening, make sure that nobody is touching the side window.
- ▶ Release the button immediately if somebody becomes trapped.

▶ Press and hold the  button on the SmartKey.

The following functions are performed:

- The vehicle is unlocked.
- The side windows are opened.
- The sliding sunroof is opened.
- The panoramic sliding sunroof is opened.
- The seat ventilation of the driver's seat is switched on.

If the roller sunblinds of the panoramic sliding sunroof are closed, the roller sunblinds are opened first.

▶ **To continue the opening procedure:** press the  button again.

▶ **To interrupt convenience opening:** release the  button.

Closing side windows from the outside (convenience closing)

⚠ WARNING Risk of entrapment caused by inadvertent convenience closing

When the convenience closing feature is operating, parts of the body could become trapped in the closing area of the side window and the sliding sunroof.

▶ Observe the complete closing procedure when using convenience closing.

▶ When closing, make sure that no body parts are in the closing area.

▶ Press and hold the  button on the SmartKey.

The following functions are performed:

- The vehicle is locked.
- The side windows are closed.
- The sliding sunroof is closed.
- The panoramic sliding sunroof is closed.

▶ **To close the roller sunblinds:** press the  button again.

▶ **To interrupt convenience closing:** release the  button.

i Convenience closing can also be operated with KEYLESS-GO (→ page 56).

Problems with the side windows

Problem	Possible causes/consequences and ▶ Solutions
A side window cannot be closed and you cannot see the cause.	▶ Check to see if any objects are in the window guide.

Problem

Possible causes/consequences and ► Solutions

⚠ WARNING Risk of entrapment if reversing protection is not activated

If you close a side window again immediately after it has been blocked or reset, the side window closes with increased or maximum force. The reversing function is then not active.

Parts of the body could be trapped in the closing area in the process.

- ▶ Make sure that no parts of the body are in the closing area.
- ▶ To stop the closing process, release the button or press the button again to reopen the side window.

If a side window is obstructed during closing and reopens again slightly:

- ▶ Immediately after the window blocks, pull the corresponding button again until the side window has closed, and hold the button for an additional second.
The side window is closed with increased force.

If a side window is obstructed again during closing and reopens again slightly:

- ▶ Repeat the previous step.
The side window is closed without the automatic reversing function.

Sliding sunroof

Opening/closing the sliding sunroof

i The term "sliding sunroof" also refers to the panoramic sliding sunroof.

⚠ WARNING Risk of becoming trapped while opening and closing the sliding sunroof

During opening and closing, parts of the body could get caught in the sweep of the sliding sunroof.

- ▶ When opening or closing, make sure that no body parts are in the sweep.
- ▶ Release the button immediately if somebody becomes trapped.

or

- ▶ Press the button in any direction during the automatic opening/closing process. The opening/closing process is stopped.

⚠ WARNING Risk of becoming trapped if the sliding sunroof is operated by children

Children operating the sliding sunroof could get caught in the moving parts, particularly if unattended.

- ▶ Never leave children unattended in the vehicle.
- ▶ When leaving the vehicle, always take the key with you and lock the vehicle.

⚠ WARNING Risk of becoming trapped while opening and closing the roller sun blind

When opening or closing, make sure that no body parts become trapped between the roller sun blind and frame or the sliding sunroof.

- ▶ When opening or closing, make sure that no body parts are in the sweep of the roller sun blind.

- ▶ Release the button immediately if somebody becomes trapped.

or

- ▶ Press the button in any direction during the automatic opening/closing process. The opening/closing process is stopped.

! NOTE Malfunction caused by snow and ice

Snow and ice may lead to a malfunction of the sliding sunroof.

- ▶ Only open the sliding sunroof if it is free of snow and ice.

! NOTE Damage caused by protruding objects

Objects that protrude from the sliding sunroof may damage the sealing strips.

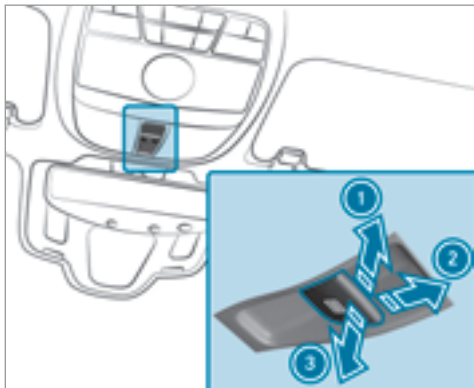

- ▶ Do not allow anything to protrude from the sliding sunroof.



- ① To raise
- ② To open
- ③ To close/lower

Use the  button to operate the panoramic sliding sunroof and the roller sunblind.

- The panoramic sliding sunroof can only be opened when the roller sunblind is open.

- The roller sunblind can only be operated when the panoramic sliding sunroof is closed.
- ▶ **To start automatic operation:** press/pull the  button beyond the pressure point.
- ▶ **To interrupt automatic operation:** press/pull the  button again.

Restrictions:

- **Vehicles without a panoramic sliding sunroof:** The automatic opening and raising feature is available only when the sliding sunroof is closed.
- **Vehicles with a panoramic sliding sunroof:** The automatic raising feature is only available when the sliding sunroof is closed or raised.
- The panoramic sliding sunroof cannot be opened if a roof rack is installed. The panoramic sliding sunroof closes again automatically when it encounters resistance.

Automatic reversing function of the sliding sunroof

If there is an object obstructing the sliding sunroof during the closing process, the sliding sunroof opens again automatically. The automatic reversing function is only an aid and is not a substitute for your attentiveness.

- ▶ When closing, make sure that no body parts are in the closing area.

⚠ WARNING Risk of becoming trapped despite the reversing function being active

The reversing function does not react:

- to soft, light and thin objects, e.g. small fingers
- during the last 1/6 in (4 mm) of the closing path
- during resetting
- when closing the sliding sunroof again manually immediately after automatic reversing

This means that the reversing function cannot prevent someone being trapped in these situations.

- ▶ When closing, make sure that no body parts are in the closing area.
- ▶ Release the button immediately if somebody becomes trapped.

or

- ▶ Press the button in any direction during the automatic closing process.
The closing process is stopped.

Automatic reversing function of the roller sunblind

If there is an object obstructing the roller sunblind during the closing process, the roller sunblind opens again automatically. The automatic reversing function is only an aid and is not a substitute for your attentiveness.

- ▶ When opening or closing the roller sunblind, make sure that no body parts are in the sweep.

⚠ WARNING Risk of becoming trapped despite the reversing function being active

In particular, the reversing function does not react to soft, light and thin objects, for example small fingers.

This means that the reversing function cannot prevent entrapment in these situations.

- ▶ When opening or closing the roller sunblind, make sure that no body parts are in the sweep.
- ▶ Release the button immediately if somebody becomes trapped.

or

- ▶ Press the button in any direction during the automatic closing process.
The closing process is stopped.

Automatic features of the sliding sunroof

- ⓘ The term "sliding sunroof" also refers to the panoramic sliding sunroof.

By pushing or pulling the  button you can interrupt the automatic functions: "Rain closing function when driving" and "Automatic lowering feature".

Rain closing function when driving

Vehicles with a panoramic sliding sunroof: if it starts to rain, the raised sliding sunroof is automatically lowered while the vehicle is in motion.

Automatic lowering feature

Vehicles with a panoramic sliding sunroof: if the sliding sunroof is raised at the rear, the sliding sunroof is automatically lowered slightly at higher speeds. At low speeds it is raised again automatically.

⚠ WARNING Risk of entrapment by automatic lowering of the sliding sunroof

At high speeds the raised sliding sunroof automatically lowers slightly at the rear.

This could trap you or other persons.

- ▶ Make sure that nobody reaches into the sweep of the sliding sunroof whilst the vehicle is in motion.
- ▶ If somebody becomes trapped, immediately pull back the sliding sunroof button.
The sliding sunroof lifts during opening.

Problems with the sliding sunroof

- ❗ The term "sliding sunroof" also refers to the panoramic sliding sunroof.

Problem

The sliding sunroof cannot be closed and you cannot see the cause.

Possible causes/consequences and ▶ Solutions

⚠ WARNING Risk of becoming trapped by closing the sliding sunroof again

If you close the sliding sunroof again immediately after it has been blocked or reset, the sliding sunroof closes with increased or maximum force.







The reversing function is then not active. Parts of the body could be trapped in the closing area in the process. This poses an increased risk of injury or even fatal injury.

- ▶ Make sure that no parts of the body are in the closing area.
- ▶ Release the button immediately if somebody becomes trapped.

or

- ▶ Press the button in any direction during the automatic closing process.
The closing process is stopped.

If the sliding sunroof is obstructed during closing and reopens again slightly:

Problem	Possible causes/consequences and ► Solutions
	<ul style="list-style-type: none"> ► Immediately after automatic reversing, pull and hold the  button down again to the point of resistance until the sliding sunroof is closed. The sliding sunroof is closed with increased force. <p>If the sliding sunroof is obstructed again and reopens again slightly:</p> <ul style="list-style-type: none"> ► Repeat the previous step. The sliding sunroof is closed again with increased force.
<p>Vehicles without a panoramic sliding sunroof: the sliding sunroof does not operate smoothly.</p>	<ul style="list-style-type: none"> ► Raise the sliding sunroof fully at the rear. ► Press the  button for another second. ► Use automatic operation to fully raise and then close the sliding sunroof.
<p>Vehicles with a panoramic sliding sunroof: the sliding sunroof or the roller sunblind does not operate smoothly.</p>	<ul style="list-style-type: none"> ► Pull the  button down repeatedly to the point of resistance until the sliding sunroof is fully closed. ► Pull the  button for another second. ► Pull and hold the  button down until the roller sunblind is completely closed. ► Pull the  button for another second. ► Use automatic operation to fully open and then close the sliding sunroof.

Anti-theft protection

Immobilizer

The immobilizer prevents your vehicle from being started without the correct key.

The immobilizer is automatically activated when the ignition is switched off and deactivated when the ignition is switched on.

When leaving the vehicle, always take the key with you and lock the vehicle. Anyone can start the engine if a valid key has been left inside the vehicle.

- ❗ In the event that the engine cannot be started (yet the starter battery is charged), the system is not operational. Contact an authorized Mercedes-Benz Center or call 1-800-FOR-MERCEdes (in the USA) or 1-800-387-0100 (in Canada).

ATA (anti-theft alarm system)

Function of the ATA system (anti-theft alarm system)

If the ATA system is armed, a visual and audible alarm is triggered in the following situations:

- A door is opened.
- The tailgate is opened.
- The hood is opened.

The ATA system is armed automatically after approximately 10 seconds:

- After locking the vehicle with the SmartKey.
- After locking the vehicle using KEYLESS-GO.

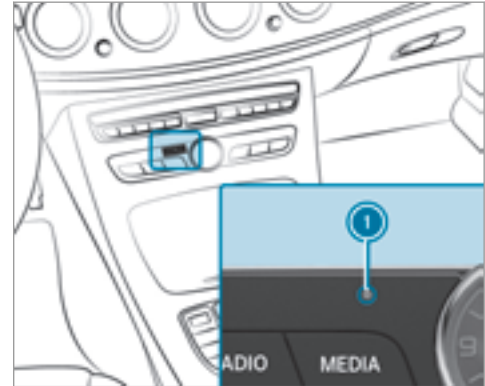

When the ATA system is armed, indicator lamp ❶ flashes.

The ATA system is automatically deactivated:

- After unlocking the vehicle with the SmartKey.
- After pressing the start/stop button with the SmartKey inside the vehicle.

- After unlocking the vehicle using KEYLESS-GO.

 When the mbrace service (→ page 232) is active and the alarm stays on for more than 30 seconds, a message is automatically sent to the Customer Assistance Center.

Deactivating the ATA (anti-theft alarm system) alarm

 Press the ,  or  button on the SmartKey.

or

 Press the start/stop button (the SmartKey is inside the vehicle).

Stopping the alarm using KEYLESS-GO

 Grasp the outside door handle (with the SmartKey outside the vehicle).

Correct driver's seat position

⚠ WARNING Risk of injury from adjusting the vehicle settings while the vehicle is in motion

You could lose control of the vehicle in the following situations:

- if you adjust the driver's seat, the head restraint, the steering wheel or the mirror while the vehicle is in motion
- if you fasten your seat belt while the vehicle is in motion

▶ Before starting the engine: adjust the driver's seat, the head restraint, the steering wheel or the mirror and fasten your seat belt.

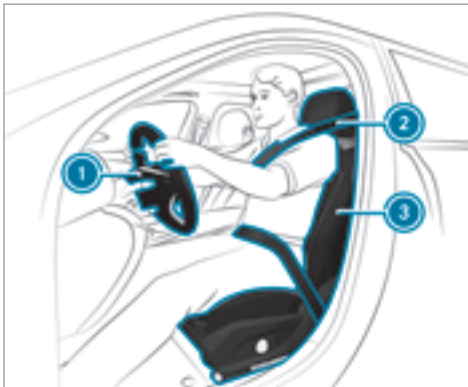

Observe the following when adjusting steering wheel ①, seat belt ② and driver's seat ③:

- you are as far away from the driver's airbag as possible
- you are sitting in a normal upright position
- your thighs are slightly supported by the seat cushion

- your legs are not entirely stretched and you can depress the pedals properly
- the back of your head is supported at eye level by the center of the head restraint
- you can hold the steering wheel with your arms slightly bent
- you can move your legs freely
- you can see all the displays in the instrument cluster clearly
- you should have a good overview of traffic conditions
- the seat belt is pulled snugly against the body and is routed across the center of your shoulder and across your hips in the pelvic area

Seats

Adjusting the front seat manually and electrically (without Seat Comfort Package)

⚠ WARNING Risk of becoming trapped if the seats are adjusted by children

Children could become trapped if they adjust the seats, particularly when unattended.

- ▶ When leaving the vehicle, always take the SmartKey with you and lock the vehicle.
- ▶ Never leave children unattended in the vehicle.

The seats can be adjusted when the ignition is switched off.

⚠ WARNING Risk of becoming trapped when adjusting the seats

When you adjust a seat, you or other vehicle occupants could become trapped, e.g. on the seat guide rail.

- ▶ Make sure when adjusting a seat that no one has any body parts in the sweep of the seat.

Observe the safety notes on "Airbags" and "Children in the vehicle".

⚠ WARNING Risk of accident due to the driver's seat not being engaged

If the driver's seat is not engaged, it could move unexpectedly while the vehicle is in motion.

This could cause you to lose control of the vehicle.

- ▶ Always make sure that the driver's seat is engaged before starting the vehicle.

⚠ WARNING Risk of injury from adjusting the vehicle settings while the vehicle is in motion

You could lose control of the vehicle in the following situations:

- if you adjust the driver's seat, the head restraint, the steering wheel or the mirror while the vehicle is in motion
- if you fasten your seat belt while the vehicle is in motion

- ▶ Before starting the engine: adjust the driver's seat, the head restraint, the steering wheel or the mirror and fasten your seat belt.

⚠ WARNING Risk of becoming trapped if the seat height is adjusted carelessly

If you adjust the seat height carelessly, you or other vehicle occupants could be trapped and thereby injured.

Children in particular could accidentally press the electrical seat adjustment buttons and become trapped.

- ▶ While moving the seats, make sure that hands or other body parts do not get under the lever assembly of the seat adjustment system.

⚠ WARNING Risk of injury due to head restraints which are not installed or are adjusted incorrectly

If head restraints are not installed or are adjusted incorrectly, the head restraints cannot provide protection as intended.

There is an increased risk of injury in the head and neck area, e.g. in the event of an accident or when braking.

- ▶ Always drive with the head restraints installed.
- ▶ Before driving off, make sure for every vehicle occupant that the center of the head restraint supports the back of the head at about eye level.

Do not rotate the head restraints of the front and rear seats. Otherwise, you cannot adjust the height and angle of the head restraints correctly.

Adjust the head restraint fore-and-aft position so that it is as close as possible to the back of your head.

⚠ WARNING Risk of injury due to an incorrect seat position

The seat belt does not offer the intended level of protection if you have not moved the seat backrest to an almost vertical position.

When braking or in the event of an accident, you could slide underneath the seat belt and sustain abdomen or neck injuries, for example. This poses an increased risk of injury or even fatal injury.

- ▶ Adjust the seat correctly before starting the journey.
- ▶ Always ensure that the seat backrest is in an almost vertical position and that the shoulder section of your seat belt is routed across the center of your shoulder.

! NOTE Damage to the seats when moving the seats back

The seats may be damaged by objects when moving the seats back.

- ▶ When moving the seats back, make sure that there are no objects in the footwell or under or behind the seats.

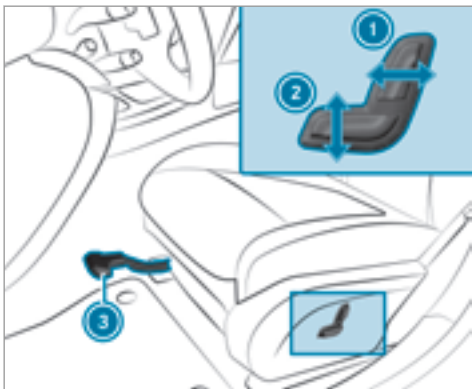

- ① Seat backrest inclination
- ② Seat height
- ③ Seat fore-and-aft position

- ▶ **To adjust the seat fore-and-aft position:** lift lever ③ and slide the seat into the desired position.
- ▶ Make sure that the seat is engaged.

Adjusting the front seat manually and electrically (with Seat Comfort Package)

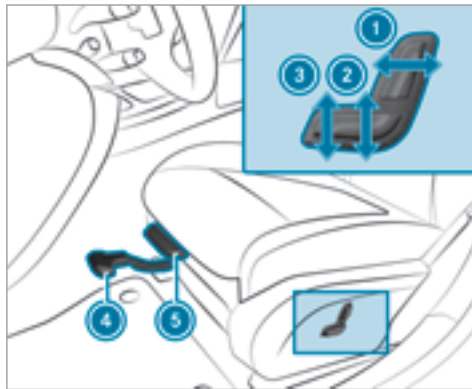

- ① Seat backrest inclination
- ② Seat height
- ③ Seat cushion inclination
- ④ Seat fore-and-aft position
- ⑤ Seat cushion length

- ▶ **To adjust the seat fore-and-aft position:** lift lever ④ and slide the seat forwards or backwards.
- ▶ Make sure that the seat is engaged.
- ▶ **To adjust the seat cushion length:** lift lever ⑤ and slide the front section of the seat cushion forwards or backwards.

Adjusting the seats electrically

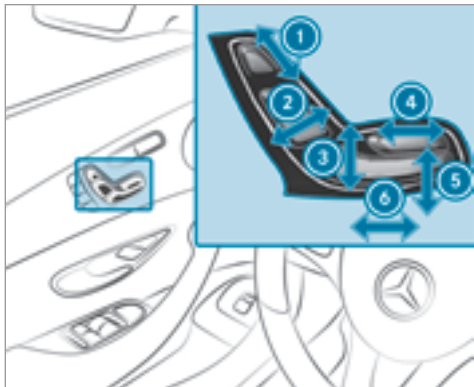

- ① Head restraint height
- ② Seat backrest inclination
- ③ Seat height
- ④ Seat cushion length
- ⑤ Seat cushion inclination
- ⑥ Seat fore-and-aft position

- ▶ Save the settings with the memory function (→ page 91).

Adjusting the front passenger seat from the driver's seat

Requirement:

- Power supply switched on

This function is only available on vehicles with an electrically adjustable front passenger seat.

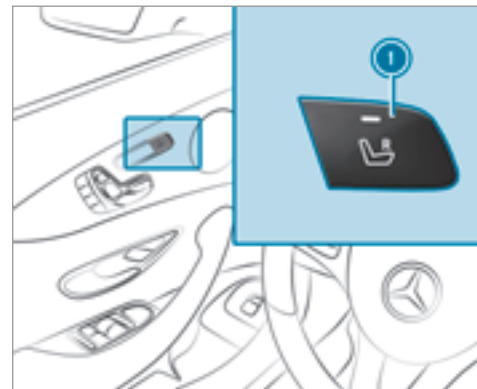

You can call up the following functions for the front passenger seat:

- Seat adjustment
- Seat heater
- Seat ventilation
- Memory function

- ▶ Press button ❶ repeatedly until the indicator lamp in the button lights up. The front passenger seat is selected.
- ▶ Adjust the front passenger seat using the buttons in the door control panel on the driver's side.

Adjusting the 4-way lumbar support

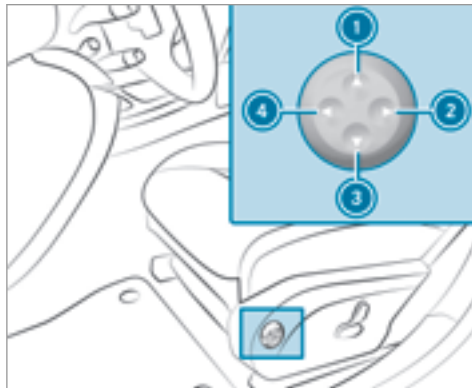

- ❶ To raise
- ❷ To soften
- ❸ To lower
- ❹ To harden

- ▶ Using buttons ❶ to ❹, adjust the contour of the backrest individually to suit your back.

Head restraints

Adjusting the front seat head restraints manually

⚠ WARNING Risk of injury from adjusting the vehicle settings while the vehicle is in motion

You could lose control of the vehicle in the following situations:

- if you adjust the driver's seat, the head restraint, the steering wheel or the mirror while the vehicle is in motion
- if you fasten your seat belt while the vehicle is in motion

- ▶ Before starting the engine: adjust the driver's seat, the head restraint, the steering wheel or the mirror and fasten your seat belt.

⚠ WARNING Risk of injury due to head restraints which are not installed or are adjusted incorrectly

If head restraints are not installed or are adjusted incorrectly, the head restraints cannot provide protection as intended.

There is an increased risk of injury in the head and neck area, e.g. in the event of an accident or when braking.

- ▶ Always drive with the head restraints installed.
- ▶ Before driving off, make sure for every vehicle occupant that the center of the head restraint supports the back of the head at about eye level.

Do not interchange the head restraints of the front and rear seats. Otherwise, you cannot adjust the height and angle of the head restraints correctly.

Adjust the head restraint fore-and-aft position so that it is as close as possible to the back of your head.

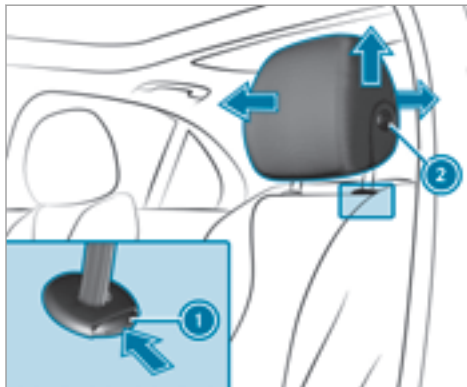

- ▶ **To raise:** pull the head restraint up.
- ▶ **To lower:** press release knob ① in the direction of the arrow and push the head restraint down.

Adjusting the gap between the head restraint and the back of your head:

- ▶ **To move forward:** pull the head restraint forward.

- ▶ **To move back:** press release knob ② and push the head restraint back.

Adjusting the front seat luxury head restraints

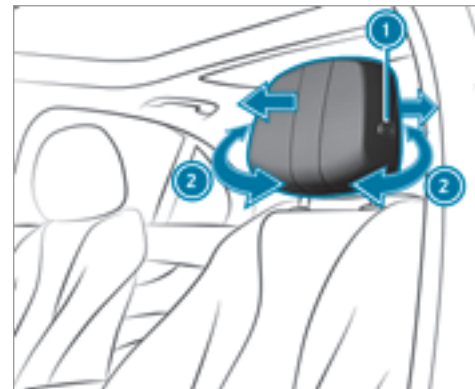

- ▶ **To adjust the side bolsters of the head restraint:** pull or push right or left-hand side bolster ②.

Adjusting the gap between the head restraint and the back of your head:

- ▶ **To move forward:** pull the head restraint forward.
- ▶ **To move back:** press release knob ❶ and push the head restraint back.

Lowering the rear seat head restraints from the front



- ▶ Press button ❶.

Adjusting the rear seat head restraints

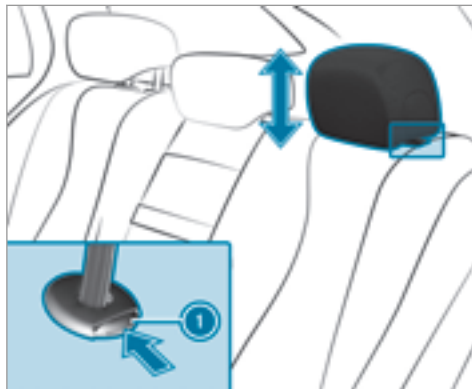

- ▶ **To raise:** pull the head restraint up.
- ▶ **To lower:** press release knob ❶ in the direction of the arrow and push the head restraint down.

Only the outer head restraints can be removed.

- ▶ Release the rear seat backrest and fold it slightly forwards.
- ▶ **To remove:** pull the head restraint up to the stop.
- ▶ Push release knob ❶ in the direction of the arrow and pull out the head restraint.
- ▶ **To install:** insert the head restraint so that the notches on the bar are on the left when viewed in the direction of travel.
- ▶ Push the head restraint down until it engages.
- ▶ Fold the rear seat backrest back until it engages.

Switching the seat heating on/off

⚠ WARNING Risk of burns due to repeatedly switching on the seat heater

Repeatedly switching on the seat heater can cause the seat cushion and seat backrest padding to become very hot.

The health of persons with limited temperature sensitivity or a limited ability to react to excessively high temperatures may be affected or they may even suffer burn-like injuries.

- ▶ Do not repeatedly switch on the seat heater.

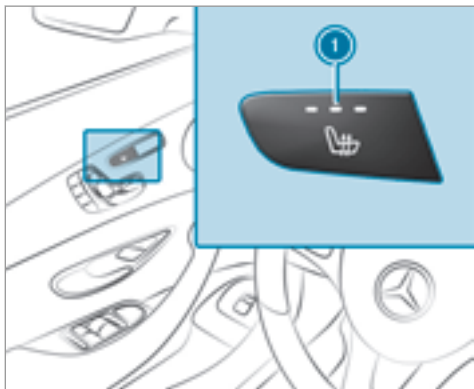

- ▶ **To switch on/increase the level:** press button ① repeatedly until the desired heating level is set.

Depending on the heating level, up to three indicator lamps light up.

- ▶ **To switch off/reduce the level:** press button ① repeatedly until all the indicator lamps go out.

- ① The seat heater automatically switches down from the three heating levels after certain periods of time: 8, 10 and 20 minutes until the seat heater is switched off.

Switching the seat ventilation on/off

Requirement:

- Power supply switched on

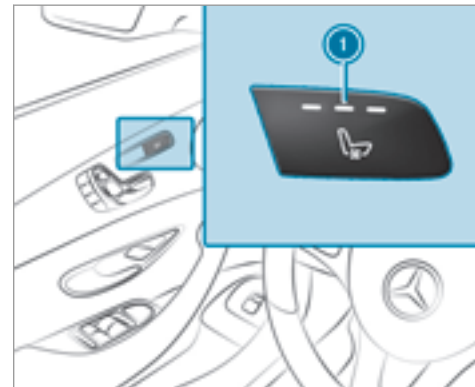

- ▶ **To switch on/increase the level/ decrease the level:** press button ① repeatedly until the desired ventilation level is set. Depending on the ventilation level, up to three indicator lamps light up.

- ▶ **To switch off:** press button ① repeatedly until all the indicator lamps go out.

Folding bench seat in the cargo compartment

Notes on the folding bench seat

⚠ WARNING Risk of injury when the seat backrest is not upright and locked in position

If the seat backrests of the rear bench seat are not locked in the upright position, the seat backrest of the folding bench seat may fold down while driving.

In this case, the seat belts may not perform their intended protective function.

▶ Make sure that the seat backrests of the rear bench seat are locked in the upright position.

Observe the notes on "Seat belts" (→ page 32), "Head restraints" (→ page 82) and "Children in the vehicle" (→ page 41).

The folding bench seat is only approved for use with child seats designed for children up to six years old .

A switch to open the tailgate from the folding bench seat is located on the wheel arch, on the right-hand side when viewed in the direction of travel.

You can obtain information on child restraint systems on the folding bench seat from any authorized Mercedes-Benz Center.

The folding bench seat may only be used when the combined cargo cover and net is installed.

Folding out the folding bench seat

Requirements:

- The seat backrests of the rear bench seat are locked in the upright position.
- The handle of the combined luggage cover and net has been moved up and, to improve the rear view, the upper part of the plate has been folded down.



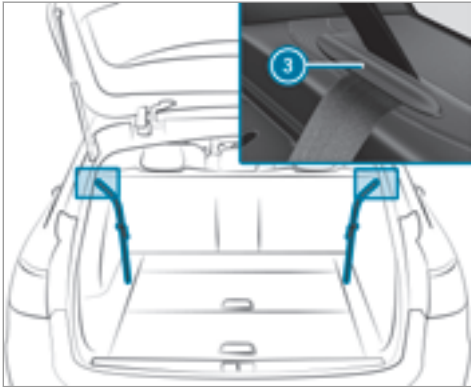

- ▶ Pull release handle ① and fold the seat backrest of the folding bench seat upwards.
- ▶ Hook the seat belts into retainers ③.
- ▶ Secure the seat belt buckles in the back of the seat backrest.
- ▶ Pull release ② and fold the seat cushion of the folding bench seat into the seat position.

- ▶ Push down the seat cushion until the seat backrest engages fully.
- ▶ Fold the head restraints upwards.

Installing and removing the seat cushion

You must remove the seat cushion on the folding bench seat beforehand if you wish to lift the cargo compartment floor in the event of a flat tire, for example.

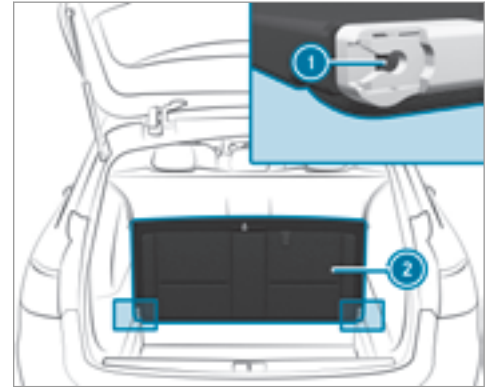



- ▶ **To remove:** fold seat cushion ② vertically upwards and remove it from seat cushion guide ①.
- ▶ **To install:** push seat cushion ② into seat cushion guide ① at a slight angle from the rear ③.
- ▶ Fold seat cushion ② back into its starting position ④ until it engages.

Folding back the folding bench seat

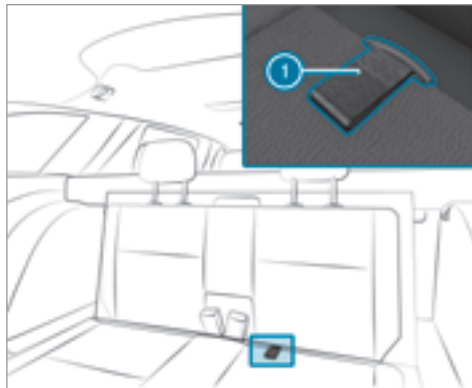

- ▶ Pull the seat cushion upwards by tab ① and fold it back into its starting position until it engages.

! **NOTE** Damage to the folding bench seat when folding back

The folding bench seat may be damaged when it is folded back.

- ▶ Fully insert the head restraints into the guides.
- ▶ Make sure that the seat belt buckles engages in their guides.

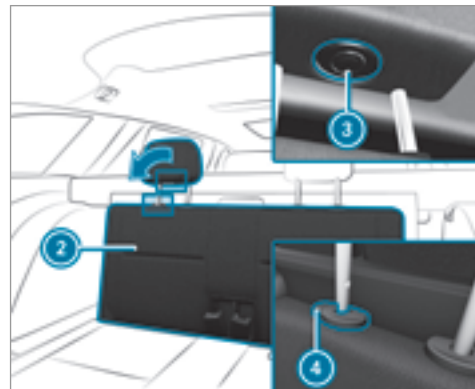

- ▶ Press release knob ③ and fold the head restraints down.
- ▶ Press release knob ④ and push the head restraints all the way in.
- ▶ Fold back seat backrest ② of the folding bench seat into its starting position.

Steering wheel

Adjusting the steering wheel manually

⚠ WARNING Risk of injury from adjusting the vehicle settings while the vehicle is in motion

You could lose control of the vehicle in the following situations:

- if you adjust the driver's seat, the head restraint, the steering wheel or the mirror while the vehicle is in motion
 - if you fasten your seat belt while the vehicle is in motion
- ▶ Before starting the engine: adjust the driver's seat, the head restraint, the

steering wheel or the mirror and fasten your seat belt.

⚠ WARNING Risk of entrapment for children when adjusting the steering wheel

Children could injure themselves if they adjust the steering wheel.

- ▶ Never leave children unattended in the vehicle.
- ▶ When leaving the vehicle, always take the SmartKey with you and lock the vehicle.

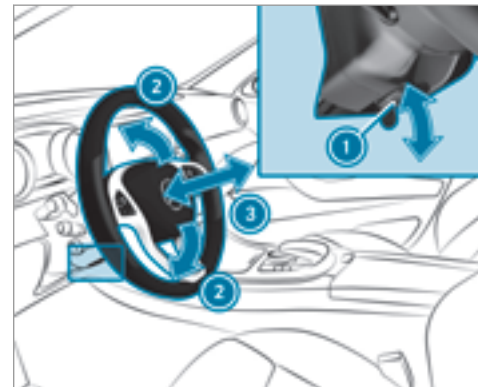

- ▶ **To unlock the steering column:** push release lever ① down completely.
- ▶ Adjust height ② and distance to steering wheel ③.
- ▶ **To lock the steering column:** push release lever ① up as far as it will go.
- ▶ Check and make sure that the steering column is locked by moving the steering wheel.

Adjusts the steering wheel electrically

The steering wheel can be adjusted when the ignition is switched off.

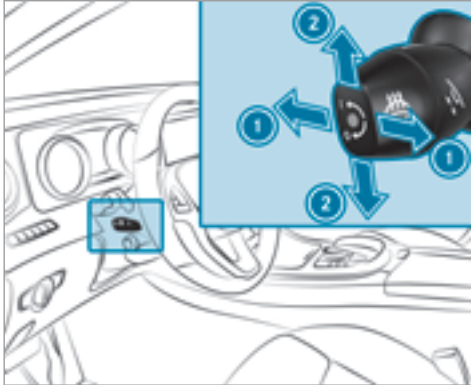

- ① Adjusts the distance to the steering wheel
- ② Adjusts the height
- ▶ Save the settings with the memory function.

Switching the steering wheel heater on/off

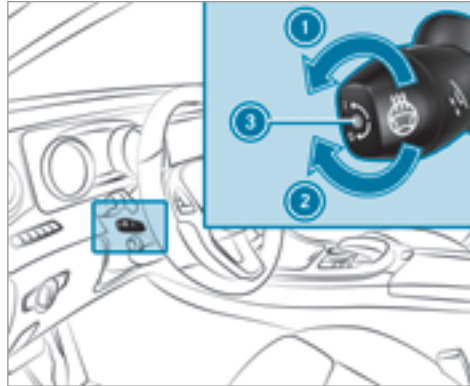

- ① To switch on
- ② To switch off
- ③ Indicator lamp

Easy entry and exit feature

How the easy entry and exit feature operates

⚠ WARNING Risk of accident when driving off while adjusting the easy exit feature

- If you drive off while the easy entry and exit feature is making adjustments, you could lose control of the vehicle.

- ▶ Always wait until the adjustment process is complete before driving off.

⚠ WARNING Risk of entrapment when adjusting the easy entry and exit feature

- When the easy entry and exit feature adjusts the steering wheel, you and other vehicle occupants – particularly children – could become trapped.

- ▶ - While the easy entry and exit feature is making adjustments, make sure that no one has any body parts in the sweep of the steering wheel.

- ▶ Move the adjustment lever of the steering wheel if there is a risk of becoming trapped by the steering wheel. The adjustment process is stopped.
- ▶ Never leave children unattended in the vehicle.
- ▶ When leaving the vehicle, always take the key with you and lock the vehicle.

The easy entry and exit feature makes getting in and out of your vehicle easier.

If the easy entry and exit feature is active, the steering wheel will move upwards in the following situations:

- you switch the ignition off.
- you open the driver's door when the ignition is switched on.

The steering wheel moves back to the last drive position in the following cases:

- you switch the ignition on when the driver's door is closed.
- you close the driver's door when the ignition is switched on.

The last drive position of the steering wheel is stored:

- when you switch off the ignition.
- with the last setting stored using the memory function.

If you press one of the memory function position buttons, the adjustment process is stopped.

The crash-responsive exit aid only functions when the easy entry and exit feature is active.

Setting the easy entry and exit feature

Multimedia system:

 [Vehicle](#) ▶ [Vehicle Settings](#) ▶ [Easy Entry/Exit](#)

 Activate or deactivate the function.

Using the memory function

 **WARNING** Risk of an accident if memory function is used while driving

If you use the memory function on the driver's side while driving, you could lose control

of the vehicle as a result of the adjustments being made.

- ▶ Only use the memory function on the driver's side when the vehicle is stationary.

 **WARNING** Risk of entrapment when setting the seat with the memory function

When the memory function adjusts the seat or steering wheel, you and other vehicle occupants – particularly children – could become trapped.

- ▶ During the setting procedure of the memory function, ensure that no body parts are in the sweep of the seat or the steering wheel.
- ▶ If somebody becomes trapped, immediately release the memory function position button. The adjustment process is stopped.

⚠ WARNING Risk of entrapment if the memory function is activated by children

Children could become trapped if they activate the memory function, particularly when unattended.

- ▶ Never leave children unattended in the vehicle.
- ▶ When leaving the vehicle, always take the SmartKey with you and lock the vehicle. This also applies to mobile phones if the "Digital Car Key in the smartphone" function is activated via the Mercedes connect me web app.

The memory function can be used when the ignition is switched off.

Seat comfort positions for up to three people can be stored and called up using the memory function.

The following systems can be set using the memory function:

- Seat, backrest and head restraint
- Steering wheel

- Outside mirrors
- Head-up Display

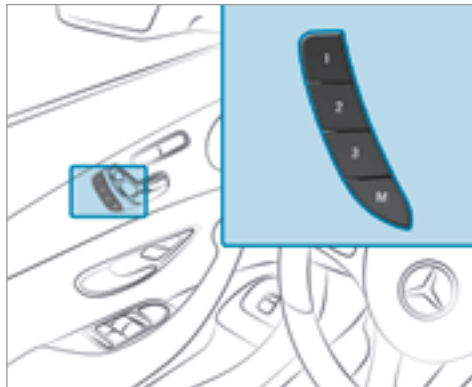

- ▶ **To save:** set the seat, the steering wheel, the Head-up Display and the outside mirrors to the desired position.

- ▶ Press the memory button M together with one of the storage position buttons 1, 2 or 3. An acknowledgment tone sounds. The settings are stored.
- ▶ **To call up:** press and hold button 1, 2 or 3 until all the seat comfort systems are in the stored position.

Stowage areas

Notes on loading the vehicle

⚠ WARNING Risk of exhaust gas poisoning

Combustion engines emit poisonous exhaust gases such as carbon monoxide. Exhaust gases can enter the vehicle interior if the tailgate is open when the engine is running, especially if the vehicle is in motion.

- ▶ Always switch off the engine before opening the tailgate.
- ▶ Never drive with the tailgate open.

⚠ WARNING Risk of injury from unsecured items in the vehicle

If objects, luggage or loads are not secured or not secured sufficiently, they could slip, tip over or be thrown around and thereby hit vehicle occupants.

There is a risk of injury, particularly in the event of sudden braking or a sudden change in direction.

- ▶ Always stow objects in such a way that they cannot be thrown around.
- ▶ Before the journey, secure objects, luggage or loads against slipping or tipping over.

⚠ WARNING Risk of injury due to objects being stowed incorrectly

If objects in the vehicle interior are stowed incorrectly, they can slide or be thrown around and hit vehicle occupants. In addition, cup holders, open stowage spaces and mobile phone brackets cannot always retain all objects they contain.

There is a risk of injury, particularly in the event of sudden braking or a sudden change in direction.

- ▶ Always stow objects so that they cannot be thrown around in such situations.
- ▶ Always make sure that objects do not protrude from stowage spaces, luggage nets or stowage nets.
- ▶ Close the lockable stowage spaces before starting a journey.
- ▶ Stow and secure objects that are heavy, hard, pointed, sharp-edged, fragile or too large in the cargo compartment.

⚠ WARNING Risk of burns from tailpipes and tailpipe trim

The tailpipe and tailpipe trim can become very hot. If you come into contact with these parts of the vehicle, you could burn yourself.

- ▶ Always be particularly careful around the tailpipe and the tailpipe trim.

- ▶ Allow the vehicle parts to cool down before you touch them.

The handling characteristics of your vehicle are dependent on the distribution of the load within the vehicle. You should bear the following in mind when loading the vehicle:

- never exceed the permissible gross mass or the permissible axle loads for the vehicle (including occupants). The values are specified on the vehicle identification plate on the vehicle's B-pillar.
- the load must not protrude above the upper edge of the seat backrests.
- when transporting objects in the cargo compartment, the combined cargo cover and net must always be installed (cargo compartment cover and safety net).
- always place the load behind unoccupied seats if possible.
- secure the load using the tie-down eyes and distribute the load evenly.

Interior stowage compartments

Overview of the front stowage compartments

Observe the notes on loading the vehicle (→ page 92).



- ① Stowage compartment in the doors
- ② Stowage/telephone compartment in the armrest with multimedia connections and stowage compartment, for example, for an MP3 player

- ③ Stowage compartment in the front center console with a USB port (depending on the vehicle's equipment)
- ④ Glove box

Locking/unlocking the glove box

Observe the notes on loading the vehicle (→ page 92).

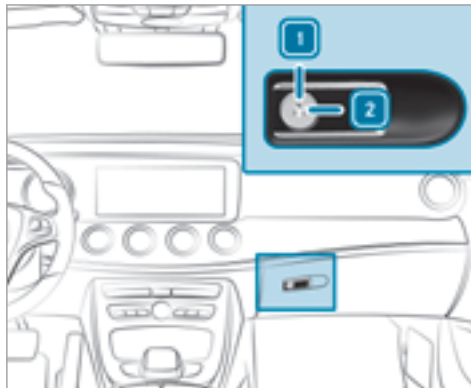

- ▶ Turn the mechanical key a quarter turn clockwise ② (to lock) or counter-clockwise ① (to unlock).

Opening the eyeglasses box

Observe the notes on loading the vehicle (→ page 92).



- ▶ **To open:** press button ①.

Opening the stowage compartment in the rear armrest

Observe the notes on loading the vehicle (→ page 92).

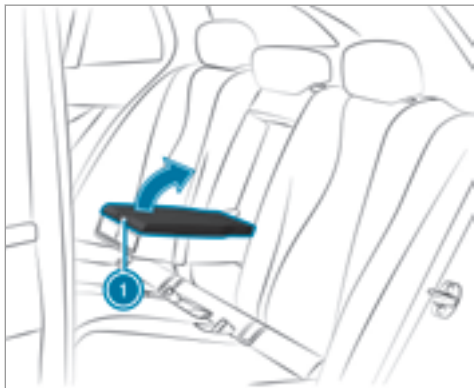

- ▶ **To open:** press release catch ① and swing the cover of the armrest upwards.

Through-loading feature in the rear bench seat

Folding the rear seat backrests forward

⚠ WARNING Risk of injury if the rear bench seat/rear seat and seat backrest are not engaged

If the rear bench seat/rear seat and seat backrest are not engaged they could fold forwards, e.g. when braking suddenly or in the event of an accident.

- If this is the case, the vehicle occupant would be forced into the seat belt by the rear bench seat/rear seat or by the seat backrest. The seat belt cannot protect as intended and could result in additional injury.
 - Objects or loads in the trunk/cargo compartment cannot be restrained by the seat backrest.
- ▶ Make sure that the seat backrest and the rear bench seat/rear seat are engaged before every trip.

If the seat backrest is not engaged and locked, this will be shown in the multifunction display in the instrument cluster.

The center and outer seat backrests can be folded forward separately.

The right outer seat backrest can only be folded forward together with the center seat backrest.

The outer seat backrests are electrically unlocked with the release handles in either the cargo compartment or beside the seat backrests.

- ▶ Fully insert the rear seat backrest head restraints.

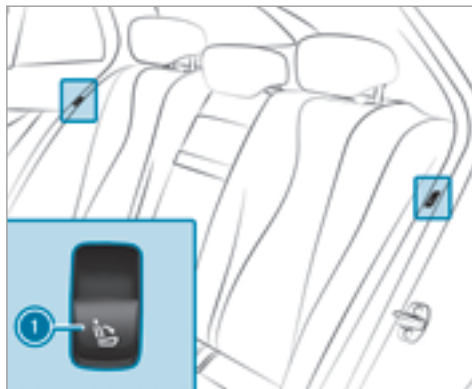

- ▶ **Left and right and seat backrests:** press right or left button ①. The corresponding seat backrest folds forward.

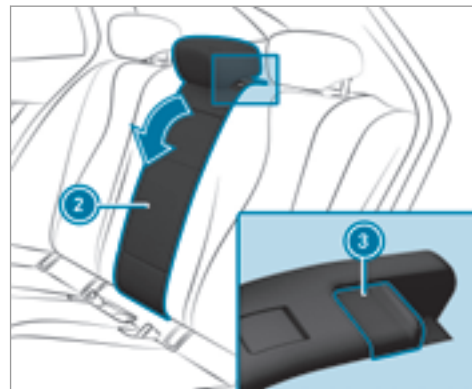

- ▶ **Center seat backrest:** pull seat backrest ② release ③ forward.
- ▶ Fold seat backrest ② forward.

Folding the rear seat backrest back

! NOTE Damage to the seat belt

The seat belt could become trapped and thus damaged when folding back the seat backrest.

- ▶ Make sure that the seat belt is not trapped when folding back the seat backrest.

If the seat backrest is not engaged and locked, this will be shown in the multifunction display in the instrument cluster.

- ▶ Move the driver's or front passenger seat forwards, if necessary.

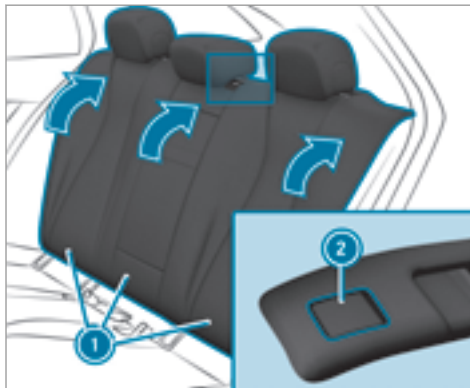

- ▶ Fold corresponding seat backrest ① back until it engages.

Left and right seat backrests: if the seat backrest is not correctly engaged, this will be shown in the multifunction display in the instrument cluster.

Center seat backrest: if the seat backrest is not correctly engaged, red lock verification indicator ② will be visible.

Locking the center rear seat backrest

Lock the center seat backrest if you want to secure the cargo compartment from unauthorized access. The center seat backrest can then only be folded forward together with the left seat backrest.

Both seat backrests must be engaged and joined together.

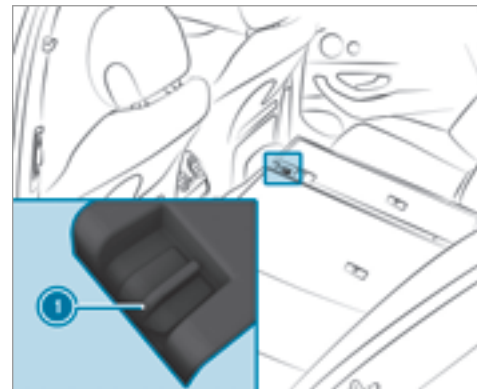

- ▶ Fold the center and left seat backrest forward.
- ▶ **To lock:** slide catch ① up. The release mechanism of the center seat backrest is locked.
- ▶ **To unlock:** slide catch ① down.

Adjusting the angle of the rear seat backrests (cargo position)

To enlarge the cargo compartment, you can adjust the seat backrests so that they are 10 degrees steeper (cargo position).

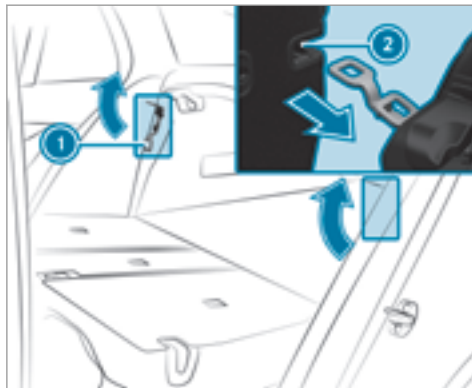

- ▶ Fold the seat backrest forward (→ page 95).
- ▶ Move bar ① in the direction of the arrow.
- ▶ Push seat backrest ② back to bar ① until the backrest engages.

Load compartment cover with safety net (combined cargo cover and net)

Notes on the cargo compartment cover

⚠ WARNING Risk of injury due to poorly secured objects

On its own, the cargo compartment cover cannot secure or restrain heavy objects, items of luggage or heavy loads.

You could be hit by an unsecured load during sudden changes in direction, braking or in the event of an accident. There is an increased risk of injury or even fatal injury.

- ▶ Always stow objects in such a way that they cannot be thrown around.
- ▶ Secure objects, luggage or loads against slipping or tipping over, e.g. by using lashing material, even if you are using the cargo compartment cover.

! **NOTE** Damage to the cargo compartment cover when loading the vehicle

The cargo compartment cover may be damaged when loading the vehicle.

▶ Do not place any objects above the lower edge of the side windows or on the cargo compartment cover.

The cargo compartment cover and the safety net form the combined luggage cover and net.

When the cargo compartment cover is clipped in, no objects in the cargo compartment should obstruct the downwards movement of the cover when the tailgate is closed. The cargo compartment cover will otherwise be raised again automatically.

Extending/retracting the cargo compartment cover



▶ **To extend:** pull cargo compartment cover ① back by grab handle ② and clip it into the brackets on the left and right.

The cargo compartment cover raises automatically when the tailgate is opened and lowers again when the tailgate is closed.

▶ **To retract:** unhook cargo compartment cover ① from the brackets on the left and right and guide it forwards by grab handle ② until it is fully retracted.

The contour plate of the retracted cargo compartment cover can be used in three positions:

- folded up by 45° (loading position)
- horizontal position (driving position)
- folded down and locked in place (rattle-free position when driving)

Installing/removing the combined luggage cover and net

Requirements

- Remove from the cargo compartment or from the left-hand rear door if the seat backrests are folded forwards.
- The cargo compartment cover and safety net are retracted.

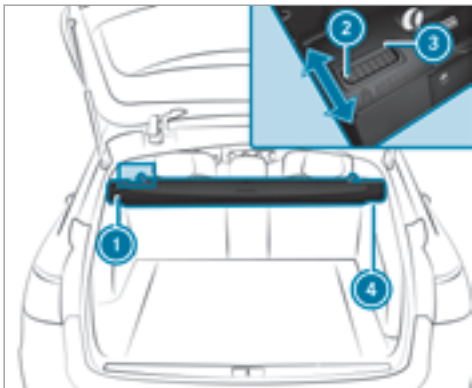

- ▶ **To remove:** press button ②.
- ▶ Fold the combined luggage cover and net backwards with the seat backrest folded up.
- ▶ First, detach the combined luggage cover and net from left-hand catch ① and then remove it from right-hand bracket ④.

- ▶ **To install:** slide the combined luggage cover and net into right-hand bracket ④ up to the stop.
- ▶ Place the combined luggage cover and net into the left-hand bracket and slide it into catch ① until the combined luggage cover and net engages audibly. Red lock verification indicator ③ must no longer be visible.

Attaching the combined luggage cover and net to the rear seat backrest

! **NOTE** Damage to the combined luggage cover and net when attaching it to the seat backrest

When the combined luggage cover and net is attached to the seat backrest, it may be damaged when the seat backrest is folded back.

- ▶ Do not fold the seat backrests back.

Requirement:

- The seat backrests are folded forwards.

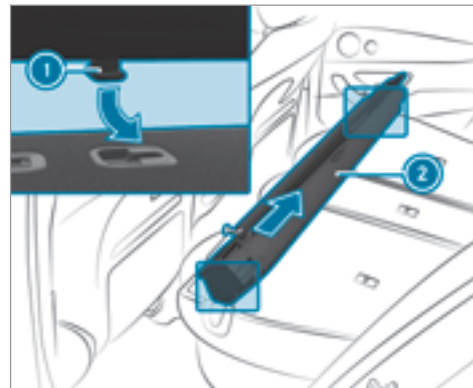

- ▶ Insert combined luggage cover and net ② into both guides ① and push it up to the stop in the direction of the arrow.

To disassemble the combined luggage cover and net, follow the instructions in reverse order.

Attaching the safety net

⚠ WARNING Risk of injury due to poorly secured objects

On its own, the safety net cannot secure or restrain heavy objects, items of luggage or heavy loads.

You could be hit by an unsecured load during sudden changes in direction, braking or in the event of an accident. There is an increased risk of injury or even fatal injury.

- ▶ Always stow objects in such a way that they cannot be thrown around.
- ▶ Secure objects, luggage or loads against slipping or tipping over, e.g. by using lashing material, even if you are using the safety net.

For safety reasons, always use a safety net when transporting a load.

Damaged safety nets can no longer fulfill their protective functions and must be replaced. Visit a qualified specialist workshop.

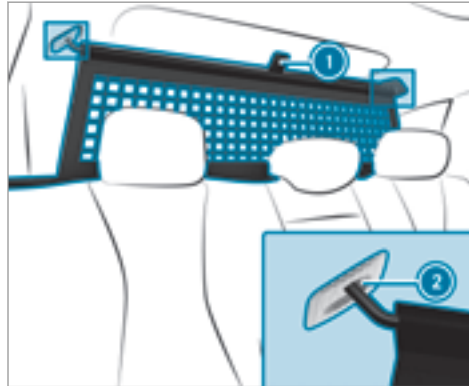

- ▶ **Safety net without cargo compartment enlargement:** pull the safety net back from the rear bench seat by tab ①.
- ▶ Hook the safety net first on the left, then on the right into eyelets ②.

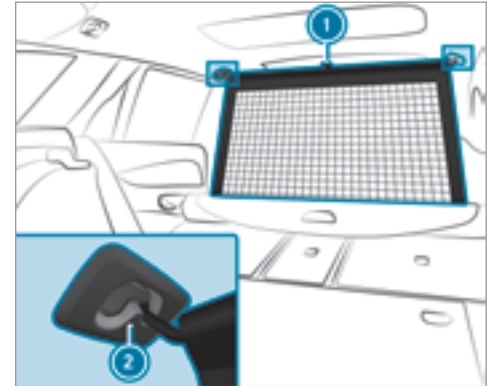

- ▶ **Safety net with cargo compartment enlargement:** guide the safety net up by tab ① and hook it into eyelets ②.

Overview of the tie-down eyes

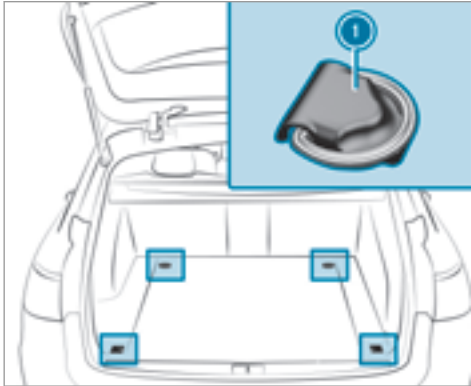

① Tie-down eyes

Related topic:
Loading guidelines (→ page 92).

Overview of bag hooks

⚠ WARNING Risk of injury when using bag hooks with heavy objects

The bag hooks cannot restrain heavy objects or items of luggage.

Objects or items of luggage could be thrown around and thereby hit vehicle occupants when braking or abruptly changing directions.

- ▶ Only hang light objects on the bag hooks.
- ▶ Never hang hard, sharp-edged or fragile objects on the bag hooks.

The bag hook can bear a maximum load of 6.6 lbs (3 kg). Do not use it to secure a load.

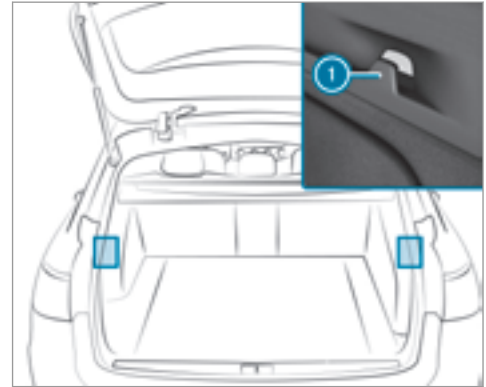

① Bag hook

Related topic:
Loading guidelines (→ page 92).

EASY-PACK load-securing kit

Notes on the EASY-PACK load-securing kit

The EASY-PACK load-securing kit allows you to use your cargo compartment for a variety of purposes. The components are located under the cargo compartment floor.

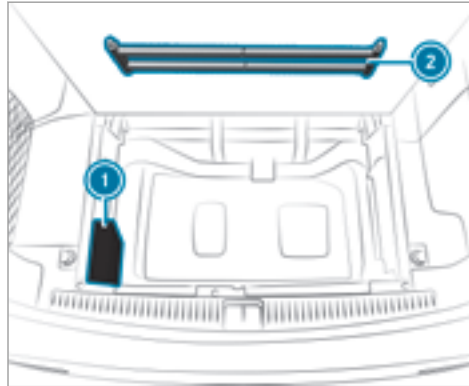

- ① Bag containing the brackets and luggage holder
- ② Telescopic rod

Inserting the brackets into the load rail

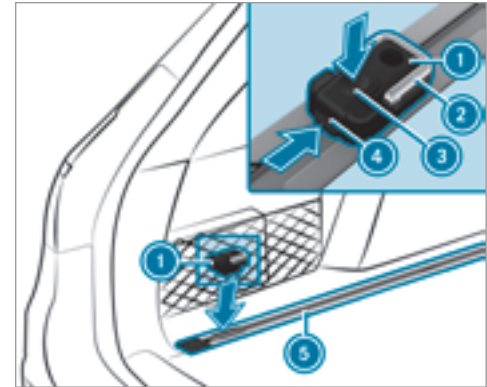

- ▶ Insert bracket ① into the center of load rail ⑤.
- ▶ Press release knob ③ and slide bracket ① into the desired position in load rail ⑤.
- ▶ Let go of release knob ③.
- ▶ Press locking button ④. Bracket ① is locked in load rail ⑤.

- ▶ If necessary, fold tie-down eye ② upwards.

Tensioning the luggage holder

Requirements:

- The luggage holder is used to secure loads against the side wall of the cargo compartment to prevent them from moving around.
- Only secure loads with a maximum weight of 15.4 lbs (7 kg) and which are small enough for the luggage holder to tightly and properly secure them.

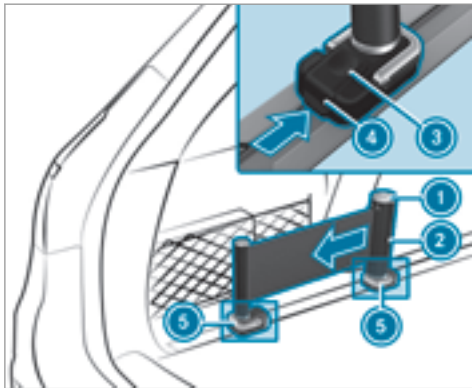

- ▶ **To install:** insert two brackets ⑤ into the left or right load rail.
- ▶ Press release knob ① of luggage holder ② and pull the strap out slightly.
- ▶ Insert luggage holder ② into brackets ⑤ and, while doing so, press release knob ③ and slide the luggage holder downwards until it engages.

- ▶ Press release knob ① of the luggage holder and pull the strap out in the direction of the arrow.
- ▶ Place the load between the strap and the cargo compartment side wall.
- ▶ Using one hand, press release knob ① of the luggage holder.
- ▶ With your other hand, let the strap go slowly until the load is secured.
- ▶ Make sure that locking button ④ on brackets ⑤ is pressed. Brackets ⑤ are secured in place on the load rail.
- ▶ **To remove:** press release knob ③ on respective bracket ⑤ and remove luggage holder ② by pulling upwards and out.

Tensioning the telescopic rod

Requirement:

The telescopic rod is used to secure loads against the rear seats to prevent them from moving around.

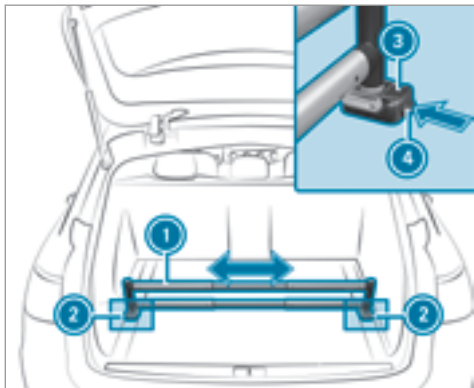

- ▶ **To install:** insert one bracket ② into both the left and right load rails and slide it to the desired position.
- ▶ Insert telescopic rod ① into brackets ②.
- ▶ When doing so, press release knob ③ and slide telescopic rod ① down until it engages.

- ▶ Make sure that locking button ④ on brackets ② is pressed. Brackets ② are secured in place on the load rail.
- ▶ **To remove:** press release knob ③ on respective bracket ② and remove telescopic rod ① by pulling it up and out.

Opening the stowage space under the cargo compartment floor

⚠ WARNING Risk of injury due to an open cargo compartment floor

If you drive when the cargo compartment floor is open, objects could be thrown around and thereby strike vehicle occupants. There is a risk of injury, particularly in the event of sudden braking or a sudden change in direction.

- ▶ Always close the cargo compartment floor before a journey.

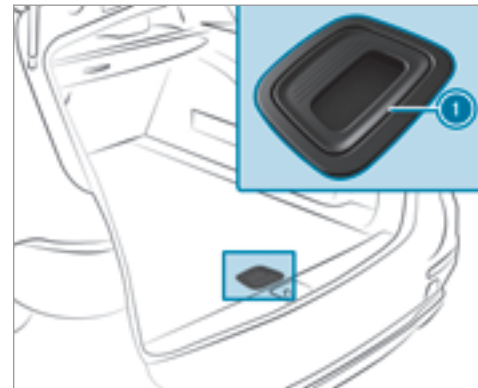

- ▶ **To open:** holding the ribbing, press handle ① down.
- ▶ Lift the cargo compartment floor up by handle ①.
- ▶ Fold out the hook on the strap on the underside of the cargo compartment floor and hook it into the rain trough.

- ▶ **To close:** unhook the hook from the rain trough and fasten it to the bracket on the underside of the cargo compartment floor.
- ▶ Fold the cargo compartment floor down and then press handle ① down until it engages.

Attaching the roof rack

⚠ WARNING Risk of injury by exceeding the maximum roof load

When you load the roof, the vehicle center of gravity rises and the driving characteristics change.

If you exceed the maximum roof load, the driving characteristics, as well as the steering and braking, will be greatly impaired.

- ▶ Never exceed the maximum roof load and adjust your driving style.

You will find information on the maximum roof load in the "Technical data" section.

Requirements

- Only use roof racks tested and approved by Mercedes-Benz.
 - Make sure that you can raise the sliding sunroof fully and open the tailgate fully once the roof rack is installed.
 - The panoramic sliding sunroof cannot be opened if a roof rack is installed. The panoramic sliding sunroof closes again automatically when it encounters resistance.
- ▶ Secure the roof rack to the roof railing.
 - ▶ Observe the manufacturer's installation instructions.

Cup holder

Installing or removing the cup holder in the center console

⚠ WARNING - Risk of accident or injury when using the cup holder while the vehicle is moving

The cup holder cannot secure containers while the vehicle is moving.

If you use a cup holder while the vehicle is moving, the container may be flung around and liquids may be spilled. The vehicle occupants may come into contact with the liquid and if it is hot, they could be scalded. You could be distracted from traffic conditions and you may lose control of the vehicle.

- ▶ Only use the cup holder when the vehicle is stationary.
- ▶ Only use the cup holder for containers of the right size.
- ▶ Close the container, particularly if the liquid is hot.

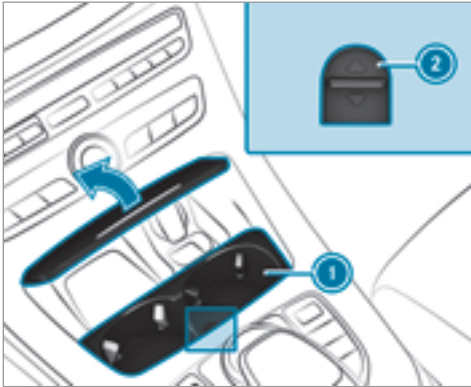

▶ **To remove:** slide catch ② forwards and pull out cup holder ①.

▶ **To install:** insert cup holder ① and slide back catch ②.

ⓘ The rubber mat of the cup holder can be removed for cleaning, e.g. using clean, luke-warm water.

Opening the cup holder in the rear armrest

! **NOTE** Damage to the cup holder

When the rear armrest is folded back the cup holder could become damaged.

▶ Only fold the rear armrest back when the cup holder is closed.

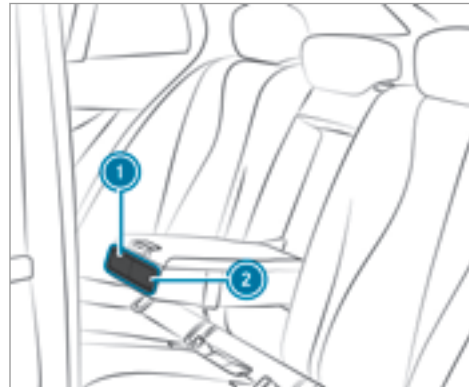

▶ **To open:** press on cup holder ① or ②.

▶ **To fold in or out:** place or remove a container from cup holder ① or ②.

Ashtray and cigarette lighter

Using the ashtray in the front center console

! **NOTE** Damage to the stowage compartment under the ashtray

The stowage compartment under the ashtray is not heat resistant and could be damaged if you rest a lit cigarette on it.

▶ Make sure that the ashtray is fully engaged.

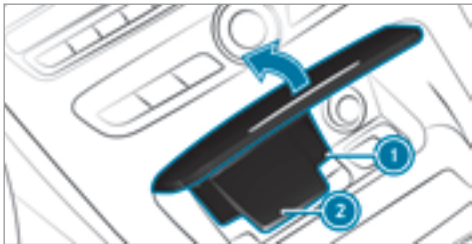

- ▶ **To open:** push the cover of the ashtray upwards on its right ② or left side.
- ▶ **To remove the insert:** press insert ① upwards slightly and pull it out upwards.
- ▶ **To install the insert:** press insert ① into the holder until the insert engages.

Using the rear passenger compartment ashtray

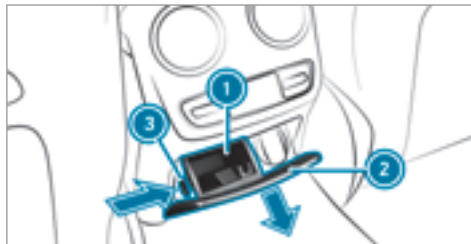

- ▶ **To open:** pull cover ② out by its top handle edge.
- ▶ **To remove the insert:** push ribbing ③ from the left side and pull insert ① upwards and out.
- ▶ **To install the insert:** install insert ① from above and press down into the holder until it engages.

Using the cigarette lighter

⚠ WARNING - Risk of fire and injury from hot cigarette lighter

You can burn yourself if you touch the hot heating element or the socket of the cigarette lighter.

In addition, flammable materials may ignite if:

- you drop the hot cigarette lighter
- a child holds the hot cigarette lighter to objects, for example
- ▶ Always hold the cigarette lighter by the knob.
- ▶ Always make sure that the cigarette lighter is out of reach of children.
- ▶ Never leave children unattended in the vehicle.

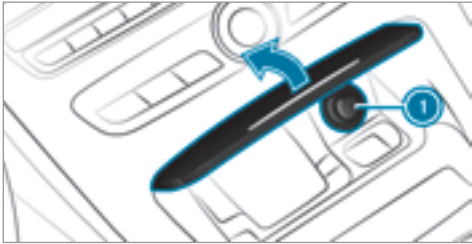

- ▶ Press in cigarette lighter ①. The cigarette lighter will pop out automatically when the heating element is red-hot.

Sockets

Using the 12 V socket in the front center console

Requirements

- Only connect devices up to a maximum of 180 Watt (15 A)
- If you have connected a device to the 12 V socket, leave the cover of the stowage compartment open



- ▶ Lift up cover ① of the socket and insert the plug of the device.

Using the 12 V socket in the rear passenger compartment

Requirement

Only connect devices up to a maximum of 180 watt (15 A)

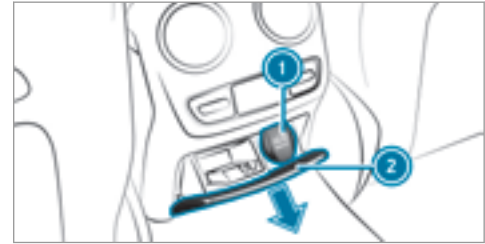

- ▶ Briefly press the trim of cover ②.
- ▶ Lift out cover ① of the socket and insert the plug of the device.

Using the 115 V socket in the rear passenger compartment

⚠ DANGER Risk of fatal injury due to damaged connecting cables or sockets

If a suitable device is connected, the 115 V socket will be carrying a high voltage. If the connecting cable or the 115 V socket is pulled out of the trim or is damaged or wet, you could receive an electric shock.

- ▶ Only use dry and damage-free connecting cables.
- ▶ When the ignition is switched off, ensure that the 115 V socket is dry.
- ▶ If the 115 V socket is damaged or gets pulled out of the paneling, immediately have the socket checked or replaced at a qualified specialized workshop.
- ▶ Never plug the connecting cable into a 115 V socket that is damaged or has been pulled out of the trim.

⚠ DANGER Risk of fatal injury due to incorrect handling of the socket

You could receive an electric shock:

- if you reach into the socket.
 - if you insert unsuitable devices or objects into the socket.
- ▶ Only connect suitable devices to the socket.

Requirements

- Only connect devices with a suitable plug which conforms to the standards specific to the country you are in.
- Only connect devices up to a maximum of 150 watts.
- Do not use multiple socket outlets.

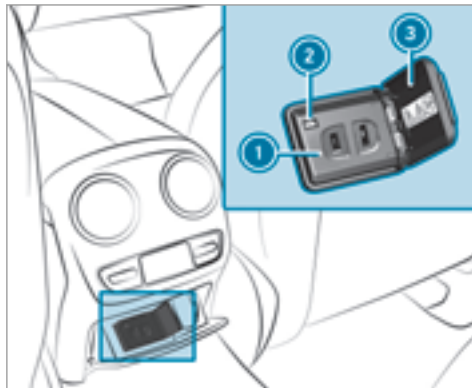

- ▶ Open flap ③.

- ▶ Insert the plug of the device into 115 V socket ①.
When the on-board electrical system voltage is sufficient, indicator lamp ② lights up.

Using the 12 V socket in the cargo compartment

Prerequisite

Only connect devices up to a maximum of 180 Watt (15 A)

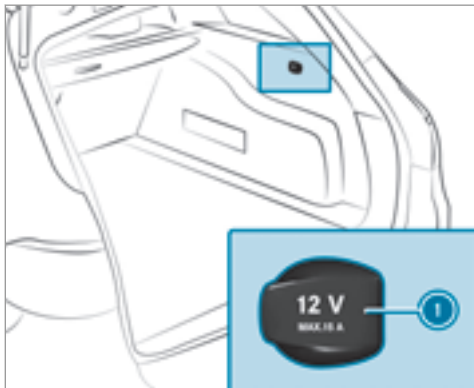

- ▶ Lift up cover ① of the socket and insert the plug of the device.

Wireless charging of the mobile phone and connection with the exterior antenna

Notes on wireless charging of the mobile phone

⚠ WARNING Risk of injury due to objects being stowed incorrectly

If objects in the vehicle interior are stowed incorrectly, they can slide or be thrown around and hit vehicle occupants. In addition, cup holders, open stowage spaces and mobile phone receptacles cannot always retain all objects they contain.

There is a risk of injury, particularly in the event of sudden braking or a sudden change in direction.

- ▶ Always stow objects so that they cannot be thrown around in such situations.
- ▶ Always make sure that objects do not protrude from stowage spaces, luggage nets or stowage nets.

- ▶ Close the lockable stowage spaces before starting a journey.
- ▶ Always stow and secure heavy, hard, pointed, sharp-edged, fragile or bulky objects in the trunk/load compartment.

Observe the notes on loading the vehicle.

⚠ WARNING Risk of fire from placing objects in the mobile phone stowage compartment

If you place objects in the mobile phone stowage compartment, they may heat up excessively and even catch fire.

- ▶ Do not place additional objects, especially those made of metal, in the mobile phone stowage compartment.

! **NOTE** Damage to objects caused by placing them in the mobile phone stowage compartment

If you place objects in the mobile phone stowage compartment, these may be damaged by electromagnetic fields.

- ▶ Do not place credit cards, storage media or other objects sensitive to electromagnetic fields in the mobile phone stowage compartment.

! **NOTE** Damage to the mobile phone stowage compartment caused by liquids

If liquid is spilled in the mobile phone stowage compartment, the mobile phone stowage compartment may be damaged.

- ▶ Do not spill liquids into the mobile phone stowage compartment.

- Depending on the vehicle equipment, the mobile phone is connected to the vehicle's exterior antenna via the charging module.

- The charging function and wireless connection of the mobile phone to the vehicle's exterior antenna are only available when the ignition is switched on.
- Small mobile phones may not be able to be charged in every position of the mobile phone stowage compartment.
- Large mobile phones which do not fit into the mobile phone stowage compartment may not be able to be charged or connected with the exterior antenna.
- The mobile phone may heat up during the charging process. The mobile phone can be cooled in the mobile phone stowage compartment when the air conditioning system is switched on. The cooling output in the mobile phone stowage compartment is highest when the controller in the glove box is closed.

Wireless charging of the mobile phone

Requirements

- Your mobile phone must be suitable for wireless charging (Qi-compatible mobile phone).

You can find a list of Qi-compatible mobile phones online at:

<http://www.mercedes-benz.com/connect>

- To ensure more efficient charging and connection with the vehicle's exterior antenna, remove the protective cover from the mobile phone.
- If possible, use the mat when charging.

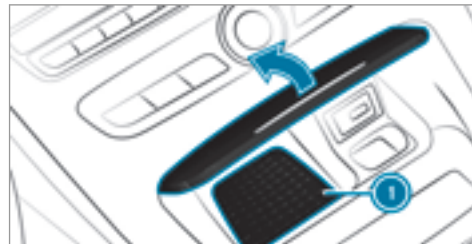

- ▶ Place the mobile phone as close as possible to the center of mat ① with the display facing up.

The mobile phone is charged automatically, as is apparent from the way in which the

mobile phone reacts and from the charging symbol in the multimedia system display.

Malfunctions during the charging process are shown in the multimedia system display.

i To clean, mat **1** can be removed.

Installing/removing floor mats

⚠ WARNING Risk of accident due to objects in the driver's footwell

Objects in the driver's footwell may impede pedal travel or block a depressed pedal.

This jeopardizes the operating and road safety of the vehicle.

- ▶ Stow all objects in the vehicle securely so that they cannot get into the driver's footwell.
- ▶ Always install the floor mats securely and as prescribed in order to ensure that there is always sufficient room for the pedals.

▶ Do not use loose floor mats and do not place floor mats on top of one another.

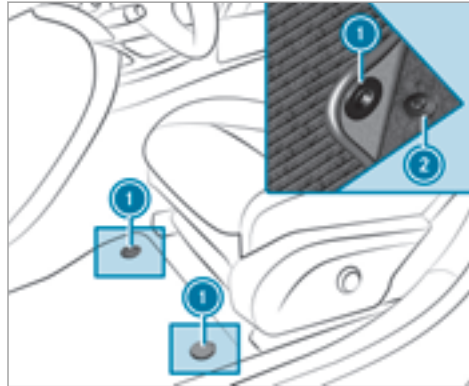

▶ **To install:** press studs **1** onto holders **2**.

▶ **To remove:** pull the floor mat off the holders **2**.

Exterior lighting

Lighting systems and your responsibility

The various lighting systems of the vehicle are only aids. The driver of the vehicle is responsible for correct vehicle illumination in accordance with the prevailing light and visibility conditions, legal requirements and traffic situation.

Light switch

Operating the light switch

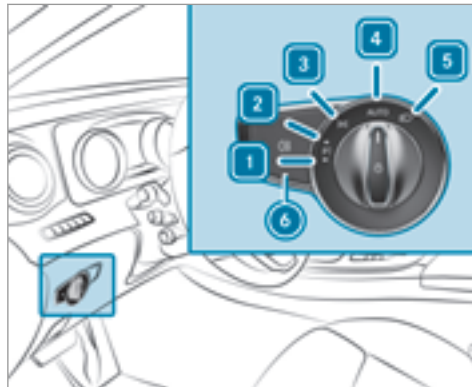

- ▶ 1 Left-hand standing lamp
- ▶ 2 Right-hand standing lamp
- ▶ 3 Parking lights and license plate lighting

- ▶ 4 **AUTO** Automatic driving lights (preferred light switch position)
- ▶ 5 Low beam/high beam
- ▶ 6 Switches the rear fog light on or off

When low beam is activated, the indicator lamp for the parking lights is deactivated and replaced by the low beam indicator lamp.

Always park your vehicle safely and in a well-lit area, in accordance with the relevant legal stipulations.

! **NOTE** Battery discharging by operating the standing lights

Operating the standing lights over a period of hours puts a strain on the battery.

- ▶ Where possible, switch on the right or left parking light.

In the case of severe battery discharging, the parking lamps or standing lamps are automatically switched off to facilitate a future engine start.

The exterior lighting (except parking and standing lamps) switches off automatically when the driver's door is opened.

Automatic headlamp mode

The parking lights, low beam and daytime running lamps are switched on or off automatically depending on the ignition status, whether the engine is running and on the ambient light.

⚠ WARNING Risk of accident when the low beam is switched off in poor visibility

When the light switch is set to **AUTO**, the low beam may not be switched on automatically if there is fog, snow or other causes of poor visibility such as spray.

▶ In such cases, turn the light switch to .

The automatic driving lights are only an aid. You are responsible for vehicle lighting.

Activating/deactivating the rear fog light

Requirement

The light switch is in the  or **AUTO** position.

▶ Press the  button.

Please observe the country-specific laws on the use of rear fog lamps.

Operating the light combination switch

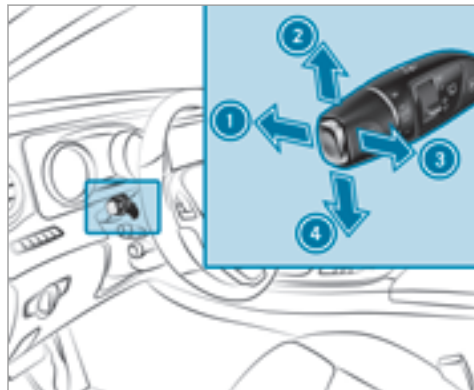

- ① High beam
- ② Turn signal light, right

- ③ High-beam flasher
- ④ Turn signal light, left

▶ Pull or push the combination switch in the relevant direction following the arrow.

Switching on the high beam manually

▶ **Vehicles with Adaptive Highbeam Assist:**

- Turn the light switch to the  position.
- Press the combination switch beyond the pressure point in the direction of arrow ①.

When the high beam is activated, the indicator lamp for low beam is deactivated and replaced by the indicator lamp for the high beam.

- ▶ **To switch off the high beam:** move the combination switch back to its starting position.
- ▶ **To indicate briefly:** press the combination switch briefly up to the pressure point in the direction of arrow ② or ④. The corresponding turn signal light flashes three times.

- ▶ **To indicate for a duration:** press the combination switch beyond the pressure point in the direction of arrow ② or ④.

Activating/deactivating the hazard warning light

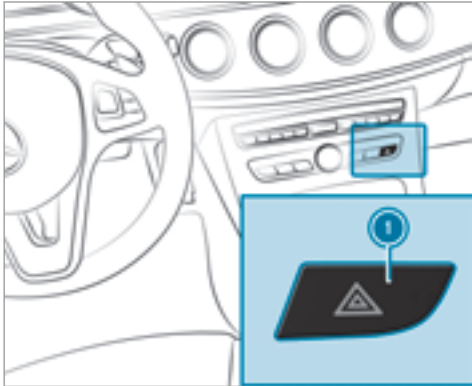

- ▶ Press button ①.

Cornering light

Cornering light function



Cornering light improves the illumination of the roadway over a wide angle in the direction you are turning, enabling better visibility in tight bends, for example. It can only be activated when the low beam is switched on.

The function is active:

- At speeds below 25 mph (40 km/h) when the turn signal light is switched on or the steering wheel is turned.

- At speeds between 25 mph (40 km/h) and 45 mph (70 km/h) when the steering wheel is turned.

Traffic circle and intersection function: The cornering light is activated on both sides through an evaluation of the current GPS position of the vehicle. It remains active until after the vehicle has left the traffic circle or the intersection.

Adaptive Highbeam Assist

Function of Adaptive Highbeam Assist

⚠ WARNING Risk of accident despite Adaptive Highbeam Assist

Adaptive Highbeam Assist does not recognize the following road users:

- Road users without lights, e.g. pedestrians
- Road users with poor lighting, e.g. cyclists
- Road users whose lighting is obstructed, e.g. by a barrier

On very rare occasions, Adaptive Highbeam Assist may fail to recognize other road users with their own lighting, or may recognize them too late.

In these or similar situations, the automatic high beam is not deactivated or is activated despite the presence of other road users.

- ▶ Always observe the traffic carefully and switch off the high beam in good time.



Adaptive Highbeam Assist switches automatically between:

- Low beam
- High beam

At speeds above 19 mph (30 km/h):

- If no other road users are detected, the high beam is automatically switched on.

The high beam switches off automatically:

- At speeds below 16 mph (25 km/h).
- If other road users are detected.
- If street lighting is sufficient.

At speeds above approx. 31 mph (50 km/h):

- The headlamp range of the low beam is regulated automatically based on the distance to other road users.

The system's optical sensor is located behind the windshield near the overhead control panel.

System limitations

Adaptive Highbeam Assist cannot take into account road, weather or traffic conditions.

Detection may be restricted if:

- Visibility is impaired, for example in fog, heavy rain or snow.
- There is dirt on the sensors or if the sensors are covered over.

Switching Adaptive Highbeam Assist on/off

- ▶ **To switch on:** turn the light switch to the **AUTO** position.

- ▶ Switch on the high beam using the combination switch.
When the high beam is switched on automatically in the dark, the  indicator lamp in the multifunction display comes on.
- ▶ **To switch off:** switch off the high beam using the combination switch.

Switching the daytime running lights on/off

Multimedia system:

↳ Vehicle ▶▶ Light ▶▶ Daytime Running Lights

- ▶ Activate or deactivate the function.

Setting the exterior lighting switch-off delay time

Prerequisite

The light switch is in the  position.

Multimedia system:

↳ Vehicle ▶▶ Light ▶▶ Exterior Lighting
Delayed Switch-off

If you switch on this function, the exterior lighting is switched on for a short time after the vehicle is switched off.

- ▶ Set the switch-off delay time.

Switching the locator lighting on/off

Multimedia system:

↳ Vehicle ▶▶ Light ▶▶ Locator Lighting

The exterior lighting remains lit for 30 seconds after the vehicle is unlocked. When you start the vehicle, the locator lighting is switched off and automatic driving lights are activated.





- ▶ Activate or deactivate the function.

Interior lighting

Adjusting the interior lighting

Front overhead control panel



- ▶ ①  Switches the front left-hand reading lamp on/off
- ▶ ②  Switches the automatic interior lighting control on/off
- ▶ ③  Switches the front interior lighting on/off
- ▶ ④  Switches the rear interior lighting on/off

- ▶ ⑤  Switches the front right-hand reading lamp on/off

Control panel in the grab handle (rear passenger compartment)



- ▶ ①  Switches the reading lamp on/off

Adjusting the ambient lighting

Multimedia system:

↳ Vehicle ▶ Light

Setting the color

- ▶ Select **Ambient Light Color**.

- ▶ Select a color.

Adjusting the brightness

- ▶ Select **Ambient Light Brightness**.
- ▶ **To set the brightness:** select the brightness value using the left-hand setting element.
- ▶ **To set the zone:** select the zone using the right-hand setting element.

Setting the interior lighting switch-off delay time

Multimedia system:



↳ Vehicle ▶ Light ▶ Interior Lighting
Delayed Switch-off

- ▶ Set the switch-off delay time.

Windshield wiper and windshield washer system

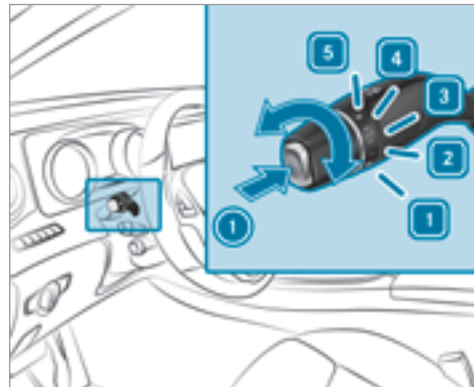
Switching the windshield wiper on/off



- ▶ ①  Single wipe /  wiping with washer fluid
- ▶ ① 0 Windshield wiper off
- ▶ ② ... Intermittent wiping, normal

- ▶ 3 Intermittent wiping, frequent
- ▶ 4 Continuous wiping, slow
- ▶ 5 Continuous wiping, fast

Switching the rear window windshield wiper on/off

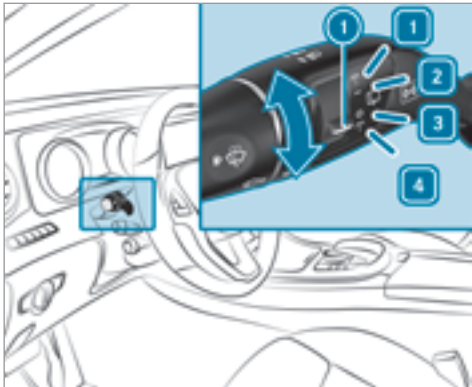

- ▶ ① Switch

- ▶ 1 Wipes with washer fluid
- ▶ 2 Switches on intermittent wiping
- ▶ 3 Switches off intermittent wiping
- ▶ 4 Wipes with washer fluid

Changing the windshield wiper blades

⚠ WARNING Risk of becoming trapped if the windshield wipers are switched on while wiper blades are being replaced

If the windshield wipers begin to move while you are changing the wiper blades, you can be trapped by the wiper arm.

- ▶ Always switch off the windshield wipers and the ignition before changing the wiper blades.

Moving the wiper arms to a vertical position

- ▶ Set the windshield wiper to the slow continuous wiping position on the combination switch.

- ▶ As soon as the wiper arms are vertical relative to the hood, switch off the ignition.
- ▶ Fold the wiper arm away from the windshield.

Removing the wiper blades

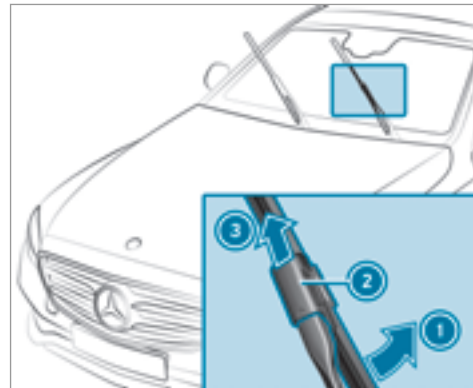

- ▶ Hold the wiper arm with one hand. With the other hand, turn the wiper blade in the direction of arrow ① away from the wiper arm to the stop.

- ▶ Slide catch ② in the direction of arrow ③ until it engages in the removal position.

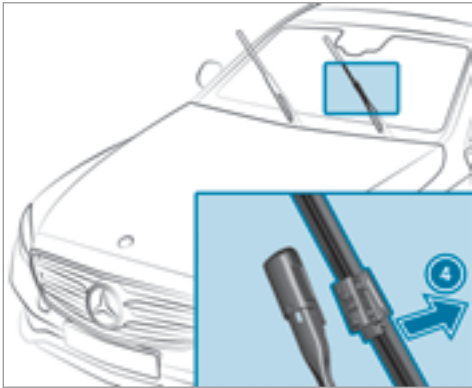

- ▶ Remove the wiper blade in the direction of arrow ④ away from the wiper arm.

Installing the wiper blades

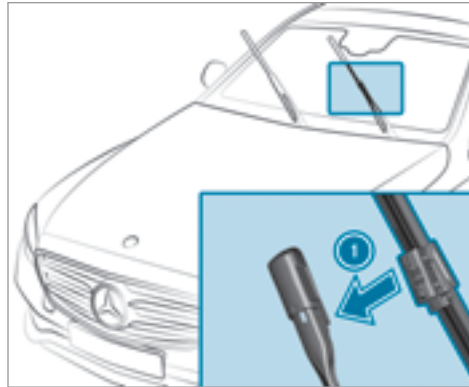

- ▶ Insert the new wiper blade into the wiper arm in the direction of arrow ①.

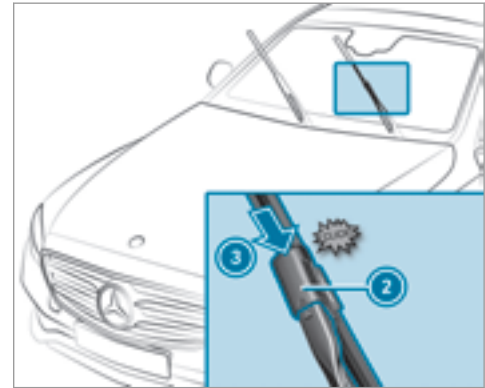

- ▶ Slide catch ② in the direction of arrow ③ until it engages in the locking position.
- ▶ Make sure that the wiper blade sits correctly.
- ▶ Fold the wiper arm back onto the windshield.

Maintenance display

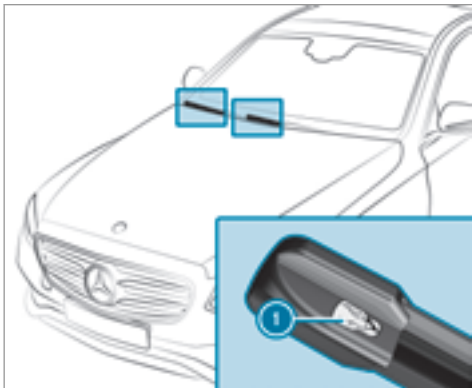

- ▶ Remove protective film ① of the maintenance display on the tip of the newly installed wiper blade.

If the color of the maintenance display changes from black to yellow, the wiper blades should be replaced.

- ⓘ The duration of the color change varies depending on the usage conditions.

Replacing the rear window wiper blades

Removing the wiper blade

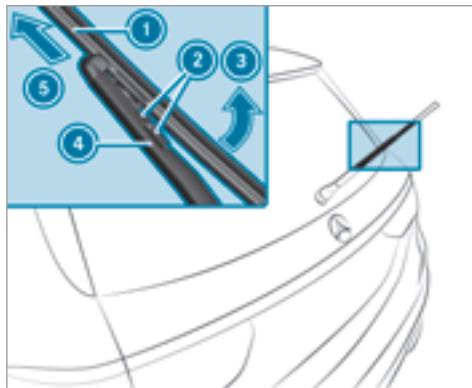

- ▶ Switch the ignition off.

- ▶ Fold wiper arm ④ away from the rear window.
- ▶ Press both release clips ②.
- ▶ Fold wiper blade ① in the direction of arrow ③ away from wiper arm ④.
- ▶ Remove wiper blade ① in the direction of arrow ⑤.

Installing the wiper blades

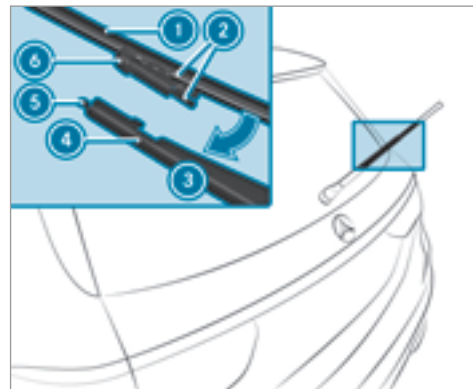

- ▶ Position new wiper blade ① with recess ⑥ on lug ⑤.
- ▶ Fold wiper blade ① in the direction of arrow ③ onto the wiper arm until retaining clips ② engage in bracket ④.
- ▶ Make sure that wiper blade ① sits correctly.
- ▶ Fold the wiper arm back onto the rear window.

Mirrors

Operating the outside mirrors

- ⚠ **WARNING** Risk of injury from adjusting the vehicle settings while the vehicle is in motion

You could lose control of the vehicle in the following situations:

- if you adjust the driver's seat, the head restraint, the steering wheel or the mirror while the vehicle is in motion
- if you fasten your seat belt while the vehicle is in motion

- ▶ Before starting the engine: adjust the driver's seat, the head restraint, the steering wheel or the mirror and fasten your seat belt.

- ⚠ **WARNING** Risk of accident due to misjudgment of distances when using the passenger mirror

The outside mirror on the front passenger side reflects objects on a smaller scale. The objects in view are in fact closer than they appear.

As a result, you may misjudge the distance between you and the road user driving behind you, for example, when changing lanes.

- ▶ Therefore, always look over your shoulder in order to ensure that you are aware of the actual distance between you and the road users driving behind you.

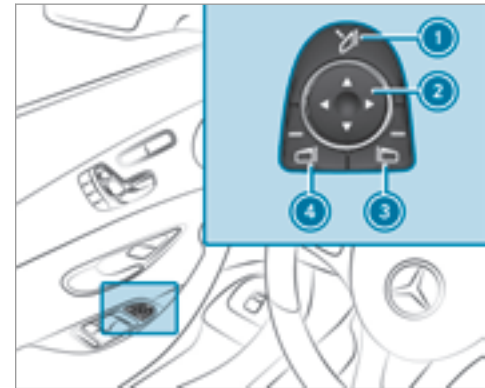

- ▶ **To fold in or out:** briefly press button ①.
- ⓘ If the battery has been disconnected or completely discharged, the outside mirrors must be reset. Only then will the automatic mirror folding function work properly.
- ▶ **To adjust:** select the required mirror using button ③ or ④.

- ▶ Use button ② to set the position of the mirror you have selected.

An outside mirror which has been pushed out of position can be engaged in position again in the following manner:

- ▶ **Vehicles with electrically folding outside mirrors:** press and hold button ①. You will hear a click and the mirror audibly engage in position. The mirror is set into the correct position.

Automatic anti-glare mirrors

⚠ WARNING Risk of burns and poisoning due to the anti-glare mirror electrolyte

Electrolyte may escape if the glass in an automatic anti-glare mirror breaks.

The electrolyte is harmful and causes irritation. It must not come into contact with your skin, eyes, respiratory organs or clothing or be swallowed.

- ▶ If you come into contact with electrolyte, observe the following:

- Rinse the electrolyte from your skin and seek medical attention immediately.
- If electrolyte comes into contact with your eyes, rinse them thoroughly with clean water and seek medical attention immediately.
- If the electrolyte is swallowed, immediately rinse your mouth out thoroughly. Do not induce vomiting. Seek medical attention immediately.
- Immediately change out of clothing which has come into contact with electrolyte.
- If an allergic reaction occurs, seek medical attention immediately.

The inside rearview mirror and outside mirror on the driver's side automatically go into anti-glare mode if light from a headlamp hits the inside rearview mirror.

System limitations

The mirrors do not go into anti-glare mode in the following situations:

- the engine is switched off
- reverse gear is engaged
- interior lighting is switched on

Parking position of the passenger outside mirror

The parking position makes parking easier.

The passenger outside mirror tilts down and shows the rear wheel on the front passenger side if:

- the parking position is stored
- the passenger mirror is selected
- reverse gear is engaged

The passenger outside mirror moves back to its original position in the following situations:

- if you shift the transmission to another transmission position
- when driving faster than 9 mph (15 km/h)
- if you press the button for the outside mirror on the driver's side

Saving the parking position of the passenger outside mirror

Prerequisite

Reverse gear must not be engaged when storing using the memory button.

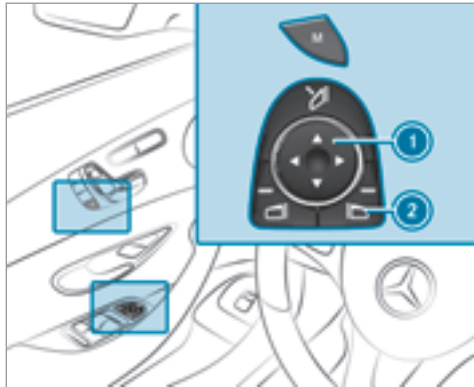

- ▶ **To store using the memory button:** select the passenger outside mirror using button ②.

- ▶ Move the passenger outside mirror into the desired parking position using button ①.
- ▶ Press memory button M.
- ▶ Confirm immediately using button ① to store the setting.
- ⓘ No more than three seconds may pass between pressing memory button M and button ①. The mirror setting process is canceled after three seconds.

Activating/deactivating the automatic mirror folding function

Multimedia system:

- ↳ **Vehicle** ▶ **Vehicle Settings** ▶ **Automatic Mirror Folding**
- ▶ Activate or deactivate the function.

Operating the sun visors

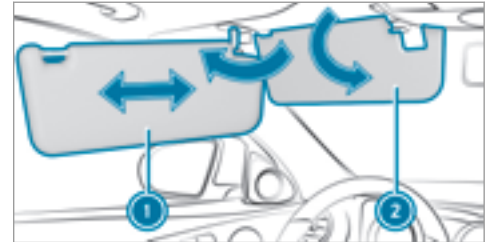

- ▶ **Glare from the front:** fold sun visor ① down.
- ▶ **Glare from the side:** swing sun visor ① to the side.
- ▶ Slide sun visor ① horizontally as required.
- ▶ Fold down additional sun visor ②.

Infrared reflective windshield

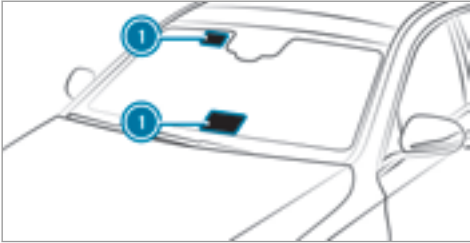

The infrared reflective windshield is coated and prevents an excessive build-up of heat in the vehicle interior.

The coating shields the vehicle interior against radio waves up into the gigahertz range.

Radio-controlled equipment, such as toll systems, can only be mounted on areas of the windshield which are permeable to radio waves ①.

Areas permeable to radio waves ① are best visible from outside the vehicle when the windshield is illuminated using an external light source.

Overview of climate control systems

Notes on climate control

In order for the air conditioning system, the monitoring of the level of pollution and the filtering of the air function correctly, an interior air filter must always be used. Make sure that the filter is installed correctly and the filter housing in the engine compartment is closed correctly using the cover and always tightly sealed when in operation. Use filters recommended and approved by Mercedes-Benz. Always have service work carried out at a qualified specialist workshop.

Dual-zone climate control overview

The indicator lamps in the buttons indicate that the current function is activated.

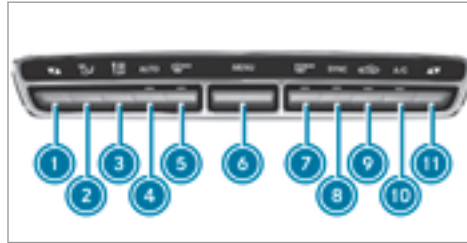

- ① Sets the driver's side temperature
- ② Sets the air distribution
- ③ Sets the airflow or switch off climate control
- ④ Sets climate control to automatic mode (→ page 128)
- ⑤ Defrosts the windshield
- ⑥ Calls up the climate control menu of the multimedia system
- ⑦ Switches the rear window heater on/off
- ⑧ Activates or deactivates synchronization (→ page 128)
- ⑨ Switches air-recirculation mode on/off (→ page 129)

- ⑩ Switches the A/C function on/off (→ page 128)
- ⑪ Sets the front passenger side temperature

Overview of the multimedia system climate control settings

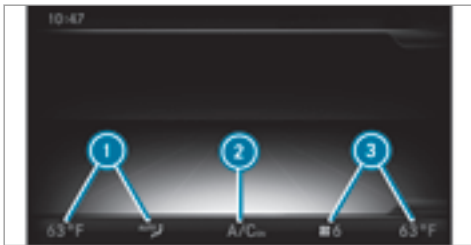

The climate control settings can be adjusted using the climate control bar or the climate control menu.



- ① To adjust the temperature and air distribution and display the current setting
- ② To call up the climate control menu and display the current cooling setting
- ③ To adjust the airflow and temperature and display the current setting

Operating the climate control system

Activating/deactivating climate control

- ▶ **To activate:** set the airflow to level 1 or higher using the  button.
- ▶ **To deactivate:** set the airflow to level 0 using the  button.

- ⓘ If climate control is deactivated, the windows can fog up more quickly. Deactivate climate control only briefly.

Activating/deactivating the A/C function via the control panel

The A/C function cools, heats and dehumidifies the interior air in the vehicle.



- ▶ Press the  button.

Deactivate the A/C function only briefly otherwise the windows can fog up more quickly.

Condensation may drip from the underside of the vehicle when cooling mode is active. This is not a sign that there is a malfunction.









Setting climate control to automatic mode

In automatic mode, the set temperature is controlled and maintained at a constant level by the air supply.

- ▶ Press the  button.
- ▶ **To switch to manual mode:** press the  or  button.

Air distribution settings

The symbols in the display indicate which vents the airflow is being directed through:

-  Defroster vent
-  Center and side air vents
-  Footwell vents
-  Center, side and footwell vents
-  Defroster and footwell vents
-  All vents
-  Defroster, middle and side air vents
-  Automatic air distribution

Activating/deactivating the climate control synchronization function via the control panel

Climate control can be set centrally using the synchronization function. The temperature and air distribution setting for the driver's side is adopted automatically for the front passenger side.

- ▶ Press the  button.

The synchronization function is deactivated if the settings for one of the other climate zones are changed.

Defrosting the windows

Windows fogged up on the inside

- ▶ Press the **AUTO** button.
- ▶ If the windows continue to fog up: press the  button.

Windows fogged up on the outside

- ▶ Switch on the windshield wipers.
- ▶ Press the **AUTO** button.

Switching air-recirculation mode on/off

- ▶ Press the  button.
The interior air will be recirculated.

Air-recirculation mode is switched off automatically.

- ⓘ If air-recirculation mode is switched on, the windows may fog up more quickly. Switch on air-recirculation mode only briefly.

Activating and deactivating ionization

Multimedia system:



Ionization cleans and refreshes the interior air of the vehicle. The ionization of the interior air is odorless.

- ▶ **To call up the climate control bar:** navigate down until the climate control bar is active.
- ▶ Call up the **A/C On/Off** climate control menu.
- ▶ Select **Ionization**.
- ▶ Activate or deactivate the function.
- ⓘ The climate control bar can be called up from any menu.

Perfume atomizer

Activating or deactivating the fragrance system

Prerequisites

- Automatic climate control is activated.
- The glove box is closed.

Multimedia system:



The fragrance system distributes a pleasant fragrance throughout the vehicle interior from a flacon located in the glove box.

- ▶ **To call up the climate control bar:** navigate down until the climate control bar is active.
- ▶ Call up the **A/C On/Off** climate control menu.
- ▶ Select **Air Freshener**.
- ▶ Activate or deactivate fragrancing.
- ▶ Adjust the intensity.
- ⓘ The climate control bar can be called up from any menu.

Inserting or removing the flacon of the fragrance system

⚠ WARNING Risk of injury from liquid perfume

If children open the flacon, they could drink the liquid perfume or it could come into contact with their eyes.

- ▶ Consult a doctor immediately if liquid perfume has been drunk.
- ▶ If liquid perfume comes into contact with your eyes or skin, rinse your eyes with clean water.
- ▶ If symptoms continue, consult a doctor.



ENVIRONMENTAL NOTE Environmental damage due to improper disposal of full flacons



Full flacons must not be disposed of with household waste.



Full flacons must be taken to a harmful substance collection point.

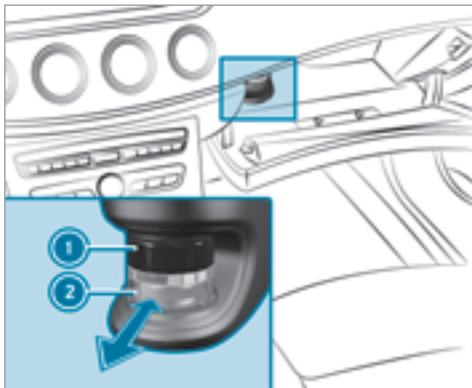

- ① Cap
- ② Flacon

- ▶ **To insert:** slide the flacon into the holder as far as it will go.
- ▶ **To remove:** pull out the flacon.

If you do not use genuine Mercedes-Benz interior perfumes, observe the manufacturers' safety notices on the perfume packaging.

Dispose of the genuine Mercedes-Benz interior perfume flacon when it is empty and do not refill it.

Refillable flacon

- ▶ Unscrew the cap of the empty flacon.
- ▶ Fill the flacon with a maximum of 0.5 fl. oz. (15 ml).
- ▶ Screw the cap back on to the flacon.

Always refill the empty refillable flacon with the same perfume. Observe the separate information sheet attached to the flacon.

Information on the windshield heater

The windshield heater is switched on automatically:

- If the  button is activated.

After the vehicle is started the windshield heater is switched on automatically as needed.

Air vents

Adjusting the front air vents

⚠ WARNING - Danger of burns or frostbite due to being too close to the air vents

Very hot or very cold air can flow from the air vents.

This could result in burns or frostbite in the immediate vicinity of the air vents.

- ▶ Make sure that all vehicle occupants always maintain a sufficient distance to the air vents.
- ▶ If necessary, direct the airflow to another area of the vehicle interior.



- ▶ **To open or close:** turn controller ② to the left or right as far as it will go.
- ▶ **To adjust the airflow direction:** hold air vent ① in the center and move it up or down or to the left or right.

Adjusting the rear air vents

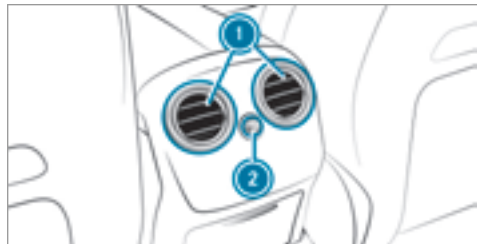

- ▶ **To open or close:** turn controller ② to the left or right as far as it will go.
- ▶ **To adjust the air direction:** hold rear air vent ① in the center and move it up or down or to the left or right.

Opening/closing the air vent in the glove box

! **NOTE** Damage to temperature-sensitive objects in the glove box

Temperature-sensitive objects stored in the glove box may be damaged by the air vent located inside it.

- ▶ Close the air vent when you heat the vehicle.
- ▶ At high outside temperatures, open the air vent and switch on the A/C function.

Requirement:

Automatic climate control is activated.

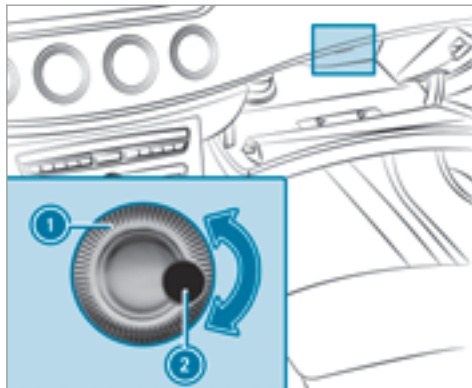

① Air vent controller

② Air vent

- ▶ **To open or close:** turn controller ① to the left or right.

Driving

Switching on the power supply or ignition using the start/stop button

⚠ WARNING Risk of accident and injury due to children left unattended in the vehicle

If children are left unattended in the vehicle, they could:

- Open doors, thereby endangering other persons or road users
- Get out of the vehicle and be hit by oncoming traffic
- Operate vehicle equipment

In addition, the children could also set the vehicle in motion, for example, by:

- Releasing the parking brake
- Shifting the transmission out of park position **P**
- Starting the engine.

- ▶ Never leave children and animals unattended in the vehicle.
- ▶ When leaving the vehicle, always take the SmartKey with you and lock the vehicle.
- ▶ Keep the SmartKey out of the reach of children.

⚠ WARNING Risk of exhaust gas poisoning

Combustion engines emit poisonous exhaust gases such as carbon monoxide. Inhaling these exhaust gases causes poisoning.

- ▶ Never leave the engine running in an enclosed space without sufficient ventilation.

⚠ WARNING Risk of fire caused by flammable material on the exhaust system

Flammable materials brought in by either animals or environmental influences may ignite if they come into contact with hot parts of the engine or exhaust system.

- ▶ Therefore, check regularly that there are no flammable materials in the engine compartment or on the exhaust system.

Requirements

- The SmartKey is located in the vehicle and the SmartKey battery is not discharged.

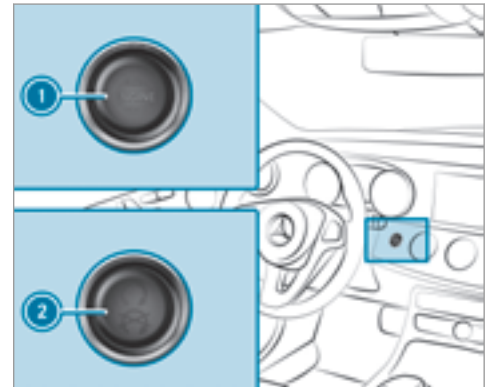

- ▶ **To switch on the power supply:** press button ① (USA) or ② (Canada) once. You can now activate the windshield wiper, for example.

The power supply is switched off again if the following conditions are met:

- The driver's door is open.
- You press button ① (USA) or ② (Canada) twice.

- ▶ **To switch on the ignition:** press button ① (USA) or ② (Canada) twice. The indicator lamps in the instrument cluster light up.

The ignition is switched off again if one of the following conditions is met:

- You do not start the vehicle within 15 minutes.
- You press button ① (USA) or ② (Canada) once.

Starting the vehicle

Starting the vehicle with the start/stop button

Requirements

- The SmartKey is located in the vehicle and the SmartKey battery is not discharged.
- ▶ Shift the transmission to position **P** or **N**.
- ▶ Depress the brake pedal and push button ① (USA) or ② (Canada) once.
- ▶ If the vehicle does not start: switch off non-essential consumers and press button ① (USA) or ② (Canada) once.
- ▶ If the vehicle still does not start: start the vehicle in emergency operation mode.

Cooling or heating the vehicle interior before starting the journey

If you start the vehicle via your smartphone, the previously selected climate control setting is active.

Before starting, make sure:

- The legal stipulations in the area where your vehicle is parked permit engine starting via smartphone.
- It is safe to start and run the engine where your vehicle is parked.
- The fuel tank is sufficiently filled.
- The starter battery has sufficient charge.
- ① You can also set the temperature with your smartphone. Information on Mercedes me connect and other services: <http://www.mercedes.me>.

Starting the vehicle using a smartphone

⚠ WARNING Risk of crushing or entrapment due to unintentional starting of the engine

Limbs could be crushed or trapped if the engine is started unintentionally during service or maintenance work.

- ▶ Always secure the engine against unintentional starting before carrying out maintenance or repair work.

Requirements

- Park position **P** is selected.
- The anti-theft alarm system is not armed.
- The panic alarm is not armed.
- The hazard warning lights are switched off.
- The engine hood is closed.
- The doors are closed and locked.
- The windows and sliding sunroof are closed.
- ▶ Start the vehicle using the smartphone:
 - After every vehicle start, the engine runs for ten minutes.
 - You can carry out a maximum of two consecutive starting attempts.
 - You can stop the vehicle again at any time.
 - Further information can be found in the smartphone app.

Securing the engine against starting before carrying out maintenance or repair work:

- ▶ Switch on the hazard warning lights.
- or
- ▶ Unlock the doors.
- or
- ▶ Open a side window or the sliding sunroof.

Starting the vehicle in emergency operation mode

If the vehicle cannot be started, the [Place the Key in the Marked Space](#) See Operator's Manual display message appears in the multifunction display.



- ▶ Make sure that marked space ② is empty.
- ▶ Remove SmartKey ① from the key ring.
- ▶ Place SmartKey ① in marked space ②. The vehicle will start after a short while.
- If you remove SmartKey ① from marked space ② the engine continues running. For further vehicle starts however, SmartKey ① must be located in marked space ② during the entire journey.
- ▶ Have SmartKey ① checked at a qualified specialist workshop.

If the vehicle does not start:

- ▶ Leave SmartKey ① in marked space ②.
- ▶ Depress the brake pedal and start the vehicle using the start/stop button.
- ① You can also switch on the power supply or the ignition with the start/stop button.

Notes on breaking-in a new vehicle

To preserve the engine during the first 1,000 miles (1,500 km):

- Drive at varying road speeds and engine speeds.
- Drive in drive program **C** or **E**.
- Change up before the tachometer needle is $\frac{2}{3}$ of the way to the red area of the tachometer.
- Do not shift down a gear manually in order to brake.
- Avoid overstraining the vehicle, e.g. driving at full throttle.
- Do not depress the accelerator pedal beyond the pressure point (kickdown).
- Only increase the engine speed gradually and accelerate the vehicle to full speed after 1,000 miles (1,500 km).

This also applies when the engine or parts of the drivetrain have been replaced.

Please also observe the following running-in notes:

- In certain driving and driving safety systems, the sensors adjust automatically while a certain distance is being driven after the vehicle has been delivered or after repairs. Full system effectiveness is not achieved until the end of this teach-in process.
- Brake linings, brake discs and tires that are either new or have been replaced only achieve optimum braking effect and grip after several hundred kilometers of driving. Compensate for the reduced braking effect by applying greater force to the brake pedal.

Driving tips

⚠ WARNING Risk of accident due to objects in the driver's footwell

Objects in the driver's footwell may impede pedal travel or block a depressed pedal.

This jeopardizes the operating and road safety of the vehicle.

- ▶ Stow all objects in the vehicle securely so that they cannot get into the driver's footwell.
- ▶ Ensure floor mats and carpets cannot slip and provide sufficient room for the pedals.
- ▶ Do not lay multiple floor mats or carpets on top of one another.

⚠ WARNING Risk of accident due to unsuitable footwear

Operation of the pedals may be restricted due to unsuitable footwear such as:

- Shoes with platform soles
- Shoes with high heels
- Slippers
- ▶ When driving always wear suitable shoes in order to be able to operate the pedals safely.

⚠ WARNING Risk of accident due to the ignition being switched off whilst the vehicle is in motion

If you switch off the ignition whilst the vehicle is in motion safety-relevant functions will be restricted or no longer available. This may affect the power steering system and brake force boosting, for example.

You will need to use considerably more force to steer and brake.

- ▶ Do not switch off the ignition whilst the vehicle is in motion.

⚠ WARNING Risk of exhaust gas poisoning

Combustion engines emit poisonous exhaust gases such as carbon monoxide. Inhaling these exhaust gases causes poisoning.

- ▶ Never leave the engine running in an enclosed space without sufficient ventilation.

⚠ WARNING Risk of skidding and of an accident due to shifting down on slippery road surfaces

If you shift down on slippery road surfaces to increase the engine braking effect, the drive wheels may lose traction.

- ▶ Do not shift down on slippery road surfaces to increase the engine braking effect.

⚠ DANGER Risk of fatal injury due to poisonous exhaust gases

If the tailpipe is blocked or sufficient ventilation is not possible, poisonous exhaust gases such as carbon monoxide may enter the vehicle. This is the case if the vehicle gets stuck in snow, for example.

- ▶ Keep the tailpipe and the area around the vehicle free from snow when the engine or the stationary heater are running.

- ▶ Open a window on the windward side of the vehicle to ensure an adequate supply of fresh air.

⚠ WARNING Risk of accident or injury due to driving under the influence of alcohol and drugs

Driving and the consumption of alcohol and/or drugs are an extremely dangerous combination. Even small quantities of alcohol or drugs can compromise your reflexes, perception and judgment.

The possibility of a serious or even fatal accident is greatly increased when you drink or take drugs and drive.

- ▶ Do not drink or take drugs and drive or allow anyone to drive who has been drinking alcohol or taking drugs.

⚠ WARNING Risk of accident due to the brake system overheating

If you leave your foot on the brake pedal when driving, the brake system may overheat.

This increases the braking distance and the brake system may even fail.

- ▶ Never use the brake pedal as a footrest.
- ▶ Do not depress the brake pedal and the accelerator pedal at the same time while driving.

! NOTE Wearing out the brake linings by continuously depressing the brake pedal

- ▶ Do not depress the brake pedal continuously whilst driving.
- ▶ To use the braking effect of the engine, shift to a lower gear in good time.

! NOTE Damage to the drivetrain and the engine when pulling away

- ▶ Do not warm up the engine when the vehicle is stationary. Pull away immediately.
- ▶ Avoid high engine speeds and driving at full throttle until the engine has reached operating temperature.
- ▶ Do not allow the wheels to spin.

! NOTE Damage to the catalytic converter due to non-combusted fuel

The engine is not running smoothly and is misfiring.

Non-combusted fuel may get into the catalytic converter.

- ▶ Only depress the accelerator pedal slightly.
- ▶ Have the cause rectified immediately at a qualified specialist workshop.

Limited braking effect on salt-treated roads:

- Due to salt build-up on the brake discs and brake lining, the braking distance can increase considerably or result in braking only on one side.
- Maintain a much greater distance to the vehicle in front.

To prevent salt build-up:

- Brake occasionally while paying attention to the traffic conditions.
- Carefully depress the brake pedal at the end of the journey and when starting the next journey.

ECO start/stop function

Operation of the ECO start/stop function

The engine is switched off automatically:

- If you brake the vehicle to a standstill in transmission position **D** or **N**.
- If all vehicle conditions for an automatic engine stop are met.

The **(A)** symbol appears in the multifunction display when the vehicle is stationary.

The engine is restarted automatically if:

- You release the brake pedal with the transmission in position **(D)** when the HOLD function is not active.
- You shift from transmission position **(P)**.
- You engage transmission position **(D)** or **(R)**.
- You depress the accelerator pedal.
- You switch to drive program **S+**.
- You change the vehicle level.
- An automatic engine start is necessary.

If the engine was switched off by the ECO start/stop function and you leave the vehicle, a warning tone sounds. The [Vehicle Operational Switch the Ignition Off Before Exiting](#) display message also appears in the multifunction display.

If you do not switch off the ignition, the ignition is automatically switched off after one minute.

Deactivating or activating the ECO start/stop function

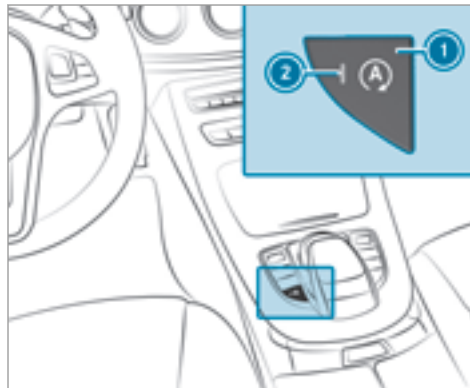

- ▶ Press button **(1)**.
If indicator lamp **(2)** lights up, the ECO start/stop function is switched on.

- (i)** Depending on the model, the button may also be located at a different position in the center console.

ECO display

The ECO display summarizes the driving style from the start of the journey to its completion and assists you in achieving the most economical driving style.

You can influence consumption if you:

- drive with particular care
- drive the vehicle in drive program **E**
- observe the gearshift recommendations



The inner segment lights up green and the outer segment fills up:

- **(1)** Moderate acceleration

- ② Gentle deceleration and rolling
- ③ Consistent speed

The inner segment is gray and the outer segment empties:

- ① Sporty acceleration
- ② Heavy braking
- ③ Fluctuations in speed

You have driven economically when:

- the three outer segments are completely filled simultaneously.
- the ECO display border lights up.

The additional range achieved as a result of your driving style in comparison to a driver with a very sporty driving style is shown under **Bonus fr. Start**. The range displayed does not indicate a fixed reduction in consumption.

DYNAMIC SELECT switch

Function of the DYNAMIC SELECT switch

Use the DYNAMIC SELECT switch to change between the following drive programs:

- **I (Individual)**: individual settings
- **S+ (Sport Plus)**: particularly sporty driving style
- **S (Sport)**: sporty driving style
- **C (Comfort)**: comfortable and economical driving style
- **E (Economy)**: particularly economical driving style

Depending on the drive program selected, the following vehicle characteristics will change:

- Drive system
 - Engine and transmission management
 - ESP®
 - Distance Pilot DISTRONIC
- Suspension
- Steering

- Availability of the ECO start/stop function

Operating the DYNAMIC SELECT switch

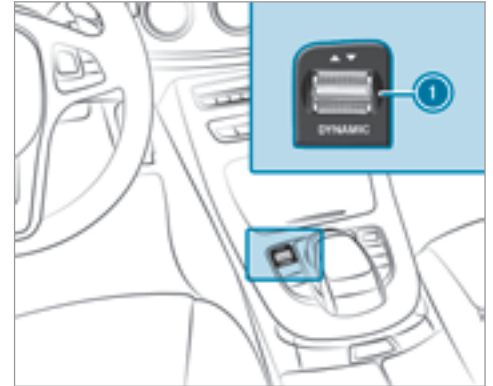

- ▶ Press DYNAMIC SELECT switch ① forwards or backwards. The drive program selected appears in the multifunction display.

Configuring drive program I

Multimedia system:

↳ Vehicle ▶ DYNAMIC SELECT ▶ Individual

▶ Select the individual setting.

Automatic transmission

DIRECT SELECT selector lever

Function of the DIRECT SELECT lever

⚠ WARNING Risk of accident and injury due to children left unattended in the vehicle

If children are left unattended in the vehicle, they could:

- Open doors, thereby endangering other persons or road users
- Get out of the vehicle and be hit by oncoming traffic
- Operate vehicle equipment

In addition, the children could also set the vehicle in motion, for example, by:

- Releasing the parking brake
 - Shifting the transmission out of park position **P**
 - Starting the engine.
- ▶ Never leave children and animals unattended in the vehicle.
 - ▶ When leaving the vehicle, always take the SmartKey with you and lock the vehicle.
 - ▶ Keep the SmartKey out of the reach of children.

⚠ WARNING Risk of accident due to incorrect gearshifting

If the engine speed is higher than the idle speed and you engage the transmission position **D** or **R**, the vehicle may accelerate sharply.

- ▶ If you engage the transmission position **D** or **R** always depress the brake

pedal firmly and do not accelerate at the same time.

! **NOTE** Damage to the automatic transmission caused by changing the transmission position during the journey

- ▶ Only change the transmission position when the vehicle is stationary.

Use the DIRECT SELECT lever to shift the transmission position. The current transmission position is displayed in the multifunction display.

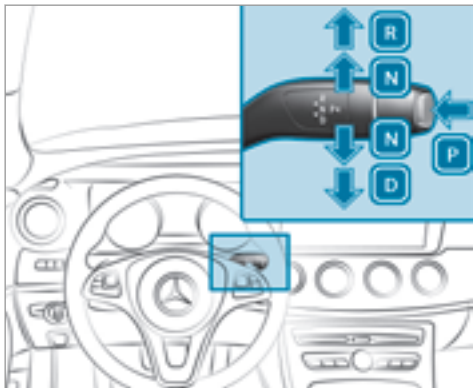

- P** Park position
- R** Reverse gear
- N** Neutral
- D** Drive position

Engaging reverse gear R

- ▶ Depress the brake pedal and push the DIRECT SELECT lever up past the first point of resistance. The transmission position display shows **R** in the multifunction display.

Shifting to neutral N

- ▶ Depress the brake pedal and push the DIRECT SELECT lever up or down to the first point of resistance. Transmission position display **N** is shown in the multifunction display.

Releasing the brake pedal will allow you to move the vehicle freely, e.g. to push it or tow it away.

If you want the automatic transmission to remain in neutral N even if the ignition is switched off:

- ▶ Start the vehicle.
- ▶ Depress the brake pedal and shift to neutral **N**.
- ▶ Release the brake pedal.
- ▶ Switch the ignition off.

- ⓘ If you leave the SmartKey in the vehicle and then exit the vehicle, the automatic transmission remains in neutral **N**

Engaging park position P

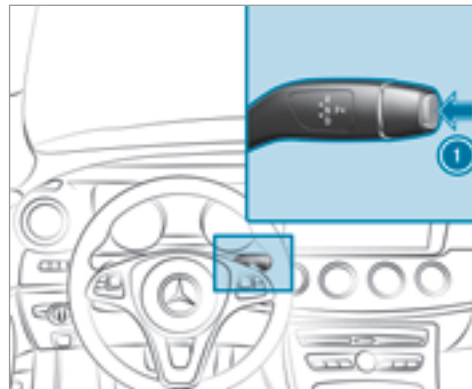

- ▶ Press button **1**. Transmission position display **P** is shown in the multifunction display.

Park position **P** is engaged automatically if one of the following conditions is met:

- You switch the engine off with the transmission in position **D** or **R**.
- You open the driver's door when the vehicle is stationary or when driving at a very low speed and the transmission is in position **D** or **R**.

Engaging drive position D

- ▶ Depress the brake pedal and push the DIRECT SELECT lever down past the first point of resistance. The transmission position display shows **D** in the multifunction display.

When the automatic transmission is in transmission position **D**, it shifts the gears automatically. This is determined by:

- The selected drive program
- The position of the accelerator pedal
- The road speed

Manual gear shifting

⚠ WARNING Risk of skidding and of an accident due to shifting down on slippery road surfaces

If you shift down on slippery road surfaces to increase the engine braking effect, the drive wheels may lose traction.

- ▶ Do not shift down on slippery road surfaces to increase the engine braking effect.



- ▶ **To activate:** pull steering wheel gearshift paddle ① or ②. Manual gearshifting is activated for a short time. The current gear is displayed in the multifunction display.
 - ▶ **To shift up:** pull steering wheel gearshift paddle ②.
 - ▶ **To shift down:** pull steering wheel gearshift paddle ①.
 - ▶ **To deactivate:** pull steering wheel gearshift paddle ② and hold it in place. The transmission position **D** appears in the multifunction display.
- ⓘ If you select the **Manual** drive setting in drive program **I**, manual gearshifting is permanently activated.

Gearshift recommendation

The gearshift recommendations assist you in adopting an economical driving style.



- ▶ If gearshift recommendation message ❶ is shown in the multifunction display, shift to the recommended gear.

Using kickdown

- ▶ **Maximum acceleration:** depress the accelerator pedal beyond the pressure point.

During kickdown, you cannot shift gears using the steering wheel gearshift paddles. The automatic transmission shifts up to the next gear when the maximum engine speed is reached to protect the engine from overrevving.

- ▶ Ease off the accelerator pedal once the desired speed is reached.

Glide mode function

Glide mode helps you to reduce fuel consumption.

Glide mode is characterized by the following:

- The combustion engine is disconnected from the drivetrain.
- The engine speed corresponds to the idle speed.

Glide mode is activated if the following conditions are met:

- Drive program **E** is selected.
- The speed is within a suitable range.
- The course of the road is suitable, for example, no steep uphill or downhill gradients.
- You are no longer depressing the accelerator or brake pedal.

- ❶ Glide mode can also be activated if you have selected the "Eco" setting for the drive

(engine management) when in drive program **I**.

Glide mode is deactivated again if one of the conditions is no longer met.

Vehicles with Driving Assistance Package, Distance Pilot DISTRONIC or Active Brake Assist:

Glide mode is also deactivated depending on the traffic situation and the vehicle then switches to overrun mode. This further reduces fuel consumption.

Glide mode can also be prevented by the following parameters:

- Gradient
- Temperature
- Height
- Speed
- Obstacle detection
- Operating condition of the engine

Refueling

Refueling the vehicle

⚠ WARNING Risk of fire and explosion caused by fuel

Fuels are highly inflammable.

- ▶ You must avoid fire, open flames, creating sparks and smoking.
- ▶ Before refueling, switch off the engine and, if installed in your vehicle, the stationary heater.

⚠ WARNING Risk of injury from fuel

Fuels are poisonous and harmful to your health

- ▶ Do not swallow fuel or let it come into contact with skin, eyes or clothing.
- ▶ Do not inhale fuel vapors.
- ▶ Keep children away from fuel.

If you or other people come into contact with fuel, observe the following:

- ▶ Immediately rinse fuel off your skin with soap and water.
- ▶ If fuel comes into contact with your eyes, immediately rinse them thoroughly with clean water. Seek medical attention immediately.
- ▶ If you swallow fuel, seek medical attention immediately. Do not induce vomiting.
- ▶ Change immediately out of clothing that has come into contact with fuel.

⚠ WARNING Risk of explosion or fire due to electrostatic charge

Electrostatic charge can cause sparks and thereby ignite fuel vapors.

- ▶ Always touch the metal vehicle body before opening the fuel filler cap or touching the pump nozzle.

This discharges any electrostatic charge that may have built up.

! NOTE Damage caused by the wrong fuel

Fuel that does not conform to the required quality can lead to increased wear as well as damage to the engine and exhaust system.

- ▶ Only use the fuel recommended.

! NOTE Damage caused by the wrong fuel

Vehicles with a gasoline engine:

Even small amounts of the wrong fuel could result in damage to the fuel system, the engine and the emission control system.

- ▶ Only refuel with low-sulfur premium grade fuel.

This fuel may contain up to 10 % ethanol. Your vehicle is suitable for use with E10 fuel.

Do not refuel using:

- Diesel
- E15, E85, E100

- Gasoline containing methanol (M15, M30, M85, M100)

- Gasoline with additives containing metal

If you accidentally refuel with the wrong fuel:

- ▶ Do not switch the ignition on.
- ▶ Consult a qualified specialist workshop.

! **NOTE** Do not use diesel to refuel vehicles with a gasoline engine.

- ▶ Do not switch on the ignition if you accidentally refuel with the wrong fuel. Otherwise, fuel can enter the fuel system. Even small amounts of the wrong fuel could result in damage to the fuel system and the engine. Notify a qualified specialist workshop and have the fuel tank and fuel lines drained completely.

! **NOTE** Do not overfill the fuel tank as this may damage the fuel system.

- ▶ Only fill the fuel tank until the pump nozzle switches off.

! **NOTE** Do not overfill the fuel tank as otherwise fuel could spray out when the pump nozzle is removed.

- ▶ Only fill the fuel tank until the pump nozzle switches off.

Prerequisite

The vehicle must be unlocked.

- i** Do not get into the vehicle again during the refueling process. Otherwise, electrostatic charge could build up again.

Observe the notes on operating fluids (→ page 318).

Refueling

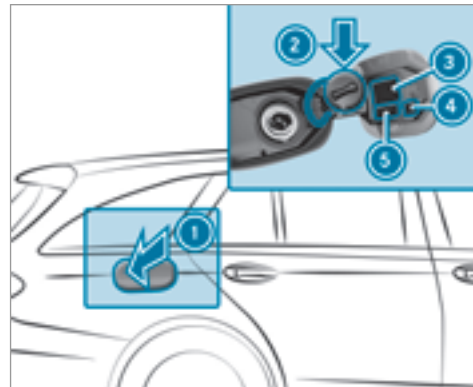

- ① Fuel filler flap
- ② Bracket for the fuel filler cap
- ③ Tire pressure table
- ④ QR code for rescue card
- ⑤ Fuel type

- ▶ Press fuel filler flap ①.

- ▶ Turn the fuel filler cap counter-clockwise and remove it.
- ▶ Insert the fuel filler cap into holder ②.
- ▶ Completely insert the filler neck of the fuel pump nozzle into the tank, hook in place and refuel.
- ▶ Only fill the fuel tank until the pump nozzle switches off.

Parking

Switching off the vehicle with the start/stop button

⚠ WARNING Risk of fire caused by hot exhaust system parts

Flammable material such as leaves, grass or twigs may ignite if they come into contact with hot parts of the exhaust system or exhaust gas flow.

- ▶ Park the vehicle so that no flammable material can come into contact with hot vehicle components.

- ▶ In particular, do not park on dry grass-land or harvested grain fields.

⚠ WARNING Risk of accident and injury due to children left unattended in the vehicle

If you leave children unaccompanied in the vehicle, they may be able to set the vehicle in motion, for example by:

- Releasing the parking brake.
- Shifting the transmission out of park position **P**.
- Starting the engine.

In addition, they may operate vehicle equipment.

- ▶ Never leave children and animals unattended in the vehicle.
- ▶ When leaving the vehicle, always take the SmartKey with you and lock the vehicle.

⚠ NOTE Damage to the vehicle or the drivetrain caused by the vehicle rolling away

- ▶ Always properly secure the vehicle against rolling away.

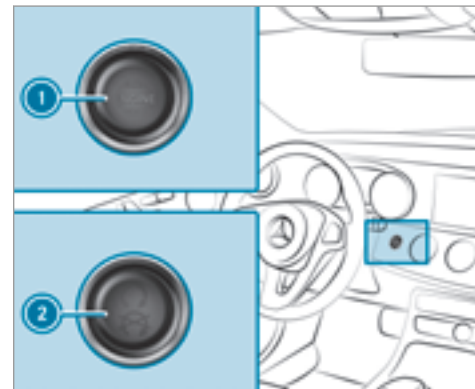

- ▶ On uphill or downhill inclines, turn the front wheels towards the curb.
- ▶ Apply the electric parking brake.

▶ Press button ① (USA) or ② (Canada) once.

① When you switch off the vehicle, you can still operate the side windows and the panoramic sliding sunroof for five minutes.

Garage door opener

Programming buttons for the garage door opener

⚠ WARNING Risk of exhaust gas poisoning

Combustion engines emit poisonous exhaust gases such as carbon monoxide. Inhaling these exhaust gases causes poisoning.

▶ Never leave the engine running in an enclosed space without sufficient ventilation.

⚠ WARNING Risk of injury and entrapment when opening the garage door using the garage door opener

When you operate or program the garage door with the integrated garage door opener,

persons in the range of movement of the garage door can become trapped or struck by the garage door.

▶ When using the integrated garage door opener, always make sure that nobody is within the sweep of the garage door.

Only operate the garage door opener on the following garage doors:

- Garage doors with a safety stop and reversing feature.
- Garage doors which conform to the current U.S. safety standards.

Prior to programming a garage door opener, park the vehicle outside the garage and switch off the engine.

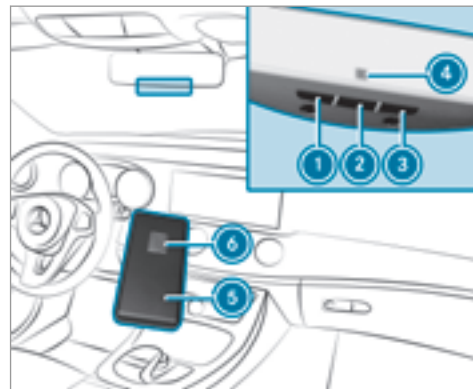

▶ Check if the transmitter frequency of the remote control has the frequency range of 280 to 868 MHz.

Radio equipment approval number:

- NZLMUAHL5 (USA)
- 4112A-MUAHL5 (Canada)

▶ Press and hold button ①, ② or ③ that you wish to program.
Indicator lamp ④ flashes yellow.

ⓘ It can take up to 20 seconds before the indicator lamp flashes yellow.

▶ Release the previously pressed button.
Indicator lamp ④ continues to flash yellow.

▶ Point remote control ⑤ at a distance of 1 in (1 cm) to 3 in (8 cm) towards buttons ①, ② or ③.

▶ Press and hold button ⑥ of remote control ⑤ until:

- Indicator lamp ④ lights up green continuously. Programming is complete.

- Indicator lamp ④ flashes green. Programming was successful. The rolling code must also be synchronized with the garage door system.

▶ If indicator lamp ④ does not light up or flash green: repeat the procedure.

▶ Release all of the buttons.

ⓘ The remote control for the garage door drive is not included in the scope of delivery of the garage door opener.

Synchronizing the rolling code

Requirements

- The garage door system uses a rolling code.
- The vehicle must be within range of the garage door or exterior gate drive.
- The vehicle as well as persons and objects, are located outside the sweep of the garage door.

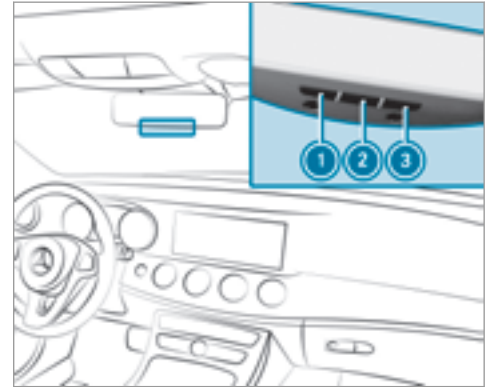

▶ Press the programming button on the door drive unit.
Initiate the next step within approximately 30 seconds.

▶ Press previously programmed button ①, ② or ③ repeatedly, until the door closes.
When the door closes, programming is completed.

- i** Please also read the operating instructions for the garage door drive.

Troubleshooting when programming the remote control

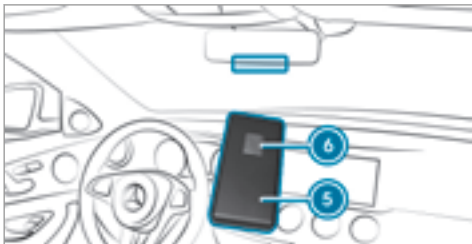

- ▶ Check if the transmitter frequency of remote control **5** is supported.
- ▶ Replace the batteries in remote control **5**.
- ▶ Hold remote control **5** at various angles at a distance between 1 in (1 cm) to 3 in (8 cm) in front of the inside rearview mirror. You should test every position for at least 25 seconds before trying another position.

- ▶ Hold remote control **5** at the same angles at various distances in front of the inside rearview mirror. You should test every position for at least 25 seconds before trying another position.
- ▶ Note that some remote controls transmit only for a limited period, press button **6** on remote control **5** again before transmission ends.
- ▶ Align the antenna line of the garage door opener unit with the remote control.

- i** Support and additional information on programming:
- On the toll free HomeLink® Hotline on 1-800-355-3515.
 - On the Internet at <http://www.homelink.com/mercedes>.

Opening/closing the garage door

Prerequisite

The corresponding button is programmed to operate the garage door.

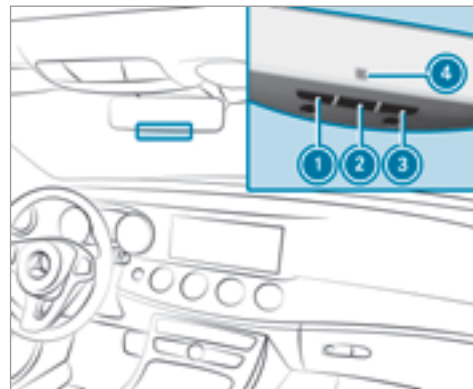

- ▶ Press and hold buttons **1**, **2** or **3** until the garage door opens or closes.
- ▶ If indicator lamp **4** flashes yellow after approximately 20 seconds: press and hold the previously pressed button again until the garage door opens or closes.

Clearing the garage door opener memory

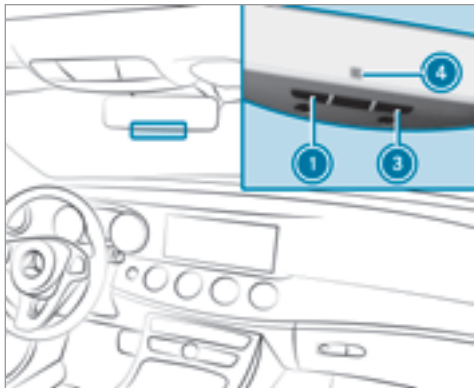

- ▶ Press and hold buttons ① and ③. Indicator lamp ④ lights up yellow.
- ▶ If indicator lamp ④ flashes green: release buttons ① and ③.

Radio equipment approval numbers for the garage door opener

- **Egypt:** TAC.2511151293.WIR

- **Andorra:** CE
- **Australia:** R-NZ
- **Barbados:** MED1578
- **Chile:** 2488/DFRS20576/F-74
- **European Union:** CE
- **Gibraltar:** CE
- **Iceland:** CE
- **Jordan:** TRC/LPD/2015/299
- **Canada:** 4112A-MUAHL5
- **Kuwait:** CE
- **Liechtenstein:** CE
- **Mexico:** RCPGEMU15-0448
- **Monaco:** CE
- **New Zealand:** R-NZ
- **Norway:** CE
- **Russian Federation:** not required
- **Saudi Arabia:** TA 10525
- **Switzerland:** CE
- **South Africa:** TA-2015/1386

- **Turkey:** not required
- **United Arab Emirates:** ER41849/15
- **United States:** NZLMUAHL5

Electric parking brake

Automatically applying the electric parking brake

⚠ WARNING Risk of accident and injury due to children left unattended in the vehicle

If you leave children unaccompanied in the vehicle, they may be able to set the vehicle in motion, for example by:

- Releasing the parking brake.
- Shifting the transmission out of park position **[P]**.
- Starting the engine.

In addition, they may operate vehicle equipment.

- ▶ Never leave children and animals unattended in the vehicle.
- ▶ When leaving the vehicle, always take the SmartKey with you and lock the vehicle.

The electric parking brake is applied if the transmission is in position **P** and one of the following conditions is fulfilled:

- The engine is switched off.
- The seat belt tongue is not inserted in the seat belt buckle of the driver's seat and the driver's door is opened.

i To prevent application: pull the handle of the electric parking brake.

In the following situations, the electric parking brake is also engaged:

- The Distance Pilot DISTRONIC brings the vehicle to a standstill.
- The HOLD function is keeping the vehicle stationary.
- Parking Pilot is keeping the vehicle stationary.

This is only the case if one of the following conditions is also fulfilled:

- The engine is switched off.
- The seat belt tongue is not inserted in the seat belt buckle of the driver's seat and the driver's door is opened.
- There is a system malfunction.
- The power supply is insufficient.
- The vehicle is stationary for a lengthy period.

When the electric parking brake is applied, the **PARK** (USA) or **(P)** (Canada) indicator lamp lights up in the instrument cluster.

The electric parking brake is not automatically applied if the engine is switched off by the ECO start/stop function.

Releasing the electric parking brake automatically

The electric parking brake is released when the following conditions are fulfilled:

- The engine is running.
- The seat belt tongue is inserted into the seat belt buckle of the driver's seat.

- The transmission is in position **D** or **R** and you depress the accelerator pedal or you shift from transmission position **P** to **D** or **R**.
- If the transmission is in position **R**, the trunk lid must be closed.

If the seat belt tongue is not inserted into the seat belt buckle of the driver's seat, the following conditions must be fulfilled:

- The driver's door is closed.
- You move the transmission out of transmission position **P** or you have previously driven faster than 2 mph (3 km/h).
- If the transmission is in position **R**, the trunk lid must be closed.

If the electric parking brake is released, the **PARK** (USA) or **(P)** (CANADA) indicator lamp in the instrument cluster goes out.

Applying or releasing the electric parking brake manually

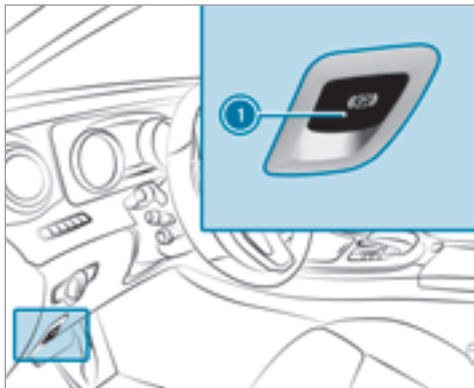

- ▶ **To apply:** push handle ①.
The **PARK** (USA) or **(P)** (Canada) indicator lamp appears in the instrument cluster.
- ▶ **To release:** switch on the ignition.

- ▶ Pull handle ①.
The **PARK** (USA) or **(P)** (Canada) indicator lamp in the instrument cluster goes out.

Emergency braking

- ▶ Press and hold handle ①.
When the vehicle has been braked to a standstill:
 - The electric parking brake is applied.
 - The **PARK** (USA) or **(P)** (Canada) indicator lamp appears in the instrument cluster.

Parking the vehicle for a long period

- If you leave the vehicle parked for longer than four weeks, damage may occur to the battery.
- If you leave the vehicle parked for longer than six weeks, it may suffer damage as a result of lack of use.
- Information on parking your vehicle for an extended period can be obtained at a qualified specialist workshop.

Standby mode

Standby mode function

Standby mode is characterized by the following:

- The vehicle can be parked over a long period of time without losing power.
- The vehicle battery is preserved.
- The maximum period out of use is displayed in the multimedia system display.
- Functions such as interior protection or tow-away protection are not available.
- The connection to online services is interrupted.

If the following conditions are fulfilled, standby mode can be activated or deactivated using the multimedia system:

- The engine is switched off.
- The ignition is switched on.

Exceeding the vehicle's displayed period out of use may cause inconvenience, i.e. it cannot be guaranteed that the starter battery will reliably start the engine.

The starter battery must be charged in the following situations:

- The vehicle's period out of use must be extended.
- A message appears in the multimedia system display explaining that the battery charge is insufficient for standby mode.

① Standby mode is automatically deactivated when the ignition is switched on.

Activating or deactivating standby mode

Multimedia system:

↪ Vehicle ➤ Vehicle Settings ➤ Standby Mode

- ▶ Activate or deactivate the function. When you activate the function, a prompt appears.
- ▶ Select **Yes**. Standby mode is activated.

Driving and driving safety systems

Driving systems and your responsibility

Your vehicle is equipped with driving systems which assist you in driving, parking and maneuvering the vehicle. The driving systems are aids and do not relieve you of your responsibility. Pay attention to the traffic conditions at all times and intervene when necessary. Be aware of the limitations regarding the safe use of these systems.

Function of the radar sensors

Some driving and driving safety systems use radar sensors to monitor the area in front of, behind or next to the vehicle (depending on the vehicle's equipment).

Depending on the vehicle's equipment, the radar sensors are integrated behind the bumpers and/or behind the radiator grille. Keep these parts free of dirt, ice and slush. The sensors must not be covered, for example by bicycle racks, overhanging loads or radar-reflecting stickers. Following an impact and in the event of

associated damage, which may not be visible, to the bumpers or radiator grille, have the function of the radar sensors checked at a qualified specialist workshop. The driver assistance system may no longer work properly.

Overview of driving and driving safety systems

In this section, you will find information about the following driving systems and driving safety systems:

- 360° Camera (→ page 184)
- ABS (**A**nti-**l**ock **B**raking **S**ystem) (→ page 155)
- Distance Pilot DISTRONIC (→ page 165)
- AIR BODY CONTROL (→ page 174)
- Active Brake Assist (→ page 159)
- Active Lane Keeping Assist (→ page 195)
- ATTENTION ASSIST (→ page 191)
- BAS (**B**rake **A**ssist **S**ystem) (→ page 155)
- EBD (**E**lectronic **B**rake force **D**istribution) (→ page 159)

- ESP® (Electronic Stability Program) (→ page 156)
- DRIVE PILOT (→ page 171)
- HOLD function (→ page 173)
- Steering Pilot (→ page 171)
- Parking Pilot (→ page 186)
- Parking Assist PARKTRONIC (→ page 178)
- Rear view camera (→ page 181)
- Cruise control (→ page 163)
- Blind Spot Assist and Active Blind Spot Assist (→ page 193)

Functions of ABS (anti-lock braking system)

ABS regulates the brake pressure in critical driving situations:

- During braking, the wheels are prevented from blocking, for example due to maximum full-stop braking or insufficient traction of the tires.
- Vehicle steerability while braking is ensured.

- ABS is active from speeds of approx. 5 mph (8 km/h).

If ABS intervenes when braking, you will feel a pulsing in the brake pedal. The pulsating brake pedal can be an indication of hazardous road conditions and can serve as a reminder to take extra care while driving.

System limits

ABS may be impaired or may not function if a malfunction has occurred and the yellow  ABS warning lamp lights up continuously in the instrument cluster after the engine is started.

Function of BAS (Brake Assist System)

⚠ WARNING Risk of an accident caused by a malfunction in BAS (Brake Assist System)

If BAS is malfunctioning, the braking distance may increase in an emergency braking situation.

 Depress the brake pedal with full force in emergency braking situations. ABS prevents the wheels from locking.

BAS supports your emergency braking situation with additional brake force.

If you depress the brake pedal quickly, BAS is activated:

- BAS automatically boosts the brake pressure.
- BAS can shorten the braking distance.
- ABS prevents the wheels from locking.

The brakes will function as usual once you release the brake pedal. BAS is deactivated.

Functions of ESP® (Electronic Stability Program)

⚠ WARNING Risk of skidding if ESP® is malfunctioning

If ESP® is malfunctioning, ESP® cannot carry out vehicle stabilization. In addition, other driving safety systems are switched off.

- ▶ Drive on carefully.
- ▶ Have ESP® checked at a qualified specialist workshop.

⚠ WARNING Risk of skidding if ESP® is deactivated

If you deactivate ESP®, ESP® cannot carry out vehicle stabilization.

- ▶ ESP® should only be deactivated in the following situations.

ESP® monitors and improves driving stability and traction, particularly in the following situations:

- When pulling away on wet or slippery roads.

- When braking.
- In strong sidewinds when you are driving faster than 50 mph (80 km/h).

ESP® can stabilize the vehicle by intervening in the following ways:

- One or more wheels are braked.
- The engine output is adapted according to the situation.

ESP® is deactivated if the ESP® OFF  warning lamp lights up continuously in the instrument cluster:

- Driving stability will no longer be improved.
- Crosswind Assist is no longer active.
- The drive wheels could spin.
- ETS/4ETS traction control is still active.

i Even when ESP® is deactivated, you are still assisted by ESP® when braking.

ESP® is intervening if the ESP®  warning lamp flashes in the instrument cluster:

- Do not deactivate ESP®.

- Only depress the accelerator pedal as far as is necessary.
- Adapt your driving style to suit the current road and weather conditions.

Deactivate ESP® in the following situations to improve traction:

- when using snow chains
- in deep snow
- on sand or gravel

i Spinning the wheels results in a cutting action which provides better grip.

ESP® is deactivated if the  ESP® OFF warning lamp lights up continuously in the instrument cluster.

If the ESP®  warning lamp lights up continuously, ESP® is not available due to a malfunction.

Observe any information which may be displayed in the instrument cluster:

- Warning and indicator lamps (→ page 368)
- Display messages (→ page 326)

ETS/4ETS (Electronic Traction System)

ETS/4ETS traction control is part of ESP®.

ETS/4ETS can improve the vehicle's traction by intervening in the following ways:

- The drive wheels are braked individually if they spin.

- More drive torque is transferred to the wheel or wheels with traction.

Influence of drive programs on ESP®

The drive programs enable ESP® to adapt to different weather and road conditions as well as

the driver's preferred driving style. You can select the drive programs using the DYNAMIC SELECT switch.

ESP® characteristics per drive program

Drive program	ESP® mode	Characteristics
C (Comfort) E (Economy)	ESP® Comfort	<p>These drive programs provide the ideal balance between traction and stability.</p> <p>Select drive program E or C in difficult road conditions, such as in snow or ice, or when the road is wet from rain.</p>
S (Sport)	ESP® Sport	<p>This drive program continues to offer stability but with a sporty setup which allows the enthusiastic driver a more active driving style.</p> <p>Only select drive program S in good road conditions, for example on dry road and clear stretches of road.</p>
S+ (Sport Plus)	ESP® Sport Plus	<p>The vehicle's own understeering and oversteering characteristics are accentuated. This allows a more active driving style to be adopted.</p> <p>Only select drive program S+ in good road conditions, for example on dry road and clear stretches of road.</p>

Activating/deactivating ESP® (Electronic Stability Program)

Multimedia system:

↳ Vehicle ▶ Assistance ▶ Electronic Stability Program

▶ Activate or deactivate the function.

ESP® is deactivated if the  ESP® OFF warning lamp lights up continuously in the instrument cluster.

Observe the information on warning lamps and display messages which may be shown in the instrument cluster.

Functions of ESP® Crosswind Assist

ESP® Crosswind Assist detects sudden gusts of side wind and helps the driver to keep the vehicle in the lane:

- ESP® Crosswind Assist is active at vehicle speeds between 50 mph (80 km/h) and 125 mph (200 km/h) when driving straight ahead or cornering slightly.

- The vehicle is stabilized by means of individual brake application on one side.

Function of EBD (Electronic Brake force Distribution)

EBD is characterized by the following:

- Monitoring and regulating the brake pressure on the rear wheels.
- Improved driving stability when braking, especially on bends.

Function of Active Brake Assist

Active Brake Assist consists of:

- Distance warning function
- Autonomous braking function
- Situation-dependent braking assistance
- **Vehicles with the Driving Assistance package:** Evasive Steering Assist

Active Brake Assist can help you to minimize the risk of a collision with vehicles or pedestrians or to reduce the effects of such a collision.

If Active Brake Assist has detected a risk of collision, you will be warned visually and acoustically.

If you do not react to the visual or acoustic warning, autonomous braking can be initiated in critical situations.

In especially critical situations, Active Brake Assist can initiate autonomous braking directly. In this case, the visual and acoustic warning occurs simultaneously with the braking application.

If you apply the brake yourself in a critical situation or apply the brake during autonomous braking, situation-dependent braking assistance occurs. This increases the brake pressure up to maximum full-stop braking if necessary.

If the autonomous braking function or the situation-dependent braking assistance is triggered, additional preventive measures for occupant protection (PRE-SAFE®) may also be initiated, if the vehicle is equipped with these.

⚠ WARNING Risk of an accident caused by limited detection performance of Active Brake Assist

Active Brake Assist cannot always clearly identify objects and complex traffic situations.

In such cases, Active Brake Assist might:

- give an unnecessary warning or brake the vehicle
- not give a warning or not brake the vehicle.

- ▶ Always pay careful attention to the traffic situation; do not rely on Active Brake Assist alone.
- ▶ Be ready to brake and take evasive action if necessary.

Also observe the system limitations of Active Brake Assist.

The individual subfunctions are available in the following speed ranges:
Distance warning function

The distance warning function issues a warning at speeds:

- From approximately 4 mph (7 km/h), if your vehicle is critically close to a vehicle or pedestrian. An intermittent warning tone sounds and the distance warning lamp lights up in the instrument cluster .

Brake immediately or take evasive action, provided it is safe to do so.

The distance warning function can aid you in the following situations with an intermittent warning tone and a warning lamp:

	Vehicles traveling in front	Stationary vehicles	Crossing vehicles	Crossing pedestrians	Stationary pedestrians
Vehicles without Driving Assistance package	up to approx. 155 mph (250 km/h)	up to approx. 50 mph (80 km/h)	no reaction	up to approx. 37 mph (60 km/h)	no reaction
Vehicles with Driving Assistance package	up to approx. 155 mph (250 km/h)	up to approx. 62 mph (100 km/h)	up to approx. 43 mph (70 km/h)	up to approx. 43 mph (70 km/h)	up to approx. 43 mph (70 km/h)

Autonomous braking function

The autonomous braking function may intervene at speeds starting from approximately 4 mph (7 km/h) in the following situations:

	Vehicles traveling in front	Stationary vehicles	Crossing vehicles	Crossing pedestrians	Stationary pedestrians
Vehicles without Driving Assistance package	up to approx. 124 mph (200 km/h)	up to approx. 31 mph (50 km/h)	no reaction	up to approx. 37 mph (60 km/h)	no reaction
Vehicles with Driving Assistance package	up to approx. 155 mph (250 km/h)	up to approx. 62 mph (100 km/h)	up to approx. 43 mph (70 km/h)	up to approx. 43 mph (70 km/h)	up to approx. 43 mph (70 km/h)

Situation-dependent braking assistance

Situation-dependent braking assistance may intervene at speeds starting from approximately 4 mph (7 km/h) in the following situations:

	Vehicles traveling in front	Stationary vehicles	Crossing vehicles	Crossing pedestrians	Stationary pedestrians
Vehicles without Driving Assistance package	up to approx. 155 mph (250 km/h)	up to approx. 50 mph (80 km/h)	no reaction	up to approx. 37 mph (60 km/h)	no reaction
Vehicles with Driving Assistance package	up to approx. 155 mph (250 km/h)	up to approx. 62 mph (100 km/h)	up to approx. 43 mph (70 km/h)	up to approx. 43 mph (70 km/h)	up to approx. 43 mph (70 km/h)

Canceling a brake application of Active Brake Assist

You can cancel a brake application of Active Brake Assist at any time by:

- Depressing the accelerator pedal fully.
- Releasing the brake pedal.

Active Brake Assist cancels the intervention when at least one of the following conditions is fulfilled:

- You maneuver to avoid an obstacle.
- There is no longer a risk of collision.
- An obstacle is no longer detected in front of your vehicle.

Evasive Steering Assist

Evasive Steering Assist has the following characteristics:

- Can detect stationary or crossing pedestrians.
- Can assist the driver with additional steering assistance if a swerving maneuver is detected.

- Can be activated by an abrupt steering movement during a swerving maneuver.
- Can assist during swerving and straightening of the vehicle.
- Can react from a speed of approximately 12 mph (20 km/h) up to a speed of approximately 43 mph (70 km/h).
- You can prevent the assistance at any time by active steering.

WARNING Risk of an accident despite Evasive Steering Assist

Evasive Steering Assist cannot always clearly identify objects and complex traffic situations.

In addition, the steering support of Evasive Steering Assist is generally not sufficient to avoid a collision.

In such cases Evasive Steering Assist can:

- give an unnecessary warning or provide assistance
- not give a warning or not provide assistance

- ▶ Always pay careful attention to the traffic situation; do not rely on Evasive Steering Assist alone.
- ▶ Be ready to brake and take evasive action if necessary.
- ▶ Prevent the assistance by actively steering in non-critical driving situations.
- ▶ Drive at an appropriate speed if pedestrians are close to the path of your vehicle.

Also observe the system limitations of Evasive Steering Assist.

System limitations

Active Brake Assist may be impaired or may not function in the following situations:

- In snow, rain, fog, heavy spray, if there is glare, in direct sunlight or in greatly varying light conditions.
- If the sensors are dirty, fogged up, damaged or covered.

- If the sensors malfunction due to other radar source interference, for example strong radar reflections in parking garages.
- If a loss of tire pressure or a defective tire has been detected and displayed.

The system may not react correctly:

- In complex traffic stations where objects cannot always be clearly identified.
- To pedestrians or vehicles if they move quickly into the sensor detection range.
- To pedestrians who are hidden by other objects.
- If the typical outline of a pedestrian cannot be distinguished from the background.
- If a pedestrian is not recognized as such, e.g. due to special clothing or other objects.
- On bends with a tight radius.

Setting Active Brake Assist

Multimedia system:

↳ Vehicle ▶ Assistance ▶ Active Brake Assist

Vehicles without Driving Assistance package: The settings can be made after starting the vehicle.

Vehicles with Driving Assistance package: The settings can be made when the ignition is switched on.

 It is recommended that you always leave Active Brake Assist switched on.



The moment of warning or intervention can be adjusted as follows:

- ▶ **Select Warning/Brake Applic.: Early:** your selection is retained when the vehicle is next started.
- ▶ **Select Warning/Brake Appl.: Medium:** your selection is retained when the vehicle is next started.

▶ **Select Warning/Brake Applic.: Late:** your selection is retained when the vehicle is next started.

▶ **Select: Warning/Brake Applic.: Off: Vehicles without Driving Assistance Package:** The autonomous braking function is switched off. When the vehicle is next started, the medium setting is automatically selected.

Vehicles with Driving Assistance Package: The autonomous braking function is switched off. Evasive Steering Assist is unavailable. When the ignition is next started, the medium setting is selected automatically and Evasive Steering Assist is available.

 When Active Brake Assist is deactivated, the  symbol appears in the assistance graphic in the multifunction display.

Speed control cruise control

Function of cruise control

Cruise control accelerates and brakes the vehicle automatically in order to maintain a previously stored speed.

If you accelerate to overtake, for example, the stored speed is not deleted. If you remove your foot from the accelerator pedal after overtaking, cruise control will resume speed regulation back to the stored speed.

You can operate cruise control with the cruise control lever.

If you fail to adapt your driving style, cruise control can neither reduce the risk of an accident nor override the laws of physics. It cannot take into account road, weather or traffic conditions. Cruise control is only an aid. You are responsible for the distance to the vehicle in front, for vehicle speed, for braking in good time and for staying in your lane.

System limitations

Cruise control may be unable to maintain the stored speed on uphill gradients. The stored speed is resumed when the gradient evens out.

Do not use cruise control in the following situations:

- In traffic situations which require frequent changes of speed, e.g. in heavy traffic, on winding roads.

- On slippery roads. Accelerating can cause the drive wheels to lose traction and the vehicle could then skid.
- When visibility is poor.

Operating cruise control

⚠ WARNING Risk of accident due to unknown stored speed

If you call up the stored speed and this is lower than your current speed, the vehicle decelerates.

If you do not know the stored speed, the vehicle could decelerate unexpectedly.

- ▶ Take into account the traffic situation before calling up the stored speed.
- ▶ If the stored speed is not known, store the desired speed again.

Change into a lower gear in good time on long and steep downhill gradients. Take particular note of this when driving a laden vehicle. By doing so, you will make use of the braking effect of the engine. This relieves the load on the brake

system and prevents the brakes from overheating and wearing too quickly.

Requirements

- Cruise control is selected.
- ESP® must be switched on, but not intervening.
- The driving speed must be at least 15 mph (20 km/h).

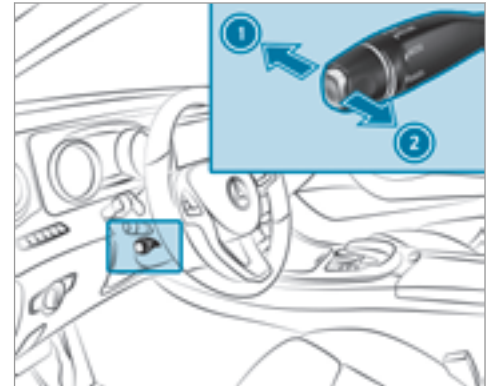

- ▶ Stores current speed ② (once after starting the vehicle).

or

- ▶ Calls up stored speed ②.
- ▶ Deactivates cruise control ①.

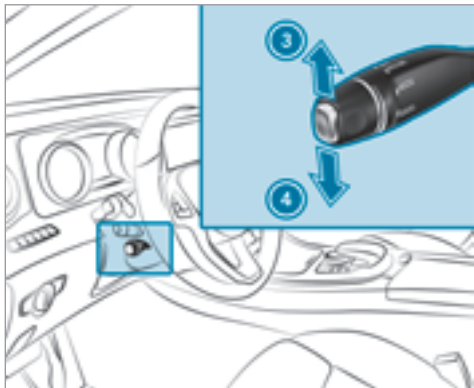

- ▶ Press the lever briefly: stored speed is increased ③ or reduced ④ by 1 mph (1 km/h).

or

- ▶ Press the lever beyond the pressure point: stored speed is increased ③ or reduced ④ by 10 mph (10 km/h).

If cruise control has been deactivated, the current driven speed is adopted with ③ or ④.

- ⓘ If you brake, deactivate ESP® or if ESP® intervenes, cruise control is deactivated. When you switch off the vehicle, the last speed stored is cleared.

Setting the speed limit for winter tires

Multimedia system:

↳ Vehicle ▶ Vehicle Settings ▶ Limit Speed (Winter Tyres)

- ▶ Select the speed or deactivate the function.

Distance Pilot DISTRONIC

Function of Distance Pilot DISTRONIC

Distance Pilot DISTRONIC:

- Maintains the set speed and accelerates or decelerates the vehicle if the distance from the vehicle in front permits.

- Assists you in maintaining the distance from the vehicle in front and can bring your vehicle to a standstill if necessary.
- Brakes your vehicle with up to 50 % of the maximum possible braking power. If greater deceleration performance is required, a visual and acoustic warning is given and you must then intervene yourself.
- **Vehicles with Driving Assistance Package:** Responds in urban speed ranges to stationary vehicles (except bicycles, motorcycles and pedestrians) if conditions are sufficient to enable detection.

If you fail to adapt your driving style, Distance Pilot DISTRONIC can neither reduce the risk of an accident nor override the laws of physics. Distance Pilot DISTRONIC cannot take into account road, weather or traffic conditions. Distance Pilot DISTRONIC is only an aid. You are responsible for the distance to the vehicle in front, for vehicle speed, for braking in good time and for staying in lane.

If all activation conditions are met, you can activate Distance Pilot DISTRONIC during a journey

or while stationary. When Distance Pilot DISTRONIC is activated, a speed is stored which the driver can increase or reduce at any time. The speed can be adjusted between 15 mph (20 km/h) and 120 mph (200 km/h).

Vehicles with the Driving Assistance Package: The speed can be adjusted between 15 mph (20 km/h) and 130 mph (210 km/h).

Vehicles with the Driving Assistance Package: In conjunction with navigation systems, Distance Pilot DISTRONIC prevents prohibited overtaking on the right at speeds over 50 mph (80 km/h) in right-hand traffic and overtaking on the left in left-hand traffic on freeways and high-speed major roads.

If you activate the turn signal indicator to change lanes, the vehicle will accelerate more briskly to the set speed under the following conditions:

- Distance Pilot DISTRONIC is activated.
- If the driving speed is higher than 45 mph (70 km/h).
- If the driven speed drops below the stored speed.

- If the traffic situation in the overtaking lane permits a safe lane change.

Drive program

The DYNAMIC SELECT switch allows you to change the driving style of Distance Pilot DISTRONIC. Depending on which drive program is selected, the driving characteristics can be geared towards fuel economy, comfort or dynamic performance (→ page 140).

System limits

Vehicles with the Driving Assistance Package: Distance Pilot DISTRONIC is active in the 0 mph (0 km/h) to 130 mph (210 km/h) speed range.

The system may be impaired or may not function in the following situations:

- In snow, rain, fog, heavy spray, if there is glare, in direct sunlight or in greatly varying light conditions.
- If the windshield in the area of the camera is dirty, fogged up, damaged or covered.
- If the radar sensors are dirty or covered.

Do not use Distance Pilot DISTRONIC in the following situations:

- In road and traffic conditions which do not allow you to maintain a constant speed, e.g. in heavy traffic or on winding roads.
- On slippery roads. Braking or accelerating can cause the drive wheels to lose traction and the vehicle could then skid.
- When there is poor visibility, e.g. due to fog, heavy rain or snow.
- In parking garages or at toll stations.
- On roads with steep uphill or downhill gradients.

Tips

Pay particular attention in the following traffic situations. In such situations, brake if necessary. Distance Pilot DISTRONIC is then deactivated:

- When cornering, entering and exiting a bend.
- When not driving in the center of the lane.
- When other vehicles are changing lane.
- If there are narrow vehicles.

- If there are obstacles and stationary vehicles.
- If there are crossing vehicles, pedestrians, motorcyclists or cyclists.

Display of Distance Pilot DISTRONIC in the assistance graphic and in the speedometer





- 1 Vehicle ahead
- 2 Distance indicator
- 3 Set specified distance
- 4 Own vehicle



- 1 Speed of vehicle ahead
- 2 Stored speed

Displays in the multifunction display

When activating Distance Pilot DISTRONIC or when changing the stored speed, the new stored speed is shown for around five seconds in the  multifunction display 50 mph (70 km/h).

When Distance Pilot DISTRONIC is active, the set stored speed is displayed next to the  symbol. When distance control is active, the symbol is shown in green.

Vehicles with the Driving Assistance Package: On freeways or high-speed major roads the

 symbol is displayed cyclically when the vehicle is ready to pull away.

Operating Distance Pilot DISTRONIC

⚠ WARNING Risk of accident if detection function of Distance Pilot DISTRONIC is impaired

The Distance Pilot DISTRONIC does not react:

- To people or animals.
- To stationary obstacles on the road, e.g. stopped or parked vehicles (vehicles without the Driving Assistance Package).
- To stationary obstacles on the road, e.g. stopped or parked vehicles, if conditions are not sufficient to enable detection (vehicles with the Driving Assistance Package).
- To oncoming vehicles and crossing traffic.

As a result, Distance Pilot DISTRONIC may neither give warnings nor intervene in such situations.

- ▶ Always carefully observe the traffic conditions and be ready to brake at all times.

⚠ WARNING Risk of accident due to limited detectability of road users and traffic situations

Distance Pilot DISTRONIC cannot always clearly identify other road users and complex traffic situations.

In these conditions, Distance Pilot DISTRONIC may:

- Give an unnecessary warning and then brake the vehicle.
 - Neither give a warning nor intervene.
 - Accelerate or brake unexpectedly.
- ▶ Continue driving with care and be ready to brake, particularly if Distance Pilot DISTRONIC warns you.

⚠ WARNING Risk of accident due to insufficient deceleration by Distance Pilot DISTRONIC

Distance Pilot DISTRONIC brakes your vehicle with up to 50 % of the maximum possible braking power. If this deceleration is not sufficient, Distance Pilot DISTRONIC alerts you with a visual and acoustic warning.

- ▶ Apply the brakes yourself in these situations and try to take evasive action.

⚠ WARNING Risk of accident due to Distance Pilot DISTRONIC still being activated when you leave the driver's seat

If you leave the driver's seat while the vehicle is being braked by Distance Pilot DISTRONIC only, it can roll away in the following situations:

- If there is a malfunction in the system or in the power supply.

- If Distance Pilot DISTRONIC is deactivated with the cruise control lever, for example by a vehicle occupant or from outside the vehicle.
- If the electrics in the engine compartment, the battery or the fuses are tampered with.
- If the battery is disconnected.
- If the vehicle is accelerated, for example by a vehicle occupant.

- ▶ Always deactivate Distance Pilot DISTRONIC and secure the vehicle to prevent it from rolling away before you leave the driver's seat.

⚠ WARNING Risk of accident due to unknown stored speed

If you call up the stored speed and this is lower than your current speed, the vehicle decelerates.

If you do not know the stored speed, the vehicle could decelerate unexpectedly.

- ▶ Take into account the traffic situation before calling up the stored speed.
- ▶ If the stored speed is not known, store the desired speed again.

⚠ WARNING Risk of accident due to unexpected acceleration by Distance Pilot DISTRONIC

If Distance Pilot DISTRONIC no longer detects a vehicle in front, it may unexpectedly accelerate to the speed stored.

- This speed may be too high for a turning lane or an exit lane.
- If driving in the right lane, this speed may be so high that you pass vehicles driving on the left (in countries where traffic drives on the right).
- If driving in the left lane, this speed may be so high that you pass vehicles driving on the right (in countries where traffic drives on the left).

Always carefully observe the traffic conditions and be ready to brake at all times.

⚠ WARNING Risk of accident due to Distance Pilot DISTRONIC pulling away automatically

If Distance Pilot DISTRONIC performs an automatic driving-off procedure, the vehicle may accelerate unexpectedly.

Where necessary, brake the vehicle yourself and take evasive action.

Requirements

- The vehicle's engine or must be switched on.
- The electric parking brake must be released.
- Parking Pilot is not being used to park the vehicle or to exit from a parking space.
- ESP[®] must be switched on, but not intervening.
- The transmission must be in position **D**.
- The driver door, front passenger door and the rear doors must be closed.

- The engine hood must be closed.

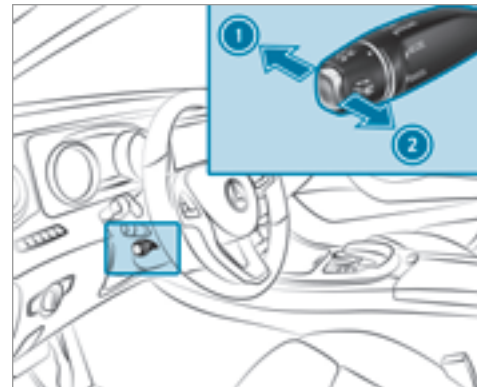

- ▶ Remove your foot from the accelerator pedal.
 - ▶ To store current speed ②. Your vehicle adapts its speed to that of the vehicle in front, but only up to the stored speed.
- or
- ▶ To call up stored speed ②.

- ▶ To deactivate Distance Pilot DISTRONIC ①.

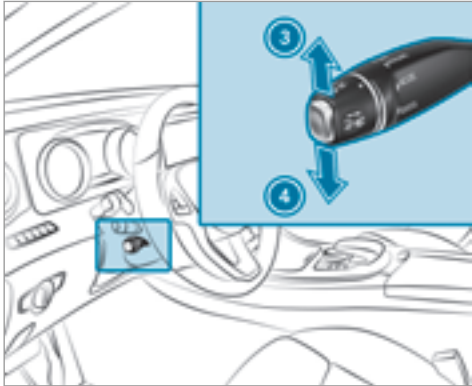

- ▶ To increase ③ or reduce ④ the speed.

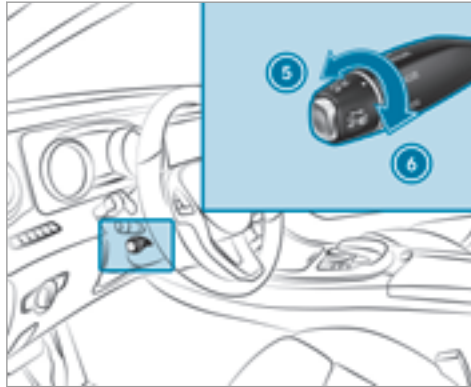

- ▶ To reduce ⑤ or increase ⑥ the specified distance from the vehicle in front.

Pulling away with Distance Pilot DISTRONIC

Requirement: a speed must have been previously stored.

- ▶ Remove your foot from the brake pedal.
- ▶ Briefly pull the cruise control lever towards you ②.

or

- ▶ Accelerate briefly.
Your vehicle pulls away and adapts its speed to that of the vehicle in front. If no vehicle is detected in front, your vehicle accelerates to the set speed.

Collision warning

If Distance Pilot DISTRONIC is unable to sufficiently decelerate the vehicle in order to prevent it from approaching the vehicle in front, you will be warned visually and acoustically. An intermittent warning tone will then sound and the distance warning lamp will light up in the instrument cluster.

- ▶ Brake immediately in order to increase the distance from the vehicle in front.

or

- ▶ Take evasive action provided it is safe to do so.

Function of DRIVE PILOT

The DRIVE PILOT function is available only on vehicles with the Driving Assistance package.

DRIVE PILOT includes the following driving and driving safety systems:

- Steering Pilot (→ page 171)
- Distance Pilot DISTRONIC (→ page 165)

Steering Pilot

Function of Steering Pilot

Steering Pilot is only available for vehicles with the Driving Assistance Package.



- Steering Pilot is operational at speeds up to 130 mph (210 km/h) and helps you to stay in the center of the lane by means of moderate steering interventions.
- It uses as a reference the vehicle in front or the lane markings, depending on the driven speed.
- Steering Pilot requires you as the driver, to keep your hands on the steering wheel at all

times so that you are able to intervene at any time to correct the course of the vehicle and keep it in lane.

- Steering Pilot can be overridden at any time by steering the vehicle yourself.
- If the system detects that there are no lane markings, it uses the vehicle ahead as a reference up to a speed of 80 mph (130 km/h).
- When the system is actively steering, the  symbol is shown in green in the multi-function display.

Steering Pilot system limits

Steering Pilot has a limited steering torque for lateral guidance. In some cases, the steering intervention is not sufficient to keep the vehicle in the lane.

If detection of lane markings and vehicles ahead is impaired, Steering Pilot switches to passive mode. The system provides no support in this case. During the transition from the active to passive status, the  symbol is shown as enlarged and flashes yellow. Once the system is passive the  symbol is grayed out in the multifunction display.

The system may be impaired or may not function in the following situations:

- If there is poor visibility, e.g. due to insufficient illumination of the road, or due to snow, rain, fog or spray.
- If there is glare, e.g. from oncoming traffic, direct sunlight or reflection from other vehicles (e.g. if the road surface is wet).
- If the windshield is dirty, fogged up, damaged or covered, for instance by a sticker, in the vicinity of the camera.
- If no, or several, unclear lane markings are present for one lane, e.g. in a construction area.
- If the lane markings are worn away, dark or covered up, e.g. by dirt or snow.
- If the distance to the vehicle in front is too small and the lane markings thus cannot be detected.
- If the lane markings change quickly, e.g. lanes branch off, cross one another or merge.
- If the road is narrow and winding.

- if there are highly variable shade conditions on the road.
- If there are obstacles such as traffic guidance posts on the lane or projecting out into the lane.

The system does not provide assistance in the following conditions:

- On very sharp bends.
- When towing a trailer.
- If you actively change lane without switching on the turn signal indicator.

Information on the Steering Pilot

Steering Pilot is only an aid. You are responsible for the distance to the vehicle in front, for vehicle speed, for braking in good time and for staying in lane. Before changing lanes, make sure that the neighboring lane is free (shoulder view).

Steering and contact detection

Steering Pilot requires you as the driver, to keep your hands on the steering wheel at all times so that you are able to intervene at any time to correct the course of the vehicle and keep it in lane.

The driver must expect a change from active to passive mode or vice versa at any time.



If you are not steering yourself or if you take your hands off the steering wheel for a prolonged period of time, the system will, depending on the situation, first alert you with a visual warning.  appears in the multifunction display. If you are still not steering the vehicle yourself or if you have not taken hold of the steering wheel, a warning tone sounds in addition to the warning message to remind you to take control of the vehicle.

The warning message does not appear or disappears if one of the following conditions are met:

- The driver steers the vehicle.
- The driver presses a steering wheel button or operates Touch Control.

Active Emergency Stop Assist

If the driver continues to ignore the acoustic warning, Distance Pilot DISTRONIC reduces the speed. If the driver still does not respond, the vehicle is decelerated in stages to a standstill.

The driver can cancel the deceleration at any time by performing one of the following actions:

- Steering
- Braking or accelerating
- Pressing a steering wheel button or operating Touch Control
- Activating or deactivating Steering Pilot or Distance Pilot DISTRONIC

The driver must be ready to take control of the vehicle at any time.

Activating Steering Pilot

Requirements

- ESP® must be switched on, but not intervening.
- Distance Pilot DISTRONIC must be activated.

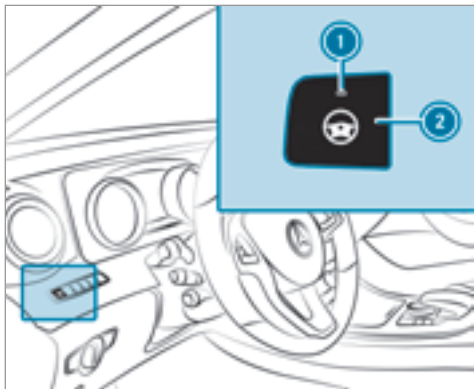

► If indicator lamp ① is off: press button ②.

Information on Hill Start Assist

Hill Start Assist holds the vehicle when pulling away on a hill under the following conditions:

- The transmission is in position **D** or **R**.
- The electric parking brake is released.

⚠ WARNING Risk of accident and injury caused by the vehicle rolling away

After a short time, Hill Start Assist no longer holds the vehicle and it can roll away.

► Therefore, swiftly move your foot from the brake pedal to the accelerator pedal. Never attempt to leave the vehicle if it is being held by Hill Start Assist.

HOLD function

HOLD function

The HOLD function holds the vehicle at a standstill without requiring you to depress the brake pedal, such as when pulling away on steep slopes.

System limits

The incline must not be greater than 30%.

Activating/deactivating the HOLD function

⚠ WARNING Risk of an accident due to the HOLD function being active when you leave the vehicle

If you leave the vehicle while only the HOLD function is braking the vehicle, the vehicle can roll away in the following situations:

- If there is a malfunction in the system or in the power supply.
- If the HOLD function is deactivated by depressing the accelerator pedal or the brake pedal, e.g. by a vehicle occupant.
- If the electrics in the engine compartment, the battery or the fuses are tampered with.
- If the battery is disconnected.

► Always deactivate the HOLD function and secure the vehicle against rolling away before leaving the vehicle.

! NOTE Damage from automatic braking

If Active Brake Assist, Distance Pilot DISTRONIC or the HOLD function is activated, the vehicle brakes automatically in certain situations.

To avoid damage to the vehicle, deactivate these systems in the following or similar situations:

- ▶ During towing
- ▶ In a car wash

Requirements

- The vehicle is stationary.
- The driver's door is closed or the seat belt on the driver's side is fastened.
- The engine is running or has been automatically switched off by the ECO start/stop function.
- The electric parking brake is released.
- Distance Pilot DISTRONIC is not activated.
- **Vehicles with automatic transmission:**
The transmission is in position **D**, **R** or **N**.

Activating the HOLD function

- ▶ Depress the brake pedal and after a short time depress further until the **HOLD** display appears in the multifunction display.
- ▶ Release the brake pedal.

Deactivating the HOLD function

- ▶ Depress the accelerator pedal to pull away.
or
- ▶ Depress the brake pedal until the **HOLD** display disappears from the multifunction display.

The HOLD function is deactivated in the following situations:

- If Distance Pilot DISTRONIC has been activated.
- **Vehicles with automatic transmission:**
When transmission position **P** is selected.
- When the vehicle is secured with the electric parking brake.

In the following situations, the vehicle is held by the transmission position **P** or by the electric parking brake:

- When the seat belt is unfastened and the driver's door is opened.
- When the engine is switched off.
- When there is a malfunction in the system or if the power supply is insufficient.

AIR BODY CONTROL**AIR BODY CONTROL function**

AIR BODY CONTROL is an air suspension system with variable damping for improved driving comfort. The all-round level control system ensures the best possible suspension and constant ground clearance, even with a laden vehicle. When driving at speed, the vehicle is lowered automatically to improve driving safety and to reduce fuel consumption. The option of manually adjusting the vehicle level is also available.

AIR BODY CONTROL comprises:

- Air suspension with variable spring rate
- Automatic level control system

- Speed-dependent lowering to reduce fuel consumption
- Manual level adjustment
- ADS PLUS (Adaptive Damping System with constant damping force adjustment)
- DYNAMIC SELECT switch and level button

Available suspension settings

Drive program	Characteristics
C (Comfort)	<ul style="list-style-type: none"> • Comfortable suspension tuning • Normal level • When driving at speeds above 78 mph (125 km/h), the vehicle is lowered by 0.6 in (15 mm) • When driving at speeds below 50 mph (80 km/h), the vehicle is raised again by 0.6 in (15 mm)
E (Economy)	<ul style="list-style-type: none"> • Comfortable suspension tuning • The vehicle is lowered by 0.6 in (15 mm) compared to the normal level • The vehicle is not lowered any further if you are traveling at higher speeds

Drive program	Characteristics
S (Sport)	<ul style="list-style-type: none"> • Firmer suspension tuning • The vehicle is lowered by 0.6 in (15 mm) compared to the normal level • The vehicle is not lowered any further if you are traveling at higher speeds
S+ (Sport Plus)	<ul style="list-style-type: none"> • Even firmer suspension tuning • The vehicle is lowered by 0.6 in (15 mm) compared to the normal level • The vehicle is not lowered any further if you are traveling at higher speeds

Setting the vehicle level

⚠ WARNING Risk of accident because vehicle level is too high

If you drive at a higher vehicle level, the driving characteristics may be impaired due to the higher vehicle center of gravity.

The vehicle may tip over more quickly on a bend, for example.

▶ Always select as low a vehicle level as possible and adapt your driving style accordingly.

⚠ WARNING Risk of entrapment from vehicle lowering

When lowering the vehicle, people could become trapped if their limbs are between the vehicle body and the tires or underneath the vehicle.

▶ Make sure no one is underneath the vehicle or in the immediate vicinity of the wheel arches when you lower the vehicle.

⚠ WARNING Risk of entrapment from vehicle lowering

Vehicles with AIR BODY CONTROL or level control system: When you unload luggage or leave the vehicle, the vehicle first rises slightly and then returns to the set level shortly afterwards.

You or anyone else in the vicinity of the wheel arches or the underbody could thus become trapped.

The vehicle can also be lowered after being locked.

- ▶ When leaving the vehicle, make sure that nobody is in the vicinity of the wheel arches or the underbody.

Requirements

- The vehicle's engine must be switched on.
- The vehicle must not be moving faster than 37 mph (60 km/h).

Raising the vehicle

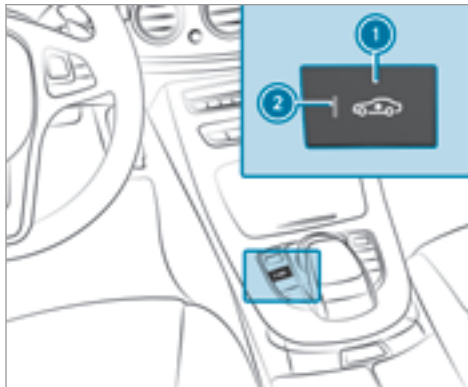

- ▶ Press button ①.
Indicator lamp ② lights up.
The vehicle is raised by 1 in (25 mm) compared to the normal level.

Your selection is saved.

- ⓘ In drive program **All-Terrain**, the vehicle cannot be raised further using button ①.

The vehicle is lowered again in the following situations:

- When driving faster than 62 mph (100 km/h).
- When driving between 50 mph (80 km/h) and 62 mph (100 km/h) for approximately three minutes.
- After selecting a drive program using the DYNAMIC SELECT switch.

The vehicle is adjusted to the height of the last active drive program.

Lowering the vehicle

- ▶ Press button ①.
Indicator lamp ② goes out. The vehicle is adjusted to the height of the last active drive program.

Parking Assist PARKTRONIC

Functions of Parking Assist PARKTRONIC

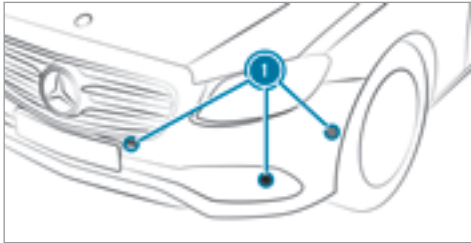

Parking Assist PARKTRONIC is an electronic parking assistance system with ultrasound. It monitors the area around your vehicle using six sensors ① in the front bumper and six sensors in the rear bumper. Parking Assist PARKTRONIC indicates visually and audibly the distance between your vehicle and an object.

Parking Assist PARKTRONIC is only an aid. It is not a substitute for your attention to the surroundings. The responsibility for safe maneuvering and parking remains with you. Make sure that there are no persons, animals or objects in

the maneuvering area while maneuvering and parking in/exiting parking spaces.

In the standard setting, an intermittent warning tone sounds from a distance of approximately 1.0 ft (0.3 m) to an obstacle. A continuous tone sounds from a distance of approximately 0.7 ft (0.2 m). You can set the warning tone in the multimedia system so that it will sound earlier at a greater distance of approximately 3.3 ft (1.0 m) (→ page 180).

If Parking Assist PARKTRONIC is deactivated, Parking Pilot is unavailable.

Parking Assist PARKTRONIC display in the multimedia system

If Parking Pilot is deactivated and an obstacle is detected in the path of the vehicle, a pop-up window for Parking Assist PARKTRONIC ① appears in the multimedia system at speeds up to approximately 6 mph (10 km/h).

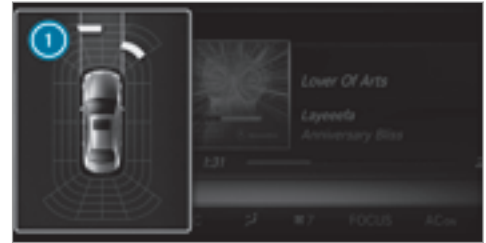

Vehicles with Parking Pilot and rear view camera



Vehicles with Parking Pilot and 360° Camera

System limitations

Parking Assist PARKTRONIC does not necessarily take into account the following obstacles:

- Obstacles below the detection range, e.g. persons, animals or objects.
- Obstacles above the detection range, e.g. overhanging loads, overhangs or loading ramps of trucks.

The sensors must be free of dirt, ice and slush. Otherwise, they may not function correctly. Clean the sensors regularly, taking care not to scratch or damage them.

Vehicles with trailer hitch: Parking Assist PARKTRONIC is deactivated for the rear zone when you establish an electrical connection between your vehicle and a trailer.

Passive side impact protection

Passive side impact protection is an additional Parking Assist PARKTRONIC function which warns the driver about obstacles at the side of the vehicle. A warning is issued when obstacles are detected between the front and rear detection range. In order for an object to be detected,

the sensors in the front and rear bumper must detect the object while you are driving past it.

During the parking procedure or maneuvering, objects are detected as the vehicle drives past. If you steer in the direction of a detected obstacle and there is a risk of a lateral collision, a warning is issued. The lateral segments light up orange or red, depending on the distance to the obstacle.

Color	Lateral distance in cm
Red	< 30
Orange	30 - 60

In order for lateral front or rear segments to be displayed, the vehicle must first travel a distance of at least half of the vehicle length. Once the vehicle has traveled the length of the vehicle, all of the lateral front and rear segments can be displayed.



- ① Parking Assist PARKTRONIC is only operational in the front and rear
- ② Parking Assist PARKTRONIC is operational and can also warn the driver about obstacles at the side of the vehicle
- ③ Obstacle detected at the front right (orange) and rear (red)

When you switch off the ignition, the stored obstacles are deleted. After the engine is restarted, obstacles must be detected again, before a new warning can be issued.

System limitations

The system limitations for Parking Assist PARKTRONIC apply for passive side impact protection.

Objects placed next to the vehicle, or pedestrians who approach the side of the vehicle will not be detected.

Deactivating/activating PARKTRONIC

! **NOTE** Risk of an accident from objects at close range

Parking Assist PARKTRONIC may not detect certain objects at close range.

▶ When parking the vehicle, pay particular attention to any objects which are above or below the sensors, e.g. flowerpots or drawbars. The vehicle or other objects could otherwise be damaged.

If indicator lamp **1** is not lit, Parking Assist PARKTRONIC is active. If the indicator lamp is lit or the  symbol appears in the multifunction display, Parking Assist PARKTRONIC is not active.

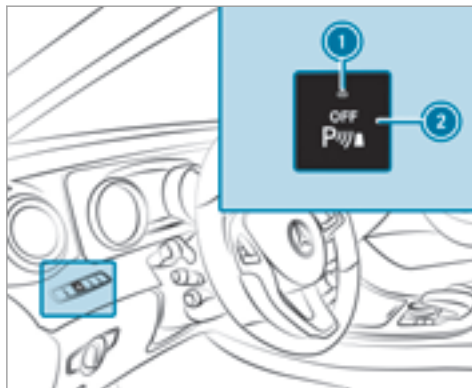

- ▶ Press button **2**.
- i** Depending on the vehicle's equipment, the button may also be located in the center console.
- i** Parking Assist PARKTRONIC is automatically activated when the vehicle is started.

Adjusting the warning tones of Parking Assist PARKTRONIC

Multimedia system:

➔ [Vehicle](#) ➔ [System Settings](#) ➔ [Parking Pilot](#) ➔ [Set Warning Tones](#)

Adjusting the volume of the warning tones

- ▶ Select [Warning Tone Volume](#).
- ▶ Adjust the value.

Adjusting the pitch of the warning tones

- ▶ Select [Warning Tone Pitch](#).
- ▶ Adjust the value.

Specifying the starting point for the warning tones

You can specify whether the Parking Assist PARKTRONIC warning tones should commence when the vehicle is further away from an obstacle.

- ▶ Select [Warn Early](#).
- ▶ Activate or deactivate the function.

Activating/deactivating audio fadeout

You can specify whether the volume of a media source in the multimedia system is to be reduced when Parking Assist PARKTRONIC gives an audible warning.

- ▶ Select **Audio Fadeout During Warning Tones**.
- ▶ Activate or deactivate the function.

Reversing camera

Function of the rear view camera

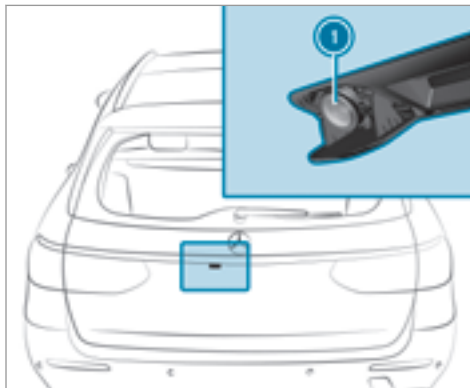

When you engage reverse gear, the image from rear view camera ① is displayed in the multimedia system. Dynamic guide lines show the path the vehicle will take with the steering wheel in its current position. This helps you to orientate

yourself and to avoid obstacles when backing up.

The rear view camera is only an aid. It is not a substitute for your attention to the surroundings. The responsibility for safe maneuvering and parking remains with you. Make sure that, when parking or maneuvering, there are no persons, animals or other objects in the maneuvering area.

You can select from the following views:

- Normal view
- Wide-angle view
- Trailer view

The area behind the vehicle is displayed as a mirror image, as in the inside rear-view mirror.

System limitations

The rear view camera will not function or will only partially function in the following situations:

- If the trunk lid or tailgate is open.
- If there is heavy rain, snow or fog.
- If the light conditions are poor, e.g. at night.

- If the camera lens is obstructed, dirty or fogged up. Observe the notes on cleaning the rear view camera (→ page 260).
- If the rear of your vehicle is damaged. In this case, have the camera position and setting checked at a qualified specialist workshop.

The field of vision and other functions of the rear view camera may be restricted due to additional accessories on the rear of the vehicle (e.g. license plate bracket or bicycle rack).

Vehicles without Parking Pilot

The following camera views are available in the multimedia system:



Normal view

- ① Yellow guide line at a distance of approximately 13 ft (4.0 m) from the rear area
- ② White guide line without turning the steering wheel, vehicle width including the outside mirrors (static)
- ③ Yellow guide line, vehicle width (surface area driven over) depending on the current steering wheel angle (dynamic)
- ④ Yellow lane marking the course the tires will take at the current steering wheel angle (dynamic)



- ⑤ Yellow guide line at a distance of approximately 3.3 ft (1.0 m) from the rear area
- ⑥ Vehicle center axis (locating aid)
- ⑦ Bumper
- ⑧ Red guide line at a distance of approximately 12 in (0.3 m) from the rear area



Wide-angle view

Vehicles with Parking Pilot

The following camera views are available in the multimedia system:



Normal view

- ① Yellow lane marking the course the tires will take at the current steering wheel angle (dynamic)
- ② Yellow guide line, vehicle width (surface area driven over) depending on the current steering wheel angle (dynamic)
- ③ Red guide line at a distance of approximately 12 in (0.3 m) from the rear area
- ④ Yellow warning display of Parking Assist PARKTRONIC: obstacles are at a distance of between approximately 2.0 ft (0.6 m) and 3.3 ft (1.0 m)

- ⑤ Red warning display of Parking Assist PARKTRONIC: obstacles are very close (approximately 1.0 ft (0.3 m) or less)
 - ⑥ Orange warning display of Parking Assist PARKTRONIC: obstacles are a medium distance away (between approximately 1.0 ft (0.3 m) and 2.0 ft (0.6 m))
- ⓘ If the entire system fails, the inner segments of the warning display are shown in red. The indicator lamp on the PARKTRONIC button lights up and the  symbol appears in the multifunction display.
- If the system fails in the rear:
- The rear segments are shown in red when backing up.
 - The rear segments are hidden when driving forwards.

When Parking Pilot is active, the lanes are displayed in green.

If Parking Assist PARKTRONIC is deactivated, the warning display fades out.



Wide-angle view

Opening the camera cover of the rear view camera

Multimedia system:

↳ [Vehicle](#) ▶ [System Settings](#) ▶ [Parking Pilot](#) ▶ [Open Camera Cover](#)

▶ Activate or deactivate the function.

360° camera

Function of the 360° Camera

The 360° Camera is a system that consists of four cameras. The cameras cover the immediate vehicle surroundings. The system assists you,

e.g. when parking or at exits with reduced visibility.

The 360° Camera is only an aid. It is not a substitute for your attention to the surroundings. The responsibility for safe maneuvering and parking remains with you. Make sure that, when parking or maneuvering, there are no persons, animals or other objects in the maneuvering area.

The system evaluates images from the following cameras:

- Rear view camera
- Front camera
- Two side cameras in the outside mirrors

Views of the 360° Camera

You can select from different views:



- ① Wide-angle view, front
- ② Top view with image from the front camera
- ③ Top view with images from the side cameras in the outside mirrors
- ④ Wide-angle view, rear
- ⑤ Top view with image from the rear view camera
- ⑥ Top view with trailer view

Top view



- ① Lane indicating the route the vehicle will take with the steering wheel in its current position
- ② Yellow warning display of Parking Assist PARKTRONIC: obstacles at a distance of approximately 3.3 ft (1.0 m) or less
- ③ Your vehicle from above

If the distance to the object lessens, the color of the warning display changes ②. From a distance of approximately 2.0 ft (0.6 m) the warning display is shown in orange. From a distance of approximately 1.0 ft (0.3 m) the warning display is shown in red.

When Parking Assist PARKTRONIC is operational and no object is detected, the segments of the warning display are shown in gray.

① If the entire system fails, the inner segments of the warning display are shown in red. The indicator lamp on the PARKTRONIC button lights up and the  symbol appears in the multifunction display.

If the system fails at the rear:

- the rear segments are shown in red when backing up.
- the rear segments are hidden when driving forwards.

If Parking Assist PARKTRONIC is deactivated, the warning display fades out.

Guide lines



- ① Yellow lane marking the course the tires will take at the current steering wheel angle (dynamic)
 - ② Yellow guide line, vehicle width (driven surface) depending on the current steering wheel angle (dynamic)
 - ③ Red guide line at a distance of approximately 12 in (0.3 m) from the rear area
 - ④ Mark at a distance of approx. 3.3 ft (1.0 m)
- ① When Parking Pilot is active, the lanes are displayed in green.

The guide lines in the multimedia system display show the distances to your vehicle. The distances only apply to road level. In trailer mode, the guide lines are shown at the level of the trailer hitch.

System limitations

The 360° Camera will not function or will only partially function in the following situations:

- If the doors are open.
- The side mirrors are folded in.
- If the trunk lid or tailgate is open.
- If there is heavy rain, snow or fog.
- If the ambient light is poor, e.g. at night.
- If the camera lens is obstructed, dirty or fogged up.
- If the vehicle components in which the cameras are installed are damaged. In this event, have the camera position and setting checked at a qualified specialist workshop.

Do not use the 360° Camera under such circumstances. You could otherwise injure others or collide with objects when parking the vehicle.

On vehicles with height-adjustable suspension or if the vehicle is carrying a heavy load, leaving the standard height can result in inaccuracies in the guide lines and in the display of the generated images, depending on technical conditions.

The field of vision and other functions of the camera system may be restricted due to additional accessories on the rear of the vehicle (e.g. license plate bracket, bicycle rack).

See the notes on cleaning the 360° Camera (→ page 260).

Selecting a view for the 360° Camera

The [Activation by R gear](#) function is selected in the multimedia system.

- ▶ Engage reverse gear.
- ▶ In the multimedia system, select the desired view.



Opening the camera cover of the rear view camera (Parking Pilot)

Multimedia system:

- ▶ [Vehicle](#) ▶ [System Settings](#) ▶ [Parking Pilot](#) ▶ [Open Camera Cover](#)
- ▶ Activate or deactivate the function.

Parking Pilot

Function of Parking Pilot

Parking Pilot is an electronic parking assistance system which uses ultrasound and is automatically activated during forward travel. The system is operational at speeds of up to approximately 22 mph (35 km/h). When all the conditions are fulfilled, the  symbol appears in the multifunction display and the system automatically searches for and measures parking spaces on both sides of the vehicle parallel and perpendicular to the direction of travel. If Parking Pilot is activated, suitable parking spaces are displayed in the multimedia system. The  symbol appears in the multifunction display. The arrows show which side of the road free parking spaces are located.

The parking space and, if necessary, the parking direction can be selected as desired. Parking Pilot calculates a suitable vehicle path and assists you in the parking and exiting procedure.

Vehicles with automatic transmission: Parking Pilot changes gear, accelerates, brakes and steers the vehicle.

Parking Pilot is only an aid. It is not a substitute for your attention to the surroundings. You are always responsible for safe maneuvering, parking and exiting a parking space. Make sure that no persons, animals or objects etc. are in the maneuvering range.

Parking Pilot is canceled if, among other things, one of the following actions is carried out:

- You switch off Parking Assist PARKTRONIC.
- You switch off Parking Pilot.
- You begin steering.
- You apply the parking brake.
- **Vehicles with automatic transmission:** You engage **P**.
- ESP® intervenes.

Parking Pilot system limits

Objects located above or below the detection range of Parking Pilot are not detected when the parking space is being measured. These are also not taken into account when the parking maneuver is calculated, for example, overhanging loads, overhangs or loading ramps of trucks or the boundaries of the parking space. In some

circumstances, Parking Pilot may therefore guide you into the parking space prematurely.

⚠ WARNING Risk of accident due to objects located above or below the detection range of Parking Pilot

If there are objects above or below the detection range, the following situations may arise:

- Parking Pilot may steer too early.
- **Vehicles with automatic transmission:** The vehicle may not stop in front of these objects.

This could cause a collision.

▶ In these situations, do not use Parking Pilot.

Snowfall or heavy rain may lead to a parking space being measured inaccurately. Parking spaces that are partially occupied by trailer drawbars might not be identified as such or be measured incorrectly. Only use Parking Pilot on level, high-grip ground.

Do not use Parking Pilot, for example, in the following situations:

- In extreme weather conditions such as ice or packed snow or in heavy rain.
- If you are transporting a load that protrudes beyond the vehicle.
- If the parking space is on a steep downhill or uphill gradient.
- If you have installed snow chains.

Parking Pilot may also display parking spaces that are not suitable for parking, for example:

- Parking spaces where parking is prohibited.
- Parking spaces on unsuitable surfaces.

Parking Pilot will not assist you with parking spaces at right angles to the direction of travel in the following situations:

- If two parking spaces are located immediately next to each other.
- If the parking space is directly next to a low obstacle such as a low curb.

Parking Pilot will not assist you with parking spaces parallel or at right angles to the direction of travel in the following situations:

- If the parking space is on a curb.
- If the parking space is bordered by an obstacle, for example, a tree, a post or a trailer.

Parking with Parking Pilot

- i** Depending on the vehicle's equipment, the button may also be located at a different position in the center console.

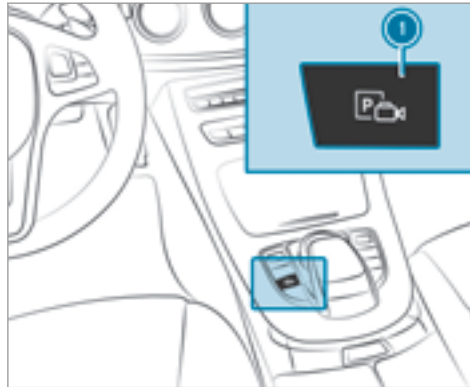

- ▶ Press button **1**.
The Parking Pilot view appears on the display of the multimedia system. Area **2** displays detected parking spaces **4** and vehicle path **3**.

- i** Vehicle path **3** shown on the multimedia system display may differ from the actual vehicle path.



- ▶ If you have driven past a suitable parking space: bring the vehicle to a standstill.
- ▶ Select desired parking space **4**.
- ▶ Where necessary, select the parking direction: forwards or reverse.
Vehicle path **3** is shown, depending on the selected parking space and parking direction.
- ▶ Confirm the selected parking space.

⚠ WARNING Risk of accident due to vehicle swinging out while parking or pulling out of a parking space

While parking or pulling out of a parking space, the vehicle swings out and can drive onto areas of the oncoming lane.

This could cause you to collide with objects or other road users.

- ▶ Pay attention to objects and other road users.
- ▶ Where necessary, stop the vehicle or cancel the parking procedure with Parking Pilot.

- ▶ If, for example, the **Engage Reverse Gear** message appears in the display of the multimedia system: select the corresponding transmission position.

Vehicles with automatic transmission:

The vehicle drives into the selected parking space.

On completion of the parking procedure, the **Parking Pilot Finished, Take Control of the Vehi-**

cle display message appears. Further maneuvering may still be necessary.

- ▶ After completion of the parking procedure, safeguard the vehicle against rolling away. When required by legal requirements or local conditions: turn the wheels towards the curb.

i Vehicles with automatic transmission: You can stop the vehicle and change the transmission position during the parking procedure. The system then calculates a new vehicle path. The parking procedure can then be continued. If no new vehicle path is available, the transmission position will be changed again. If the vehicle has not yet reached the parking space, changing gear will result in the parking procedure being canceled.

Exiting a parking space with Parking Pilot

Requirement:

You can only exit a parking space with Parking Pilot if you have previously parked the vehicle with Parking Pilot.

Please note that you are responsible for the vehicle and surroundings during the entire parking procedure.

- ▶ Start the vehicle.

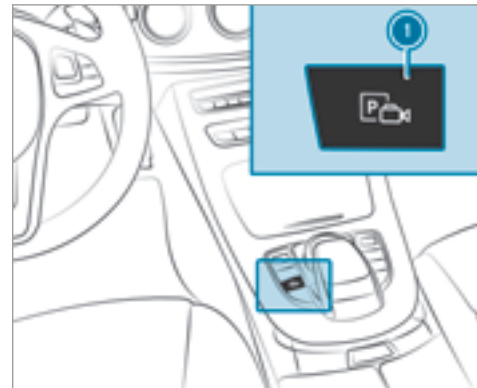

- ▶ Press button **1**. The Parking Pilot view appears on the display of the multimedia system.

- ▶ If the vehicle has been parked at right angles to the direction of travel: in area ②, select direction of travel ③.



- ① The vehicle path shown on the multimedia system display may differ from the actual vehicle path.
- ▶ Confirm to start the exiting process.

⚠ WARNING Risk of accident due to vehicle swinging out while parking or pulling out of a parking space

While parking or pulling out of a parking space, the vehicle swings out and can drive onto areas of the oncoming lane.

This could cause you to collide with objects or other road users.

- ▶ Pay attention to objects and other road users.
- ▶ Where necessary, stop the vehicle or cancel the parking procedure with Parking Pilot.

- ▶ If, for example, the **Engage Forward Gear** message appears in the display of the multimedia system: select the corresponding transmission position.

Vehicles with automatic transmission:

The vehicle exits of the parking space.

As soon as the **Parking Pilot Finished, Take Control of Vehicle** message appears in the display of

the multimedia system, you must accelerate, brake, steer and change gears yourself again.

Drive Away Assist

Drive Away Assist can reduce the severity of an impact when pulling away. If an obstacle is detected in the direction of travel, the vehicle's speed is briefly reduced to approx. 1 mph (2 km/h). If a critical situation is detected, a symbol appears on the camera image of the multimedia system.

⚠ WARNING Risk of accident caused by limited detection performance of Drive Away Assist

Drive Away Assist cannot always clearly identify objects and traffic situations.

In such cases, Drive Away Assist might:

- Warn you without reason and limit the vehicle speed.
- Not warn you or not limit the vehicle speed.

- ▶ Always pay careful attention to the traffic situation; do not rely on Drive Away Assist alone.
- ▶ Be prepared to brake or swerve if necessary.

Drive Away Assist is only an aid. It is not a substitute for your attention to the surroundings. The responsibility for safe maneuvering and parking remains with you. Make sure that no persons, animals or objects etc. are in the maneuvering range.

A risk of a collision may arise in the following situations, for example:

- If the driver mixes up the accelerator and brake pedals.
- If the wrong gear is selected.

The Drive Away Assist function is active under the following conditions:

- If Parking Assist PARKTRONIC is activated.
- Every time the gear is changed to **R** or **D** when the vehicle is at a standstill.

- If the detected obstacle is less than approx. 3.3 ft (1.0 m) away.
- If the maneuvering assistance function is activated in the multimedia system.

Drive Away Assist is unavailable on inclines and when driving with a trailer.

Cross Traffic Alert

 Also read the instructions on Blind Spot Assist (→ page 193).

Vehicles with Blind Spot Assist: Drivers can also be warned of any crossing traffic when reversing out of a parking space. If a critical situation is detected, a warning symbol appears on the camera image of the multimedia system. If the driver does not respond to the warning, the vehicle's brakes can be applied automatically. To do this, the function uses the radar sensors in the bumper. The area adjacent to the vehicle is continually monitored.

If the radar sensors are obstructed by vehicles or other objects, detection is not possible.





The Cross Traffic Alert function is active under the following conditions:

- If Blind Spot Assist is activated.
- If the vehicle is reversing at walking pace.
- If the maneuvering assistance function is activated in the multimedia system.

Cross Traffic Alert is unavailable on inclines and when driving with a trailer.

Activating/deactivating maneuvering assistance

Multimedia system:

 [Vehicle](#)  [System Settings](#)  [Parking Pilot](#)  [Maneuvering Assistance](#)

 Activate or deactivate the function.

ATTENTION ASSIST

Function of ATTENTION ASSIST

ATTENTION ASSIST assists you on long, monotonous journeys, e.g. on highways and trunk roads. If ATTENTION ASSIST detects indicators of fatigue or increasing lapses in concentration on the part of the driver, it suggests taking a break.

ATTENTION ASSIST is only an aid. It cannot always detect fatigue or lapses in concentration until too late. The system is not a substitute for a well-rested and attentive driver. On long journeys, take regular breaks in good time that allow for adequate recuperation.

You can choose between two settings.

- **Standard:** normal system sensitivity
- **Sensitive:** higher system sensitivity. The driver is warned earlier and the attention level detected by ATTENTION ASSIST is adapted accordingly.

If drowsiness or increasing lapses in concentration are detected, the **ATTENTION ASSIST: Take a Break!** warning appears in the Instrument Display. You can acknowledge the message and take a break where necessary. If you do not take a break and ATTENTION ASSIST continues to detect increasing lapses in concentration, you will be warned again after a minimum of 15 minutes.



You can have the following status information for ATTENTION ASSIST displayed in the assistance menu of the on-board computer:

- The length of the journey since the last break.
- The attention level determined by ATTENTION ASSIST.

if ATTENTION ASSIST is unable to calculate the attention level and cannot issue a warning, the **System Suspended** message appears.

If ATTENTION ASSIST is deactivated, the  symbol appears in the assistance graphic in the Instrument Display when the engine is running. ATTENTION ASSIST is activated automatically

when the engine is re-started. The last selected sensitivity level remains stored.

System limitations

ATTENTION ASSIST is active in the 37 mph (60 km/h) to 124 mph (200 km/h) speed range.

The functionality of ATTENTION ASSIST is restricted, and warnings may be delayed or not occur at all in the following situations:

- If you have been driving for less than 30 minutes.
- If the road condition is poor (uneven road surface or potholes).
- If there is a strong side wind.
- If you adopt a sporty driving style (high cornering speeds or high rates of acceleration).
- If the Steering Pilot function of Distance Pilot DISTRONIC is active.
- If the time has been set incorrectly.
- In active driving situations, if you change lanes and vary your speed frequently.

The ATTENTION ASSIST tiredness or alertness assessment is deleted and restarted when continuing the journey in the following situations:

- If you switch off the engine.
- If you unfasten your seat belt and open the driver's door (e.g. change drivers or take a break).

Activating/deactivating ATTENTION ASSIST

Multimedia system:

↳ Vehicle ▶ Assistance ▶ Attention Assist

Selection options

▶ Select **Standard**, **Sensitive** or **Off**.

Blind Spot Assist and Active Blind Spot Assist

Function of Blind Spot Assist and Active Blind Spot Assist

Blind Spot Assist uses two lateral, rear-facing radar sensors to monitor the area up to 130 ft (40 m) behind your vehicle and 10 ft (3 m) directly next to your vehicle.

If a vehicle is detected at speeds above approximately 8 mph (12 km/h) and this vehicle subsequently enters the monitoring range directly next to your vehicle, the warning lamp in the outside mirror lights up red.

If a vehicle is detected close to your vehicle in the lateral monitoring range and you switch on the turn signal indicator in the corresponding direction, a warning tone sounds once. The red warning lamp in the outside mirror flashes. If the turn signal indicator remains on, all other detected vehicles are indicated only by the flashing of the red warning lamp.

If you overtake a vehicle quickly, no warning is given.

⚠ WARNING Risk of accident despite Blind Spot Assist

Blind Spot Assist does not react to vehicles approaching and overtaking you at a greatly different speed.

As a result, Blind Spot Assist cannot warn drivers in this situation.

▶ Always pay careful attention to the traffic situation and maintain a safe distance at the side of the vehicle.

Blind Spot Assist and Active Blind Spot Assist are only aids. They may fail to detect some vehicles and are no substitute for attentive driving. Always ensure that there is sufficient distance to the side for other road users and obstacles.

System limitations

The detection capability of Blind Spot Assist can be restricted in the following situations:

- If the sensors are dirty or obscured.
- When there is poor visibility, e.g. due to fog, heavy rain, snow or spray.
- If narrow vehicles are within the monitoring range, e.g. bicycles.

Warnings may be issued in error when driving close to crash barriers or similar solid lane borders. Warnings may be interrupted when driving alongside long vehicles, for example, trucks, for a prolonged period.

Blind Spot Assist is not operational when reverse gear is engaged.

Brake application of Active Blind Spot Assist

If Active Blind Spot Assist detects a risk of a side impact in the monitoring range, a course-correcting brake application is carried out. This is designed to help you avoid a collision.

The course-correcting brake application is available in the speed range between approximately 20 mph (30 km/h) and 125 mph (200 km/h).

⚠️ WARNING Risk of accident despite brake application of Active Blind Spot Assist

A course-correcting brake application cannot always prevent a collision.

- ▶ Always steer, brake or accelerate yourself, especially if Active Blind Spot Assist warns you or makes a course-correcting brake application.
- ▶ Always maintain a safe distance at the sides.

⚠️ WARNING Risk of accident despite Active Blind Spot Assist

Blind Spot Assist does not react to the following:

- Overtaking vehicles closely on the side, placing them in the blind spot area
- Vehicles approaching and overtaking you at a very different speed

As a result, Active Blind Spot Assist may neither give warnings nor intervene in such situations.

- ▶ Always pay careful attention to the traffic situation and maintain a safe distance at the side of the vehicle.



If a course-correcting brake application occurs, the red warning lamp flashes in the outside mirror and a warning tone sounds. In addition, a display **1** indicating the danger of a side collision appears in the multifunction display.

In rare cases, the system may make an inappropriate brake application. This brake application may be interrupted at any time if you steer slightly in the opposite direction or accelerate.

System limitations

Either a course-correcting brake application appropriate to the driving situation, or none at all, may occur in the following situations:

- There are vehicles or obstacles, e.g. crash barriers, on both sides of your vehicle.
- A vehicle approaches too closely on the side.
- You have adopted a sporty driving style with high cornering speeds.
- You clearly brake or accelerate.
- A driving safety system intervenes, such as ESP® or Active Brake Assist.
- ESP® is deactivated.
- Tire pressure loss or a defective tire has been detected.
- When driving with a trailer, the electrical connection to the trailer hitch has been correctly established.

Activating/deactivating Blind Spot Assist or Active Blind Spot Assist

Multimedia system:

↳ Vehicle ▶ Assistance ▶ Blind Spot Assist

- ▶ Activate or deactivate the function.

Active Lane Keeping Assist

Function of Active Lane Keeping Assist

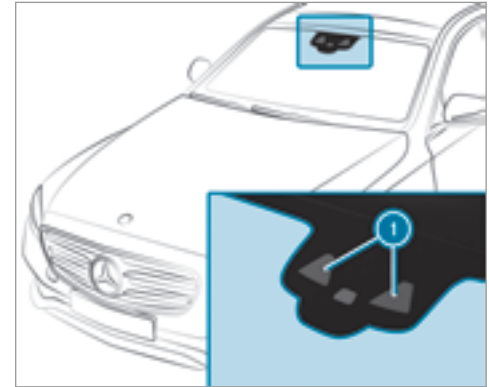

Active Lane Keeping Assist monitors the area in front of your vehicle by means of multifunction camera ①. It serves to protect you against unintentionally leaving your lane. You will be warned by means of a vibration in the steering wheel

and a course-correcting brake application guides you back into your lane.

You are warned by vibration pulses in the steering wheel in the following circumstances:

- Active Lane Keeping Assist detects lane markings.
- A front wheel passes over the lane markings.

You will also be guided back into your lane by means of a course-correcting brake application if the following conditions are met:

- Active Lane Keeping Assist detects lane markings on both sides.
- A front wheel drives over a solid lane marking.

Whether a warning is issued and when this occurs also depends on the selected sensitivity setting (standard or adaptive).

If you fail to adapt your driving style, Active Lane Keeping Assist can neither reduce the risk of an accident nor override the laws of physics. It cannot take into account road, weather or traffic conditions. Active Lane Keeping Assist is only an aid. You are responsible for the distance to the

vehicle in front, for vehicle speed, for braking in good time and for staying in lane.

Vehicles with Lane Tracking package: If the lane markings are solid lines and you do not react to the warning, a lane-correcting brake application can bring the vehicle back into the original lane.

Vehicles with Driving Assistance package or Driving Assistance Plus package: If you do not react to the warning, a lane-correcting brake application can bring the vehicle back into the original lane. In the case of a broken lane marking being detected, a brake application will only be made if a vehicle has been detected in the adjacent lane. Oncoming vehicles, overtaking vehicles and vehicles in adjacent lanes can be detected.

The brake application is available in the speed range between 40 mph (60 km/h) and 120 mph (200 km/h).



If a lane-correcting brake application occurs, display  appears in the multifunction display.

System limits

No lane-correcting brake application occurs in the following situations:

- You clearly and actively steer, brake or accelerate.
- You have switched on the turn signal indicator.
- A driving safety system intervenes, such as ESP®, Active Brake Assist or Active Blind Spot Assist.

- You have adopted a sporty driving style with high cornering speeds or high rates of acceleration.
- ESP® is deactivated.
- When driving with a trailer, the electrical connection to the trailer has been correctly established.
- If a loss of tire pressure or a defective tire has been detected and displayed.

The system may be impaired or may not function in the following situations:

- There is poor visibility, for example due to insufficient illumination of the road, highly variable shade conditions, or due to rain, snow, fog or heavy spray.
- There is glare, for example from the sun, reflections or oncoming traffic.
- There is dirt on the windshield in the vicinity of the multifunction camera or the camera is fogged up, damaged or obscured.
- No or several, unclear lane markings are present for one lane, for example in a construction area.

- The lane markings are worn, dark or covered.
- The distance to the vehicle in front is too small and the lane markings thus cannot be detected.
- The lane markings change quickly, e.g. lanes branch off, cross one another or merge.
- The road is very narrow and winding.

Vehicles with Driving Assistance package or Driving Assistance Plus package:

Active Lane Keeping Assist uses radar sensors to monitor several areas around the vehicle. If the radar sensors in the rear bumper are dirty or covered with snow, the system may be impaired or may not function. If an obstacle in the lane in which you are driving has been detected, no lane-correcting brake application occurs.

Switching on Active Lane Keeping Assist

⚠ WARNING Risk of accident despite Active Lane Keeping Assist warning

A lane-correcting brake application cannot always bring the vehicle back into the original lane.

▶ Always steer, brake or accelerate yourself, especially if Active Lane Keeping Assist warns you or makes a lane-correcting brake application.

⚠ WARNING Risk of accident despite intervention of Active Lane Keeping Assist

Active Lane Keeping Assist does not detect traffic conditions or road users. In very rare cases, the system may make an inappropriate brake application, e.g. after intentionally driving over a solid lane marking.

The brake application can be interrupted at any time if you steer slightly in the opposite direction.

▶ Always make sure that there is sufficient distance to the side for other traffic or obstacles.

⚠ WARNING Risk of accident despite Lane Keeping Assist

Lane Keeping Assist cannot always clearly detect lane markings.

In such cases, Lane Keeping Assist can:

- give an unnecessary warning
 - not give a warning
- ▶ Always pay particular attention to the traffic situation and keep within the lane, especially if Active Lane Keeping Assist alerts you.

Prerequisite

The driving speed is at least 40 mph (60 km/h).

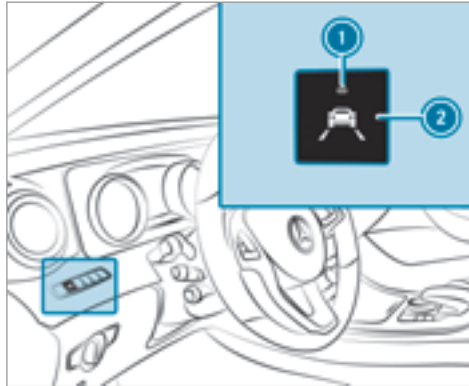

- ▶ Press button ②.
If indicator lamp ① lights up, Lane Keeping Assist is activated. When lane markings are detected, the lines in the assistance graphic are shown in white.

Sensitivity of Active Lane Keeping Assist

With the standard or adaptive setting, you can influence when the warning vibration of Lane Keeping Assist takes place.

In both the standard and adaptive settings, no warning vibration occurs in the following situations:

- You have switched on the turn signal indicator.
- A driving safety system intervenes, such as ABS, BAS or ESP®.

In the adaptive setting, there will also be no warning vibration in the following situations:

- The vehicle is accelerated or braked considerably.
- You steer actively, e.g. swerve to avoid an obstacle or change lane quickly.
- You cut the corner on a sharp bend.

Setting the sensitivity of Active Lane Keeping Assist

Multimedia system:

➔ [Vehicle](#) ▶ [Assistance](#) ▶ [Active Lane Keeping Assist](#)

Options

- ▶ Select [Adaptive](#) or [Standard](#).

Instrument Display overview

⚠ WARNING Risk of accident due to an instrument display malfunction

If the instrument display has failed or malfunctioned, you cannot recognize function restrictions applying to safety relevant systems.

The operating safety of your vehicle may be impaired.

- ▶ Drive on carefully.
- ▶ Have the vehicle checked immediately at a qualified specialist workshop.

If the operating safety of your vehicle is impaired, park the vehicle safely as soon as possible. Contact a qualified specialist workshop.

Instrument Display (standard)



- ① Speedometer
- ② Multifunction display
- ③ Tachometer
- ④ Coolant temperature display
- ⑤ Fuel level and fuel filler flap location indicator

The segments in speedometer ① indicate the system status for the following:

- Cruise control (→ page 163)
- Distance Pilot DISTRONIC (→ page 165)

⚠ NOTE Engine damage due to excessively high engine speeds

The engine will be damaged if you drive with the engine in the overrevving range.

- ▶ Do not drive with the engine in the overrevving range.

The fuel supply is interrupted to protect the engine when the red band in tachometer ③ (overrevving range) is reached.

During normal operating conditions, coolant temperature display ④ may rise to 248 °F (120 °C).

⚠ WARNING Danger of burns when opening the hood





If you open the hood when the engine has overheated or during a fire in the engine compartment, you could come into contact with hot gases or other escaping operating fluids.

- ▶ Before opening the hood, allow the engine to cool down.

▶ In the event of a fire in the engine compartment, keep the hood closed and call the fire service.

Overview of the buttons on the steering wheel







- ① Button group:
-  Main menu and back button (on-board computer)
 -  Switches sound off/on
 -  Increases the volume
 -  Decreases the volume

② Touch Control (on-board computer)

③ Touch Control (multimedia system)

④ Button group:

-  Main menu and back button (multimedia system)
-  Voice Control System
-  Makes/accepts a call
-  Rejects/ends a call

Operating the on-board computer

⚠ WARNING Risk of distraction from information systems and communications equipment

If you operate information and communications equipment integrated in the vehicle when driving, you will be distracted from the traffic situation. This could also cause you to lose control of the vehicle.

- ▶ Only operate this equipment when the traffic situation permits.
- ▶ If you cannot be sure of this, stop the vehicle whilst paying attention to road

and traffic conditions and operate the equipment with the vehicle stationary.

You must observe the legal requirements for the country in which you are currently driving when operating the on-board computer.

ⓘ The on-board computer displays appear in the multifunction display (→ page 201).



The on-board computer is operated using Touch Control ② and back button ① on the left-hand side of the steering wheel.

The following menus are available:

- [Service](#)

- DriveAssist
- Trip
- Navigation
- Radio
- Media
- Phone
- HUD

The menus can be called up from the menu bar in the multifunction display.



- ▶ **To call up the menu bar:** press the back button on the left.

- ▶ **To scroll in the menu bar:** swipe to the left or right on the left-hand Touch Control.
- ▶ **To call up the menu or confirm the selection:** press the left-hand Touch Control.
- ▶ **To scroll through displays or lists in the menu:** swipe upwards or downwards on the left-hand Touch Control.
- ▶ **To call up the submenu or confirm the selection:** press the left-hand Touch Control.
- ▶ **To exit the submenu:** press the back button on the left.

If you are browsing a submenu and you press and hold the back button on the left, the menu bar appears.



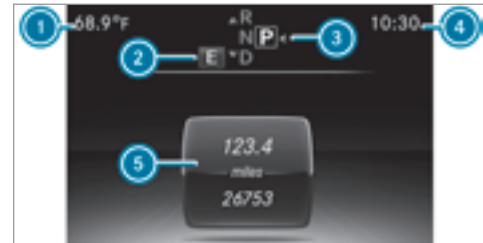

Displays in the multifunction display



- ① Outside temperature
- ② Drive program
- ③ Transmission position (→ page 141)
- ④ Time
- ⑤ Display section

Further displays in the multifunction display:

- ↑ Gearshift recommendation (→ page 143)
- Parking Pilot activated
- Parking Assist PARKTRONIC deactivated
- Cruise control (→ page 163)

-  Distance Pilot DISTRONIC (→ page 171)
(→ page 165)
-  Steering Pilot (→ page 171)
-  ECO start/stop function
-  HOLD function (→ page 173)
-  Adaptive Highbeam Assist (→ page 116)

Adjusting the instrument lighting

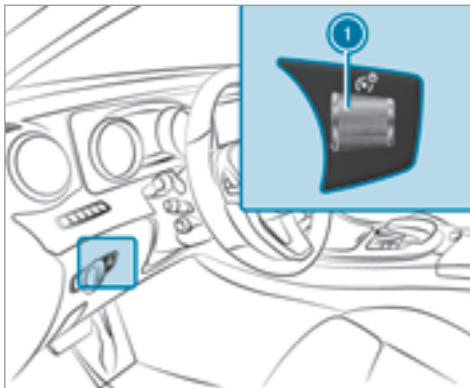

- ▶ Turn brightness control ① up or down. The lighting of the Instrument Display and in the controls in the vehicle interior is adjusted.

Menus and submenus

Functions in the Service menu of the on-board computer

On-board computer:

↳ Service

- ▶ **To select the function:** swipe upwards or downwards on the left-hand side of Touch Control.
- ▶ Press the left-hand Touch Control.

Functions in the [Service](#) menu:

- Message memory (→ page 326)
- [Tire Pressure](#):
 - Checking the tire pressure with the tire pressure monitoring system (→ page 290)
 - Restarting the tire pressure monitoring system (→ page 291)
- [ASSYST PLUS](#): call up the service due date (→ page 250)

Calling up the Assistance graphic display

On-board computer:

→ DriveAssist



The following displays are available from the Assistance graphic menu:

- Assistance graphic
- Attention level (→ page 191)

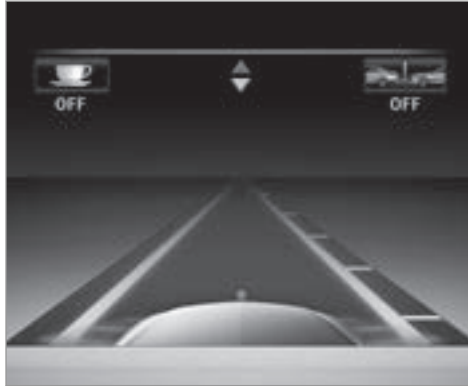
▶ **To switch between the displays:** swipe upwards or downwards on the left-hand side of Touch Control.



Status displays in the Assistance graphic:

-  OFF: ATTENTION ASSIST deactivated
-  OFF: Active Brake Assist deactivated
- Light lane markings: Active Lane Keeping Assist activated
- Green lane markings: Active Lane Keeping Assist activated

- Gray radar waves next to vehicle: Blind Spot Assist activated
- Green radar waves next to vehicle: Blind Spot Assist activated
- Display of Distance Pilot DISTRONIC (→ page 165)

Calling up displays in the Trip menu

On-board computer:

→ Trip

▶ **To select a display:** swipe up or down on the left-hand Touch Control.

Displays in the Trip menu:

- Standard display
- Range and current fuel consumption
A recuperation display is also available for certain engines. If there is only a small amount of fuel left in the fuel tank, the display shows a vehicle being refueled instead of the range.
- ECO display (→ page 139)
- Trip computer [From Start](#) and [From Reset](#)

- Digital speedometer



Example: standard display

- ① Trip distance
- ② Total distance



Example: trip computer

- ① Total distance
- ② Driving time
- ③ Average speed
- ④ Average fuel consumption

Resetting values in the Trip menu of the on-board computer

On-board computer:



You can reset the values of the following functions:

- Trip distance

- Trip computer "From start" and "From reset"
- ECO display

- ▶ **To select the function to be reset:** swipe upwards or downwards on the left-hand Touch Control.
- ▶ Press the left-hand Touch Control.
- ▶ Select **Yes**.
- ▶ Press the left-hand Touch Control.

If you press and hold the left-hand side of Touch Control, the function will be reset immediately.

Calling up navigation instructions in the on-board computer

On-board computer:

↳ Navigation



Example: no change of direction announced

- ① Distance to the next destination
- ② Estimated arrival time
- ③ Distance to the next change of direction
- ④ Current road

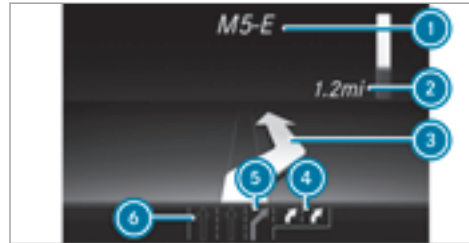

Example: change of direction announced

- ① Road to which the change of direction leads
- ② Distance to the change of direction
- ③ Change-of-direction symbol
- ④ Recommended lane and new lane during a change of direction (white)
- ⑤ Possible lane
- ⑥ Lane not recommended (dark gray)

Further possible displays in the [Navigation](#) menu:

- [Direction of Travel](#): display of direction of travel and road currently being traveled on.

- [New Route...](#) or [Calculating Route...](#): a new route is calculated.
 - [Road Not Mapped](#): the road is unknown, e.g. newly built roads.
 - [No Route](#): no route could be calculated to the selected destination.
 - [Off Map](#): the map for the current location is not available.
 - [Area of Destination Reached](#): you have reached the area of destination.
 -  : you have reached the destination or an intermediate destination.
- ▶ **To exit the menu:** press the back button on the left.

Selecting radio stations using the on-board computer

On-board computer:

→ Radio



- ① Frequency range
- ② Station
- ③ Name of track
- ④ Name of artist

When you select a station in the presets, the preset appears next to the station name. When you select a saved station in the frequency range, an asterisk appears next to the station name.

- ▶ **To select a radio station:** swipe upwards or downwards on the left-hand Touch Control.

Selecting the frequency range or station preset

- ▶ Press the left-hand Touch Control.
- ▶ **To select the frequency range/station preset:** swipe upwards or downwards on the left-hand Touch Control.
- ▶ Press the left-hand Touch Control.

Playing back media using the on-board computer

On-board computer:

→ Media

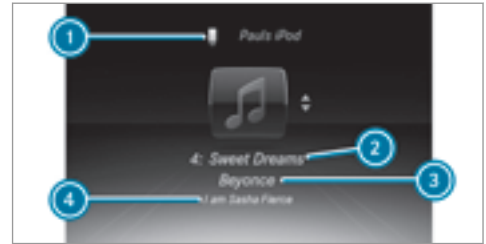

- ① Media source
- ② Current track and track number
- ③ Name of artist
- ④ Name of album

The folder name also appears in the display.

- ▶ **To change tracks in the active media source:** swipe upwards or downwards on the left-hand side of Touch Control.

Changing the media source

- ▶ Press the left-hand Touch Control.
- ▶ **To select a media source:** swipe upwards or downwards on the left-hand side of Touch Control.
- ▶ Press the left-hand Touch Control.

Dialing telephone numbers using the on-board computer

Requirements

- Mobile phone connected to the multimedia system

On-board computer:

➤ Phone

⚠ WARNING Risk of distraction from information systems and communications equipment

If you operate information and communications equipment integrated in the vehicle when driving, you will be distracted from the

traffic situation. This could also cause you to lose control of the vehicle.

- ▶ Only operate this equipment when the traffic situation permits.
- ▶ If you cannot be sure of this, stop the vehicle whilst paying attention to road and traffic conditions and operate the equipment with the vehicle stationary.

When telephoning, you must observe the legal requirements for the country in which you are currently driving.

Vehicles with the Audio 20 multimedia system: The most recently dialed telephone numbers are displayed in the **Phone** menu.

- ▶ **To select the telephone number:** swipe upwards or downwards on the left-hand Touch Control.
- ▶ Press the left-hand Touch Control.
If there is only one telephone number saved to an entry: the telephone number is selected.
- ▶ **If there are multiple telephone numbers saved to an entry:** swipe upwards or down-

wards on the left-hand Touch Control to select the desired telephone number.



- ▶ Press the left-hand Touch Control.
The telephone number is dialed.



The following displays may appear instead of the telephone numbers dialed:

- **Please Wait...:** the application is starting. When a Bluetooth® connection to the mobile phone is not established, the menu for authorizing and connecting a mobile phone is displayed in the multimedia system .
- **Updating data...:** the call list is being updated.
- **Importing Contacts...:** the contacts from the mobile phone or from a storage medium are imported.

Accepting/rejecting a call

When you receive a call, a message appears in the Head-up Display **Incoming Call**.

- ▶ Swipe upwards or downwards on the left-hand Touch Control and select  (Accept) or  (Reject).
- ▶ Press the left-hand Touch Control.

The call may be accepted/rejected using the  or  buttons on the steering wheel.

Adjusting the Head-up Display settings in the on-board computer

On-board computer:



The following Head-up Display settings can be adjusted:

- Position
- Brightness
- Display Content

- ▶ **To select the setting:** swipe upwards or downwards on the left-hand Touch Control.
- ▶ Press the left-hand Touch Control.
- ▶ **To adjust the value:** swipe upwards or downwards on the left-hand Touch Control.
- ▶ Press the left-hand Touch Control.



- ① Currently selected setting
- ② Digital speedometer
- ③ Traffic Sign Assist
- ④ Navigation displays

Head-up Display

Function of the Head-up Display

The Head-up Display projects information from the navigation system and the driver assistance system above the cockpit into the driver's field of vision.

Display elements

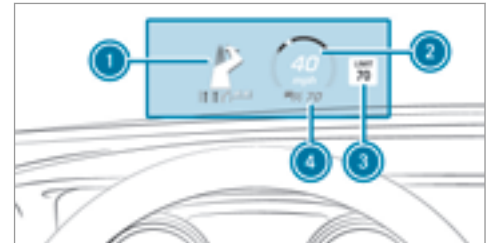

- ① Navigation messages
- ② Current speed
- ③ Detected instructions and traffic signs
- ④ Set speed in the driver assistance system (e.g. cruise control)

When you receive a call, a message appears in the Head-up Display  Incoming Call.

System limitations

The visibility is influenced by the following conditions:

- Seat position
- The positioning of the display image
- Light conditions
- Wet roads
- Objects on the display cover
- Polarization in sunglasses

Switching the Head-up Display on/off

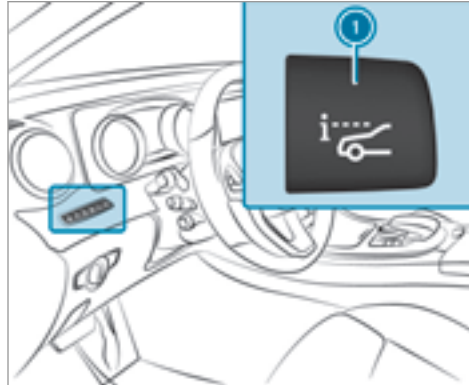



▶ Press button .

Overview and operation

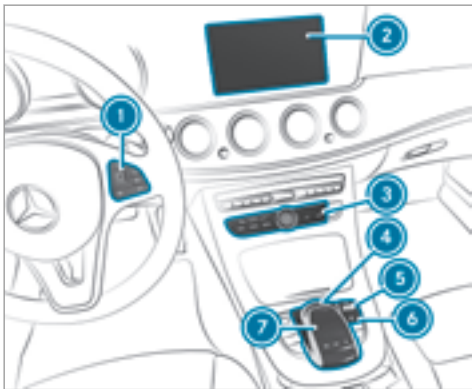
Overview of the multimedia system



- ① Touch Control
- ② Display
- ③ **NAVI**, **RADIO**, **MEDIA**, **TEL**,  buttons, calls up main functions
- ④ Controller

- ⑤ Control knob, adjusts the volume and switches the sound on or off
- ⑥  button, switches the multimedia system on or off
- ⑦ Touchpad

The three central controls are Touch Control ①, controller ④ and touchpad ⑦.

Notes on the display

! NOTE Scratching of the display

The display has a highly sensitive, high-gloss surface. There is a risk of it becoming scratched.

Avoid touching the display.

Observe the notes on cleaning.

Observe the notes on caring for the interior (→ page 262).

Automatic temperature-controlled switch-off feature: if the temperature is too high, the brightness is initially reduced automatically. The

display may then switch off completely for a while.

- ① If you are wearing polarized sunglasses, it may be difficult to read the display.

Central controls overview



- ① Touch Control
- ② Controller
- ③ Touchpad

The list shows operating options and provides operating examples.

Controller

- **slide** ←○→ left or right
 - selects a radio station
 - calls up a list
- **slide** ↑○↓ up or down
 - highlights a preset in the station
 - selects a system language
- **slide** ↘○↙ diagonally
 - moves the crosshair across the map
- **turn** {○}

 - sound: sets the treble, mid-range and bass
 - selects a favorite
 - connects a mobile phone: selects a mobile phone from the list of detected mobile phones

- **press** ○

 - stores radio stations
 - confirms a selection or entry

Touch Control and touchpad (single-finger swipe)

- **swipe** left or right
 - selects a radio station
 - calls up a list
- **swipe** up or down
 - highlights a preset in the station
 - selects a system language
- **swipe** diagonally
 - moves the crosshair across the map
- **press**
 - stores radio stations
 - confirms a selection or entry

Touchpad (two-finger swipe)

- **turn** right or left using two fingers
 - tone settings: adjusts the treble, mid-range and bass
- move two fingers **apart** or **together**
 - changes the map scale (zoom in or out)

Touch Control

Operating Touch Control

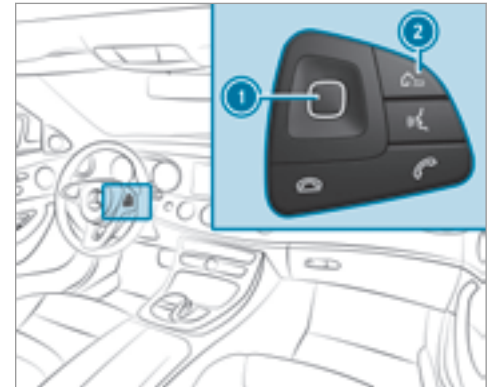

- ▶ **To select a menu item:** swipe up, down, left or right on Touch Control ①.
- ▶ Press Touch Control ①.
- ▶ **To open a list:** press Touch Control ①.
- ▶ **To close a list:** press the ② button.

- ▶ **To move the digital map:** swipe in any direction.

Setting the sensitivity

Multimedia system

↳ [Vehicle](#) ▶ [System Settings](#)

- ▶ Select [Touch Control Sensitivity](#).
- ▶ Set the sensitivity.

Operating the controller

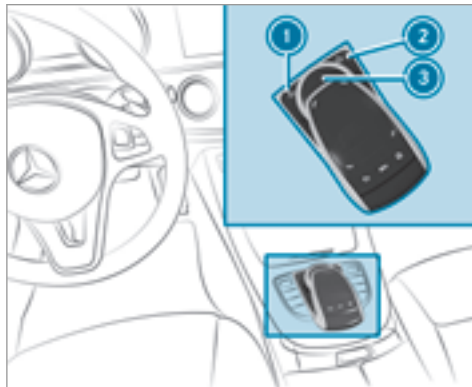

- ① button, to return to the previous display (press briefly), to call up the basic menu (press and hold)
- ② Calls up the touchpad button, calls up favorites
- ③ Controller

Controller operating options:

- ▶ Turn left or right.
- ▶ Slide left or right.
- ▶ Slide up or down.
- ▶ Slide diagonally.
- ▶ Press briefly or press and hold.

Using the controller, you can:

- navigate through menus and lists
- save stations or contacts
- create favorites
- adjust tone settings
- enter characters

Touchpad

Switching the touchpad on/off

Multimedia system:

↳ [Vehicle](#) ▶ [System Settings](#)

- ▶ **Touchpad without handwriting recognition:** switch [Activate Touchpad](#) on or off .



- ▶ **Touchpad with handwriting recognition:** select [Touchpad](#).
- ▶ Switch [Activate Touchpad](#) on or off .

Operating the touchpad

Prerequisite

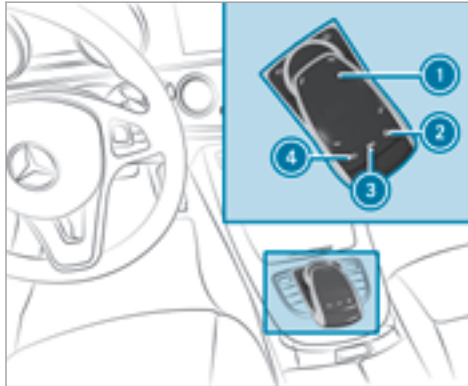
The touchpad is switched on (→ page 212).



- ① Touchpad
- ②  button, calls up favorites
- ③  button, calls up the audio menu
- ④  button, returns to the previous display (press briefly), calls up the basic menu (press and hold)

You can navigate in menus and lists via touch-sensitive surface ① by using a **single-finger swipe**.

- ▶ **To select the menu item:** swipe up, down, left or right.
- ▶ Press the touchpad.
- ▶ **To close and open lists:** swipe left or right.
- ▶ **To move the digital map:** swipe in any direction.

Use the following functions with a **two-finger swipe**:

- ▶ **To show or hide the audio menu:** swipe up or down using two fingers.
- ▶ **To zoom in and out of the map:** move two fingers apart or together.
- ▶ **To increase or reduce the vehicle settings and sound settings:** turn two fingers clockwise or counter-clockwise.

Handwriting recognition: switching the read-aloud function on/off

Requirement:

The touchpad is equipped with handwriting recognition.

Multimedia system:

➤ Vehicle ➤ System Settings ➤ Touchpad

- Switch **Read Out Handwriting Recognition** on or off .

Handwriting recognition: selecting an input language

- Select .
- Select an input language.

Selecting a station and track using the touchpad

- Swipe upwards using two fingers on the touchpad.
A control menu shows the current audio source.
- Swipe left or right using one finger.
Radio: the previous or next station is set.

Media source: the previous or next track is selected.

- **To hide the control menu:** swipe down on the touchpad using two fingers.

Main functions

Calling up the main functions

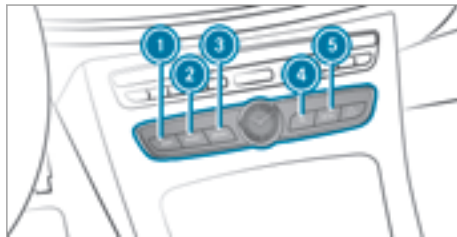

- ① **NAVI** button: switches navigation on
- ② **RADIO** button: switches the radio on
- ③ **MEDIA** button: switches the audio source on

- ④ **TEL** button: switches telephone mode on

- ⑤  button: calls up vehicle functions

Alternatively:

- When the basic menu of a main function is shown, press the  button.
- **To select a main function:** turn and press the controller.

or

- Swipe left or right on the touchpad and then press the touchpad.

Calling up menus on the multimedia system

Calling up a menu

- Call up a main function (→ page 214).
- **To show the menu:** swipe up or down on the touchpad.

or

- Slide the controller up or down.
The marker is shown either in the main function line or menu bar.

▶ **To select a menu item:** swipe left or right on the touchpad and then press it.

or

▶ Slide the controller to the left or right and press it.
Main function line (top) is selected: another main function is called up.
Menu bar (bottom) is selected: a menu appears.

Calling up an operating mode for a main function

▶ Call up a main function (→ page 214).
▶ Select the main function in the main function line again.
▶ Swipe left or right on the touchpad and press it.

or

▶ Slide the controller to the left or right and press it.
Depending on the main function, a range of operating modes are available.

For media selection, the following media sources can be selected, for example:

- Memory Card
- Media Interface 1
- Media Interface 2
- Bluetooth Audio
- Info on Media

▶ Alternatively for media selection: select **Devices** in the lower menu bar.
▶ Swipe up or down on the touchpad and press it.

or

▶ Slide the controller up or down and press it.
The media source is selected. Playback starts.

Favorites

Overview of favorites

Favorites offer you quick access to frequently used applications. It is possible to create 20 favorites in total.

The following functions are available:

- add **pre-defined favorites** from the following categories:
 - Navigation
 - Entertainment
 - Tel/
 - Vehicle
 - Climate Control
- add **your own favorites**
- rename a favorite
- move a favorite
- delete a favorite

Calling up favorites

▶ Press the  button.
The favorites are displayed.
▶ Swipe left or right on the touchpad and press it.

or

▶ Turn and press the controller.

Leaving the Favorites menu

- ▶ Press the  button again.

Adding a favorite

Adding a pre-defined favorite

- ▶ Press the  button.
The favorites are displayed.
- ▶ Swipe down on the touchpad or slide the controller down.
The Favorites menu appears.
- ▶ Select **Reassign**.
The categories are displayed.
- ▶ Select a category.
The favorites are displayed.
- ▶ Select a favorite.
- ▶ Add a favorite at the desired position.
If a favorite has already been added at this position, it will be overwritten.

Example: adding your own favorite

- ▶ Select **Vehicle**.
- ▶ Select **Full Screen: 'Consumption'**.

- ▶ Press and hold the  button until the favorites are displayed.
- ▶ Add a favorite at the desired position.

Renaming a favorite

- ▶ Press the  button.
The favorites are displayed.
- ▶ Select a favorite.
- ▶ Swipe down on the touchpad or slide the controller down.
The Favorites menu appears.
- ▶ Select **Rename**.
- ▶ Enter characters.
- ▶ Confirm the entry.

Moving a favorite

- ▶ Press the  button.
The favorites are displayed.
- ▶ Select a favorite.
- ▶ Swipe down on the touchpad or slide the controller down.
The Favorites menu appears.
- ▶ Select **Move**.

- ▶ **To create a favorite at a desired position:**
swipe left or right on the touchpad and press it.

or

- ▶ Turn and press the controller.
If a favorite has already been added at this position, it will be overwritten.

Deleting a favorite

- ▶ Press the  button.
The favorites are displayed.
- ▶ Select a favorite.
- ▶ Navigate downwards once.
The Favorites menu appears.
- ▶ Select **Delete**.
- ▶ Select **Yes**.

Switching the sound on/off

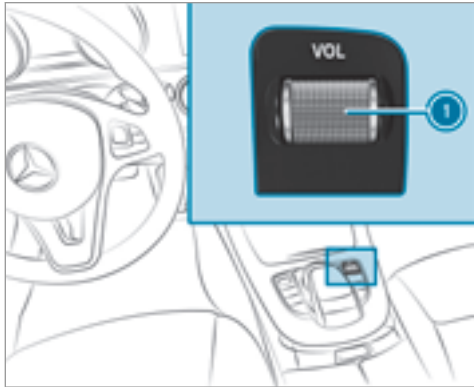

- ▶ **To switch off:** press control knob ①. The  symbol appears in the status line. You will also hear traffic announcements and navigation announcements even when the sound is muted.
- ▶ **To switch on:** change the media source or adjust the volume.

Entering characters

Using the character input function

On Touch Control

- ▶ Select a character in the character bar. Depending on the target entry, either a full set of characters is available or, alternatively, only those characters that are available on the basis of the characters that have already been entered.

On the controller

- ▶ Select a character in the character bar. Depending on the target entry, either a full set of characters is available or, alternatively, only those characters that are available on the basis of the characters that have already been entered.

On the touchpad

- ▶ Write the characters on the touch-sensitive surface of the touchpad. Handwriting recognition supports you by means of character suggestions and a read-aloud function.

Switching between central operating controls

- ▶ **To activate Touch Control:** press Touch Control.
- ▶ **To activate the controller:** press the controller.
- ▶ **To activate the touchpad:** press the touchpad.

Characters can be entered using the following methods:

- using a keyword search for a track or artist
- connecting the mobile phone to the multimedia system by entering the passkey
- entering a phone number
- entering a web address

Entering characters using the controller

Entering characters

- ▶ Turn , slide  or  and press the controller.

Use the following editing functions:

-  or 

Switches to upper-case or lower-case letters



Switches to special characters and symbols



Changes the language



Selects the input line



Moves the cursor within the input line



Deletes a character or an entry



Cancels character entry

Deleting a character or an entry

▶ **To delete a character:** when  is highlighted, press the controller.

▶ **To delete an entry:** when  is highlighted, press and hold the controller until the entry has been deleted.

Confirms an entry

▶ Select .

Entering characters on the touchpad





Enter characters

▶ Use one finger to write characters on the surface. The character is entered in the input line. If different interpretations are possible, character suggestions are displayed.

Selecting a character suggestion

- ▶ Turn the controller.
- ▶ Press the touchpad.
- ▶ Resume character input.

The following editing functions can be used:

-  Changes the language
-  Selects the input line
-  Moves the cursor within the input line
- 

Cancels character entry.

Selecting the input line

- ▶ Select .
- ▶ Swipe up or down.

Moving the cursor within the input line

- ▶ Select .
- ▶ Swipe to the left or right.

Deleting characters

- ▶ When an input line is selected, swipe left.

Confirms an entry

- ▶ Press the touchpad.

System settings

Display

Configuring display settings

Multimedia system:

↳ Vehicle ▶▶ System Settings ▶▶ Display

Display design

- ▶ Select [Day Mode](#), [Night Mode](#) or [Automatic](#).

Display brightness

- ▶ Select [Brightness](#).
- ▶ Select a brightness value.

Switching off the display

Multimedia system:

↳ [Vehicle](#)

- ▶ Select [Display Off](#).
The display is switched off.

Time and date

Setting the time and date automatically

This function is only available in vehicles with GPS reception.

Multimedia system:

↳ [Vehicle](#) ▶ [Time](#)

- ▶ Activate or deactivate [Automatic Time Settings](#).

Setting the time zone

Multimedia system:

↳ [Vehicle](#) ▶ [Time](#) ▶ [Time Zone:](#)

A list of countries is displayed.

- ▶ Select a country •.
Depending on the country, time zones are displayed.
- ▶ Set the time zone.
The time zone set is displayed after [Time Zone:](#).

Setting Daylight Saving Time (Summer)

The [Daylight Saving Time](#) and [Daylight Saving Time Setting](#) options cannot be selected in all countries.

Multimedia system:

↳ [Vehicle](#) ▶ [Time](#)

Vehicles with GPS

- ▶ Select [Daylight Saving Time](#).
- ▶ Select [On](#), [Off](#) or [Automatic](#).
 - [Automatic](#): the automatic changeover to summer time is not available for all time zones.
 - [Off](#): standard time is set.

Vehicles without GPS

- ▶ Activate or deactivate [Current Time: Daylight Saving Time](#).
- ▶ Summer time changeover: select [Daylight Saving Time Setting](#).
- ▶ Select [Automatic](#), [Daylight Saving Time](#) or [Standard Time](#).
The current setting is marked with •.
The local time is set one hour forward or back.
 - [Automatic](#): the automatic changeover to Daylight Saving Time is not available for all time zones.

Setting the time and date format

Multimedia system:

↳ [Vehicle](#) ▶ [Time](#) ▶ [Format](#)

- ▶ Set the date and time format •.

Setting the time and date manually

Multimedia system:

↳ Vehicle ▶ Time

Vehicles with GPS

It may be useful to set the time manually in the following situations:

- a country is not contained in the list of time zones
- a time differing from the local time is set

▶ Select [Set Time Manually](#).

▶ Set the hours.

▶ Navigate to the right to set the minutes.

▶ Set the minutes.

The [Automatic Time Settings](#) function is deactivated .

i The time can be set back by 12 hours and forward by 14 hours.

Vehicles without GPS

▶ Select [Set Time](#) or [Set Date](#).

▶ Set the time or date.

The various time and date settings must be set correctly to enable a reliable Internet connection to be established.

Bluetooth®

Bluetooth® settings

Bluetooth® technology is a standard for short-range wireless data transfer up to approximately 32.8 ft (10 m). You can use Bluetooth® to connect your mobile phone to the multimedia system and use the following functions, for example:

- Hands-free system with access to the following options:
 - Phone book (→ page 227)
 - Call lists (→ page 229)
 - Messages (→ page 230)
- Internet connection
- Listening to music via Bluetooth® audio (→ page 241)
- Transferring business cards (vCards) into the vehicle

Bluetooth® is a registered trademark of Bluetooth Special Interest Group (SIG) Inc.

i Internet connection via Bluetooth® is not available in all countries.

Activating/deactivating Bluetooth®

Multimedia system:

↳ Vehicle ▶ System Settings ▶ Activate Bluetooth

▶ Activate or deactivate Bluetooth®.

Activating/deactivating automatic volume adjustment

Multimedia system:

↳ Vehicle ▶ System Settings ▶ Automatic Volume Adjustment

Automatic volume adjustment compensates for differing volumes when changing between audio sources.

▶ Switch the function on or off .

System language

Notes on the system language

This function allows you to determine the language for the menu displays and the navigation announcements. The selected language affects the characters available for entry. The navigation announcements are not available in all languages. If a language is not available, the navigation announcements will be in English.

Setting the system language

Multimedia system:

↳ Vehicle ▶ System Settings ▶ Language

▶ Set the language.

Setting the distance unit and temperature unit

Multimedia system:

↳ Vehicle ▶ System Settings ▶ Units

Distance

▶ Select **Units**.

- ▶ Select **km** or **mi**.
- ▶ Switch **Additional Speedometer** on to display in the instrument cluster's multifunction display.

Temperature

- ▶ Select **Temperature Display**.
- ▶ Select **Outside** or **Cooling**.

Data import and export

Data import/export function

The following functions are possible:

- transferring data from one system or vehicle to another system or vehicle.
- creating a backup copy of your personal data and loading it again.
- protecting your personal data against unwanted export with PIN protection.

You can either use an SD card or a USB storage device as temporary storage.

- ⓘ Please note that the NTFS file system is not supported. The FAT32 file system is recommended.

Importing/exporting data

NOTE Data loss

- ▶ Do not remove the data storage medium when data is being exported.

Mercedes-Benz is not liable for any loss of data.

Requirements

- The vehicle is stationary.
- The ignition is switched on or the vehicle has been started.
- The SD card is inserted (→ page 238).

Multimedia system

↳ Vehicle ▶ System Settings ▶ Data Import/Export

▶ Select **Import Data** or **Export Data**.

Importing

- ▶ Select a data storage medium. A prompt appears asking whether you really wish to overwrite the current data.
- The existing data in the multimedia system is overwritten, e.g. address data. A message appears.
- The multimedia system is restarted once the data has been imported.

Exporting

If PIN protection is activated, your PIN is requested.

- ▶ Enter your four-digit PIN.
- ▶ Select a data storage medium. The data is exported. The data export may take several minutes.

Activating/deactivating PIN protection for data export

Multimedia system:

↳ Vehicle ▶ System Settings ▶ Data Import/Export

- ▶ **To activate:** activate [Activate PIN Protection](#) .
- ▶ Enter your four-digit PIN.
- ▶ Enter your four-digit PIN again. PIN protection is activated when both PINs match.
- ▶ **To deactivate:** deactivate [Activate PIN Protection](#) .
- ▶ Enter your four-digit PIN.
- ▶ **i** If you have forgotten your PIN, an authorized Mercedes-Benz Center can deactivate your PIN protection for you. Alternatively: you can deactivate PIN protection by resetting your personal data (→ page 222).

Reset function

Multimedia system:

↳ Vehicle ▶ System Settings ▶ Reset

The multimedia system is reset to the factory settings.

Personal data is deleted, for example:

- Station presets
- Connected mobile phones
- ▶ Select [Yes](#). A prompt appears asking whether you wish to reset. [No](#) selected: the process is canceled.
- ▶ Select [Yes](#). The multimedia system is reset to factory settings and restarted.

Garmin® MAP PILOT navigation module

Overview of Garmin® MAP PILOT navigation module

⚠ DANGER Risk of fatal injury caused by swallowing SD memory cards

SD memory cards are small parts.

They can be swallowed and cause choking.

- ▶ Keep SD memory cards out of the reach of children.
- ▶ Seek medical attention immediately if a SD memory card has been swallowed.

⚠ WARNING Risk of distraction from information systems and communications equipment

If you operate information and communications equipment integrated in the vehicle when driving, you will be distracted from the traffic situation. This could also cause you to lose control of the vehicle.

- ▶ Only operate this equipment when the traffic situation permits.
- ▶ If you cannot be sure of this, stop the vehicle whilst paying attention to road and traffic conditions and operate the equipment with the vehicle stationary.

During operation of the Garmin® MAP PILOT, always observe the following:

- The legal requirements for the country in which you are currently driving.
- Road and traffic rules and regulations always have priority over Garmin® MAP PILOT driving recommendations.

Observe the following notes on the operating instructions and updates:

- The Garmin® MAP PILOT operating instructions are stored on the SD memory card as a PDF file.
- The SD card box contains a printed quick guide.

- You can obtain digital map and software updates from an authorized Mercedes-Benz Center.

For some countries, digital map and software updates are available in the form of a download or an SD memory card.

For downloads, visit <http://shop.mercedes-benz.com> and follow the information in the Garmin® MAP PILOT section.

Further information (see the manufacturer's operating instructions).

Switching the Garmin® MAP PILOT navigation module on

! **NOTE** Damage caused by high temperatures

High temperatures can damage the SD memory card.

- ▶ Remove the SD memory card after use and take it out of the vehicle.

Multimedia system:



Alternatively: press the **NAVI** button.

Inserting the SD memory card (→ page 238).

Telephone

Telephony

Telephone menu overview



- ① Mobile phone network provider
- ② Signal strength of the mobile phone network
- ③ (telephone ready) or (call active)

- ④ Bluetooth® device name of the currently connected mobile phone
- ⑤ Telephone menu character bar
- ⑥ Enters characters using the touchpad
- ⑦ Displays the phone book

Symbols ① to ④ are not shown until after a mobile phone has been connected to the multimedia system. The symbols depend on your mobile phone and your mobile phone network provider.

The Bluetooth® interface is available to you for telephony. The mobile phone is connected directly via the multimedia system.

If the mobile phone connected supports the MAP Bluetooth® profile (**M**essage **A**ccess **P**rofile), the menu item is available.

Notes on telephony

⚠ WARNING Risk of distraction from operating integrated communication equipment while the vehicle is in motion

If you operate communication equipment integrated in the vehicle when driving, you will be distracted from the traffic situation. This could also cause you to lose control of the vehicle.

- ▶ Only operate this equipment when the traffic situation permits.
- ▶ If you cannot be sure of this, stop the vehicle whilst paying attention to road and traffic conditions and operate the equipment with the vehicle stationary.

⚠ WARNING Risk of distraction from operating mobile communication equipment while the vehicle is in motion

If you operate mobile communication equipment when driving, you will be distracted from the traffic situation. This could also cause you to lose control of the vehicle.

Only operate this equipment when the vehicle is stationary.

You must observe the legal requirements for the country in which you are currently driving when operating mobile communication equipment in the vehicle.

Telephony is possible via:

- The Bluetooth® interface

Bluetooth® profile overview

Bluetooth® profile of the mobile phone	Function
PBAP (Phone Book Access Profile)	Contacts are automatically displayed in the multimedia system
MAP (Message Access Profile)	Message functions can be used

Further information can be obtained from an authorized Mercedes-Benz Center or at: <http://www.mercedes-benz.com/connect>.

HD Voice®

- To improve voice quality, the multimedia system supports telephone calls in HD Voice®.
- In order to use this function, the mobile phones and the mobile phone network provider of the person you are calling must support HD Voice®.

Depending on the quality of the connection, the voice quality may fluctuate.

The following situations can lead to the call being disconnected while the vehicle is in motion:

- There is insufficient network coverage in the area
- You move from one GSM or UMTS transmitter/receiver area (cell) into another and no communication channels are free
- The SIM card used is not compatible with the network available
- A mobile phone with "Twincard" is logged into the network with the second SIM card at the same time

Disconnecting a mobile phone (de-authorizing)

Multimedia system:

↳ Tel/🌐 ▶▶ Phone ▶▶ Connect Device

- ▶ Highlight the mobile phone in the device list.
- ▶ Select .
- ▶ Select **Deauthorize**.
- ▶ Select **Yes**.

Switching mobile phones

Prerequisite

The mobile phones are authorized .

Multimedia system:

↳ Tel/🌐 ▶▶ Phone ▶▶ Connect Device

- ▶ Select the mobile phone from the device list.
- ⓘ Only one mobile phone can be connected at any one time. The mobile phone that is currently connected is indicated with a point ●.

Setting the reception and transmission volume

Requirement

A mobile phone is connected (authorized) .

Multimedia system:

↳ Tel/🌐 ↳ Phone ↳ Connect Device

This function ensures optimal voice quality.

- ▶ Highlight the mobile phone in the device list.
- ▶ Select .
- ▶ Select **Reception Volume** or **Transmission Volume**.
- ▶ Set the volume.

Further information on the recommended reception and transmission volume: <http://www.mercedes-benz.com/connect>

Calls

Using the telephone

Multimedia system:

↳ Tel/🌐 ↳ Phone

Making a call

- ▶ Select numbers.
- ▶ Select .
- ▶ The call is made.

Accepting a call

- ▶ Select  **Accept.**

Rejecting a call

- ▶ Select  **Reject.**



Ending a call

- ▶ Select .

Activating functions during a call



- ① Adds a call
- ② Microphone status display
- ③ Ends the call
- ④ Character bar

- ▶ **To add a call:** select .
- ▶ Make the call.
- ▶ **To switch the microphone on/off:** navigate downwards.
The menu bar is shown.
- ▶ Select **Microphone On** or **Microphone Off**.
- ▶ **To end the call:** select .



- ▶ **To send DTMF tones:** enter characters using the character bar.

Conducting calls with several participants

Requirements

- the mobile phone is connected to the multimedia system .
- at least one call is added (→ page 226).

Switching between calls

- ▶ Select  (1) or  (2).
The selected call is active. The other call is on hold.

Activating or ending a call on hold

- ▶ Select  **Resume** or  **End Call**.

Conducting a conference call

- ▶ Select **Conference** in the telephone menu.
The new participant is included in the conference call.

Ending an active call

- ▶ Select .

- ⓘ On some mobile phones, the call on hold is activated as soon as the active call is ended.

Incoming call during an existing call (call waiting)

Prerequisite

There is an active call (→ page 226).

If you receive a call while already in a call, a message is displayed. An acoustic signal also sounds.

- ▶ Select  **Accept**.
The incoming call is active. The previous call is on hold.

- ▶ Select  **Reject**.

- ⓘ This function and behavior depends on your mobile phone network provider and the mobile phone (see the manufacturer's operating instructions).

Phone book

Overview of the phone book





The phone book of the mobile phone is automatically displayed in the multimedia system after the connection is established.

- 2,000 entries are reserved for permanently saved contacts in the multimedia system.
- 2,000 entries are reserved for contacts loaded from the mobile phone.

In the telephone book, you can carry out the following actions:

- searching for contacts (→ page 228).
- storing contacts (→ page 228).
- deleting contacts (→ page 229).

Symbol overview

Symbol	Explanation
	Contact stored in the multimedia system.
	Contact that was called up from a mobile phone
	Contact imported from a memory card or a USB device.
	Contact imported via the Bluetooth® interface.

Downloading mobile phone contacts

Multimedia system:

↳ Tel/🌐 » Phone » Options » Import Contacts Automatically

Automatic

▶ Allow automatic download .

Manual

- ▶ Deactivate automatic download .
- ▶ Select [Import Contacts](#).

Searching for a contact in the phone book

Multimedia system:

↳ Tel/🌐 » Phone » Phone Book

- ▶ Select characters.
- ▶ Select .
- ▶ The contact is displayed.

Changing the display and the sorting criteria for contacts

Multimedia system:

↳ Tel/🌐 » Phone » Options » Display and Sorting

The following functions are available:

- [Last Name, First Name](#)
- [Last Name First Name](#)
- [First Name Last Name](#)
- ▶ Select an option.

Saving a mobile phone contact



Multimedia system:

↳ Tel/🌐 » Phone » Phone Book

- ▶ Search for a contact on the mobile phone (→ page 228).
- ▶ Select .
- ▶ Select [Save](#).
- ▶ The contact is identified by the  symbol in the phone book.

Importing contacts into the telephone book

Via [Options](#), you can import contacts into the telephone book as electronic business cards using a memory card, USB or Bluetooth®.

Source	Requirements
 Memory card	The SD memory card is inserted.
 USB device	The USB device is inserted into the USB port.
 Bluetooth® connection	<p>If the sending of vCards is supported via Bluetooth®, vCards can be received on mobile phones or netbooks, for example.</p> <p>Bluetooth® is activated in the multimedia system and on the respective device (see the manufacturer's operating instructions).</p>

Deleting a contact from the phone book

Multimedia system:

↳ Tel/ ▶▶ Phone ▶▶ Phone Book

You can delete contacts stored in the vehicle.

- ▶ Switch off automatic download of mobile phone contacts (→ page 228).
- ▶ Highlight the contact in the phone book.
- ▶ Select .
- ▶ Select **Delete Contact**.
- ▶ Select **Yes**.

Call lists

Overview of the call lists

If your mobile phone supports the PBAP Bluetooth® profile, the call lists from the mobile phone are displayed in the multimedia system. When connecting the mobile phone, you may have to confirm the connection for the PBAP Bluetooth® profile (see manufacturer's Operator's Manual).

If your mobile phone does not support the PBAP Bluetooth® profile, the multimedia system gener-

ates its own call lists. These are not the same as the call lists in your mobile phone.

If the contact for an incoming call is not yet saved in the multimedia system, you can use the call list to save the telephone number.

Making a call from call lists

Multimedia system:

↳ Tel/ ▶▶ Phone ▶▶ Call Lists

- ▶ Select **Calls Received** or **Calls Dialed**.
- ▶ Select an entry.
- ▶ Make the call.

Displaying details from a list entry

Multimedia system:

↳ Tel/ ▶▶ Phone ▶▶ Call Lists

- ▶ Select **Calls Received** or **Calls Dialed**. The list is displayed.
- ▶ Highlight the entry.
- ▶ Select .
- ▶ Select **Details**.

Speed dial list

Calling up the speed dial list

Multimedia system:

↳ Tel/🌐 ▶▶ Phone ▶▶ Call Lists

▶ Select **Speed Dial Preset List**.

Setting up a speed dial list

Multimedia system:

↳ Tel/🌐 ▶▶ Phone ▶▶ Phone Book

▶ Select the contact.

▶ Select .

▶ Select **Assign Speed Dial Preset**.

▶ Select a preset for the speed dial.

Deleting speed dial presets

Multimedia system:

↳ Tel/🌐 ▶▶ Phone ▶▶ Call

Lists ▶▶ **Speed Dial Preset List**

Deleting a speed dial preset

▶ Highlight the preset you want to delete.

▶ Select .

▶ Select **Delete Speed Dial Preset**.

▶ Select **Yes**.

Deleting all speed dial presets

▶ Highlight a preset.

▶ Select .

▶ Select **Delete All Speed Dial Presets**.

▶ Select **Yes**.

Messages (text messages and e-mails)

Notes on messages

If the connected mobile phone supports the Bluetooth® MAP profile, the message function can be used on the multimedia system. With some mobile phones, some settings still have to be made after connecting to the multimedia system (see the manufacturer's operating instructions).

New messages are identified by the  symbol in the multimedia system display and an audible signal.

The  symbol is displayed when the mobile phone's message memory is full.

Text messages cannot be written while the vehicle is in motion.

You can obtain further information about settings and supported functions of Bluetooth®-capable mobile phones from an authorized Mercedes-Benz Center or at: <http://www.mercedes-benz.com/connect>

Text message settings

Multimedia system:

↳ Tel/🌐 ▶▶ Phone ▶▶  ▶▶ Settings

Configuring an e-mail account

▶ Select an e-mail account.

The e-mail account is now configured.

Configuring the text messages or e-mails displayed

▶ Highlight **Text Msg.** or an e-mail account.

▶ Select .

A menu with the following options is shown:

- **All Messages**
- **New Messages**

- **Off** (The messages are not displayed automatically.)

Reading messages

Multimedia system:



In the message menu

Unread messages are displayed.

- ▶ Select a message.
The message text is displayed.

In the message folder

The message menu is displayed.

- ▶ Select **Text Msg** or **Email**.
- ▶ Select a message.
The message text is displayed.

Making a call from the messages menu

Multimedia system:



Calling a text message sender

- ▶ Highlight the text message.
- ▶ Select .

- ▶ Select **Call Sender**.

Calling phone numbers from a message

- ▶ Call up a text message or e-mail.
- ▶ Select a phone number within the message.
- ▶ Select **Call Number**.

Mercedes-Benz mbrace® (USA only)

Making a call via the overhead control panel

Mercedes-Benz mbrace® is only available in the USA.

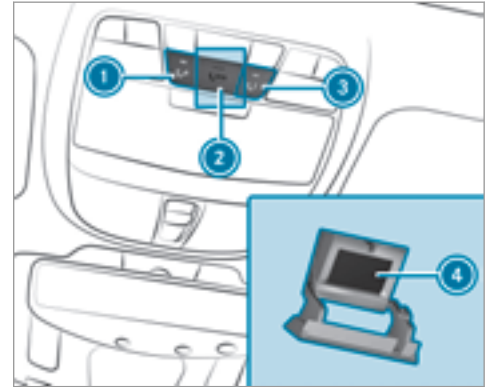

- ① Roadside Assistance call
- ② SOS button cover
- ③ MB Info call
- ④ SOS button

- ▶ **To make a Roadside Assistance call:** Press button ①.
This initiates a call to the Mercedes-Benz Customer Assistance Center.

- ▶ **To make an emergency call:** Press SOS button cover ② briefly to open.
- ▶ Press and hold SOS button ④ for at least one second.
This initiates a call to the Mercedes-Benz Customer Assistance Center.
- ▶ **To make an MB Info call:** Press button ③.
This initiates a call to the Mercedes-Benz Customer Assistance Center.

An emergency call can be initiated even if a Roadside Assistance or MB Info call is active. This has priority over all other active calls.

Calls via the overhead control panel are only possible with an available mobile phone network.

Further information on Mercedes-Benz mbrace® and other services can be found at: <http://www.mbusa.com>

Information on the emergency call system

⚠ WARNING Risk of accident and injury despite pressing the SOS button

Even if you press the SOS button in an emergency, remaining in the vehicle may be dangerous for the following reasons:

- you see smoke inside or outside of the vehicle, e.g. if there is a fire after an accident
- the vehicle is on a dangerous section of road
- the vehicle is not visible or cannot easily be seen by other road users, particularly when dark or in poor visibility conditions

- ▶ Leave the vehicle immediately in this or similar situations as soon as it is safe to do so.
- ▶ Move to a safe location along with other vehicle occupants.
- ▶ In such situations, secure the vehicle in accordance with national regulations, e.g. with a warning triangle.

Automatic emergency call

The emergency call is initiated:

- When an airbag is deployed.
- When the Emergency Tensioning Devices are triggered.

You can end an automatically initiated emergency call yourself after 60 seconds.

Manual emergency call

An emergency call can be initiated manually via the SOS button in the overhead control panel (→ page 231).

If you leave the vehicle immediately after pressing the SOS button, you do not know if Mercedes-Benz mbrace® has successfully made the emergency call.

Initiated emergency call

A voice connection between the Customer Assistance Center and the vehicle occupants is established:

- if the vehicle occupants are responsive, the Mercedes-Benz Customer Assistance Center

asks for more detailed information on the emergency.

- if no vehicle occupant answers, an ambulance is sent to the vehicle immediately.

Transferred data

During the voice connection to the Customer Assistance Center, the following data is transferred:

- Current vehicle location
- Vehicle identification number

Emergency call not possible

- if the mobile phone network is unavailable, Mercedes-Benz mbrace® is not able to make an emergency call.

A message to this effect is shown in the multifunction display.

The indicator lamp flashes continuously.

In this case, seek assistance by other means.

Information on the MB Info call

An Info call to the Mercedes-Benz Customer Assistance Center has been initiated via the overhead control panel (→ page 231).

You can find information on the following topics:

- Activating Mercedes-Benz mbrace®
- Operating the vehicle
- Nearest authorized Mercedes-Benz Center
- Other products and services from Mercedes-Benz

Data is transmitted during the connection to the Mercedes-Benz Customer Assistance Center (→ page 233).

Information on the Roadside Assistance call

A Roadside Assistance call to the Mercedes-Benz Customer Assistance Center has been initiated via the overhead control panel:

- The problem with the vehicle is analyzed using remote diagnosis.
Further information about this can be obtained at: <http://www.mbusa.com>
- A qualified Mercedes-Benz technician carries out repairs on site and/or the vehicle will be towed to the nearest authorized Mercedes-Benz Center.

You may be charged for these services.

Data is transmitted during the connection to the Mercedes-Benz Customer Assistance Center (→ page 233).

Transferred data during a service call

In certain countries you must confirm the data transfer.

Data transferred includes the following:

Overview of transferred data

Service call	Transmitted data
MB Info call Roadside Assistance call	<ul style="list-style-type: none"> • current vehicle location • vehicle identification number • service code • selected data about the status of the vehicle

Online and Internet functions

Internet connection

Setting up an Internet connection

Requirements

- A mobile phone is connected to the multimedia system via Bluetooth® .
To do so, the mobile phone must support one of the following Bluetooth® profiles:
 - DUN (Dial-Up Networking)
 - PAN (Personal Area Network)
- Set the access data of the mobile phone network provider for the connected mobile phone in the multimedia system. If you use incorrect access data, additional costs may be incurred.
- If you use the telephone module for Internet functions, you require a SIM card in the telephone module or a Bluetooth®-capable mobile phone.

You can obtain more detailed information at <http://www.mercedes-benz.com/connect> or from an authorized Mercedes-Benz Center.

Multimedia system:

↳ Tel/🌐 ➤ Tel/🌐 ➤ Internet ➤ Settings ➤ Configure Internet Settings ➤ Search for Internet Devices ➤ Start Search

- ▶ Select the mobile phone.
If the mobile phone supports the Bluetooth® PAN profile, Internet access is set up. You can use the Internet functions. If the mobile phone does not support the named Bluetooth® profile, predefined or manual access data must be set.

Selecting the predefined access data of the mobile phone network provider

- ▶ Select [Predefined Settings](#).
A list of countries appears.
- ▶ Select the country of your mobile phone network provider.
The list of available providers appears.

- ▶ Select your mobile phone network provider.
An overview of the provider settings appears.
- ▶ Select [Confirm Settings](#).

Manually setting the access data of the mobile phone network provider

- ▶ Select [Manual Settings](#).
An overview of the provider settings appears.
- ▶ Set access data.
- ▶ Select [Confirm Settings](#).
- ⓘ Set the access data in accordance with your data package. You can contact your mobile phone network provider to obtain the precise access data.

Canceling Internet access permission for a mobile phone

Multimedia system:

↳ Tel/🌐 ➤ Tel/🌐 ➤ Internet ➤ Settings ➤ Configure Internet Settings

- ▶ Highlight a mobile phone.
- ▶ Select .
- ▶ Select [Delete Configuration](#).

- ▶ Select **Yes**.

Displaying mobile phone details

Multimedia system:

↳ Tel/🌐 ▶▶ Tel/🌐 ▶▶ Internet ▶▶ Settings ▶▶ Configure Internet Settings

- ▶ Highlight a mobile phone.
- ▶ Select .
- ▶ Select **Details**.



Establishing an Internet connection

Requirements

- Your connection device is activated and operational.
- Your connection device receives a signal and has a data connection.

Multimedia system:

↳ Tel/🌐 ▶▶ Tel/🌐 ▶▶ Internet

- ▶ For example, call up the Mercedes-Benz mobile website.
- ▶ **To show the menu:** press the  button.
- ▶ **To end the connection:** select .

Mercedes-Benz Apps

Calling up Mercedes-Benz Apps

Requirements

- Register to use Mercedes-Benz Apps.
- Confirm the general terms and conditions.

Multimedia system:

↳ Tel/🌐 ▶▶ Tel/🌐 ▶▶ Internet ▶▶ Mercedes-Benz Apps

- ▶ Select the App.

Further Mercedes-Benz Apps and information can be obtained at: <http://apps.mercedes-benz.com/apps/>

- ⓘ The available features are country-dependent.
License fees may be applicable.

Web browser

Calling up a website

Multimedia system:

↳ Tel/🌐 ▶▶ Tel/🌐 ▶▶ Internet ▶▶ www

- ▶ Enter a web address.
- ▶ **To finish entry and call up a website:** select .

- ⓘ Websites cannot be shown while the vehicle is in motion.

Overview of the web browser





- ① Closes the browser
- ② Web page, back

- ③ Web page, forwards
- ④ Refreshes/stops
- ⑤ URL entry
- ⑥ Favorites
- ⑦ Disconnects
- ⑧ Options

Calling up the web browser options

Multimedia system:

↳ Tel/🌐 » Tel/🌐 » Internet » www

- ▶ Call up the website.
- ▶ **To show the menu:** press the  button.
- ▶ **To call up the options menu:** select .



The following functions are available:

- [Add to Bookmarks](#)
 - [Current URL](#)
 - [Zoom](#)
 - [Jump From Link To Link](#)
 - [Directional Scrolling](#)
 - [Settings](#)
- ▶ Select an option.

Calling up the web browser settings

Multimedia system:

↳ Tel/🌐 » Tel/🌐 » Internet » www

- ▶ Call up the website.
- ▶ **To show the menu:** press the  button.
- ▶ **To call up the options menu:** select .
- ▶ Select [Settings](#).

The following functions are available:

- [Download Images Automatically](#)
 - [Block Pop-Ups](#)
 - [Activate Javascript](#)
 - [Allow Cookies](#)
 - [Show Link Target](#)
 - [Character Size](#)
 - [Character Code](#)
- ▶ Select the setting.

Deleting Internet history

Multimedia system:

↳ Tel/🌐 » Tel/🌐 » Internet » Settings » [Delete Private Data](#)



- ▶ Select the setting.
- or
- ▶ Select [Delete All Data On Exit](#).

Setting Internet favorites

Multimedia system:

↳ Tel/🌐 » Tel/🌐 » Internet

Creating favorites

- ▶ Select [www](#).
- ▶ Call up the website.
- ▶ **To show the menu:** press the  button.
- ▶ **To call up the options menu:** select .
- ▶ Select [Add to Bookmarks](#).

Selecting favorites

- ▶ Select [Internet Favorites](#).
- ▶ Select bookmarks.

Editing favorites

- ▶ Select **Edit**.
- ▶ Enter a web address



Deleting favorites

- ▶ Select **Delete**.
- ▶ Select **Yes**.

Closing the browser

Multimedia system:

↪ Tel/🌐 ▶▶ Tel/🌐 ▶▶ Internet ▶▶ www

- ▶ **To show the menu:** press the  button.
- ▶ Select .

Media

Audio mode

Information on audio mode

⚠ WARNING Risk of distraction when handling data storage medium

If you handle a data storage medium while driving, your attention is diverted from the traffic conditions. This could also cause you to lose control of the vehicle.

▶ Only handle a data storage medium when the vehicle is stationary.

Permissible file systems:

- FAT32
- exFAT
- NTFS

Permissible data storage medium:

- SD memory card
- USB storage device

- ⓘ The multimedia system supports up to a total of 15,000 files.

Supported formats:

- MP3
- WMA
- AAC formats
- ⓘ Due to the large variety of available music files regarding encoders, sampling rates and bit rates, playback cannot always be guaranteed.
- ⓘ Due to the wide range of USB devices available on the market, playback cannot be guaranteed for all brands of USB devices.
- ⓘ Copy-protected music files or DRM encrypted files cannot be played back.
- ⓘ MP3 players must support Media Transfer Protocol (MTP).

Notes on copyright

Audio files that you create or reproduce yourself for playback are generally subject to copyright protection. In many countries, reproductions, even for private use, are not permitted without

the prior consent of the copyright holder. Make sure that you know about the applicable copyright regulations and that you comply with these.

Activating media mode

Multimedia system:

➔ Media ➔ Media

The following functions are available:

- Memory Card
- Media Interface 1
- Media Interface 2
- Bluetooth Audio

- ▶ Select the media source.
Playable music files are played back.

Inserting/removing an SD memory card

⚠ DANGER Risk of fatal injury from swallowing SD cards

SD cards are small parts.

They could be swallowed and lead to choking.

- ▶ Keep SD cards out of the reach of children.
- ▶ Seek medical attention immediately if an SD card has been swallowed.

! **NOTE** Damage caused by high temperatures

High temperatures can damage the SD memory card.

- ▶ Remove the SD memory card after use and take it out of the vehicle.

Multimedia system:

➔ Media ➔ Media ➔ Memory Card

Inserting

The multimedia connection unit is located in the stowage compartment under the armrest.

- ▶ Insert the SD memory card into the SD card slot until it engages. The side with the contacts must face downwards.
Playable music files are played back.

Removing

- ▶ Press the SD memory card.
- ▶ Eject the SD memory card.

Overview of the audio mode



- ① Active data storage medium
- ② Play mode
- ③ Track
- ④ Track number and number of tracks in the track list
- ⑤ Artist and album
- ⑥ Time with elapsed time/time remaining bar
- ⑦ Cover

Connecting USB devices

! **NOTE** Damage caused by high temperatures

High temperatures can damage USB devices.

- ▶ Remove the USB device after use and take it out of the vehicle.

The multimedia connection unit is found in the stowage compartment under the armrest and has two USB ports. Depending on the vehicle's equipment, additional USB ports may be found in the stowage compartment of the center console or the rear folding compartment.

- ▶ Connect the USB device to the USB port. Playable music files are played back only if the corresponding media display is activated.

Selecting a track

Multimedia system:

↳ Media ▶▶ Media

- ▶ Select the media source. Playable music files are played back.

Selecting a track using the current track list

- ▶ **To display the current track list:** press the touchpad and controller.
- ▶ Select a track.

Selecting a track by skipping to a track

- ▶ **To skip back or forward to a track:** navigate to the left or right.

Selecting playback options

Multimedia system:

↳ Media ▶▶ Options

Play mode

- ▶ Select **Playback Mode**.
- ▶ Select **Normal Track Sequence**. The current track list is played in the order it appears on the data storage medium.
- ▶ Select **Random Track List**. The current track list is played in random order.
- ▶ Select **Random Medium**. All tracks on the data storage medium are played in random order.

Skip to time

- ▶ Select **Skip to Time**. A menu appears.
- ▶ Set the time.

Showing track information

- ▶ Switch **Show Track Information** on or off .

Pause and playback function

Multimedia system:

↳ Media

Pausing playback

- ▶ Navigate downwards.
- ▶ Select  .

Continuing playback

- ▶ Select  .

Media search

Starting the media search

Multimedia system:

↳ Media ▶ Search

Depending on the connected media sources and files, the following categories are listed:

- [Current Track List](#)
- [Folder](#)
- [Keyword Search](#)
- [Playlists](#)
- [Artists](#)
- [Albums](#)
- [Tracks](#)
- [Genres](#)
- [Year](#)
- [Composers](#)
- [iTunes U](#) (Apple® devices)
- [Genius Mixes](#) (Apple® devices)
- [Podcasts](#) (Apple® devices)
- [Audiobooks](#) (Apple® devices)

▶ Select a category.

Media Interface

Information about the Media Interface

Media Interface is a universal interface for the connection of mobile audio equipment. The multimedia system has two USB ports. The USB ports are located in the stowage compartment under the armrest.

Supported devices

The Media Interface allows you to connect the following data storage media:

- iPod®
- iPhone®
- MP3 player
- USB devices

For details and a list of supported devices, visit our website at <http://www.mercedes-benz.com/connect>. Follow the instructions in the "Media Interface" section.

Switching on Media Interface

Multimedia system:

↳ Media ▶ Media ▶ Media Interface 1

▶ Connect the data storage medium with the USB port (→ page 239).
Playable music files are played back.

Overview of Media Interface



- ① Active data storage medium
- ② Play mode
- ③ Track
- ④ Track number and number of tracks in the track list
- ⑤ Artist and album

- ⑥ Time with elapsed time/time remaining bar
- ⑦ Cover

Bluetooth® audio

Information about Bluetooth® audio

Before using your Bluetooth® audio equipment with the multimedia system for the first time, you will need to authorize it (→ page 241).

Bluetooth® Audio overview



- ① Active data storage medium
- ② Play mode
- ③ Track display

- ④ Connected Bluetooth® audio equipment
- ⑤ Time with elapsed time/time remaining bar
- ⑥ Artist and album

Searching for and authorizing the Bluetooth® audio equipment

Requirements

Bluetooth® is activated on the multimedia system (→ page 220).

Check your Bluetooth® audio equipment for the following (see the manufacturer's operating instructions):

- the Bluetooth® audio equipment must support the A2DP and AVRCP Bluetooth® audio profiles.
- the Bluetooth® function must be activated.
- the Bluetooth® audio equipment must be "visible" for other devices.
- the Bluetooth® audio equipment must support Bluetooth® version 2.1 for connection via Secure Simple Pairing.

Multimedia system:

↳ [Media](#) ▶ [Media](#) ▶ [Bluetooth Audio](#) ▶ [Options](#) ▶ [Bluetooth Audio Devices](#) ▶ [Search for Audio Devices](#)

▶ Select [Start Search](#).

The multimedia system searches for Bluetooth® audio equipment within range and adds them to the Bluetooth® device list.

Option 1: Secure Simple Pairing

▶ Select Bluetooth® audio equipment. Authorization starts.

A code is displayed on the multimedia system and on the mobile phone.

▶ Confirm on both devices if the codes are identical.

Option 2: entering the passkey

▶ Select Bluetooth® audio equipment. The input menu for the passkey is displayed.

▶ **Multimedia system:** choose a one to sixteen-digit number combination as a passkey.

- ▶ Select OK once all the numbers have been entered.
- ▶ **Mobile phone:** enter the same passkey and confirm your entry.
After successful authorization, the Bluetooth® audio equipment is connected and starts playing.

Establishing a connection from the Bluetooth® audio equipment

The Bluetooth® device name of the multimedia system is **MB BLUETOOTH**.

- ▶ Select **Connect via Audio Device**.
- ▶ Start the authorization on your Bluetooth® audio equipment (see the manufacturer's operating instructions).
After successful authorization, the Bluetooth® audio equipment is connected and starts playing.

With some Bluetooth® audio equipment, playback must be initially started on the device itself so that the multimedia system can play the audio files.

- ⓘ Device-specific information on authorizing and connecting Bluetooth®-capable mobile phones can be obtained at <http://www.mercedes-benz.com/connect> or from an authorized Mercedes-Benz Center.

Activating Bluetooth® Audio

Multimedia system:

↳ **Media** ▶ **Media**

- ▶ Select **Bluetooth Audio**.
The multimedia system activates the connected Bluetooth® audio equipment.

Adjusting the volume on the Bluetooth® audio equipment

Multimedia system:

↳ **Media** ▶ **Media** ▶ **Bluetooth Audio** ▶ **Options** ▶ **Volume**

- ▶ Select **Standard** or **Boost**.
- ⓘ On some Bluetooth® audio equipment, the volume can be adjusted on the device (see the manufacturer's operating instructions).

Displaying Bluetooth® audio equipment details

Multimedia system:

↳ **Media** ▶ **Media** ▶ **Bluetooth Audio** ▶ **Options** ▶ **Bluetooth Audio Devices**

- ▶ Highlight Bluetooth® audio equipment and navigate to the right.
- ▶ Select **Details**.

De-authorizing (de-registering) Bluetooth® audio equipment

Multimedia system:

↳ **Media** ▶ **Media** ▶ **Bluetooth Audio** ▶ **Options** ▶ **Bluetooth Audio Devices**

- ▶ Highlight Bluetooth® audio equipment and navigate to the right.
- ▶ Select **Deauthorize**.
- ▶ Select **Yes**.
The device will be deleted from the Bluetooth® device list.

Radio

Switching on the radio

Multimedia system:

↳ Radio

- ▶ Alternatively: press the **RADIO** button. The radio display appears. You will hear the last station played on the last frequency band selected.

Radio overview



- ① Preset
- ② Display of radio station selected

- ③ Main display field with available stations and relevant information
- ④ Artist and track display

Switching HD radio on/off

Multimedia system:

↳ Radio ▶ Options ▶ HD Radio



- ▶ Activate or deactivate the function.
- ① HD Radio™ and the HD, HD radio, and “Arc” logos are proprietary trademarks of iBiquity Digital Corp.

Setting the frequency band

Multimedia system:

↳ Radio ▶ Band

HD Radio FM and HD Radio AM can be selected.

- ▶ Select a frequency band.

Selecting a radio station

Multimedia system:

↳ Radio

Using the main display field

- ▶ **To select a station:** navigate to the left or right.

Using the current station list

- ▶ Press the touchpad or the controller. The station list appears with the stations currently available.
- ▶ Select a channel.

Using direct entry

- ▶ Select **Options**.
- ▶ Select **Direct Entry**.

- ▶ Select a frequency band.
- ▶ Enter the frequency of the desired station in the entry field.

or

- ▶ Select [Station Preset](#).
- ▶ Enter the station preset of the desired station.
- ▶ Select .

Using the preset position

- ▶ Select [Preset](#).
- ▶ Select [Enter Preset](#).
- ▶ Enter the station preset of the desired station.
- ▶ Select .

Using the search function

- ▶ Select .
- ▶ Enter a search term.
- ▶ Select . Results are displayed.
- ▶ Select a channel.

Calling up the radio station list

Multimedia system:

↳ [Radio](#)

- ▶ Press the touchpad or the controller. The station list appears.
- ⓘ Each frequency range has its own station list with the stations that can currently be received.

Storing radio stations

Multimedia system:

↳ [Radio](#)

- ▶ Select [Preset](#).
- ▶ Select [Save Current Station/Channel](#).
- ▶ Select a location for storing the station.

or

- ▶ In radio mode, press and hold the touchpad or controller until the preset list appears.
- ▶ Select a location for storing the station.

Editing radio station presets

Multimedia system:

↳ [Radio](#) ▶ [Preset](#) ▶ [Edit Station Preset](#)

Deleting stations

- ▶ Highlight the preset entry and navigate to the right.
- ▶ Select [Delete Highlighted Station/Channel](#).
- ▶ Select [Yes](#).

Moving stations

- ▶ Highlight the preset entry and navigate to the right.
- ▶ Select [Move Highlighted Station/Channel](#).
- ▶ Select a location for storing the channel.

Activating/deactivating the presets view

Multimedia system:

↳ [Radio](#) ▶ [Preset](#)

- ▶ Select [Station Preset View: On](#). The radio station preset appears.

- ▶ **To switch between stored stations:** navigate to the left or right.

or

- ▶ Select **Station Preset View: Off**.
The frequency band of the station currently being played appears.

Tagging music tracks

Multimedia system:

↳ Radio ▶▶ Options

If radio stations provide the relevant information, this function allows you to transfer information on the music track currently playing to an Apple® device. You can then purchase the audio file from the iTunes Store®.

- ▶ Select **Tag This Track**.
The track information is saved.

Displaying the artist and track

Multimedia system:

↳ Radio ▶▶ Options

- ▶ Select **Show Station Information**.
- ▶ Switch the function on .

Displaying station information

Requirement

- Radio stations provide the relevant information.

Multimedia system:

↳ Radio



- ▶ Select **Information**.
Additional information is displayed.

Returning to the main display

- ▶ Select **Information**.

Satellite radio

Information on the satellite radio

SIRIUS XM® Satellite Radio offers more than 175 digital-quality radio channels providing 100% commercial-free music, sports, news and entertainment, for example. SIRIUS XM satellite radio employs a fleet of high-performance satellites to broadcast around the clock throughout the USA and Canada. The satellite radio program is available for a monthly fee. Information about this can be obtained from a Sirius XM® service center and at <http://www.siriusxm.com> (USA) or <http://www.siriusxm.ca> (Canada). Your new Mercedes-Benz vehicle comes with SIRIUS XM® Satellite Radio pre-installed at the factory. This service is free for a six-month trial period. About a month before the trial period ends, information will be provided on how to extend this subscrip-

tion. A message is shown, describing how the subscription can be extended.

i Sirius, XM and all related marks and logos are trademarks of Sirius XM Radio Inc. and its subsidiaries. All other marks, channel names and logos are the property of their respective owners. All rights reserved.

Restrictions on the satellite radio

Satellite radio mode may be temporarily unavailable or interrupted for a variety of reasons. These include environmental or topographical conditions beyond the control of Mercedes-Benz USA, LLC. Thus operation at certain locations may not be possible.

Registering satellite radio

Requirements:

The satellite radio mode requires satellite radio equipment and registration with a satellite radio provider. If registration is not included when purchasing the system, your credit card details will be required to activate your account.

Multimedia system:

↳ Radio ▶▶ Radio ▶▶ Sat Radio ▶▶ Options

- ▶ Select **Service**.
The service information screen appears and displays the service telephone number and electronic serial number (ESN).
 - ▶ Establish a telephone connection.
 - ▶ Follow the service staff's instructions.
The activation process may take up to ten minutes. If activation is completed successfully, the **Updating Channels...** message appears, followed by the satellite radio main menu.
- i** You can also have the satellite service activated online. To do so, please visit <http://www.siriusxm.com> (USA) or <http://www.siriusxm.ca> (Canada).

Switching to satellite radio

Multimedia system:

↳ Radio ▶▶ Radio

- ▶ Select **Sat Radio**.

Overview of the satellite radio



- ① Preset
- ② Channel name and channel number
- ③ Main display field with available channels and relevant information
- ④ Artist and track

Selecting a satellite radio category

Multimedia system:

↳ Radio ▶▶ Radio ▶▶ Sat Radio

- ▶ Select **Category**.
The category list appears.
- ▶ Select a category.

Selecting a satellite radio channel

Multimedia system:

↳ Radio ▶▶ Radio ▶▶ Sat Radio

Using the main display field

▶ **To select a channel:** navigate to the left or right.

or

▶ Press the controller.

By entering channel numbers directly

- ▶ Select [Options](#).
- ▶ Select [Direct Entry](#).
- ▶ Select a channel number.

Using the satellite radio channel list

- ▶ Select [Options](#).
- ▶ Select [Curr. Station List with Artist & Title](#).
- ▶ Select a channel.

Using the search function

- ▶ Select [Options](#).
- ▶ Select .

- ▶ Enter a search term.
- ▶ Select  .
Results are displayed.
- ▶ Select a channel.

Storing a satellite radio channel

Multimedia system:

↳ Radio ▶▶ Radio ▶▶ Sat Radio

- ▶ Set the channel.
- ▶ Press and hold the touchpad or controller until the preset list appears.
- ▶ Select a location for storing the channel.

Music and sport alerts function

This function makes it possible to store a program alert for your favorite artists, tracks or sporting events. Music alerts can be saved whilst a track is being played and sport alerts can be saved during a live game. You can also specify sport alerts via the menu option. The system then continuously searches through all the channels. If a match is found with a stored alert, you will be informed.

Setting music and sport alerts

Prerequisites

Activate the following functions:

- [Activate Music Alerts](#)
- [Activate Sports Alerts](#)

Multimedia system:

↳ Radio ▶▶ Radio ▶▶ Sat
Radio ▶▶ Options ▶▶ Alert for Artist, Track & Sports Event

Setting a music alert

- ▶ Select [Manage Music Alerts](#).
- ▶ Select [Select New Alerts](#).
- ▶ Select [Artist](#) or [Track](#).
The alert is set for the current artist or track. If a match is found, a prompt appears asking whether you wish to change to the channel.

Setting a sport alert

- ▶ Select [Manage Sports Alerts](#).
- ▶ Select [Select New Alerts](#).
- ▶ Select a team from a league.

Managing music and sport alerts

▶ Select [Manage Music Alerts](#).

or

▶ Select [Manage Sports Alerts](#).

Displaying satellite radio service information

Multimedia system:

↳ [Radio](#) ▶ [Radio](#) ▶ [Sat Radio](#) ▶ [Options](#)

▶ Select [Service](#).

The telephone number of the provider and the Sirius XM® ESN of your satellite receiver appear.

Displaying satellite radio channel information

Multimedia system:

↳ [Radio](#) ▶ [Radio](#) ▶ [Sat Radio](#)



▶ Select [Info](#).
Additional information is displayed.

Returning to the main display

▶ Select [Info](#).

Sound**Tone settings****Information about the sound system**

The sound system has a total output of 100 watts and is equipped with seven speakers. It is available for all functions in the radio and media modes.

Calling up the sound menu

Multimedia system:

↳ [Media](#) ▶

The following functions are available:

- [Equalizer](#)
- [Balance/Fader](#)

▶ Select the sound menu.

Adjusting treble, mid and bass

Multimedia system:

↳ [Media](#) ▶ ▶ [Equalizer](#)

▶ Select the rotary menu.

▶ Change the settings.

▶ **To exit the menu:** press the button.

Adjusting the balance/fader

Multimedia system:

↳ Media ▶▶  ▶▶ Balance/Fader

▶ Adjust the balance and fader.

▶ **To exit the menu:** press the  button.

Burmester® surround sound system

Information about the Burmester® surround sound system

The Burmester® surround sound system has a total output of 590 watts and is equipped with 13 speakers. It is available for all functions in the radio and media modes.

Calling up the sound menu in the Burmester® surround sound system

Multimedia system:

↳ Media ▶▶ 

The following functions are available:

- Equalizer
- Balance/Fader
- Surround

▶ Select the sound menu.

Adjusting the treble, mid and bass settings on the Burmester® surround sound system

Multimedia system:

↳ Media ▶▶  ▶▶ Equalizer

▶ Select the rotary menu.

▶ Change the settings.

▶ **To exit the menu:** press the  button.

Adjusting the balance/fader in the Burmester® surround sound system

Multimedia system:

↳ Media ▶▶  ▶▶ Balance/Fader

▶ Adjust the balance and fader.

▶ **To exit the menu:** press the  button.

Switching surround sound on/off in the Burmester® surround sound system

Multimedia system:

↳ Media ▶▶  ▶▶ Surround

▶ Switch the function on/off in the left rotary menu.

▶ **To exit the menu:** press the  button.

Adjusting the sound optimization in the Burmester® surround sound system

Multimedia system:

↳ Media ▶▶  ▶▶ Surround

▶ Adjust the focus in the right rotary menu.

▶ **To exit the menu:** press the  button.

ASSYST PLUS service interval display

Function of the ASSYST PLUS service interval display

The ASSYST PLUS service interval display in the Instrument Display provides information on the remaining time or distance before the next service due date.

You can hide this service message using the back button on the left-hand side of the steering wheel.

You can obtain further information concerning the servicing of your vehicle from a qualified specialist workshop, e.g. an authorized Mercedes-Benz Center.

Displaying the service due date

On-board computer:

↩ Service ➤ ASSYST PLUS

The next service due date is displayed.

▶ **To exit the display:** Press the back button on the left-hand side of the steering wheel.

Make sure to observe the following further related subject:

- Operating the on-board computer (→ page 200).

Carrying out service work at regular intervals

! **NOTE** Premature wear through failure to observe service due dates

Service work which is not carried out at the right time or incompletely can lead to increased wear and damage to the vehicle.

- ▶ Always observe the prescribed service intervals.
- ▶ Always have the prescribed service work carried out at a qualified specialist workshop.

Special service requirements

The prescribed service interval is based on normal operation of the vehicle. Service work will

need to be performed more often if the vehicle is operated under arduous conditions or increased loads, for example:

- Regular city driving with frequent intermediate stops.
- If the vehicle is primarily used to travel short distances.
- For frequent operation in mountainous terrain or on poor road surfaces.
- If the engine is often left idling for long periods.
- In particularly dusty conditions and/or if air-recirculation mode is frequently used.

In these or similar operating conditions, have, for example, the interior air filter, engine air filter, engine oil and oil filter changed more frequently. The tires must be checked more frequently if the vehicle is operated under arduous conditions. Further information can be obtained at a qualified specialist workshop.

Battery disconnection periods

The ASSYST PLUS service interval display can only calculate the service due date when the battery is connected.

- ▶ Note down the service due date displayed in the instrument display before disconnecting the battery (→ page 250).

Engine compartment

Active hood (pedestrian protection)

Operation of the active hood (pedestrian protection)

In certain accident situations, the risk of injury to pedestrians can be reduced by the actuation of the active hood. The rear area of the engine hood is raised by approximately 85 mm.

For the drive to the workshop, reset the triggered active hood yourself. If the active hood has been triggered, pedestrian protection may be limited.

A qualified specialist workshop must re-instate the full functionality of the active hood.

The active hood is not available in all countries.

Resetting the active hood

⚠ WARNING Risk of burns from hot component parts in the engine compartment

Certain component parts in the engine compartment can be very hot, e.g. the engine, the cooler and parts of the exhaust system.

- ▶ Let the engine cool down and only touch the component parts described as follows.

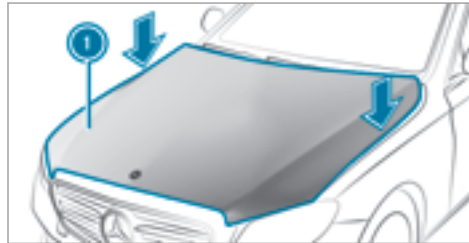

- ▶ With your hand flat, push down active hood ① in the area around the hinges on both sides (arrows). The engine hood must engage in position.
- ▶ If the active hood can be raised slightly at the rear passenger compartment in the area of the hinges, repeat the step until it engages correctly in position.

Opening/closing the hood

⚠ WARNING Risk of accident if the engine hood is unlatched while driving

An unlocked engine hood may open up when the vehicle is in motion and block your view.

- ▶ Never unlatch the engine hood while driving.
- ▶ Before every trip, ensure that the engine hood is latched.

- ⚠ WARNING** Risk of accident and injury when opening and closing the engine hood

When opening or closing the engine hood, it may suddenly drop into the end position.

There is a risk of injury for anyone in the engine hood's range of movement.

- ▶ Only open or close the engine hood when there are no persons in the engine hood's range of movement.

- ⚠ WARNING** Danger of burns when opening the hood

If you open the hood when the engine has overheated or during a fire in the engine compartment, you could come into contact with hot gases or other escaping operating fluids.

- ▶ Before opening the hood, allow the engine to cool down.

- ▶ In the event of a fire in the engine compartment, keep the hood closed and call the fire service.

- ⚠ WARNING** Risk of injury due to moving parts

Certain components in the engine compartment may continue to move or suddenly move again even after the ignition has been switched off, e.g. the cooler fan.

Make sure of the following before performing tasks in the engine compartment:

- ▶ Switch the ignition off.
- ▶ Never touch the danger zone surrounding moving component parts, e.g. the rotation area of the fan.
- ▶ Remove jewelry and watches.
- ▶ Keep items of clothing and hair away from moving parts.

- ⚠ WARNING** Risk of injury from touching component parts under voltage

The ignition system and the fuel injection system work under high voltage. If you touch component parts which are under voltage, you could receive an electric shock.

- ▶ Never touch component parts of the ignition system or the fuel injection system when the ignition is switched on.

- ⚠ WARNING** Risk of burns from hot component parts in the engine compartment

Certain component parts in the engine compartment can be very hot, e.g. the engine, the cooler and parts of the exhaust system.

- ▶ Let the engine cool down and only touch the component parts described as follows.

⚠ WARNING Risk of injury from using the windshield wipers while the engine hood is open

When the engine hood is open and the windshield wipers are set in motion, you can be trapped by the wiper linkage.

▶ Always switch off the windshield wipers and ignition before opening the engine hood.

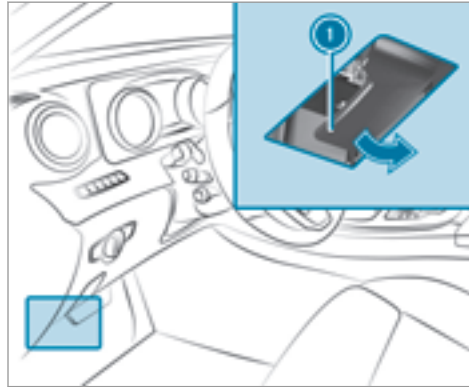

▶ **To open:** pull lever ① to release the hood.

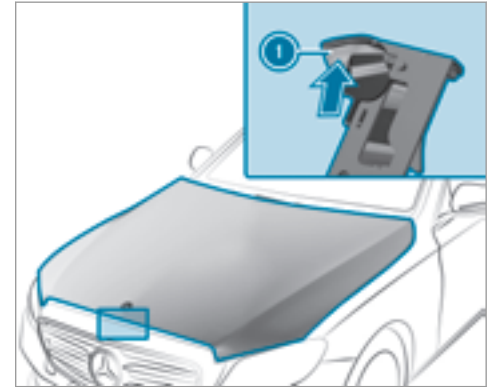

▶ Push hood catch ① upwards and lift the hood by approximately 15 in (40 cm).
 ▶ **To close:** lower the hood and let it fall from a height of approximately 8 in (20 cm).
 ▶ If the hood can still be lifted slightly, open the hood again and close it with a little more force until it engages correctly.

Engine oil

Checking the engine oil level using the oil dipstick

⚠ WARNING Risk of burns from hot component parts in the engine compartment

Certain component parts in the engine compartment can be very hot, e.g. the engine, the cooler and parts of the exhaust system.

- ▶ Let the engine cool down and only touch the component parts described as follows.

Depending on the engine, the oil dipstick may be installed in the engine compartment in different locations.

Waiting time before checking the oil level:

- Engine at normal operating temperature: five minutes.
- Engine not at normal operating temperature (e.g. the engine was only started briefly): 30 minutes.

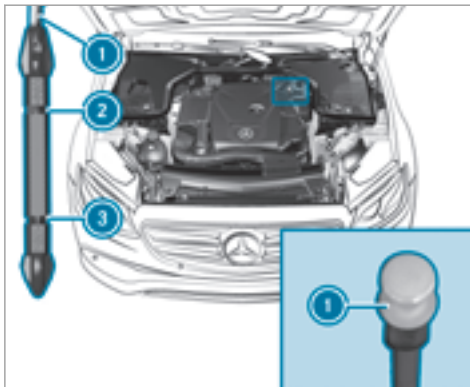

- ▶ Park the vehicle on a flat surface.
- ▶ Remove oil dipstick ① and wipe off.
- ▶ Slowly slide oil dipstick ① into the guide tube to the stop, and take it out again after approximately three seconds.
 - Oil level is correct: oil level is between ② and ③.
 - Oil level too low: oil level is at ③ or below.

- Oil level too high: oil level is above ②.

- ▶ If the oil level is too low, add 1.1 US qt (1 l) of engine oil.
- ▶ If the oil level is too high, drain off excess engine oil. Consult a qualified specialist workshop.

Topping up engine oil

⚠ WARNING Risk of burns from hot component parts in the engine compartment

Certain component parts in the engine compartment can be very hot, e.g. the engine, the cooler and parts of the exhaust system.

- ▶ Let the engine cool down and only touch the component parts described as follows.

⚠ WARNING Risk of fire and injury from engine oil

If engine oil comes into contact with hot component parts in the engine compartment, it may ignite.

- ▶ Make sure that no engine oil is spilled next to the filler opening.
- ▶ Allow the engine to cool off and thoroughly clean the engine oil from component parts before starting the vehicle.

! **NOTE** Engine damage caused by an incorrect oil filter, incorrect oil or additives

- ▶ Do not use engine oils or oil filters which do not correspond to the specifications explicitly prescribed for the service intervals.
- ▶ Do not alter the engine oil or oil filter in order to achieve longer change intervals than prescribed.
- ▶ Do not use additives.
- ▶ Follow the instructions in the service interval display regarding the oil change.

! **NOTE** Damage caused by topping up too much engine oil

Topping up too much engine oil can cause damage to the engine or the catalytic converter.

- ▶ Have excess engine oil siphoned off at a qualified specialist workshop.



- ▶ Turn cap ① counter-clockwise and remove it.
- ▶ Add engine oil.
- ▶ Replace cap ① and turn it clockwise as far as it will go.
- ▶ Check the oil level again (→ page 254).

Checking coolant level

! **WARNING** Risk of burns from hot component parts in the engine compartment

Certain component parts in the engine compartment can be very hot, e.g. the engine, the cooler and parts of the exhaust system.

- ▶ Let the engine cool down and only touch the component parts described as follows.

! **WARNING** Danger of burns from hot coolant

The engine cooling system is pressurized, particularly when the engine is warm. If you

open the cap, you could be scalded by hot coolant spraying out.

- ▶ Let the motor cool down before opening the cap.
- ▶ When opening the cap, wear gloves and protective eyewear.
- ▶ Slowly turn the cap half a turn to allow pressure to escape.

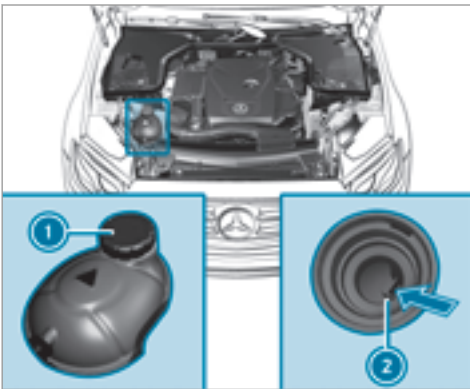

- ▶ Park the vehicle on a flat surface.
- ▶ Check the coolant temperature display in the instrument cluster. The coolant temperature must be below 158 °F (70 °C).
- ▶ Slowly turn cap ① counter-clockwise to relieve overpressure.
- ▶ Continue turning cap ① counter-clockwise and remove it.

The coolant level is correct:

- If the engine is cold, up to marker bar ②
 - If the engine is warm, up to 0.6 in (1.5 cm) over marker bar ②
- ▶ If necessary, add coolant that has been tested and approved by Mercedes-Benz.
- Further information on coolant (→ page 322)

Refilling the windshield washer system

⚠ WARNING Risk of burns from hot component parts in the engine compartment

Certain component parts in the engine compartment can be very hot, e.g. the engine, the cooler and parts of the exhaust system.

- ▶ Let the engine cool down and only touch the component parts described as follows.

⚠ WARNING Danger of burns when opening the engine hood

If you open the engine hood when the engine has overheated or during a fire in the engine compartment, you could come into contact with hot gases or other escaping operating fluids.

- ▶ Before opening the engine hood, allow the engine to cool down.
- ▶ In the event of a fire in the engine compartment, keep the engine hood closed and call the fire service.

⚠ WARNING - Risk of fire and injury from windshield washer concentrate

Windshield washer concentrate is highly flammable. It could ignite if it comes into contact with hot engine component parts or the exhaust system.

- ▶ Make sure that no windshield washer concentrate spills out next to the filler opening.

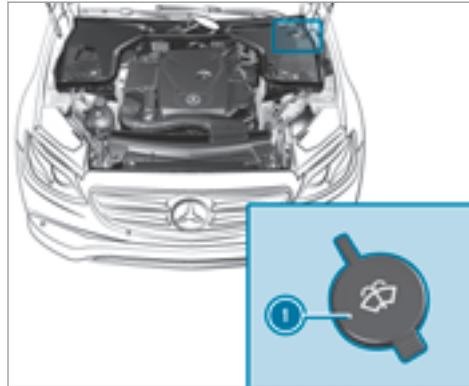

- ▶ Remove cap ① by the tab.
- ▶ Add washer fluid.

Cleaning and care

Information on washing the vehicle in a car wash

⚠ WARNING Risk of accident due to reduced braking effect after washing the vehicle

The braking effect is reduced after washing the vehicle.

- ▶ After the vehicle has been washed, brake carefully while paying attention to the traffic conditions until the braking effect has been fully restored.

To avoid damage to your vehicle when using a car wash, ensure the following beforehand:

- Distance Pilot DISTRONIC and the HOLD function are switched off.
- The 360° Camera or the reversing camera is switched off.
- The side windows and sliding sunroof are completely closed.

- The blower for the ventilation/heating is switched off.
- The windshield wiper switch is in position **0**.
- In car washes with a towing mechanism: neutral **N** is engaged.
- The SmartKey is at a distance of at least 10 ft (3 m) away from the vehicle, otherwise the tailgate could open unintentionally.

i If you remove the wax from the windshield and the wiper rubber after the car wash you will avoid smearing and reduce the noise made by the windshield wipers.

Information on using a power washer

⚠ WARNING Risk of accident when using high-pressure cleaning equipment with round-spray nozzles

The water jet from a round-spray nozzle (dirt grinder) may cause damage to tires and suspension components that is not visible.

Components damaged in this way may fail unexpectedly.

- ▶ Do not use high-pressure cleaning equipment with round-spray nozzles to clean your vehicle.
- ▶ Damaged tires or suspension components must be replaced immediately.

To avoid damage to your vehicle, observe the following when using a power washer:

- Keep the SmartKey at least 10 ft (3 m) away from the vehicle. Otherwise the tailgate could open unintentionally.
- Maintain a distance of at least 11.8 in (30 cm) to the vehicle.
- **Vehicles with decorative foil:** parts of your vehicle are covered with a decorative foil. Maintain a distance of at least 27.6 in (70 cm) between the foil-covered parts of the vehicle and the nozzle of the power washer. Move the power washer cleaner nozzle around whilst cleaning.

- Observe the information on the correct distance in the equipment manufacturer's operating instructions.
- Do not point the nozzle of the power washer directly at sensitive parts such as tires, slits, electrical component parts, batteries, light sources and ventilation slots.

Washing the vehicle by hand

Observe legal requirements, for example in some countries washing by hand is only allowed at specially equipped washing bays.

- ▶ Use a mild cleaning agent such as car shampoo.
- ▶ Wash the vehicle with lukewarm water and a soft car sponge. While doing so, do not expose the vehicle to direct sunlight.
- ▶ Hose down the vehicle carefully with water and dry it with a leather cloth. Make sure that the water jet is not pointed directly into the air inlet grille.

Notes on paintwork/matte finish paintwork care

Observe the following information:

	Information on cleaning and care	Avoiding damage to the paintwork
Paint	<ul style="list-style-type: none"> • Insect remains: soak with insect remover and rinse off the treated areas afterwards. • Bird droppings: soak with water and rinse off afterwards. • Coolant, brake fluid, tree resins, oils, fuel and greases: gently rub with a cloth soaked in petroleum ether or lighter fluid. • Tar stains: use tar remover. • Wax: use silicone remover. 	<ul style="list-style-type: none"> • Do not apply stickers, films etc. • Remove dirt immediately, where possible.
Matte finish	<ul style="list-style-type: none"> • The vehicle should preferably be washed by hand using a soft sponge, car shampoo and plenty of water. • Only use care products recommended by Mercedes-Benz. 	<ul style="list-style-type: none"> • Do not polish the vehicle and light-alloy wheels. • Do not have your vehicle cleaned at an automatic car wash too frequently and do not use wash programs which finish with a hot wax vehicle treatment. • Do not use paint cleaner, buffing or polishing products such as a gloss preserver, e.g. wax. • Always have paintwork repairs carried out at a qualified specialist workshop.

Notes on care of vehicle parts

⚠ WARNING Risk of entrapment if the windshield wipers are switched on while the windshield is being cleaned

If the windshield wipers are set in motion while you are cleaning the windshield or wiper blades, you can be trapped by the wiper arm.

▶ Always switch off the windshield wipers and the ignition before cleaning the windshield or wiper blades.

⚠ WARNING Risk of burns from tailpipes and tailpipe trim

The tailpipe and tailpipe trim can become very hot. If you come into contact with these parts of the vehicle, you could burn yourself.

▶ Always be particularly careful around the tailpipe and the tailpipe trim.
▶ Allow the vehicle parts to cool down before you touch them.

Observe the following information:

Information on cleaning and care		Avoiding vehicle damage
Wheels/rims	Use water and acid-free wheel cleaners.	<ul style="list-style-type: none"> Do not use acidic wheel cleaners to remove brake dust. This could damage wheel bolts and brake components. To avoid corrosion of the brake discs and brake linings, drive the vehicle for a few minutes after cleaning before parking it. The brake discs and brake linings warm up and dried out.
Windows	Clean the windows on the inside and outside using a damp cloth and cleaning products recommended by Mercedes-Benz.	Do not use dry cloths, abrasive products or cleaning agents containing solvents to clean the inside of the windows.

Information on cleaning and care		Avoiding vehicle damage
Wiper blades	Fold out the wiper blades and clean them using a damp cloth.	Do not clean the wiper blades too often.
Exterior lighting	Clean the lens with a wet sponge and mild detergent, e.g. car shampoo.	Only use cleaning agents or cleaning cloths that are suitable for plastic lenses.
AIRPANEL	<p>If the vehicle is very dusty or there are salt deposits in the AIRPANEL mechanics, the adjustment range of the shutters in the radiator trim may be restricted.</p> <ul style="list-style-type: none"> • Switch on the ignition, and the shutters open automatically after approximately 120 seconds. • Clean the bearing points of the shutters with a high-pressure water jet. 	When using a high-pressure water jet, maintain a minimum distance of 11.8 in (30 cm).
Sensors	Clean the sensors in the front and rear bumpers and in the radiator grille with a soft cloth and car shampoo.	When using a high-pressure water jet, maintain a minimum distance of 11.8 in (30 cm).
Rear view camera and 360° Camera	<ul style="list-style-type: none"> • Open the camera cover with the multimedia system(→ page 184) . • Use clear water and a soft cloth to clean the camera lens. 	Do not use a high-pressure water jet.
Tailpipes	Clean with cleaning agents recommended by Mercedes-Benz, particularly in the winter and after washing the vehicle.	Use acid-free cleaning agents.

Notes on care of the interior

⚠ WARNING Risk of injury from plastic parts breaking off after the use of solvent-based care products

Care and cleaning products containing solvents can cause surfaces in the cockpit to become porous.

When the airbags are deployed, plastic parts may break away.

▶ Do not use any care or cleaning products containing solvents to clean the cockpit.

⚠ WARNING Risk of injury or death from bleached seat belts

Bleaching or dyeing seat belts can severely weaken them.

This can, for example, cause seat belts to tear or fail in an accident.

▶ Never bleach or dye seat belts.

Observe the following information:

Information on cleaning and care		Avoiding vehicle damage
Seat belts	Clean with warm water and soap solution.	<ul style="list-style-type: none"> Do not use chemical cleaning agents. Do not dry seat belts by heating them to over 176 °F (80 °C) or exposing them to direct sunlight.
Display	Clean the surface carefully with a microfiber cloth and TFT/LCD display cleaner.	<ul style="list-style-type: none"> Switch off the display and allow to cool. Do not use any other cleaning products.
Plastic trim	<ul style="list-style-type: none"> Clean with a damp microfiber cloth. If the trim is very dirty: use a cleaning agent recommended by Mercedes-Benz. 	<ul style="list-style-type: none"> Do not apply stickers, films etc. Do not allow cosmetics, insect repellent or sun cream to come in contact with the plastic trim.

Information on cleaning and care		Avoiding vehicle damage
Genuine wood/trim elements	<ul style="list-style-type: none"> • Clean with a microfiber cloth. • Black piano-lacquer look: clean with a damp cloth and soap solution. • If the trim is very dirty: use a cleaning agent recommended by Mercedes-Benz. 	Do not use solvent-based cleaning agents, polishes or waxes.
Roof lining	Clean with a brush or dry shampoo.	
Carpet	Use carpet and textile cleaning agents recommended by Mercedes-Benz.	
Genuine leather seat covers	<ul style="list-style-type: none"> • Clean with a damp cloth and then wipe with a dry cloth. • Leather care: use leather care agents that have been recommended by Mercedes-Benz. 	Do not allow the leather to become too damp. Do not use a microfiber cloth.
DINAMICA seat covers	Clean with a damp cloth.	Do not use a microfiber cloth.
Artificial leather seat covers	Clean with a damp cloth and 1% soap solution.	Do not use a microfiber cloth.
Cloth seat covers	Clean with a damp cloth and 1% soap solution and allow to dry.	

Emergency

Removing the safety vest

The safety vests are located in the safety vest compartments in the driver's and front passenger door stowage compartments.

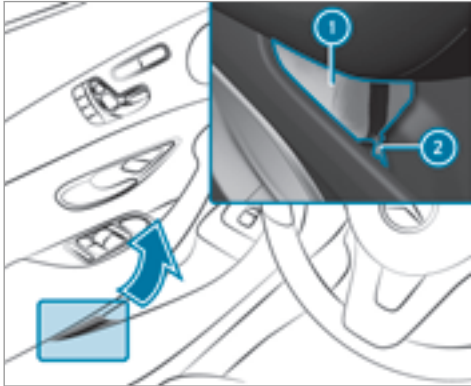

To remove: pull out safety vest bag ① by loop ②.

▶ Open safety vest bag ① and pull out the safety vest.

① There are also safety vest compartments in the rear door stowage compartments in which safety vests can be stowed.

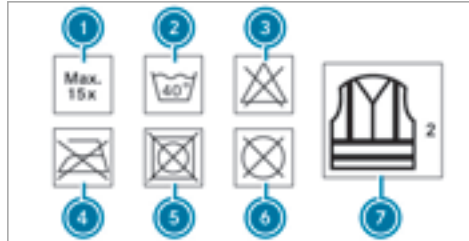

- ① Maximum number of washes
- ② Maximum wash temperature
- ③ Do not bleach
- ④ Do not iron
- ⑤ Do not use a laundry dryer
- ⑥ Do not dry-clean
- ⑦ This is a class 2 vest

The requirements defined by the legal standard are only fulfilled if the safety vest is the correct size and is fully closed.

Replace the safety vest if:

- It is damaged or dirt on the reflective strips can no longer be removed.
- The maximum number of washes is exceeded.
- The fluorescence of the safety vest has faded.

Flat tire

Notes on flat tires

⚠ WARNING Risk of accident due to a flat tire

A flat tire severely affects the driving characteristics as well as the steering and braking of the vehicle.

Tires without run-flat characteristics:

- ▶ Do not drive on with a flat tire.

- ▶ Change the flat tire immediately with the emergency spare wheel or spare wheel. Alternatively, consult a qualified specialist workshop.

Tires with run-flat characteristics:

- ▶ Observe the information and warning notes on MOExtended tires (run-flat tires).

In the event of a flat tire, the following options are available depending on your vehicle's equipment:

- **Vehicles with MOExtended tires:** it is possible to continue the journey for a short period of time. Make sure you observe the notes on MOExtended tires (run-flat tires) (→ page 265).
- **Vehicles with a TIREFIT kit:** you can repair the tire so that it is possible to continue the journey for a short period of time. To do this, use the TIREFIT kit (→ page 266).
- **Vehicles with a Mercedes-Benz emergency call system:** in the event of a break-

down, consult the Mercedes-Benz emergency call system Customer Assistance Center.

- Change the wheel (→ page 308).

MOExtended tires (run-flat tires)

With MOExtended tires (run-flat tires), you can continue to drive your vehicle even if there is a total loss of pressure in one or more tires. However, the tire affected must not show any clearly visible damage.

You can recognize MOExtended tires by the MOExtended marking which appears on the side wall of the tire.

Vehicles with a tire pressure monitoring system: MOExtended tires may only be used in conjunction with an activated tire pressure monitoring system.

If a pressure loss warning message appears in the multifunction display:

- Check the tire for damage
- If driving on, observe the following notes

⚠ WARNING Risk of accident when driving in limp-home mode

When driving in limp-home mode, the handling characteristics are impaired. e.g. when cornering, when accelerating strongly and when braking.

- ▶ Do not exceed the maximum permissible speed.
- ▶ Avoid any abrupt steering and driving maneuvers as well as driving over obstacles (curbs, pot holes, cross-country). This applies, in particular, to a loaded vehicle.
- ▶ Stop driving in limp-home mode if you notice:
 - banging noise
 - vehicle vibration
 - smoke which smells like rubber
 - continuous ESP® intervention
 - cracks in tire side walls
- ▶ After driving in limp-home mode, have the rims checked by a qualified special-

ist workshop with regard to their further use.

- ▶ The defective tire must be replaced in every case.

Driving distance possible in limp-home mode after the pressure loss warning

Load condition	Driving distance possible in limp-home mode
Partially laden	50 miles (80 km)
Fully laden	19 miles (30 km)

- The driving distance possible in limp-home mode may vary depending on the driving style.
- Maximum permissible speed 50 mph (80 km/h).

If a tire has gone flat and cannot be replaced with an MOExtended tire, a standard tire may be used as a temporary measure.

TIREFIT kit storage location

The TIREFIT kit is located under the cargo compartment floor.



- ① Tire inflation compressor
- ② Tire sealant bottle

Using the TIREFIT kit

Have the following readily available:

- Tire sealant bottle
- Enclosed TIREFIT sticker
- Tire inflation compressor

You can use TIREFIT tire sealant to seal punctures of up to 0.16 in (4 mm), particularly those in the tire contact surface. You can use TIREFIT in outside temperatures down to -4°F (-20°C).

⚠ WARNING Risk of accident when using tire sealant.

In the following situations, the tire sealant is unable to provide sufficient breakdown assistance, as it is unable to seal the tire properly:

- There are cuts or punctures in the tire larger than those previously mentioned.
- The wheel rim is damaged.
- You have driven at a very low tire pressure or on a flat tire.

- ▶ Do not continue driving.
- ▶ Consult a qualified specialist workshop.

⚠ WARNING Risk of injury and poisoning from tire sealant

The tire sealant is harmful and causes irritation. Do not allow it to come into contact

with the skin, eyes or clothing, and do not swallow it. Do not inhale tire sealant fumes. Keep the tire sealant away from children.

If you come into contact with the tire sealant, observe the following:

- ▶ Rinse off the tire sealant from your skin immediately using water.
- ▶ If tire sealant gets into your eyes, thoroughly rinse out the eyes using clean water.
- ▶ If tire sealant has been swallowed, immediately rinse out the mouth thoroughly and drink plenty of water. Do not induce vomiting and seek medical attention immediately.
- ▶ Change out of any clothes contaminated with tire sealant immediately.
- ▶ If allergic reactions occur, seek medical attention immediately.

1 **NOTE** Overheating due to the tire inflation compressor running too long

- ▶ Do not run the tire inflation compressor for longer than ten minutes without interruption.

Comply with the manufacturer's safety notes on the sticker on the tire inflation compressor.

Have the tire sealant bottle replaced every four years at a qualified specialist workshop.

- ▶ Do not remove any foreign objects which have penetrated the tire.

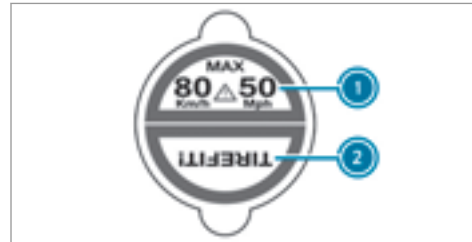

- ▶ Affix part ① of the TIREFIT sticker to the instrument cluster within the driver's field of vision.
- ▶ Affix part ② of the TIREFIT sticker near the valve on the wheel with the defective tire.

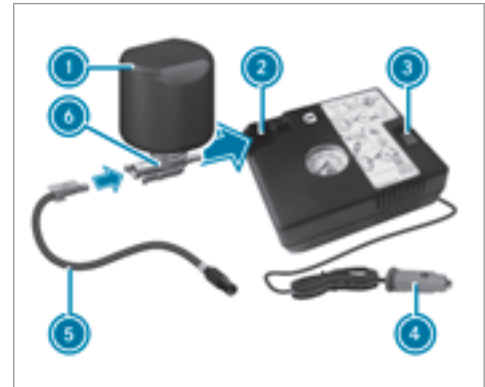

- ▶ Pull plug ④ with the cable and hose ⑤ out of the tire inflation compressor housing.

- ▶ Push the plug of hose ⑤ into flange ⑥ of tire sealant bottle ① until the plug engages.
- ▶ Place tire sealant bottle ① head downward into recess ② of the tire inflation compressor.



- ▶ Remove the cap from valve ⑦ on the defective tire.
- ▶ Screw filling hose ⑧ onto valve ⑦.
- ▶ Insert plug ④ into a 12 V socket in your vehicle.
- ▶ Switch the ignition on.

- ▶ Press on and off switch ③ on the tire inflation compressor. The tire inflation compressor is switched on. The tire is inflated. First, tire sealant is pumped into the tire. The pressure may briefly rise to approximately 500 kPa (5 bar/73 psi).

Do not switch off the tire inflation compressor during this phase.

- ▶ Let the tire inflation compressor run for a maximum of ten minutes. The tire should then have attained a tire pressure of at least 200 kPa (2.0 bar/29 psi).

If tire sealant leaks out, make sure you clean the affected area as quickly as possible. It is preferable to use clean water.

If you get tire sealant on your clothing, have it cleaned as soon as possible with perchloroethylene.

If, after ten minutes, a tire pressure of 200 kPa (2.0 bar/29 psi) has not been reached:

- ▶ Switch off the tire inflation compressor.
- ▶ Unscrew the filling hose from the valve of the defective tire.

Please note that tire sealant may leak out when unscrewing the filling hose.

- ▶ Very slowly drive forward or reverse approximately 33 ft (10 m).
- ▶ Pump up the tire again. After a maximum of ten minutes the tire pressure must be at least 200 kPa (2.0 bar/29 psi).

⚠ WARNING Risk of accident due to the specified tire pressure not being reached

If the specified tire pressure is not reached after the specified time, the tire is too badly damaged. The tire sealant cannot repair the tire in this instance.

Damaged tires and a tire pressure that is too low can significantly impair braking and handling characteristics.

- ▶ Do not continue driving.
- ▶ Consult a qualified specialist workshop.

If, after ten minutes, a tire pressure of 200 kPa (2.0 bar/29 psi) has been reached:

⚠ WARNING Risk of accident from driving with sealed tires

A tire temporarily sealed with tire sealant impairs the handling characteristics and is not suitable for higher speeds.

- ▶ Adapt your driving style accordingly and drive carefully.
- ▶ Do not exceed the specified maximum speed with a tire that has been repaired using tire sealant.

- ▶ Observe the maximum permissible speed for a tire sealed with tire sealant 50 mph (80 km/h).

- ▶ Affix the upper section of the TIREFIT sticker to the instrument cluster where it will be easily seen by the driver.

! **NOTE** Staining caused by leaking tire sealant

After use, excess tire sealant may leak out from the filling hose.

- ▶ Therefore, place the filling hose in the plastic bag that contained the TIREFIT kit.

🔥 ENVIRONMENTAL NOTE Environmental pollution caused by environmentally irresponsible disposal

Tire sealant contains pollutants.

- ▶ Have the tire sealant bottle disposed of professionally, e.g. at a Mercedes-Benz service center.

- ▶ Switch off the tire inflation compressor.
- ▶ Unscrew the filling hose from the valve of the defective tire.

- ▶ Stow the tire sealant bottle, the tire inflation compressor and the warning triangle.

▶ Pull away immediately.

- ▶ Stop after driving for approximately ten minutes and check the tire pressure using the tire inflation compressor. The tire pressure must now be at least 130 kPa (1.3 bar/19 psi).

⚠ WARNING Risk of accident due to the specified tire pressure not being reached

If the specified tire pressure is not reached after a brief drive, the tire is too badly damaged. The tire sealant cannot repair the tire in this instance.

Damaged tires and tire pressure that is too low can significantly impair the braking properties and the handling characteristics.

- ▶ Do not continue driving.
- ▶ Consult a qualified specialist workshop.

In cases such as the one mentioned above, contact an authorized Mercedes-Benz Center. Or

call 1-800-FOR-MERCEdes (in the USA) or 1-800-387-0100 (in Canada).

- ▶ Correct the tire pressure if it is still at least 130 kPa (1.3 bar/19 psi). See the Tire and Loading Information placard on the driver's side B-pillar or the tire pressure table in the fuel filler flap for values.
- ▶ **To increase the tire pressure:** switch on the tire inflation compressor.

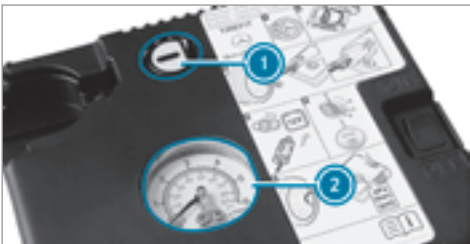

- ▶ **To reduce the tire pressure:** press pressure release button ① next to manometer ②.

- ▶ When the tire pressure is correct, unscrew the filling hose from the valve of the sealed tire.
- ▶ Screw the valve cap onto the tire valve of the sealed tire.
- ▶ Pull the tire sealant bottle out of the tire inflation compressor. The filling hose stays on the tire sealant bottle.
- ▶ Drive to the nearest qualified specialist workshop and have the tire, tire sealant bottle and filling hose replaced there.

Battery (vehicle)

Notes on the 12 V battery

⚠ WARNING Risk of an accident due to work carried out incorrectly on the battery

Work carried out incorrectly on the battery can, for example, lead to a short circuit. This can lead to function restrictions in safety-rel-

evant systems, for example the lighting system, ABS (anti-lock braking system) or ESP® (Electronic Stability Program). The operating safety of your vehicle may be restricted.

You could lose control of the vehicle in the following situations:

- when braking
 - in the event of abrupt steering maneuvers and/or when the vehicle's speed is not adapted to the road conditions
- ▶ In the event of a short circuit or a similar incident, contact a qualified specialist workshop immediately.
 - ▶ Do not continue driving.
 - ▶ Always have work on the battery carried out at a qualified specialist workshop.

- Further information on ABS (→ page 155)
- Further information on ESP® (→ page 156)

For safety reasons, Mercedes-Benz recommends that you only use batteries which have been tested and approved for your vehicle by Mercedes-

Benz. These batteries provide increased impact protection to prevent vehicle occupants from suffering acid burns should the battery be damaged in the event of an accident.

All vehicles except vehicles with a lithium-ion battery

⚠ WARNING Risk of explosion due to electrostatic charge

Electrostatic charge can cause sparks which may ignite the highly flammable gas mixture in the battery.

- ▶ To discharge any electrostatic charge that may have built up, touch the metal vehicle body before handling the battery.

The highly flammable gas mixture is created while the battery is charging and during starting assistance.

⚠ WARNING Danger of chemical burns from the battery acid

Battery acid is caustic.

- ▶ Avoid contact with the skin, eyes or clothing.
- ▶ Do not lean over the battery.
- ▶ Do not inhale battery gases.
- ▶ Keep children away from the battery.
- ▶ Immediately rinse battery acid off thoroughly with plenty of clean water and seek medical attention immediately.

All vehicles

🔥 ENVIRONMENTAL NOTE Environmental damage caused by improper disposal of batteries



Batteries contain pollutants. It is illegal to dispose of them with the household rubbish.



Dispose of batteries in an environmentally responsible manner. Take discharged batteries to a qualified specialist workshop or to a collection point for used batteries.

If you have to connect the 12 volt battery, contact a qualified specialist workshop.

Comply with safety notes and take protective measures when handling batteries.



Risk of explosion



Fire, open flames and smoking are prohibited when handling the battery. Avoid creating sparks.



Electrolyte or battery acid is corrosive. Avoid contact with the skin, eyes or clothing. Wear suitable protective clothing, in particular gloves, an

apron and a face mask. Immediately rinse electrolyte or acid splashes off with clean water. Consult a doctor if necessary.

Wear safety glasses.



Keep children away.



Observe this Operator's Manual.



If you do not intend to use the vehicle over an extended period of time:

- Activate standby mode, or
- Connect the battery to a battery charger approved by Mercedes-Benz, or
- Consult a qualified specialist workshop to disconnect the battery.

Starting assistance and charging the 12 V battery

Vehicles with a lithium-ion battery

- ▶ When charging the battery and during starting assistance, always use the jump-start connection point in the engine compartment.

! **NOTE** Damage to the battery from over-voltage

When charging using a battery charger without a maximum charging voltage, the battery or the on-board electronics may be damaged.

- ▶ Only use battery chargers with a maximum charging voltage of 14.4 V.

All other vehicles

- ▶ When charging the battery and during starting assistance, always use the jump-start connection point in the engine compartment.

! **NOTE** Damaging the battery through overvoltage

When charging using a battery charger without a maximum charging voltage, the battery or the vehicle electronics may be damaged.

- ▶ Only use battery chargers with a maximum charging voltage of 14.8 V.

! **WARNING** Risk of explosion from hydrogen gas igniting

A battery generates hydrogen gas during the charging process. If there is a short circuit or sparks start to form, there is a danger of the hydrogen gas igniting.

- ▶ Make sure that the positive terminal of the connected battery does not come into contact with vehicle parts.
- ▶ Never place metal objects or tools on a battery.
- ▶ When connecting and disconnecting the battery, you must observe the described order for the battery clamps.

- ▶ When giving starting assistance, always make sure that you only connect battery terminals with identical polarity.
- ▶ During starting assistance, you must observe the described order for connecting and disconnecting the jumper cables.
- ▶ Do not connect or disconnect the battery clamps while the engine is running.

⚠ WARNING Risk of explosion during charging process and starting assistance

During the charging process and starting assistance, the battery may release an explosive gas mixture.

- ▶ Avoid fire, open flames, creating sparks and smoking.
- ▶ Make sure that there is sufficient ventilation during the charging process and during starting assistance.
- ▶ Do not lean over a battery.

If the indicator/warning lamps in the instrument cluster do not light up at low temperatures, it is very likely that the discharged battery has frozen.

⚠ WARNING Risk of explosion from a frozen battery

A discharged battery may freeze at temperatures slightly above or below freezing point. During starting assistance or battery charging, battery gas may be released.

- ▶ Always thaw a frozen battery out first before charging it or performing starting assistance.

! NOTE Shortening the service life of the battery by charging the battery at low temperatures

Charging the battery at very low temperatures may shorten the service life of the battery and have a negative effect on starting.

- ▶ Do not charge the battery at very low temperatures.

The service life of a battery that has been thawed may be dramatically shortened.

It is recommended that you have a thawed battery checked at a qualified specialist workshop.

All vehicles

! NOTE Damage caused by numerous or extended attempts to start the engine

Numerous or extended attempts to start the engine may damage the catalytic converter due to non-combusted fuel.

- ▶ Avoid numerous and extended attempts to start the engine.

Observe the following points during starting assistance and when charging the battery:

- Only use undamaged jumper cables/charging cables with a sufficient cross-section and insulated terminal clamps.
- Non-insulated parts of the terminal clamps must not come into contact with other metal parts while the jumper cable/charging cable is connected to the battery/jump-start connection point.

- The jumper cable/charging cable must not come into contact with any parts which may move when the engine is running.
- Always make sure that neither you nor the battery is electrostatically charged.
- Keep away from fire and open flames.
- Do not lean over the battery.
- **When charging:** only use battery chargers tested and approved by Mercedes-Benz and read the battery charger's operating instructions before charging the battery.

Observe the additional following points during starting assistance:

- Starting assistance may only be provided using batteries with a nominal voltage of 12 V.
 - The vehicles must not touch.
 - **Gasoline engine:** Only accept starting assistance if the engine is cold and the exhaust system has cooled down.
- ▶ Secure the vehicle by applying the electric parking brake.

- ▶ **Automatic transmission:** Shift the transmission to position **P**.
- ▶ Make sure that the ignition and all electrical consumers are switched off.
- ▶ Open the hood.

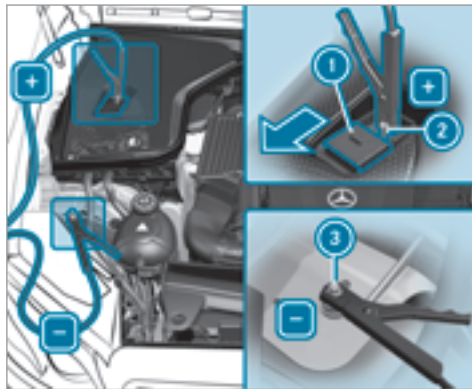

- ▶ Slide cover **1** of positive clamp **2** on the jump-starting connection point in the direction of the arrow.

- ▶ Connect positive clamp **2** on your vehicle to the positive pole of the donor battery using the jumper cable/charging cable. Always begin with positive clamp **2** on your own vehicle first.
- ▶ **During the starting assistance procedure:** start the engine of the donor vehicle and run at idle speed.
- ▶ Connect the negative pole of the donor battery and ground point **3** of your own vehicle using the jumper cable/charging cable. Begin with the donor battery first.
- ▶ **During starting assistance:** start the engine of your own vehicle.
- ▶ **During the charging process:** start the charging process.
- ▶ **During starting assistance:** let the engines run for several minutes.
- ▶ **During starting assistance:** before disconnecting the jumper cable, switch on an electrical consumer on your own vehicle, e.g. the rear window heater or lighting.

When the starting assistance/charging process is complete:

- ▶ First, remove the jumper cable/charging cable from ground point ③ and the negative pole of the donor battery, then from positive clamp ② and the positive pole of the donor battery. Begin each time with the contacts on your own vehicle first.
- ▶ After removing the jumper cable/charging cable, close cover ① of positive clamp ②.

You can obtain further information on starting assistance at any qualified specialist workshop.

Tow starting or towing away



Permitted towing methods

Mercedes-Benz recommends transporting your vehicle in the case of a breakdown, rather than towing it away.

! **NOTE** Damage to the vehicle due to towing away incorrectly

▶ Observe the instructions and notes on towing away.

Permitted towing methods

	 Both axles on the ground	 Front axle raised	 Rear axle raised
Vehicles with manual transmission	Yes, maximum 31 miles (50 km) at 31 mph (50 km/h)	Yes, maximum 31 miles (50 km) at 31 mph (50 km/h)	Yes, maximum 31 miles (50 km) at 31 mph (50 km/h)
Vehicles with automatic transmission	Yes, maximum 31 miles (50 km) at 31 mph (50 km/h)	No	Yes, if the steering wheel is fixed in the center position with a steering wheel lock.
4MATIC vehicles	Yes, maximum 31 miles (50 km) at 31 mph (50 km/h)	No	No

Towing with a raised axle: towing should be performed by a towing company.

Towing the vehicle with both axles on the ground

► Observe the notes on the permitted towing methods (→ page 276) (→ page 275).

► Make sure that the battery is connected and charged.

When the battery is discharged:

- The engine cannot be started.
- The electric parking brake cannot be released or applied.

- **Vehicles with automatic transmission:** The automatic transmission cannot be shifted to position **N** or **P**.

i Vehicles with automatic transmission: If the automatic transmission cannot be shifted to position **N**, transport the vehicle (→ page 278). A towing vehicle with lifting equipment is required for vehicle transport.

! NOTE Damage due to towing away at excessively high speeds or over long distances

The drivetrain could be damaged when towing at excessively high speeds or over long distances.

- ▶ A towing speed of 31 mph (50 km/h) must not be exceeded.
- ▶ A towing distance of 31 miles (50 km) must not be exceeded.

! WARNING Risk of accident when towing a vehicle which is too heavy

If the vehicle being tow-started or towed away is heavier than the permissible gross mass of your vehicle, the following situations can occur:

- The towing eye may become detached.
 - The vehicle/trailer combination may swerve or even overturn.
- ▶ If another vehicle is tow-started or towed away, its weight must not exceed the permissible gross mass of your own vehicle.

If a vehicle must be tow-started or towed away, its weight must not exceed the permissible gross mass of the towing vehicle.

- ▶ Information on the permissible gross mass of the vehicle can be found on the vehicle identification plate .
- ▶ **Vehicles with automatic transmission:** Do not open the driver's door or front passenger

door, otherwise the automatic transmission automatically shifts to position **P**.

- ▶ Install the towing eye (→ page 280).
- ▶ Attach the tow bar.

! NOTE Damage due to incorrect connection

- ▶ Only connect the tow rope or tow bar to the towing eyes.

- ▶ Deactivate the automatic locking mechanism (→ page 58).
- ▶ Do not activate the HOLD function.
- ▶ Deactivate Active Brake Assist (→ page 163).
- ▶ **Vehicles with automatic transmission:** Shift the automatic transmission to position **N**.
- ▶ Release the electric parking brake.

⚠ WARNING Risk of accident due to limited safety-related functions during the towing process

Safety-related functions are limited or no longer available in the following situations:

- the ignition is switched off.
- the brake system or power steering system is malfunctioning.
- the energy supply or the on-board electrical system is malfunctioning.

When your vehicle is then towed away, significantly more effort may be required to steer and brake than is normally required.

- ▶ Use a tow bar.
- ▶ Make sure that the steering wheel can move freely, before towing the vehicle away.

! NOTE Damage due to excessive tractive power

If you pull away sharply, the tractive power may be too high and the vehicles could be damaged.

- ▶ Pull away slowly and smoothly.

Loading the vehicle for transport

- ▶ Observe the notes on towing away (→ page 276).
- ▶ Connect the tow bar to the towing eye to load the vehicle.
- ▶ **Vehicles with automatic transmission:** Shift the automatic transmission to position **P**.
- ⓘ **Vehicles with automatic transmission:** The automatic transmission may be locked in position **P** in the event of damage to the electrics. To shift to **N**, provide the on-board electrical system with power (→ page 272).

- ▶ Load the vehicle onto the transporter.
- ▶ **Vehicles with automatic transmission:** Shift the automatic transmission to position **P**.
- ▶ Use the electric parking brake to secure the vehicle and prevent it from rolling away.
- ▶ Only secure the vehicle by the wheels.

Vehicles with ADS PLUS (Adaptive Damping System PLUS)

⚠ WARNING Risk of accident when transporting vehicles with AIR BODY CONTROL

The reduced damping forces on the vehicle being transported can cause the vehicle/trailer combination to start to swing.

As a result, when transporting vehicles with AIR BODY CONTROL the vehicle/trailer combination may start to skid. Consequently, you could lose control of your vehicle.

There is a risk of accident and injury.

- ▶ Load the vehicle correctly onto the transporter.
- ▶ Secure the vehicle on all four wheels with suitable tensioning straps.
- ▶ Do not exceed the maximum permissible speed of 35 mph (60 km/h) when transporting.

! **NOTE** Damage to the vehicle from securing it incorrectly

- ▶ After loading, the vehicle must be secured at all four wheels. Otherwise, the vehicle could be damaged.
- ▶ A minimum distance of 8 in (20 cm) up and 4 in (10 cm) down must be kept to the transport platform.

- ▶ Secure the vehicle on all four wheels after loading.

4MATIC vehicles/vehicles with automatic transmission

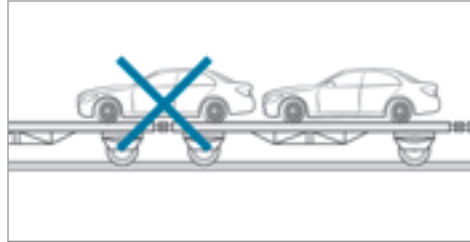

- ▶ Make sure that the front and rear axles come to rest on the same transport vehicle.

! **NOTE** Damage to the drivetrain due to incorrect positioning

- ▶ Do not position the vehicle above the connection point of the transport vehicle.

Towing eye storage location

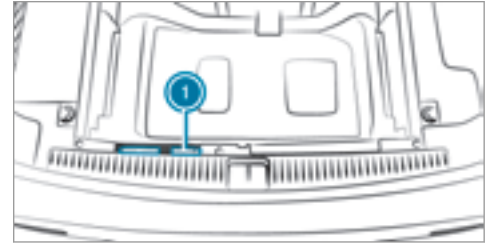

Towing eye ① is attached to the edge of the cargo compartment under the cargo compartment floor.

Vehicles with folding bench seat: The towing eye is located under a cover.

Installing the towing eye

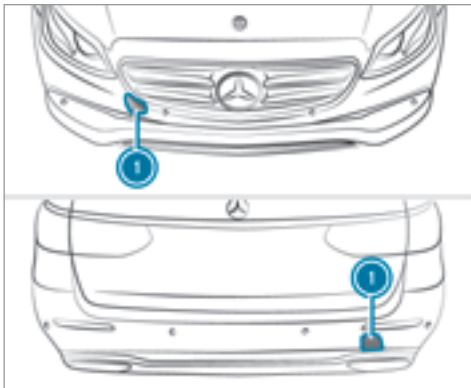

- ▶ Press the mark on cover ① inwards and remove.
- ▶ Screw in the towing eye clockwise to the stop.
- ① Make sure that cover ① engages in the bumper when you remove the towing eye.

! **NOTE** Damage due to incorrect use of the towing eye

When a towing eye is used to recover a vehicle, the vehicle may be damaged in the process.

- ▶ Only use the towing eye to tow away or tow start the vehicle.

Tow starting the vehicle (emergency engine start)

Vehicles with automatic transmission

! **NOTE** Damage to the automatic transmission due to tow starting

The automatic transmission may be damaged in the process of tow starting vehicles with automatic transmission.

- ▶ Vehicles with automatic transmission must not be tow started.

- ▶ Vehicles with automatic transmission must not be tow started.

Electrical fuses

Notes on electrical fuses

! **WARNING** Risk of accident and injury due to overloaded lines

If you manipulate or bridge a faulty fuse or if you replace it with a fuse with a higher amperage, the electric line could be overloaded.

This could result in a fire.

- ▶ Always replace faulty fuses with specified new fuses containing the correct amperage.

! **NOTE** Damage caused by incorrect fuses

Incorrect fuses may cause damage to electrical components or systems.

- ▶ Only use Mercedes-Benz approved fuses with the correct fuse rating.

Blown fuses must be replaced with fuses of the same rating, which you can recognize by the

color and fuse rating. The fuse ratings are listed in the fuse assignment diagram.

Fuse assignment diagram: on the fuse box in the cargo compartment (→ page 283).

! **NOTE** Damage or malfunctions caused by moisture

Moisture may cause damage to the electrical system or cause it to malfunction.

- ▶ When the fuse box is open, make sure that no moisture can enter the fuse box.
- ▶ When closing the fuse box, make sure that the seal of the lid is positioned correctly on the fuse box.

If a newly inserted fuse also blows, have the cause traced and rectified at a qualified specialist workshop.

Ensure the following before replacing a fuse:

- The vehicle is secured against rolling away.
- All electrical consumers are switched off.
- The ignition is switched off.

The electrical fuses are located in various fuse boxes:

- Fuse box in the engine compartment on the driver's side (→ page 281)
- Fuse box on the driver's side of the cockpit (→ page 282)
- Fuse box in the front-passenger footwell (→ page 282)
- Fuse box in the cargo compartment on the right-hand side of the vehicle, when viewed in the direction of travel (→ page 283)

Fuse box in the engine compartment

Prerequisites

Observe the notes on electrical fuses (→ page 280).

Have the following readily available:

- A dry cloth
- A screwdriver

Opening

! **WARNING** Risk of injury from using the windshield wipers while the engine hood is open

When the engine hood is open and the windshield wipers are set in motion, you can be trapped by the wiper linkage.

▶ Always switch off the windshield wipers and ignition before opening the engine hood.

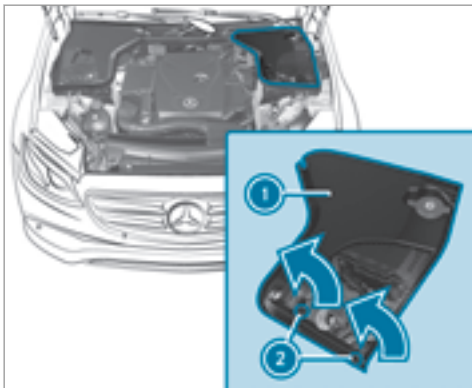

- ▶ Turn clip ② on cover ① a quarter-turn to the left.
- ▶ Pull cover ① upwards in the direction of the arrow.

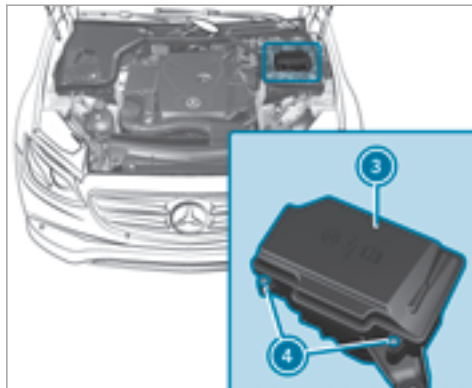

- ▶ Remove any existing moisture from the fuse box using a dry cloth.
- ▶ Loosen screws ④, remove fuse box lid ③ from the top.

Closing

- ▶ Check whether the seal is positioned correctly in the lid.

- ▶ Insert lid into the bracket at the rear of the fuse box.
- ▶ Fold down lid of the fuse box and tighten screws ④.
- ▶ Insert cover ① on both sides and engage safety clips.
- ▶ Close the hood.

Cockpit fuse box

The fuse box is on the side of the dashboard under a cover.

- ▶ Contact an authorized Mercedes-Benz Center for further information.

Fuse box in the front-passenger footwell

Prerequisites

Observe the notes on electrical fuses (→ page 280).

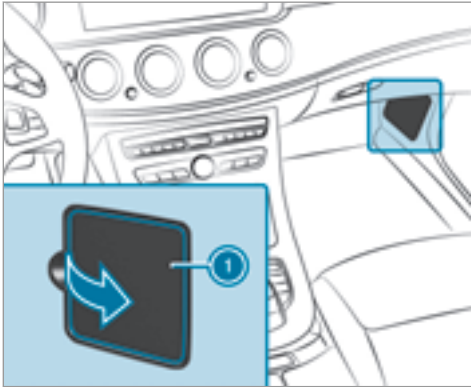

- ▶ Open cover ① in the direction of the arrow and remove it.

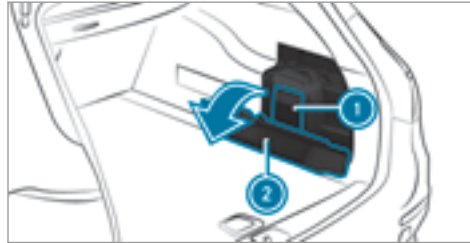

- ▶ Fold cover ② down in the direction of the arrow.
- ▶ Remove cover ①.

The fuse assignment diagram is in a recess on the side of the fuse box.

Fuse box in the cargo compartment

Requirements

Observe the notes on electrical fuses (→ page 280).

- ▶ Fold down the side cover.

Noise or unusual handling characteristics

While driving, pay attention to vibrations, noises and unusual handling characteristics, e.g. pulling to one side. This may indicate that the wheels or tires are damaged. If you suspect that a tire is defective, reduce your speed immediately. Stop the vehicle as soon as possible to check the wheels and tires for damage. Hidden tire damage could also be causing the unusual handling characteristics. If you find no signs of damage, have the tires and wheels checked at a qualified specialist workshop.

Regular checking of wheels and tires

⚠ WARNING Risk of accident from damaged tires

Damaged tires can cause tire pressure loss. As a result, you could lose control of your vehicle.

▶ Check the tires regularly for signs of damage and replace any damaged tires immediately.

⚠ WARNING Risk of aquaplaning due to insufficient tire tread

Insufficient tire tread will result in reduced tire grip. The tire tread is no longer able to dissipate water.

This means that in heavy rain or slush the risk of hydroplaning is increased, in particular if vehicle speed is not adapted to suit the conditions.

If the tire pressure is too high or too low, tires may exhibit different levels of wear at different locations on the tire contact surface.

▶ Thus, you should regularly check the tread depth and the condition of the tire contact surface across the entire width of all tires.

Minimum tread depth for:

- Summer tires: $\frac{1}{8}$ in (3 mm)
- M+S tires: $\frac{1}{6}$ in (4 mm)

▶ For safety reasons, replace the tires before the legally prescribed limit for the minimum tread depth is reached.

Carry out the following checks on all wheels regularly, at least once a month or as required, e.g. prior to a long journey or driving off-road:

- Check the tire pressure (→ page 285).
- Visual check of wheels and tires for damage.
- Check the valve caps.

The valves must be protected against moisture and dirt by the valve caps approved especially for your vehicle by Mercedes-Benz.

- Visual check of the tread depth and the tire contact surface across the entire width.

The minimum tread depth for summer tires is $\frac{1}{8}$ in (3 mm) and for winter tires $\frac{1}{6}$ in (4 mm).

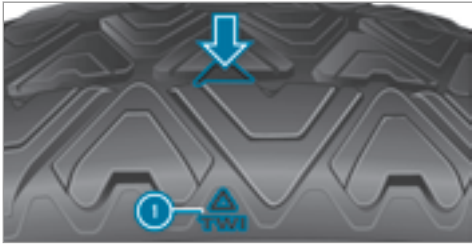

Six marks ① show where the bar indicators (arrow) are integrated into the tire tread. They are visible once a tread depth of approximately $\frac{1}{16}$ in (1.6 mm) has been reached.

Notes on snow chains

⚠ WARNING Risk of accident due to incorrect mounting of snow chains

If you have mounted snow chains to the front wheels, the snow chains may drag against the vehicle body or chassis components.

This could cause damage to the vehicle or the tires.

- ▶ Never mount snow chains on the front wheels.
- ▶ Only mount snow chains on the rear wheels in pairs.

! **NOTE** Damage to the wheel trim from mounted snow chains

If snow chains are mounted to steel wheels, the wheel trims can be damaged.

- ▶ Remove the wheel trims of steel wheels before mounting snow chains.

- Snow chains are only permissible for certain wheel/tire combinations. You can obtain information about this from an authorized Mercedes-Benz Center.
- For safety reasons, only use snow chains that have been specifically approved for your vehicle by Mercedes-Benz, or snow chains with the same quality standard.

- If snow chains are mounted, the maximum permissible speed is 30 mph (50 km/h).
 - **Vehicles with Parking Pilot:** Do not use Parking Assist PARKTRONIC if snow chains are mounted.
 - **Vehicles with AIR BODY CONTROL:** Only drive at raised vehicle level if snow chains are mounted.
- ① You can deactivate ESP® to pull away (→ page 159). This allows the wheels to spin, achieving an increased driving force.

Tire pressure

Notes on tire pressure

⚠ WARNING Risk of accident due to insufficient or excessive tire pressure

Underinflated or overinflated tires pose the following risks:

- The tires may burst, especially as the load and vehicle speed increase.

- The tires may wear excessively and/or unevenly, which may greatly impair tire traction.
 - The driving characteristics, as well as steering and braking, may be greatly impaired.
- ▶ Comply with the recommended tire pressure and check the tire pressure of all tires including the spare wheel regularly:
- at least once a month
 - when the load changes
 - before embarking on a longer journey
 - if operating conditions change, e.g. off-road driving
- ▶ Adjust the tire pressure as necessary.

Driving with tire pressure that is too high or too low can:

- Shorten the service life of the tires.
- Cause increased tire damage.

- Adversely affect handling characteristics and thus driving safety, e.g. due to hydroplaning.

⚠ WARNING Risk of an accident due to insufficient tire pressure

Tires with pressure that is too low can overheat and burst as a result.

In addition, they also suffer from excessive and/or irregular wear, which can significantly impair the braking properties and the handling characteristics.

- ▶ Avoid excessively low tire pressures in all the tires, including the spare wheel.

Tire pressure which is too low can cause:

- Tire defects as a result of overheating.
- Impaired handling characteristics
- Irregular wear
- Increased fuel consumption

⚠ WARNING Risk of accident from excessive tire pressure

Tires with excessively high pressure can burst because they are damaged more easily by highway fill, pot holes etc.

In addition, they also suffer from irregular wear, which can significantly impair the braking properties and the handling characteristics.

- ▶ Avoid excessively high tire pressures in all the tires, including the spare wheel.

Excessively high tire pressure can result in:

- Increased braking distance
- Impaired handling characteristics
- Irregular wear
- Impaired driving comfort
- Susceptibility to damage

⚠ WARNING Risk of accident caused by repeated drop in tire pressure

If the tire pressure drops repeatedly, the wheel, valve or tire may be damaged.

Insufficient tire pressure can cause the tires to burst.

- ▶ Inspect the tire for signs of foreign objects.
- ▶ Check whether the wheel or valve has a leak.
- ▶ If you are unable to rectify the damage, contact a qualified specialist workshop.

You can find information on tire pressure for the vehicle's factory-installed tires on the following labels:

- Tire and Loading Information placard on the B-pillar of your vehicle (→ page 291).
- Tire pressure table on the inside of the fuel filler flap (→ page 287).

Observe the maximum tire pressure (→ page 298).

Use a suitable pressure gauge to check the tire pressure. The outer appearance of a tire does not permit any reliable conclusion about the tire pressure.

Vehicles with a tire pressure monitoring system: You can also check the tire pressure using the on-board computer.

Only correct tire pressure when the tires are cold. Conditions for cold tires:

- The vehicle has been parked with the tires out of direct sunlight for at least three hours.
- The vehicle has traveled less than 1 mile (1.6 km).

A rise in the tire temperature of 18 °F (10 °C) increases the tire pressure by approx. 10 kPa (0.1 bar/1.5 psi). Take this into account when checking the tire pressure of warm tires.

The tire pressure recommended for increased load/speed in the tire pressure table can affect the ride comfort.

⚠ WARNING Risk of accident from unsuitable accessories on the tire valves

If you mount unsuitable accessories onto tire valves, the tire valves may be overloaded and malfunction, which can cause tire pressure loss. Tire pressure monitoring systems for retrofitting will cause the tire valve to remain open. This can also result in tire pressure loss.

- ▶ Only screw standard valve caps or valve caps specifically approved by Mercedes-Benz for your vehicle onto the tire valve.

Tire pressure table

The tire pressure table is on the inside of the fuel filler flap.

- ⓘ The data shown in the images is example data.

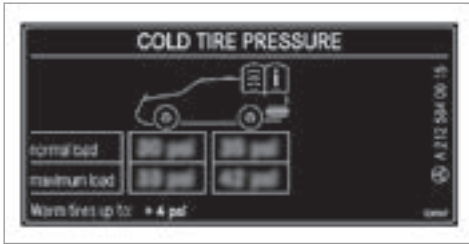

The tire pressure table shows the recommended tire pressure for all tires approved for this vehicle. The recommended tire pressures apply to cold tires under various operating conditions, i.e. loading and/or speed of the vehicle.

If one or more tire sizes precede a tire pressure, the tire pressure information following is only valid for those tire sizes.

The load conditions "partially laden" and "fully laden" are defined in the table for different numbers of passengers and amounts of luggage. The actual number of seats may differ from this.

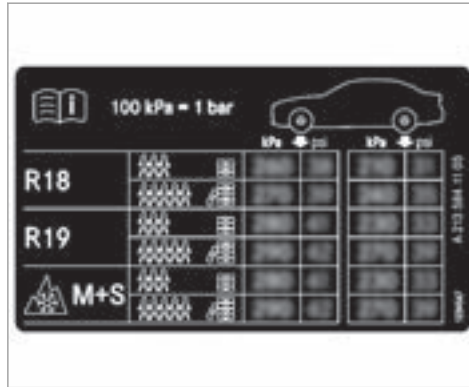

Some tire pressure tables only show the rim diameter instead of the complete tire size, e.g. **R18**. The rim diameter is part of the tire size and can be found on the tire side wall (→ page 299).

Be sure to also observe the following further related subjects:

- Notes on tire pressure (→ page 285)
- Tire and Loading Information placard (→ page 291)

- Maximum tire pressure (→ page 298)

Checking the tire pressure manually

- ▶ Read the tire pressure for the current operating conditions from the tire and loading information table or the tire pressure table. Observe the notes on tire pressure.
- ▶ Remove the valve cap of the tire to be checked.
- ▶ Press the tire pressure gauge securely onto the valve.
- ▶ Read the tire pressure.
- ▶ If the tire pressure is lower than the recommended value, increase the tire pressure to the recommended value.
- ▶ If the tire pressure is higher than the recommended value, release air. To do so, press down the metal pin in the valve, e.g. using the tip of a pen for example. Then check the tire pressure again using the tire pressure gauge.
- ▶ Screw the valve cap onto the valve.

Further related subjects:

- Notes on tire pressure (→ page 285)
- Tire pressure table (→ page 287)
- Tire and Loading Information placard (→ page 291)

Tire pressure monitoring system

Function of the tire pressure monitoring system

⚠ DANGER Risk of accident due to incorrect tire pressure

Every tire, including the spare (if provided), should be checked when cold at least once a month and inflated to the pressure recommended by the vehicle manufacturer (see Tire and Loading Information placard on the B-pillar on the driver's side or the tire pressure label on the inside of the fuel filler flap of your vehicle). If your vehicle has tires of a different size than the size indicated on the Tire and Loading Information placard or the

tire pressure table, you need to determine the proper tire pressure for those tires.

As an added safety feature, your vehicle has been equipped with a tire pressure monitoring system (TPMS) that illuminates a low tire pressure indicator lamp when one or more of your tires are significantly underinflated. Accordingly, if the low tire pressure indicator lamp lights up, you should stop and check your tires as soon as possible, and inflate them to the proper pressure. Driving on a significantly underinflated tire causes the tire to overheat and can lead to tire failure. Underinflation also increases fuel consumption and reduces tire tread life, and may affect the vehicle's handling and braking ability. Please note that the TPMS is not a substitute for proper tire maintenance, and it is the driver's responsibility to maintain correct tire pressure, even if underinflation has not reached the level to trigger illumination of the TPMS low tire pressure indicator lamp.

Your vehicle has also been equipped with a TPMS malfunction indicator to indicate when

the system is not operating properly. The TPMS malfunction indicator is combined with the low tire pressure indicator lamp. When the system detects a malfunction, the indicator lamp will flash for approximately a minute and then remain continuously illuminated. This sequence will continue upon subsequent vehicle start-ups as long as the malfunction exists.

When the malfunction indicator is illuminated, the system may not be able to detect or signal low tire pressure as intended. TPMS malfunctions may occur for a variety of reasons, including the installation of incompatible replacement or alternate tires or wheels on the vehicle that prevent the TPMS from functioning properly.

Always check the TPMS malfunction warning lamp after replacing one or more tires or wheels on your vehicle to ensure that the replacement or alternate tires and wheels allow the TPMS to continue to function properly.

The system checks the tire pressure of the tires installed on the vehicle by means of a tire pressure sensor.

New tire pressure sensor, e.g. in winter tires, are automatically taught-in the first time they are driven.

The tire pressure appears in the multifunction display (→ page 201).

If there is a substantial pressure loss or if the tire temperature is excessive, a warning will be given:

- Via display messages (→ page 354).
- Via the  warning lamp in the instrument cluster (→ page 384).

It is the driver's responsibility to set the tire pressure to the recommended cold tire pressure suitable for the operating situation. Set the tire pressure for cold tires using a tire pressure gauge. Note that the correct tire pressure for the current operating situation must first be taught-in to the tire pressure monitor.

In most cases, the tire pressure monitoring system will automatically update the new reference

values after you have changed the tire pressure. You can, however, also update the reference values by restarting the tire pressure monitoring system manually (→ page 291).

System limitations

The tire pressure monitoring system does not issue a warning:

- If the tire pressure is set incorrectly.
- If there is a sudden pressure loss caused, for example, by a foreign object penetrating the tire.
- If there is a malfunction caused by another radio signal source.

Be sure to also observe the following further related subjects:

- Notes on tire pressure (→ page 285)

Checking the tire pressure with the tire pressure monitoring system

Requirements

- The ignition is switched on.

On-board computer:

 [Service](#)  [Tire Pressure](#)

One of the following displays appears:

- Current tire pressure of each wheel:



- [Tire pressure will be displayed after driving a few minutes](#)
 - [Tire Pressure Monitor Active](#): the teach-in process of the system is not yet complete. The tire pressures are already being monitored.
-  Compare the tire pressure with the recommended tire pressure for the current operat-

ing condition (→ page 287). Observe the notes on tire temperature (→ page 285).

- ① The values displayed in the multifunction display may deviate from those of the tire pressure gauge as they refer to sea level. At high altitudes, the tire pressure values indicated by pressure gauges may be higher than those shown by the on-board computer. In this case, do not reduce the tire pressure.

Be sure to also observe the following further related subjects:

- Notes on tire pressure (→ page 285)

Restarting the tire pressure monitoring system

Requirements

- The recommended tire pressure is correctly set for the respective operating condition on each of the four wheels (→ page 285).

Restart the tire pressure monitoring system in the following situations:

- The tire pressure has changed.

- The wheels or tires have been changed or newly mounted.

On-board computer:

↪ **Service** ▶ **Tire Pressure**

▶ Swipe downwards on the Touch Control on the left-hand side of the steering wheel. The **Use Current Pressures as New Reference Values** message is shown in the multifunction display.

▶ Press **OK** to confirm the restart. The **Tire Press. Monitor Restarted** message is shown in the multifunction display.

Current warning messages are deleted and the **(!)** yellow warning lamp goes out.

After you have driven for a few minutes, the system checks whether the current tire pressures are within the specified range. The current tire pressures are then accepted as reference values and monitored.

Be sure to also observe the following further related subjects:

- Notes on tire pressure (→ page 285)

Radio-type approval of the tire pressure monitoring system

Radio equipment approval numbers

Country	Radio equipment approval number
Canada	FCC ID: MRXAG5SP4
USA	FCC ID: MRXMFR IC: 2546A-AG5SP4

Further information on the declaration of conformity for wireless vehicle components (→ page 19).

Loading the vehicle

Tire and Loading Information placard

⚠ WARNING Risk of accident from overloaded tires

Overloaded tires may overheat and burst as a consequence. Overloaded tires can also impair the steering and handling characteristics and lead to brake failure.

- ▶ Observe the load rating of the tires.
- ▶ The load rating must be at least half the permissible axle load of the vehicle.
- ▶ Never overload the tires by exceeding the maximum load.

The Tire and Loading Information placard is on the B-pillar on the driver's side of the vehicle.



1 Tire and Loading Information placard

TIRE AND LOADING INFORMATION RENSEIGNEMENTS SUR LES PNEUS ET LE CHARGEMENT			
SEATING CAPACITY NOMBRE DE PLACES	TOTAL #	FRONT AXLE #	REAR AXLE #
The combined weight of occupants and cargo should never exceed XXX kg or XXX lbs. Les poids totaux occupants et du chargement ne doit jamais dépasser XXX kg ou XXX lbs.			
TIRE PNEU	SIZE DIMENSIONS	COLD TIRE PRESSURE PRESSION DES PNEUS À FROID	SEE OWNER'S MANUAL FOR ADDITIONAL INFORMATION VOIR LE MANUEL DE L'USAGER POUR PLUS DE RENSEIGNEMENTS
FRONT AVANT	205/45 20R 85Y XL	200 kPa, 29 PSI	
REAR ARRIÈRE	205/45 20R 85Y XL	200 kPa, 29 PSI	
SPARE DE SECOURS	175/70 16R 85P	420 kPa, 60 PSI	

i The data shown in the image is example data.

The Tire and Loading Information placard shows:

- Maximum number of seats ② according to the maximum number of people permitted to travel in the vehicle
- Maximum permissible load ③ comprises the gross weight of all vehicle occupants, load and luggage.

- Recommended tire pressure ① for cold tires. The recommended tire pressures are valid for the maximum permissible load and up to the maximum permissible vehicle speed.

Please also note:

- Information on permissible weights and loads on the vehicle identification plate .
- Information on tire pressure in the tire pressure table (→ page 287).

Further related subjects:

- Determining the maximum permissible load (→ page 292)
- Notes on tire pressure (→ page 285)

Determining the maximum permissible load

The following steps have been developed as required of all manufacturers under Title 49, Code of U.S. Federal Regulations, Part 575, pursuant to the "National Traffic and Motor Vehicle Safety Act of 1966".

- ▶ **Step 1:** Locate the statement "The combined weight of occupants and cargo should never exceed XXX kg or XXX lbs." ("The combined weight of occupants and cargo should never exceed XXX kg or XXX lbs.") on your vehicle's tire and loading information table.
- ▶ **Step 2:** Determine the combined weight of the driver and passengers that will be riding in your vehicle.
- ▶ **Step 3:** Subtract the combined weight of the driver and passengers from XXX kg or XXX lbs.
- ▶ **Step 4:** The resulting figure equals the permissible load for cargo and luggage. For example: If "XXX" equals 1400 lbs and there are five occupants in your vehicle with a weight of 150 lbs each, the maximum cargo and luggage load capacity is 650 lbs (1400 - 750 (5 x 150) = 650 lbs).
- ▶ **Step 5:** Determine the combined weight of luggage and cargo being carried in the vehicle. For safety reasons, this weight may not safely exceed the available cargo and luggage load capacity calculated in step 4.

Even if you have calculated the total load carefully, you should still make sure that the maximum permissible gross mass and the maximum permissible axle load of your vehicle are not exceeded. Details can be found on the vehicle identification plate.

- ▶ Have your loaded vehicle – including driver, occupants and load – weighed on a vehicle weighbridge. The measured values may not exceed the maximum permissible values stated on the vehicle identification plate.

Further related subjects:

- Calculation example for determining the maximum load (→ page 293)
- Tire and Loading Information placard (→ page 291)
- Tire pressure table (→ page 287)
- Vehicle identification plate

Calculation example for determining the maximum load

The following table shows examples of how to calculate total and load capacities with varying seating configurations and different numbers and sizes of occupants. The following examples use a maximum load of 1500 lbs (680 kg). **This is for illustration purposes only.** Make sure you are using the actual load limit for your vehicle stated on your vehicle's Tire and Loading Information placard (→ page 291).

The higher the weight of all the occupants, the smaller the maximum load for luggage.

Step 1

	Example 1	Example 2
Combined maximum weight of occupants and cargo (data from the Tire and Loading Information placard)	1500 lbs (680 kg)	1500 lbs (680 kg)

Step 2

	Example 1	Example 2
Number of people in the vehicle (driver and occupants)	5	1
Distribution of the occupants	Front: 2 Rear: 3	Front: 1
Weight of occupants	Occupant 1: 150 lbs (68 kg) Occupant 2: 180 lbs (82 kg) Occupant 3: 160 lbs (73 kg) Occupant 4: 140 lbs (63 kg) Occupant 5: 120 lbs (54 kg)	Occupant 1: 200 lbs (91 kg)
Total weight of all occupants	750 lbs (340 kg)	200 lbs (91 kg)

Step 3

	Example 1	Example 2
Permissible load (maximum gross vehicle weight rating from the Tire and Loading Information placard minus the gross weight of all occupants)	1500 lbs (680 kg) - 750 lbs (340 kg) = 750 lbs (340 kg)	1500 lbs (680 kg) - 200 lbs (91 kg) = 1300 lbs (589 kg)

Tire labeling

Overview of tire labeling

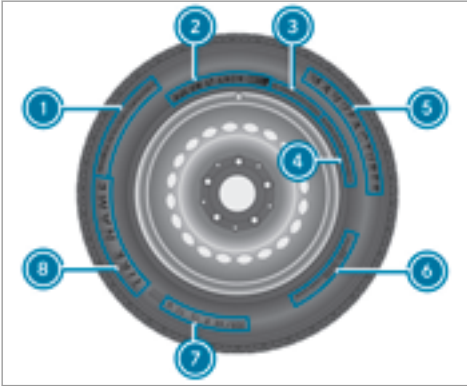

- ① Uniform Tire Quality Grading Standard (→ page 296)
- ② DOT (Department of Transportation), (TIN) Tire Identification Number (→ page 297)
- ③ Maximum tire load (→ page 298)
- ④ Maximum tire pressure (→ page 298)

- ⑤ Manufacturer
- ⑥ Tire characteristics (→ page 299)
- ⑦ Tire size designation, load rating, speed rating and load index (→ page 299)
- ⑧ Tire name
- ① The data shown in the image is example data.

Tire Quality Grading

In accordance with the US Department of Transportation's "Uniform Tire Quality Grading Standards", tire manufacturers are required to grade their tires on the basis of the following three performance factors:

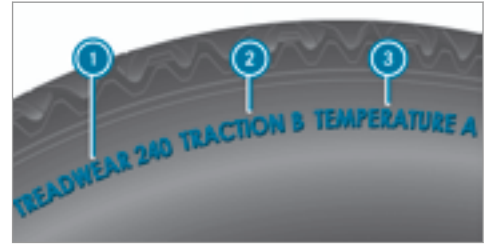

- ① Tread wear grade
- ② Traction grade
- ③ Temperature grade
- ① The data shown in the image is example data.
- ① The classification is not legally stipulated for Canada, but it is generally stated.

Tread wear grade

The tread wear grade is a comparative rating based on the wear rate of the tire when tested under controlled conditions on a specified test track of the US Department of Transportation. For example, a tire graded 150 would wear one

and one-half times as well on the government course as a tire graded 100.

The relative performance of tires depends upon the actual conditions of their use, however, and may depart significantly from the norm due to variations in driving habits, service practices and differences in road characteristics and climate conditions.

Traction grade

⚠ DANGER Risk of accident due to inadequate traction

The traction grade assigned to this tire is based on straight-ahead braking traction tests, and does not include either acceleration, cornering, hydroplaning or peak traction characteristics.

- ▶ Always adapt your driving style and drive at a speed to suit the prevailing traffic and weather conditions.

! **NOTE** Damage to the drivetrain from wheelspin

- ▶ Avoid wheelspin.

The traction grades – from highest to lowest – are AA, A, B and C. Those grades represent the tire's ability to stop on wet pavement as measured under controlled conditions on specified government test surfaces made of asphalt and concrete.

Temperature grade

⚠ WARNING Risk of accident from tire overheating and tire failure

The temperature grade for this tire is established for a tire that is properly inflated and not overloaded. Excessive speed, underinflation, or excessive loading, either separately or in combination, can cause excessive heat build-up and possible tire failure.

- ▶ Observe the recommended tire pressures and regularly check the tire pres-

sure of all tires including the spare wheel.

- ▶ Adjust the tire pressure as necessary.

The temperature grades are A (the highest), B and C. They represent the tire's resistance to the generation of heat and its ability to dissipate heat when tested under controlled conditions on a specified indoor laboratory test wheel. Sustained high temperatures can cause the material of the tire to degenerate and reduce tire life. Furthermore, excessive temperatures can lead to sudden tire failure. Grade C corresponds to a level of performance which all passenger car tires must meet under the requirements of the US Department of Transportation.

DOT, Tire Identification Number (TIN)

US tire regulations stipulate that every tire manufacturer or retreader must imprint a TIN in or on the side wall of each tire produced.



i The data shown in the image is example data.

The TIN is a unique identification number to identify tires and comprises the following:

- **DOT (Department of Transportation):** tire symbol marks **1** indicating that the tire complies with the requirements of the US Department of Transportation.
- **Manufacturer identification code:** manufacturer identification code **2** contains details of the tire manufacturer. New tires have a code with two symbols. Retreaded tire have a code with four symbols. Further information on retreaded tires (→ page 304).

- **Tire size:** identifier **3** describes the tire size.
- **Tire type code:** tire type code **4** can be used by the manufacturer as a code to describe specific characteristics of the tire.
- **Manufacturing date:** manufacturing date **5** provides information about the age of a tire. The 1st and 2nd positions represent the calendar week and the 3rd and 4th positions state the year of manufacture (e.g. "3208" represents the 32nd week of 2008).

Information on the maximum tire load



i The data shown in the image is example data.

Maximum tire load **1** is the maximum permissible weight for which the tire is approved.

Do not overload the tires by exceeding the specified load limit. The maximum permissible load can be found on the vehicle's Tire and Loading Information placard on the B-pillar on the driver's side (→ page 291).

Specifications for maximum tire pressure



i The data shown in the image is example data.

Never exceed maximum tire pressure ❶ specified for the tire.

Information on tire characteristics



❶ The data shown in the image is example data.

This information describes the type of tire cord and the number of layers in side wall ❶ and under tire tread ❷.

Tire size designation, load-bearing capacity, speed rating and load index

⚠ WARNING Risk of injury through exceeding the specified tire load rating or the permissible speed rating

Exceeding the specified tire load rating or the permissible speed rating may lead to tire damage and to the tires bursting.

- ▶ Therefore, only use tire types and sizes approved for your vehicle model.
- ▶ Observe the tire load rating and speed rating required for your vehicle.



- ❶ Preceding letter
- ❷ Nominal tire width in millimeters
- ❸ Aspect ratio in %
- ❹ Tire code
- ❺ Rim diameter
- ❻ Load-bearing index
- ❼ Speed rating
- ❽ Load index

❶ The data shown in the image is example data.

Information on reading tire data can be obtained from any qualified specialist workshop.

Preceding letter 1:

- Without: passenger vehicle tires according to European manufacturing standards.
- "P": passenger vehicle tires according to US manufacturing standards.
- "LT": light truck tires according to US manufacturing standards.
- "T": compact emergency spare wheels with high tire pressure that are only designed for temporary use in an emergency.

Aspect ratio 3:

Ratio between tire height and tire width in percent (tire height divided by tire width).

Tire code 4 (tire type):

- "R" radial tires
- "D": diagonal or bias-ply tires
- "B": diagonal radial tires or bias belted tires
- "ZR": radial tires with a maximum speed above 149 mph (240 km/h) (optional)

Rim diameter 5:

The diameter of the bead seat (not the diameter of the rim flange). The rim diameter is specified in inches (in).

Load-bearing index 6

Numerical code that specifies the maximum load-bearing capacity of a tire (for example, "91" corresponds to 1356 lbs (615 kg)).

The load-bearing capacity of the tire must be at least half the permissible gross axle load of your vehicle. Do not overload the tires by exceeding the specified load limit.

See also:

- Maximum permissible load on the Tire and Loading Information placard (→ page 291)
- Maximum tire load (→ page 298)
- Load index

Speed rating 7:

Specifies the approved maximum speed of the tire.

- **i** An electronic speed limiter prevents your vehicle from exceeding a speed of 130 mph (210 km/h).

Make sure that your tires have the required speed rating. You can obtain information on the required speed rating from an authorized Mercedes-Benz Center.

Summer tires

Index	Speed rating
Q	up to 100 mph (160 km/h)
R	up to 106 mph (170 km/h)
S	up to 112 mph (180 km/h)
T	up to 118 mph (190 km/h)
H	up to 130 mph (210 km/h)
V	up to 149 mph (240 km/h)
W	up to 168 mph (270 km/h)
Y	up to 186 mph (300 km/h)

Index	Speed rating
ZR...Y ¹	up to 186 mph (300 km/h)
ZR...(..Y) ¹	over 186 mph (300 km/h)
ZR ¹	over 149 mph (240 km/h)

- Specifying the speed rating as the "ZR" index in tire code ④ is optional for tires up to 186 mph (300 km/h).
- If your tire code ④ includes "ZR" and there is no speed rating ⑦, find out what the maximum speed is from the tire manufacturer.
- If load-bearing index ⑥ and speed rating ⑦ are in brackets, the maximum speed rating of your tire is above 186 mph (300 km/h). To find out the maximum speed, ask the tire manufacturer.

All-weather tires and winter tires

Index	Speed rating
Q M+S ²	up to 100 mph (160 km/h)
T M+S ²	up to 118 mph (190 km/h)
H M+S ²	up to 130 mph (210 km/h)
V M+S ²	up to 149 mph (240 km/h)

Winter tires bear the  snowflake symbol and fulfill the requirements of the Rubber Manufacturers Association (RMA) and the Rubber Association of Canada (RAC) regarding the tire traction on snow.

Load index ⑧:

- No specification given: standard load (SL) tire
- "XL" or "Extra Load": extra load tire or reinforced tire
- "Light Load": light load tire

- "C", "D", "E": a load range that depends on the maximum load that the tire can carry at a certain pressure

Definitions for tires and loading

Tire structure and characteristics: describes the number of layers or the number of rubber-coated belts in the tire contact surface and the tire wall. These are made of steel, nylon, polyester and other materials.

Bar: metric unit for tire pressure. 14.5038 pounds per square inch (psi) and 100 kilopascal (kPa) is the equivalent of one bar.

DOT (Department of Transportation): DOT marked tires fulfill the requirements of the US Department of Transportation.

Average weight of the vehicle occupants: the number of vehicle occupants for which the vehicle is designed, multiplied by 150 lb (68 kg).

¹ "ZR" stated in the tire code.

² Or "M+S  " for winter tires

Uniform Tire Quality Grading Standards: a uniform standard to grade the quality of tires with regard to tread quality, tire traction and temperature characteristics. The quality grading assessment is made by the manufacturer following specifications from the U.S. government. The quality grade of a tire is imprinted on the side wall of the tire.

Recommended tire pressure: the recommended tire pressure is the tire pressure specified for the tires mounted to the vehicle at the factory.

The tire and information table contains the recommended tire pressure for cold tires, the maximum permissible load and the maximum permissible vehicle speed.

The tire pressure table contains the recommended tire pressure for cold tires under various operating conditions, i.e. loading and/or speed of the vehicle.

Increased vehicle weight due to optional equipment: the combined weight of all standard and optional equipment available for the vehicle,

regardless of whether it is actually installed on the vehicle or not.

Rim: the part of the wheel on which the tire is mounted.

GAWR (Gross Axle Weight Rating): the GAWR is the maximum gross axle load. The actual load on an axle must never exceed the gross axle weight rating. The gross axle weight rating can be found on the vehicle identification plate on the B-pillar on the driver's side.

Speed rating: the speed rating is part of the tire identification. It specifies the speed range for which a tire is approved.

GVW (Gross Vehicle Weight): the gross vehicle weight comprises the weight of the vehicle including fuel, tools, the spare wheel, accessories installed, occupants, luggage and the trailer drawbar noseweight, if applicable. The gross vehicle weight must not exceed the gross vehicle weight rating GVWR as specified on the vehicle identification plate on the B-pillar on the driver's side.

GVWR (Gross Vehicle Weight Rating): the GVWR is the maximum permitted gross weight

of the fully laden vehicle (weight of the vehicle including all accessories, occupants, fuel, luggage and the trailer drawbar noseweight if applicable). The gross vehicle weight rating is specified on the vehicle identification plate on the B-pillar on the driver's side.

Maximum weight of the laden vehicle: the maximum weight is the sum of the unladen weight of the vehicle, the weight of the accessories, the maximum load and the weight of optional equipment installed at the factory.

Kilopascal (kPa): metric unit for tire pressure. 6.9 kPa corresponds to 1 psi. Another unit for tire pressure is bar. 100 kilopascal (kPa) equals 1 bar.

Load index: in addition to the load-bearing index, the load index may also be imprinted on the side wall of the tire. This specifies the load-bearing capacity of the tire more precisely.

Curb weight: the weight of a vehicle with standard equipment including the maximum capacity of fuel, oil and coolant. It also includes the air conditioning system and optional equipment if

these are installed on the vehicle, but does not include passengers or luggage.

Maximum tire load: the maximum tire load is the maximum permissible weight in kilograms or lbs for which a tire is approved.

Maximum permissible tire pressure: maximum permissible tire pressure for one tire.

Maximum load on one tire: maximum load on one tire. This is calculated by dividing the maximum axle load of one axle by two.

PSI (pounds per square inch): standard unit of measurement for tire pressure.

Aspect ratio: ratio between tire height and tire width in percent.

Tire pressure: pressure inside the tire applying an outward force to every square inch of the tire. The tire pressure is specified in pounds per square inch (psi), in kilopascals (kPa) or in bar. The tire pressure should only be corrected when the tires are cold.

Cold tire pressure: the tires are cold when the vehicle has been parked for at least 3 hours

without direct sunlight on the tires or the vehicle has been driven for less than 1 mile (1.6 km).

Tire contact surface: the part of the tire that comes into contact with the road.

Tire bead: the purpose of the tire bead is to ensure that the tire sits securely on the wheel rim. There are several steel wires in the bead to prevent the tire from coming loose from the wheel rim.

Side wall: the part of the tire between the tread and the tire bead.

Weight of optional equipment: the combined weight of the optional equipment weighing more than the replaced standard parts and more than 5 lbs (2.3 kg). This optional equipment, such as high-performance brakes, level control system, a roof luggage rack or high-performance batteries, is not included in the curb weight and the weight of the accessories.

TIN (Tire Identification Number): a unique identification number which can be used by a tire manufacturer to identify tires, for example, in a product recall, and thus identify the purchasers. The TIN is made up of the manufactur-

er's identity code, tire size, tire type code and the manufacturing date.

Load-bearing index: the load-bearing index (also load index) is a code that contains the maximum load-bearing capacity of a tire.

Traction: traction is the grip resulting from friction between the tires and the road surface.

Wear indicator: narrow bars (tread wear bars) that are distributed over the tire contact surface. If the tire tread is level with the bars, the wear limit of 1/16 in (1.6 mm) has been reached.

Distribution of vehicle occupants: distribution of vehicle occupants over designated seat positions in a vehicle.

Maximum permissible payload weight: nominal load and luggage load plus 150 lb (68 kg) multiplied by the number of seats in the vehicle.

Changing a wheel

Notes on selecting, mounting and replacing tires

You can ask for information regarding permitted wheel/tire combinations at an authorized Mercedes-Benz Center.

⚠ WARNING Risk of accident due to incorrect dimensions of wheels and tires

If wheels and tires of the wrong size are installed, the wheel brakes or wheel suspension components may be damaged.

▶ Always replace wheels and tires with those that fulfill the specifications of the original part.

When replacing wheels, make sure to fit the correct:

- Designation
- Model

When replacing tires, make sure to install the correct:

- Designation
- Manufacturer
- Model

⚠ WARNING Risk of injury through exceeding the specified tire load rating or the permissible speed rating

Exceeding the specified tire load rating or the permissible speed rating may lead to tire damage and to the tires bursting.

- ▶ Therefore, only use tire types and sizes approved for your vehicle model.
- ▶ Observe the tire load rating and speed rating required for your vehicle.

! NOTE Damage to vehicle and tires due to non-approved tire types and sizes

For safety reasons, only use wheels, tires and accessories which have been approved for your vehicle by Mercedes-Benz.

These tires have been specially adapted for use with the control systems, e.g. ABS or ESP®, and are marked as follows:

- MO = Mercedes-Benz Original
- MOE = Mercedes-Benz Original Extended (run-flat tires only for certain wheels)
- MO1 = Mercedes-Benz Original (only certain AMG tires)

Certain characteristics, e.g. handling, vehicle noise emissions or fuel consumption, may otherwise be adversely affected. In addition, when driving with a load, tire dimension variations could cause the tires to come into contact with the body and axle components. This could result in damage to the tires or the vehicle.

Only use tires, wheels or accessories tested and approved by Mercedes-Benz.

! **NOTE** Risk to driving safety from retreaded tires

Retreaded tires are neither tested nor recommended by Mercedes-Benz, since previous damage cannot always be detected on retreaded tires.

For this reason driving safety cannot be guaranteed.

▶ Do not use used tires if you have no information about their previous usage.

! **NOTE** Possible damage to wheels or tires when driving over obstacles

Large wheels have a lower tire section width. The lower the tire section width, the greater is the risk of damage to wheels or tires when driving over obstacles.

▶ Avoid obstacles or drive particularly carefully.

! **NOTE** Damage to electronic component parts from the use of tire-mounting tools

Vehicles with a tire pressure monitoring system: Electronic component parts are located in the wheel. Tire-mounting tools should not be used in the area of the valve.

This could otherwise damage the electronic component parts.

▶ Have the tires changed at a qualified specialist workshop only.

! **NOTE** Damage to summer tires at low ambient temperatures

Using summer tires at very low ambient temperatures can cause cracks to form, thereby damaging the tires permanently.

▶ At temperatures below 45 °F (7 °C) use M+S tires.

Accessory parts that are not approved for your vehicle by Mercedes-Benz or that are not being used correctly can impair operating safety.

Before purchasing and using non-approved accessories, visit a qualified specialist workshop and inquire about:

- Suitability
- Legal stipulations
- Factory recommendations

! **WARNING** Risk of accident with high performance tires

The special tire tread in combination with the optimized tire compound means that the risk of skidding or hydroplaning on wet roads is increased.

In addition, the tire grip is greatly reduced at a low outside temperature and tire running temperature.

- ▶ Switch on the ESP® and adapt your driving style accordingly.
- ▶ Use M+S tire at outside temperatures of less than 10 °C (50 °F).

Observe the following when selecting, mounting and replacing tires:

- Only use tires and wheels of the same type (summer tires, winter tires, MOExtended tires) and the same make.
- Only mount wheels of the same size on one axle (left and right).
It is only permissible to deviate from this rule in the event of a flat tire in order to drive to the specialist workshop.
- Only mount tires of the correct size onto the wheels.
- **Vehicles with a tire pressure monitoring system:** All mounted wheels must be equipped with functioning sensors for the tire pressure monitoring system.
- At temperatures below 45 °F (7 °C), use winter tires or all-season tires marked M+S for all wheels.

Winter tires bearing the  snowflake symbol in addition to the M+S marking provide the best possible grip in wintry road conditions.

- For M+S tire, only use tires with the same tread.
- Observe the maximum permissible speed for the M+S tire mounted.
If this is below the vehicle's maximum speed, this must be indicated in an appropriate label in the driver's field of vision.
- Break in new tires at moderate speeds for the first 60 miles (100 km).
- Replace the tires after six years at the latest, regardless of wear.
- **When replacing with tires that do not feature run-flat characteristics:** Vehicles with MOExtended tires are not equipped with a TIREFIT kit at the factory. Equip the vehicle with a TIREFIT kit after replacing with tires that do not feature run-flat characteristics, for example winter tires.

For more information on wheels and tires, contact a qualified specialist workshop.

Be sure to also observe the following further related subjects:

- Notes on tire pressure (→ page 285)

- Tire and Loading Information placard (→ page 291)
- Tire size designation, load-bearing capacity, speed rating and load index (→ page 299)
- Tire pressure table (→ page 287)

Notes on interchanging wheels

 **WARNING** Risk of injury through different wheel sizes

Interchanging the front and rear wheels if the wheels or tires have different dimensions may severely impair the driving characteristics.

The wheel brakes or wheel suspension components may also be damaged.

 Rotate front and rear wheels only if the wheels and tires are of the same dimensions.

The wear patterns on the front and rear wheels differ:

- Front wheels wear more on the shoulder of the tire
- Rear wheels wear more in the center of the tire

On vehicles that have the same size front and rear wheels, interchange the wheels according to the intervals in the tire manufacturer's warranty book in your vehicle documents. If this is not available, interchange the tires every 3,000 to 6,000 miles (5,000 to 10,000 km), depending on the wear. Ensure that the direction of rotation is maintained.

It is imperative to observe the instructions and safety notes on "Wheel change" when doing so.

Notes on storing wheels

- After removing wheels, store them in a cool, dry and preferably dark place.
- Protect the tires from contact with oil, grease or fuel.

Overview of the tire-change tool kit

Apart from some country-specific variants, vehicles are not equipped with a tire-change tool kit. For more information on which tire-changing tools are required and approved for performing a wheel change on your vehicle, consult a qualified specialist workshop.

Necessary tire-changing tools may include, for example:

- Jack
- Chock
- Wheel wrench
- Centering pin

The tire-change tool kit is in tool bag ① under the cargo compartment floor.

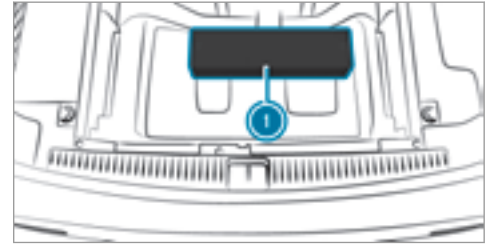

① Tool bag

Tool bag ① contains:

- Jack
- Gloves
- Wheel wrench
- Centering pin
- Folding wheel chock
- Ratchet for jack

Setting up the folding wheel chock

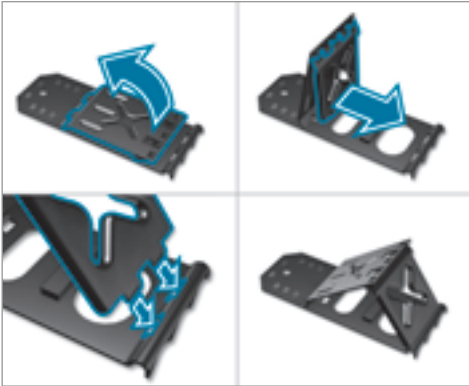

Preparing the vehicle for a wheel change

Requirements

- The required tire-change tool kit is available. If your vehicle is not equipped with the tire-change tool kit, consult a qualified specialist workshop to find out about suitable tools.

- The vehicle is not on a slope.
 - The vehicle is on solid, non-slippery and level ground.
- ▶ Apply the electric parking brake manually.
 - ▶ Bring the front wheels into the straight-ahead position.
 - ▶ **Vehicles with automatic transmission:** Shift into position **P**.
 - ▶ **Vehicles with AIR BODY CONTROL:** Set the normal vehicle level (→ page 176).
 - ▶ Switch off the engine.
 - ▶ Make sure that the engine cannot be started.
 - ▶ Place chocks or other suitable items under the front and rear of the wheel that is diagonally opposite the wheel you wish to change.
 - ▶ Remove the hub caps if necessary (→ page 308).
 - ▶ Raise the vehicle (→ page 309).

Removing and mounting hub caps

Requirements

- ▶ The vehicle is prepared for a wheel change (→ page 308).

Plastic hub cap

- ▶ **To remove:** turn the center cover of the hub cap counter-clockwise and remove the hub cap.
- ▶ **To mount:** make sure that the center cover of the hub cap is turned counter-clockwise.
- ▶ Position the hub cap and turn the center cover clockwise until the hub cap engages physically and audibly.

Aluminum hub cap

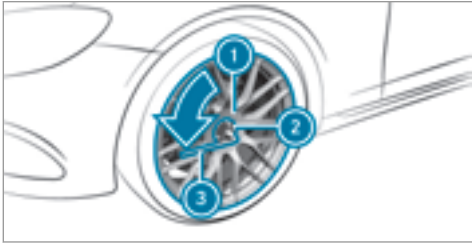

▶ **To remove:** position socket ② on hub cap ①.

① The socket can be found in the tire-change tool kit.

▶ Position wheel wrench ③ on socket ②.

▶ Using wheel wrench ③, turn hub cap ① counter-clockwise and remove it.

▶ **To mount:** position hub cap ① and turn until it is completely flush with the wheel.

▶ Position socket ② on hub cap ①.

▶ Attach wheel wrench ③ to socket ② and tighten the hub cap clockwise.

Specified tightening torque: 18 lb-ft (25 Nm).

▶ Raise the vehicle (→ page 309).

Raising the vehicle when changing a wheel

Requirements

- There are no persons in the vehicle.
- The vehicle is prepared for a wheel change (→ page 308).
- The hub caps have been removed (→ page 308).

Important notes on using the jack:

- Only use the vehicle-specific jack that has been tested and approved by Mercedes-Benz to raise the vehicle.
- The jack is only designed for raising and holding the vehicle for a short time while a wheel is being changed and not for maintenance work under the vehicle.

- The jack must be placed on a firm, flat and non-slip surface. If necessary, use a large, load-bearing, non-slip underlay.
- The base of the jack must be positioned vertically under the jack support point.

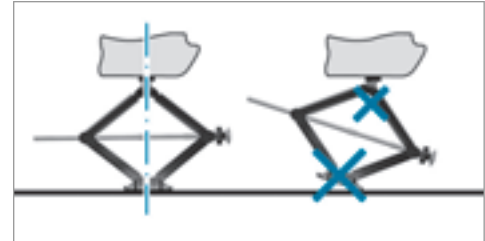

Rules of conduct when the vehicle is raised:

- Never place your hands or feet under the vehicle.
- Do not lie under the vehicle.
- Do not start the engine and do not release the parking brake.
- Do not open or close any doors or the tailgate.



- ▶ Using the wheel wrench, loosen the wheel bolts on the wheel you wish to change by about one full turn. Do not unscrew the screws completely.

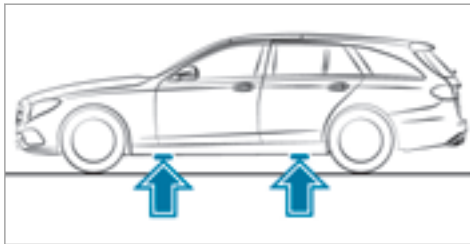

Position of jack support points

⚠ WARNING Risk of injury from incorrect positioning of the jack

If you do not position the jack correctly at the appropriate jacking point of the vehicle, the jack could tip with the vehicle raised.

- ▶ Only position the jack at the appropriate jacking point of the vehicle. The base of the jack must be positioned vertically under the jacking point of the vehicle.

! **NOTE** Vehicle damage from the jack

If you do not position the jack correctly at the appropriate jack support point of the vehicle, the jack could tip over with the vehicle raised.

- ▶ The jack is designed exclusively for jacking up the vehicle at the jack support points.

- ▶ Take the ratchet wrench out of the tire-change tool kit and place it on the hexagon nut of the jack so that the letters AUF are visible.

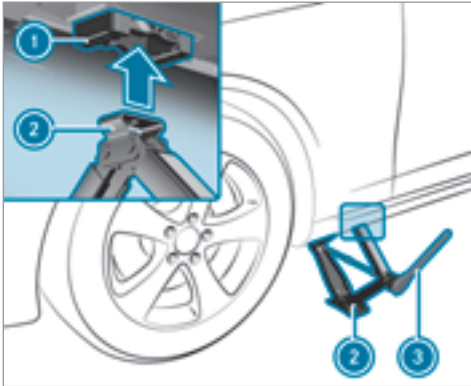

- ▶ Position jack ② at jack support point ①.
- ▶ Turn ratchet wrench ③ clockwise until jack ② sits completely on jack support point ① and the base of the jack lies evenly on the ground.
- ▶ Continue to turn ratchet wrench ③ until the tire is raised a maximum of 1.2 in (3 cm) off the ground.
- ▶ Loosen and remove the wheel (→ page 311).

Removing a wheel

Requirements

- The vehicle is raised (→ page 309).

When changing a wheel, avoid applying any force to the brake discs, since this could impair the level of comfort when braking.

! **NOTE** Damage to threading from dirt on wheel bolts

▶ Do not place wheel bolts in sand or on a dirty surface.

▶ Unscrew the uppermost wheel bolt completely.

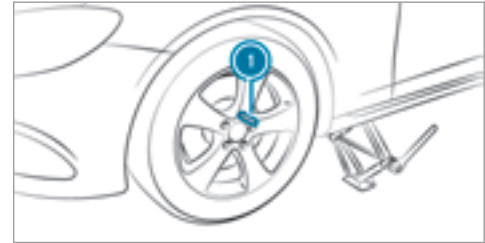

- ▶ Screw centering pin ① instead of the wheel bolt into the thread.
- ▶ Unscrew the remaining wheel bolts fully.
- ▶ Remove the wheel.
- ▶ Mount the new wheel (→ page 311).

Mounting a new wheel

Requirements

- The wheel is removed (→ page 311).

⚠ WARNING Risk of accident from losing a wheel

Oiled, greased or damaged wheel bolt/wheel nut threads or wheel hub/wheel mounting bolt threads can cause the wheel bolts/wheel nuts to come loose.

As a result, you could lose a wheel while driving.

- ▶ Never oil or grease the threads.
- ▶ In the event of damage to the threads, contact a qualified specialist workshop immediately.
- ▶ Have the damaged wheel bolts or damaged hub threads replaced.
- ▶ Do not continue driving.

- ▶ Observe the information on the choice of tires (→ page 304).

For tires with a specified direction of rotation, an arrow on the side wall of the tire indicates the correct direction of rotation. Observe the direction of rotation when mounting.

- ▶ Slide the wheel to be mounted onto the centering pin and push it on.

⚠ WARNING Risk of injury from tightening wheel bolts and nuts

If you tighten the wheel bolts or wheel nuts when the vehicle is raised, the jack could tip.

- ▶ Only tighten wheel bolts or wheel nuts when the vehicle is on the ground.

- ▶ For safety reasons, Mercedes-Benz recommends that you only use wheel bolts which have been approved for Mercedes-Benz vehicles, as well as for the wheel in question.

! NOTE Damage to paintwork of the wheel rim when screwing on the first wheel bolt

If the wheel has too much play when screwing in the first wheel bolt, the wheel rim paint can be damaged.

- ▶ Press the wheel firmly against the wheel hub when screwing on the first wheel bolt.

- ▶ Tighten the wheel bolts until they are finger-tight.
- ▶ Unscrew the centering pin.
- ▶ Tighten the last wheel bolt until it is finger-tight.
- ▶ Lower the vehicle(→ page 312).

Lowering the vehicle after a wheel change

Requirements

- The new wheel has been mounted (→ page 311).
- ▶ Place the ratchet wrench onto the hexagon nut of the jack so that the letters "AB" are visible.
- ▶ **To lower the vehicle:** turn the ratchet wrench of the jack counter-clockwise.

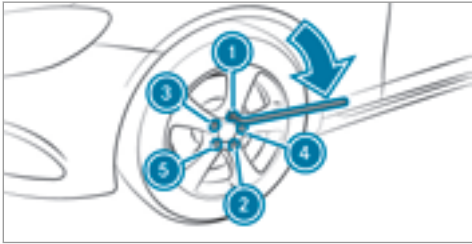

- ▶ Tighten the wheel bolts evenly in a crosswise pattern in the sequence indicated (① to ⑤). **Specified tightening torque:** 111 lb-ft (150 Nm).

⚠ WARNING Risk of accident due to incorrect tightening torque

The wheels could come loose if the wheel bolts or wheel nuts are not tightened to the prescribed tightening torque.

- ▶ Have the tightening torque checked immediately at a qualified specialist workshop after changing a wheel.

- ▶ Check the tire pressure of the newly mounted wheel and adjust accordingly.
- ▶ **Vehicles with a tire pressure monitoring system:** restart the tire pressure monitoring system (→ page 291).

Be sure to also observe the following further related subjects:

- Notes on tire pressure (→ page 285)

Notes on technical data

The data stated only applies to vehicles with standard equipment. You can obtain further information from an authorized Mercedes-Benz Center.

Vehicle electronics

Two-way radios

Notes on installing two-way radios

⚠ WARNING Risk of accident from incorrectly carried out work on the RF transmitter

The electromagnetic radiation from RF transmitters can interfere with the vehicle electronics if RF transmitters are manipulated or retrofitted incorrectly.

This could jeopardize the operating safety of the vehicle.

- ▶ You should have all work on electrical and electronic components carried out at a qualified specialist workshop.

⚠ WARNING Risk of accident from incorrect operation of the RF transmitter

If you operate RF transmitters incorrectly in the vehicle, the electromagnetic radiation could interfere with the on-board electronics, e.g.:

- if the RF transmitter is not connected to an exterior antenna
- if the exterior antenna is not correctly mounted or is not a low-reflection type.

This could jeopardize the operating safety of the vehicle.

- ▶ Have the low-reflection exterior antenna installed at a qualified specialist workshop.
- ▶ When operating RF transmitters in the vehicle, always connect them to the low-reflection exterior antenna.

❗ NOTE Invalidation of the operating permit due to failure to comply with the instructions for installation and use

The operating permit may be invalidated if the instructions for installation and use of RF transmitters are not observed.

- ▶ Only use approved frequency bands.
- ▶ Observe the maximum permissible output power in these frequency bands.
- ▶ Only use approved antenna positions.

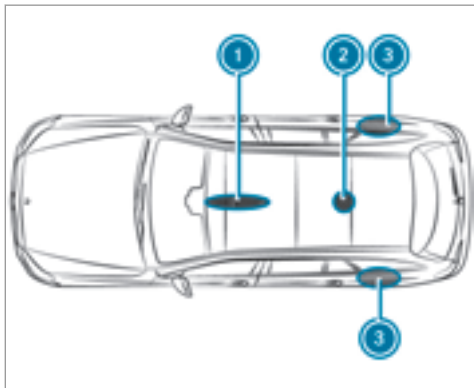

- ① Front roof area
- ② Rear roof area
- ③ Rear fender

On vehicles with a panoramic sliding sunroof, installing an antenna on the front or rear roof area is not permitted.

On the rear fenders, it is recommended that you position the antenna on the side of the vehicle closest to the center of the road.

Use Technical Specification ISO/TS 21609 (Road Vehicles – EMC guidelines for installation of aftermarket radio frequency transmitting equipment) when retrofitting RF (radio frequency) transmitters. Comply with the legal requirements for detachable parts.

If your vehicle has installations for two-way radio equipment, use the power supply or antenna connections intended for use with the basic wiring. Be sure to observe the manufacturer's supplements when installing.

Two-way radio transmission output

The maximum transmission output (PEAK) at the base of the antenna must not exceed the values in the following table:

Frequency band and maximum transmission output

Frequency band	Maximum transmission output
Short wave 3 - 54 MHz	100 W
4 m band 74 - 88 MHz	30 W
2 m band 144 - 174 MHz	50 W
Trunked radio system/Tetra 380 - 460 MHz	10 W
70 cm band 420 - 450 MHz	35 W
Mobile communications (2G/3G/4G)	10 W

The following can be used in the vehicle without restrictions:

- RF transmitter with a maximum transmission output of up to 100 mW
- RF transmitters with transmitter frequencies in the 380 - 410 MHz frequency band and a maximum transmission output of up to 2 W (trunked radio system/Tetra)
- Mobile phones (2G/3G/4G)

There are no restrictions when positioning the antenna on the outside of the vehicle for the following frequency bands:

- Trunked radio system/Tetra
- 70 cm band
- 2G/3G/4G

Vehicle identification plate, VIN and engine number

Vehicle identification plate

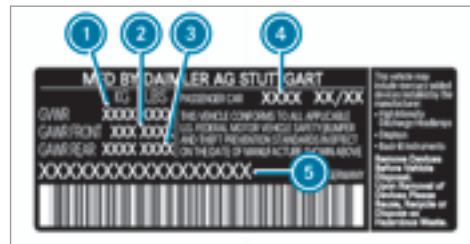
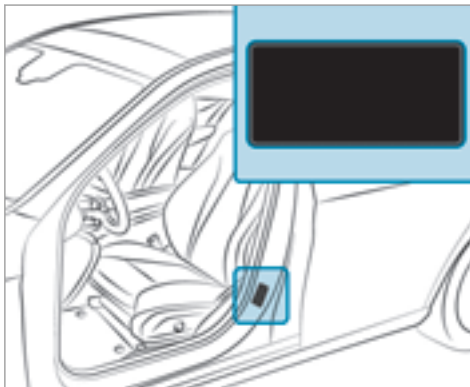

Vehicle identification plate (USA only)

- 1 Permissible gross mass
- 2 Permissible front axle load
- 3 Permissible rear axle load
- 4 Paint code
- 5 VIN (vehicle identification number)

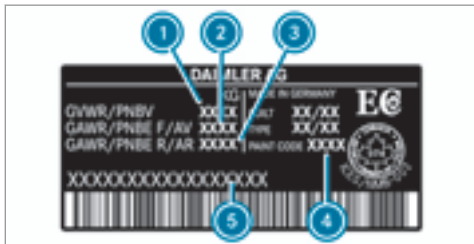

Vehicle identification plate (Canada only)

- ① Permissible gross mass
- ② Permissible front axle load
- ③ Permissible rear axle load
- ④ Paint code
- ⑤ VIN (vehicle identification number)

The maximum permissible gross vehicle weight is made up of the vehicle weight, all vehicle occupants, the fuel and the load. The maximum permissible axle load is the maximum weight that can be carried by one axle (front or rear axle).

Never exceed the permissible gross vehicle weight or the maximum permissible axle load for the front or rear axle.

VIN in front of the right-hand front seat

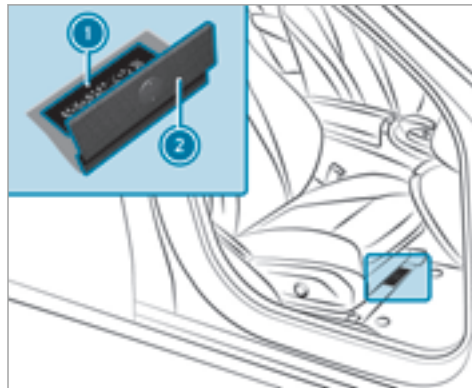

- ① VIN (vehicle identification number)
- ② Floor covering

Additional plates

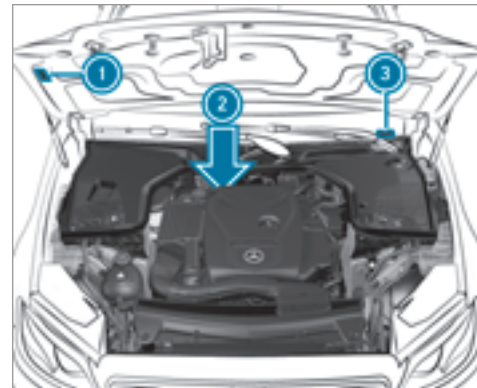

- ① Plate with information about emissions testing, including confirmation of emissions guidelines at the U.S. federal level as well as for California
- ② Engine number stamped into the crankcase
- ③ VIN (vehicle identification number)

Operating fluids

Notes on operating fluids

⚠ WARNING Risk of injury from operating fluids harmful to your health

Operating fluids may be poisonous and harmful to your health.

- ▶ Observe the text on the original containers when using, storing or disposing of operating fluids.
- ▶ Always store operating fluids sealed in their original containers.
- ▶ Always keep children away from operating fluids.

🌿 ENVIRONMENTAL NOTE Environmental pollution caused by environmentally irresponsible disposal

- ▶ Dispose of operating fluids in an environmentally responsible manner.

Operating fluids include the following:

- Fuels
- Lubricants
- Coolant
- Brake fluid
- Windshield washer fluid
- Climate control system refrigerant

Only use products recommended by Mercedes-Benz. Damage caused by using vehicle products which have not been recommended is not covered by the Mercedes-Benz guarantee, warranty or goodwill gestures.

You can identify operating fluids approved by Mercedes-Benz by the following inscription on the containers:

- MB-Freigabe (e.g. MB-Freigabe 229.51)
- MB-Approval (e.g. MB-Approval 229.51)

Further information on approved operating fluids:

- In the Mercedes-Benz Specifications for operating fluids at <http://bevo.mercedes-benz.com> (by entering the designation)
- At a qualified specialist workshop

⚠ WARNING Risk of fire and explosion caused by fuel

Fuels are highly inflammable.

- ▶ You must avoid fire, open flames, creating sparks and smoking.
- ▶ Before refueling, switch off the engine and, if installed in your vehicle, the stationary heater.

⚠ WARNING Risk of injury from fuel

Fuels are poisonous and harmful to your health

- ▶ Do not swallow fuel or let it come into contact with skin, eyes or clothing.
- ▶ Do not inhale fuel vapors.

- ▶ Keep children away from fuel.

If you or other people come into contact with fuel, observe the following:

- ▶ Immediately rinse fuel off your skin with soap and water.
- ▶ If fuel comes into contact with your eyes, immediately rinse them thoroughly with clean water. Seek medical attention immediately.
- ▶ If you swallow fuel, seek medical attention immediately. Do not induce vomiting.
- ▶ Change immediately out of clothing that has come into contact with fuel.

Fuel

Information on fuel grades for vehicles with a gasoline engine

Observe the notes on operating fluids (→ page 318).

! NOTE Damage caused by the wrong fuel

Even small amounts of the wrong fuel could result in damage to the fuel system, the engine and the emission control system.

- ▶ Only refuel with low-sulfur premium grade fuel.

This fuel may contain up to 10 % ethanol. Your vehicle is suitable for use with E10 fuel.

Do not refuel using:

- Diesel
- E15, E85, E100
- Gasoline containing methanol (M15, M30, M85, M100)
- Gasoline with additives containing metal

If you accidentally refuel with the wrong fuel:

- ▶ Do not switch the ignition on.
- ▶ Consult a qualified specialist workshop.

If the available fuel is not sufficiently low in sulfur, this can produce unpleasant odors.

Only refuel with fuel, that has at least the octane number specified in the information table in the fuel filler flap (→ page 145). This may reduce engine output and increase fuel consumption.

If you want maximum engine output: only refuel with unleaded premium grade gasoline with an octane number of at least 91 AKI/95 RON.

Never refuel using gasoline with a lower RON.

! NOTE Premature wear caused by unleaded regular gasoline

Unleaded regular gasoline can cause the engine to wear more quickly and impair longevity and performance.

If unleaded premium grade gasoline is unavailable and you have to refuel using unleaded regular gasoline:

- ▶ Only fill the fuel tank to half full with unleaded regular gasoline and refill as soon as possible with unleaded premium grade gasoline.
- ▶ Do not drive at the maximum speed.

- ▶ Avoid sudden acceleration and engine speeds over 3,000 rpm.

Further information on fuel can be found:

- At a gas station
- At a qualified specialist workshop
- **USA only:** Under <http://www.mbusa.com>

Information on additives in gasoline

Observe the notes on operating fluids (→ page 318).

- !** **NOTE** Damage caused by non-approved additives

Even small amounts of the wrong additive may lead to malfunctions occurring.

- ▶ Only add cleaning additives recommended by Mercedes-Benz to the fuel.

Mercedes-Benz recommends that you use fuel brands that have additives.

The fuel grade available in some countries may not be sufficient. Residue could build up in the fuel injection system as a result. In this case, in

consultation with an authorized Mercedes-Benz Center, the fuel may be mixed with the cleaning additive recommended by Mercedes-Benz. Always observe the notes and mixing ratios specified on the container.

Notes on fuel consumption

-  **ENVIRONMENTAL NOTE** Increased CO₂ emissions caused by increased fuel consumption

The CO₂ emissions of your vehicle depend directly on the fuel consumption.

- ▶ You can minimize CO₂ emissions by driving carefully and having your vehicle serviced regularly.

Tank capacity and reserve fuel level

Capacity

Model	Total capacity
All models	17.4 US gal (66.0 l) or 21.1 US gal (80.0 l)
Model	Of which reserve
All models	1.8 US gal (7.0 l)

Engine oil

Notes on engine oil

Observe the notes on operating fluids (→ page 318).



! **NOTE** Engine damage caused by an incorrect oil filter, incorrect oil or additives

- ▶ Do not use engine oils or oil filters other than those which meet the specifications necessary for the prescribed service intervals.
- ▶ Do not alter the engine oil or oil filter in order to achieve longer change intervals than prescribed.
- ▶ Do not use additives.
- ▶ Have the engine oil changed after the prescribed intervals.

Mercedes-Benz recommends that you have the oil change carried out at a qualified specialist workshop.

Further information on engine oils and oil filters:

- In the Mercedes-Benz Specifications for Operating Fluids at <http://bevo.mercedes-benz.com> (by entering the designation)
- At a qualified specialist workshop

Quality and filling capacity of engine oil

MB-Freigabe or MB-Approval

Gasoline engines	MB-Freigabe or MB-Approval
All models	229.5, 229.6

The following values refer to an oil change, including the oil filter:

Capacity

Model	Capacity
All models	6.9 US qt (6.5 l)

Notes on brake fluid

Observe the notes on operating fluids (→ page 318).

! **WARNING** Risk of an accident due to vapor pockets forming in the brake system

The brake fluid constantly absorbs moisture from the air. This lowers the boiling point of the brake fluid. If the boiling point is too low, vapor pockets may form in the brake system when the brakes are applied hard.

This causes the braking effect to be impaired.

- ▶ Have the brake fluid renewed at the specified intervals.

Have the brake fluid regularly changed at a qualified specialist workshop.

Only use brake fluid approved by Mercedes-Benz according to MB-Freigabe or MB-Approval 331.0.

Further information on brake fluid:

- In the Mercedes-Benz Specifications for Operating Fluids at <http://bevo.mercedes-benz.com>
- At a qualified specialist workshop

Coolant

Notes on coolant

Observe the notes on operating fluids (→ page 318).

⚠ WARNING - Risk of fire and injury from antifreeze

If antifreeze comes into contact with hot component parts in the engine compartment, it may ignite.

- ▶ Allow the engine to cool down before adding antifreeze.
- ▶ Make sure that no antifreeze spills out next to the filler opening.

▶ Thoroughly clean off any antifreeze from component parts before starting the vehicle.

! NOTE Damage caused by incorrect coolant

▶ Only add coolant that has been pre-mixed with the required antifreeze protection.

Further information on coolant:

- In the Mercedes-Benz Specifications for Operating Fluids 310.1, e.g. online at <http://bevo.mercedes-benz.com>.
- At a qualified specialist workshop.

! NOTE Overheating at high outside temperatures

If an inappropriate coolant is used, the engine cooling system is not sufficiently protected against overheating and corrosion at high outside temperatures.

▶ Always use an appropriate coolant.

Have the coolant regularly changed at a qualified specialist workshop.

The proportion of corrosion inhibitor/ antifreeze concentrate in the engine cooling system should be:

- A minimum of 50% (antifreeze protection down to approximately -35 °F (-37 °C)).
- A maximum of 55% (antifreeze protection down to -49 °F (-45 °C)).

Coolant filling capacity

Filling capacity

Model	Filling capacity
All models	12.7 US qt (12.0 l)

Notes on windshield washer fluid

Observe the notes on operating fluids (→ page 318).

⚠ WARNING - Risk of fire and injury from windshield washer concentrate

Windshield washer concentrate is highly flammable. It could ignite if it comes into contact with hot engine component parts or the exhaust system.

- ▶ Make sure that no windshield washer concentrate spills out next to the filler opening.

! NOTE Damage to the exterior lighting due to unsuitable windshield washer fluid

Unsuitable windshield washer fluid may damage the plastic surface of the exterior lighting.

- ▶ Only use windshield washer fluid which is also suitable for use on plastic surfaces, e.g. MB SummerFit or MB WinterFit.

! NOTE Blocked spray nozzles caused by mixing windshield washer fluids

- ▶ Do not mix MB SummerFit and MB WinterFit with other windshield washer fluids.

Do not use distilled or de-ionized water as the fill level sensor may be triggered erroneously.

Recommended windshield washer fluid:

- Above freezing point: e.g. MB SummerFit
- Below freezing point: e.g. MB WinterFit

For the correct mixing ratio refer to the information on the antifreeze reservoir.

Add windshield washer fluid to the washer water all year round.

Refrigerant

Notes on refrigerants

Observe the notes on operating fluids (→ page 318).

! NOTE Damage due to incorrect refrigerant

If a non-approved refrigerant is used, the climate control system may be damaged.

- ▶ Only use the refrigerant R-134a

! NOTE Damage to the climate control system due to incorrect refrigerant compressor oil

- ▶ Only use refrigerant compressor oil that has been approved by Mercedes-Benz.
- ▶ Do not mix the approved refrigerant compressor oil with a different refrigerant compressor oil.

Work on the climate control system may only be carried out by a qualified specialist workshop. All applicable regulations, as well as SAE standard J639, must be adhered to.



- ① Warning symbols
- ② Refrigerant filling capacity
- ③ Applicable standards
- ④ PAG oil part number
- ⑤ Refrigerant type

Warning symbols ① advise you about:

- Possible dangers
- Having service work carried out at a qualified specialist workshop

Refrigerant filling capacity

Filling capacity for refrigerant and PAG oil

Model	Refrigerant
All models	22.2 ± 0.4 oz (630 ± 10 g)
Model	PAG oil
All models	2.8 ± 0.4 oz (80 ± 10 g)

Vehicle data

Vehicle dimensions

The heights specified may vary as a result of the:

- Tires
- Load
- Condition of the suspension
- Optional equipment

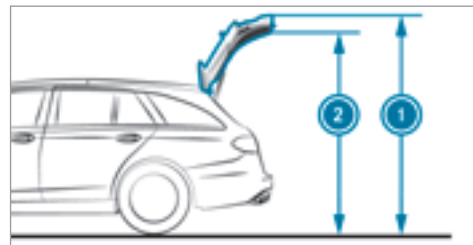

Opening height

Model	① Opening height	② Head-room
All models	81.8 in (2077 mm)	76.8 in (1951 mm)

Vehicle dimensions

All models	
Vehicle length	194.2 in (4933 mm)
Vehicle width including outside mirrors	81.3 in (2065 mm)
Vehicle height	58.4 in (1483 mm)
Wheelbase	115.7 in (2939 mm)
Turning circle	39.0 ft (11.90 m)

Roof load

All models	
Maximum roof load	220 lb (100 kg)

Weights and loads

Please note that for the specified vehicle data:

- items of optional equipment increase the curb weight and reduce the maximum payload.

Display messages

Introduction

Notes on display messages

Display messages appear in the multifunction display.

Display messages with graphic symbols are simplified in the Operator's Manual and may differ from the symbols in the multifunction display. The multifunction display shows high-priority display messages in red. Certain display messages are accompanied by a warning tone.

Please respond in accordance with the display messages and follow the additional notes in this Operator's Manual.

You can hide low-priority display messages by pressing the  button or the left-hand Touch Control. The display messages are then stored in the message memory. Rectify the cause of a display message as quickly as possible.

High-priority display messages cannot be hidden. The multifunction display shows these display messages continuously until the cause for the display message has been rectified.

Calling up stored display messages

On-board computer:

 [Service](#)  [1 Message](#)

If there are no display messages, [No Messages](#) appears in the multifunction display.

- ▶ Scroll through the display messages by swiping upwards or downwards on Touch Control on the left-hand side of the steering wheel.
- ▶ **To exit the message memory:** press the  button.

Safety systems

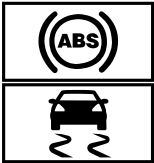
Display messages	Possible causes/consequences and ► Solutions
 <p data-bbox="118 456 445 519">Currently Unavailable See Operator's Manual</p>	<p data-bbox="527 236 1406 311">* ABS and ESP® are temporarily unavailable. Other driving and driving safety systems may also be malfunctioning.</p> <div data-bbox="553 335 1984 387" style="background-color: #e0e0e0; padding: 5px;"> <p data-bbox="574 346 1416 377">▲ WARNING Risk of skidding if ABS and ESP® are malfunctioning</p> </div> <p data-bbox="574 397 1909 459">If ABS and ESP® are malfunctioning, the wheels could lock when braking and ESP® cannot carry out vehicle stabilization.</p> <p data-bbox="574 474 1954 539">The steering capability and braking characteristics are thus severely impaired. The braking distance in an emergency braking situation can increase. In addition, other driving safety systems are switched off.</p> <ul data-bbox="574 553 1565 625" style="list-style-type: none"> <li data-bbox="574 553 844 584">► Drive on carefully. <li data-bbox="574 594 1565 625">► Have ABS and ESP® checked immediately at a qualified specialist workshop. <ul data-bbox="553 660 1964 768" style="list-style-type: none"> <li data-bbox="553 660 1892 726">► Carefully drive on a suitable stretch of road, making slight steering movements at a speed above 19 mph (30 km/h). <li data-bbox="553 736 1964 768">► If the display message does not disappear, consult a qualified specialist workshop immediately. Drive carefully.

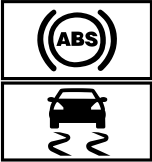
Display messages	Possible causes/consequences and ► Solutions
 <p data-bbox="57 408 392 464">Inoperative See Operator's Manual</p>	<p data-bbox="466 187 1344 262">* ABS and ESP[®] are malfunctioning. Other driving and driving safety systems may also be malfunctioning.</p> <div data-bbox="492 285 1919 591" style="border: 1px solid gray; padding: 5px;"><p data-bbox="517 296 1351 329">▲ WARNING Risk of skidding if ABS and ESP[®] are malfunctioning</p><p data-bbox="517 350 1845 412">If ABS and ESP[®] are malfunctioning, the wheels could lock when braking and ESP[®] cannot carry out vehicle stabilization.</p><p data-bbox="517 427 1892 490">The steering capability and braking characteristics are thus severely impaired. The braking distance in an emergency braking situation can increase. In addition, other driving safety systems are switched off.</p><ul data-bbox="517 505 1500 578" style="list-style-type: none"><li data-bbox="517 505 778 531">▶ Drive on carefully.<li data-bbox="517 547 1500 578">▶ Have ABS and ESP[®] checked immediately at a qualified specialist workshop.</div> <ul data-bbox="492 614 1181 685" style="list-style-type: none"><li data-bbox="492 614 758 640">▶ Drive on carefully.<li data-bbox="492 655 1181 685">▶ Consult a qualified specialist workshop immediately.

Display messages	Possible causes/consequences and ► Solutions
 <p data-bbox="122 303 445 362">Currently Unavailable See Operator's Manual</p>	<p data-bbox="527 187 952 218">* ESP® is temporarily unavailable.</p> <p data-bbox="553 232 1404 263">Other driving and driving safety systems may also be malfunctioning.</p> <div data-bbox="553 283 1984 339"><p data-bbox="578 296 1283 329">▲ WARNING Risk of skidding if ESP® is malfunctioning</p></div> <p data-bbox="574 350 1937 412">If ESP® is malfunctioning, ESP® cannot carry out vehicle stabilization. In addition, other driving safety systems are switched off.</p> <ul data-bbox="574 427 1293 503" style="list-style-type: none"><li data-bbox="574 427 842 458">▶ Drive on carefully.<li data-bbox="574 469 1293 503">▶ Have ESP® checked at a qualified specialist workshop. <p data-bbox="553 536 1892 601">▶ Carefully drive on a suitable stretch of road, making slight steering movements at a speed above 19 mph (30 km/h).</p> <p data-bbox="553 614 1964 645">▶ If the display message does not disappear, consult a qualified specialist workshop immediately. Drive carefully.</p>

Display messages



Inoperative See Operator's Manual

Possible causes/consequences and ► Solutions

* ESP® is malfunctioning.

Other driving and driving safety systems may also be malfunctioning.

The brake system continues to operate normally. The braking distance may increase in an emergency braking situation.

▲ WARNING Risk of skidding if ESP® is malfunctioning

If ESP® is malfunctioning, ESP® cannot carry out vehicle stabilization. In addition, other driving safety systems are switched off.







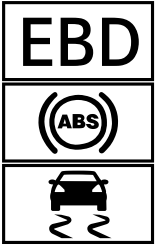

► Drive on carefully.

► Have ESP® checked at a qualified specialist workshop.

► Drive on carefully.

► Consult a qualified specialist workshop immediately.

Display messages	Possible causes/consequences and ► Solutions
 <p data-bbox="118 513 457 570">Inoperative See Operator's Manual</p>	<p data-bbox="527 184 1406 260">* EBD, ABS and ESP® are malfunctioning. Other driving and driving safety systems may also be malfunctioning.</p> <div data-bbox="553 283 1984 339"><p data-bbox="578 296 1483 329">▲ WARNING Risk of skidding if EBD, ABS and ESP® are malfunctioning</p></div> <p data-bbox="574 350 1954 412">If EBD, ABS and ESP® are malfunctioning, the wheels can lock when braking and ESP® cannot carry out vehicle stabilization.</p> <p data-bbox="574 427 1954 490">The steering capability and braking characteristics are thus severely impaired. The braking distance in an emergency braking situation can increase. In addition, other driving safety systems are switched off.</p> <ul data-bbox="574 505 1600 578" style="list-style-type: none"><li data-bbox="574 505 844 531">▶ Drive on carefully.<li data-bbox="574 547 1600 578">▶ Have the brake system checked immediately at a qualified specialist workshop. <ul data-bbox="553 612 1248 684" style="list-style-type: none"><li data-bbox="553 612 823 638">▶ Drive on carefully.<li data-bbox="553 653 1248 684">▶ Consult a qualified specialist workshop immediately.

Display messages	Possible causes/consequences and ► Solutions
 <p>(USA only)</p>  <p>(Canada only)</p> <p>Turn On the Ignition to Release the Parking Brake</p>	<p>* The red  (USA only) or  (Canada only) indicator lamp is lit. You have attempted to release the electric parking brake with the ignition switched off.</p> <p>► Switch the ignition on.</p>
 <p>(USA only)</p>  <p>(Canada only)</p> <p>Please Release Parking Brake</p>	<p>* The red  (USA only) or  (Canada only) indicator lamp flashes. The electric parking brake is applied while driving:</p> <ul style="list-style-type: none">• A condition for automatic release of the electric parking brake is not fulfilled .• You are performing emergency braking using the electric parking brake . <p>► Check that the conditions for automatic release of the electric parking brake are fulfilled.</p> <p>► Release the electric parking brake manually.</p>

Display messages



(USA only)



(Canada only)

Parking Brake See Operator's Manual

Possible causes/consequences and ► Solutions



* The yellow  indicator lamp is lit. The electric parking brake is malfunctioning.

To apply:

- Switch off the ignition and turn it back on.
- Apply the electric parking brake manually .

If it is not possible to engage the electric parking brake:

- Consult a qualified specialist workshop.
- Where necessary, also safeguard the parked vehicle against rolling away.

The yellow  and the red  (USA only) or  (Canada only) indicator lamps are lit. The electric parking brake is malfunctioning.

To release:



- Switch off the ignition and turn it back on.
- Release the electric parking brake manually .

or





- Release the electric parking brake automatically .

If it is still not possible to release the electric parking brake:

- Do not continue driving under any circumstances. Consult a qualified specialist workshop.

The yellow  indicator lamp is lit and the red  (USA only) or  (Canada only) indicator lamp is flashing. The electric parking brake is malfunctioning.

The electric parking brake could not be applied or released.



Display messages	Possible causes/consequences and ► Solutions
	<ul style="list-style-type: none">► Switch off the ignition and turn it back on. <p>To apply:</p> <ul style="list-style-type: none">► Release and then apply the electric parking brake manually . <p>To release:</p> <ul style="list-style-type: none">► Apply and then release the electric parking brake manually. <p>If the electric parking brake cannot be applied or the red  (USA only) or  (Canada only) indicator lamp continues to flash:</p> <ul style="list-style-type: none">► Do not continue driving under any circumstances. Consult a qualified specialist workshop.► Where necessary, also safeguard the parked vehicle against rolling away. <p>The yellow indicator lamp  is on and the red  indicator lamp (USA only) or  (Canada only) indicator lamp flashes for approximately ten seconds after the electric parking brake has been applied or released. It then remains lit or goes out. The electric parking brake is malfunctioning.</p> <p>If the battery charge level is too low:</p> <ul style="list-style-type: none">► Charge the battery. <p>To apply:</p> <ul style="list-style-type: none">► Switch the ignition off. The electric parking brake is applied automatically.





Display messages	Possible causes/consequences and ► Solutions
	<p>If you do not wish the electric parking brake to be applied, leave the ignition switched on, e.g. when washing the vehicle in an automatic car wash or when having the vehicle towed away. This is not necessary when towing the vehicle away with the rear axle raised.</p> <p>If the electric parking brake is not applied automatically:</p> <ul style="list-style-type: none">► Switch off the ignition and turn it back on.► Release and then apply the electric parking brake manually . <p>If it is still not possible to apply the electric parking brake:</p> <ul style="list-style-type: none">► Consult a qualified specialist workshop.► Where necessary, also safeguard the parked vehicle against rolling away. <p>To release:</p> <ul style="list-style-type: none">► If the conditions for automatic release are fulfilled and the electric parking brake is not released automatically, release the electric parking brake manually . <p>If it is still not possible to release the electric parking brake:</p> <ul style="list-style-type: none">► Do not continue driving under any circumstances. Consult a qualified specialist workshop.

Display messages	Possible causes/consequences and ► Solutions
<div data-bbox="69 187 263 291" data-label="Image"> </div> <p data-bbox="57 301 190 329">(USA only)</p> <div data-bbox="69 346 263 449" data-label="Image"> </div> <p data-bbox="57 459 226 487">(Canada only)</p> <p data-bbox="57 501 355 529">Check Brake Fluid Level</p>	<p data-bbox="466 185 1214 213">* There is not enough brake fluid in the brake fluid reservoir.</p> <div data-bbox="492 236 1919 493" data-label="Complex-Block" style="border: 1px solid gray; padding: 5px;"> <p data-bbox="517 249 1283 277">▲ WARNING Risk of an accident due to low brake fluid level</p> <p data-bbox="517 298 1749 326">If the brake fluid level is too low, the braking effect and the braking characteristics may be impaired.</p> <ul style="list-style-type: none"> <li data-bbox="517 342 1837 401">► Pull over and stop the vehicle safely as soon as possible, paying attention to road and traffic conditions. Do not continue driving under any circumstances. <li data-bbox="517 418 1046 477">► Consult a qualified specialist workshop. Do not add brake fluid. </div> <ul style="list-style-type: none"> <li data-bbox="492 515 1909 574">► Pull over and stop the vehicle safely as soon as possible, paying attention to road and traffic conditions. Do not continue driving under any circumstances. <li data-bbox="492 591 1024 650">► Consult a qualified specialist workshop. Do not add brake fluid.
<div data-bbox="69 672 263 775" data-label="Image"> </div> <p data-bbox="57 786 343 814">Check Brake Pad Wear</p>	<p data-bbox="466 670 1075 698">* The brake linings have reached their wear limit.</p> <ul style="list-style-type: none"> <li data-bbox="492 714 1024 742">► Consult a qualified specialist workshop.

Display messages	Possible causes/consequences and ► Solutions
Active Brake Assist Functions Currently Limited See Operator's Manual	<p>* Vehicles with Driving Assistance Package: Active Brake Assist with cross-traffic function, Evasive Steering Assist or PRE-SAFE® PLUS are temporarily unavailable or only partially available.</p> <p>Vehicles without the Driving Assistance package: Active Brake Assist is temporarily unavailable.</p> <p>The ambient conditions are outside the system limitations .</p> <ul style="list-style-type: none"> ► Drive on. As soon as the ambient conditions are within the system limitations, the system will become available again. ► If the display message does not disappear, stop the vehicle while paying attention to road and traffic conditions and restart the engine.
Active Brake Assist Functions Limited See Operator's Manual	<p>* Vehicles with Driving Assistance Package: Active Brake Assist with cross-traffic function, Evasive Steering Assist or PRE-SAFE® PLUS is malfunctioning.</p> <p>Vehicles without the Driving Assistance Package: Active Brake Assist is malfunctioning.</p> <ul style="list-style-type: none"> ► Visit a qualified specialist workshop.
PRE-SAFE Inoperative See Operator's Manual	<p>* PRE-SAFE® functions are malfunctioning.</p> <ul style="list-style-type: none"> ► Consult a qualified specialist workshop.
PRE-SAFE Impulse Side Inoperative See Operator's Manual	<p>* Side PRE-SAFE® Impulse is malfunctioning or inoperative after having already been triggered.</p> <ul style="list-style-type: none"> ► Consult a qualified specialist workshop.

Display messages	Possible causes/consequences and ► Solutions
<p>Radar Sensors Dirty See Operator's Manual</p>	<p>* The radar sensor system is malfunctioning. Possible causes are:</p> <ul style="list-style-type: none">• soiling of the sensors• heavy rain• extended driving on inter-urban roads without moving traffic, e.g. in the desert <p>Driving systems and driving safety systems may be malfunctioning or temporarily unavailable. When the causes no longer apply, driving systems and driving safety systems are available again. If the display message does not disappear:</p> <ul style="list-style-type: none">► Pull over and stop the vehicle safely as soon as possible, paying attention to road and traffic conditions.► Clean all sensors .► Restart the engine.





Display messages	Possible causes/consequences and ► Solutions
<div data-bbox="130 187 327 291" data-label="Image"> </div> <p data-bbox="118 301 429 363">SRS Malfunction Service Required</p>	<p data-bbox="527 182 1195 215">* The restraint system is malfunctioning (→ page 27).</p> <div data-bbox="553 236 1984 288" data-label="Text"> <p>▲ WARNING Risk of injury or fatal injury due to a malfunction in the restraint system</p> </div> <p data-bbox="568 298 1921 394">If the restraint system is malfunctioning, restraint system components may be triggered unintentionally or might not be triggered at all in the event of an accident. This may affect the Emergency Tensioning Device or airbag, for example.</p> <p data-bbox="568 405 1798 438">► Have the restraint system checked and repaired immediately at a qualified specialist workshop.</p> <p data-bbox="553 469 1089 502">Recognizing a restraint system malfunction</p> <ul data-bbox="553 512 1768 588" style="list-style-type: none"> • The restraint system warning lamp  does not light up when the ignition is switched on. • The restraint system warning lamp  lights up continuously or repeatedly during a journey. <p data-bbox="553 609 1205 642">► Visit a qualified specialist workshop immediately.</p>



Display messages	Possible causes/consequences and ► Solutions
 <p data-bbox="57 301 380 363">Example: Front Left Malfunction Service Required</p>	<p data-bbox="466 184 1316 215">* The corresponding restraint system is malfunctioning (→ page 27).</p> <div data-bbox="492 236 1917 449" style="border: 1px solid gray; padding: 5px;"> <p data-bbox="513 246 1594 280">▲ WARNING Risk of injury or fatal injury due to a malfunction in the restraint system</p> <p data-bbox="513 298 1855 394">If the restraint system is malfunctioning, restraint system components may be triggered unintentionally or might not be triggered at all in the event of an accident. This may affect the Emergency Tensioning Device or airbag, for example.</p> <p data-bbox="513 408 1735 439">► Have the restraint system checked and repaired immediately at a qualified specialist workshop.</p> </div> <p data-bbox="492 470 1030 501">Detection of a restraint system malfunction</p> <ul data-bbox="492 511 1698 588" style="list-style-type: none"> <li data-bbox="492 511 1663 542">• The  restraint system warning lamp does not light up when the ignition is switched on. <li data-bbox="492 553 1698 588">• The  restraint system warning lamp lights up continuously or repeatedly during a journey. <p data-bbox="492 609 1183 640">► Consult a qualified specialist workshop immediately.</p>
 <p data-bbox="57 772 394 866">Example: Left Side Curtain Airbag Malfunction Service Required</p>	<p data-bbox="466 655 1295 686">* The corresponding window airbag is malfunctioning (→ page 32).</p> <div data-bbox="492 707 1917 888" style="border: 1px solid gray; padding: 5px;"> <p data-bbox="513 717 1561 752">▲ WARNING Risk of injury or fatal injury due to malfunctions in the window airbag</p> <p data-bbox="513 769 1855 831">If the window airbag is malfunctioning, it might be triggered unintentionally or might not be triggered at all in the event of an accident with high deceleration.</p> <p data-bbox="513 845 1712 876">► Have the window airbag checked and repaired immediately at a qualified specialist workshop.</p> </div> <p data-bbox="492 907 1183 938">► Consult a qualified specialist workshop immediately.</p>



Display messages	Possible causes/consequences and ► Solutions
 <p>Inoperative</p>	<ul style="list-style-type: none"> * One or more main features of the mbrace system are malfunctioning. <ul style="list-style-type: none"> ► Consult a qualified specialist workshop.
<p>Front Passenger Airbag Disabled See Operator's Manual</p>	<ul style="list-style-type: none"> * The front passenger airbag and the knee airbag are deactivated, even though an adult or a person with a build corresponding to that of an adult is seated on the front passenger seat. If additional forces are applied to the seat, the system may interpret the occupant's weight as lower than it actually is. <div style="background-color: #e0e0e0; padding: 5px; margin: 10px 0;"> <p>▲ WARNING Risk of injury or fatal injury due to a disabled front passenger airbag</p> </div> <p>If the front passenger airbag is disabled, the front passenger airbag will not be deployed in the event of an accident and cannot perform its intended protective function.</p> <p>A person in the front passenger seat could then, for example, come into contact with the vehicle's interior, especially if the person is sitting too close to the cockpit.</p> <ul style="list-style-type: none"> ► Make sure, both before and during the journey, that the status of the front passenger airbag is correct. <ul style="list-style-type: none"> ► Pull over and stop the vehicle safely as soon as possible, paying attention to road and traffic conditions. ► Check the status of the automatic front passenger airbag shutoff . ► If necessary, consult a qualified specialist workshop immediately.

Display messages	Possible causes/consequences and ► Solutions
<p>Front Passenger Airbag Enabled See Operator's Manual</p>	<p>* The front passenger airbag and knee airbags are enabled during the journey:</p> <ul style="list-style-type: none">• Even when a child, a small adult or an object weighing less than the system weight threshold is located on the front passenger seat.• Even when the front passenger seat is not occupied. <p>The system may detect objects or forces applying additional weight on the seat.</p> <p>▲ WARNING Risk of injury or fatal injury by using a child restraint system with the front passenger airbag enabled</p> <p>If you secure a child in a child restraint system on the front passenger seat and the front passenger airbag is enabled, the front passenger airbag can deploy in the event of an accident.</p> <p>The child could be struck by the airbag.</p> <p>► Make sure, both before and during the journey, that the status of the front passenger airbag is correct.</p> <ul style="list-style-type: none">► Pull over and stop the vehicle safely as soon as possible, paying attention to road and traffic conditions.► Check the status of the automatic front passenger airbag shutoff .► If necessary, consult a qualified specialist workshop immediately.

Driving systems

Display messages	Possible causes/consequences and ► Solutions
 <p>ATTENTION ASSIST: Take a Break!</p>	<ul style="list-style-type: none">* ATTENTION ASSIST has detected fatigue or an increasing lack of concentration on the part of the driver (→ page 191).<ul style="list-style-type: none">► If necessary, take a break.
 <p>ATTENTION ASSIST Inoperative</p>	<ul style="list-style-type: none">* ATTENTION ASSIST is malfunctioning.<ul style="list-style-type: none">► Consult a qualified specialist workshop.
 <p>Vehicle Rising</p>	<ul style="list-style-type: none">* Your vehicle is adjusting to the level you have selected.
 <p>Vehicle Rising Please Wait</p>	<ul style="list-style-type: none">* The vehicle level is too low and the vehicle rises to the selected vehicle level.<ul style="list-style-type: none">► Wait until the display message disappears before pulling away.

Display messages	Possible causes/consequences and ► Solutions
 <p data-bbox="57 301 355 360">Malfunction See Operator's Manual</p>	<ul style="list-style-type: none"> * The AIR BODY CONTROL function is restricted. The vehicle's handling characteristics may be affected. <ul style="list-style-type: none"> ► Drive in a manner appropriate for the current level, but do not exceed 50 mph (80 km/h). ► Consult a qualified specialist workshop.
 <p data-bbox="57 496 369 555">Stop Vehicle Vehicle Too Low</p>	<ul style="list-style-type: none"> * You have pulled away although the vehicle level was too low. <ul style="list-style-type: none"> ► Pull over and stop the vehicle safely as soon as possible, paying attention to road and traffic conditions. The vehicle rises to the selected vehicle level. ► Wait until the display message disappears before pulling away. <p>If the display message does not disappear and a warning tone also sounds, AIR BODY CONTROL is malfunctioning:</p> <ul style="list-style-type: none"> ► Do not drive faster than 50 mph (80 km/h) and consult a qualified specialist workshop immediately. <div style="border: 1px solid gray; padding: 5px; margin-top: 10px;"> <p>! NOTE The tires of the front axle or the front fenders could be damaged by large steering movements</p> <ul style="list-style-type: none"> ► Avoid large steering movements while driving and listen for scraping sounds. ► If you hear scraping sounds, pull over and stop the vehicle safely, paying attention to road and traffic conditions, and set a higher vehicle level if possible. </div> <ul style="list-style-type: none"> ► Set a higher vehicle level . Depending on the malfunction, the vehicle is raised.

Display messages	Possible causes/consequences and ► Solutions
 <p>Drive More Slowly</p>	<ul style="list-style-type: none"> * You are driving too fast for the selected vehicle level. <ul style="list-style-type: none"> ► In order to adjust the vehicle level, you must not drive faster than 50 mph (80 km/h). ► In order to adjust the vehicle level during trailer operation, you must not drive faster than 19 mph (30 km/h).
 <p>Compressor Is Cooling</p>	<ul style="list-style-type: none"> * Due to frequent level changes within a short space of time, the compressor first needs to cool down in order to set the selected vehicle level. <ul style="list-style-type: none"> ► Drive on in a manner appropriate for the current level. Make sure that there is sufficient ground clearance. When the compressor has cooled down, the vehicle continues rising to the selected vehicle level.
<p>Active Lane Keeping Assist Currently Unavailable See Operator's Manual</p>	<ul style="list-style-type: none"> * Active Lane keeping Assist is temporarily unavailable. The ambient conditions are outside the system limits (→ page 195). Vehicles with Steering Pilot: The camera view may be restricted by the windshield. <ul style="list-style-type: none"> ► Drive on. As soon as the ambient conditions are within the system limits, the system will become available again. <p>If the display message does not disappear on vehicles with Steering Pilot:</p> <ul style="list-style-type: none"> ► Pull over and stop the vehicle safely as soon as possible, paying attention to road and traffic conditions. ► Clean the windshield.
<p>Active Lane Keeping Assist Inoperative</p>	<ul style="list-style-type: none"> * Active Lane Keeping Assist is malfunctioning. <ul style="list-style-type: none"> ► Consult a qualified specialist workshop.

Display messages	Possible causes/consequences and ► Solutions
<p>Active Lane Keeping Assist Camera View Restricted See Operator's Manual</p>	<p>* Vehicles without Steering Pilot: The camera view is reduced. Possible causes are:</p> <ul style="list-style-type: none">• Dirt on the windshield in the camera's field of vision• Heavy rain, snow or fog <p>Driving systems and driving safety systems may be malfunctioning or temporarily unavailable. When the causes no longer apply, driving systems and driving safety systems are available again. If the display message does not disappear:</p> <ul style="list-style-type: none">► Pull over and stop the vehicle safely as soon as possible, paying attention to road and traffic conditions.► Clean the windshield.
<p>Blind Spot Assist Currently Unavailable See Operator's Manual</p>	<p>* Blind Spot Assist is temporarily unavailable. The system limits have been reached (→ page 193).</p> <ul style="list-style-type: none">► Drive on. When the causes no longer apply, the system will be available again. <p>or</p> <ul style="list-style-type: none">► If the display message does not disappear, stop the vehicle while paying attention to road and traffic conditions and restart the engine.► If necessary, clean the rear bumper. If the bumper is extremely dirty, the sensors in the bumper may be malfunctioning.

Display messages	Possible causes/consequences and ► Solutions
Active Blind Spot Assist Currently Unavailable See Operator's Manual	<ul style="list-style-type: none"> * Active Blind Spot Assist is temporarily unavailable. The system limits have been reached (→ page 193). <ul style="list-style-type: none"> ► Drive on. When the causes no longer apply, the system will be available again. ► If the display message does not disappear, stop the vehicle while paying attention to road and traffic conditions and restart the engine.
Blind Spot Assist Inoperative	<ul style="list-style-type: none"> * Blind Spot Assist is malfunctioning. <ul style="list-style-type: none"> ► Consult a qualified specialist workshop.
Active Blind Spot Assist Inoperative	<ul style="list-style-type: none"> * Active Blind Spot Assist is malfunctioning. <ul style="list-style-type: none"> ► Consult a qualified specialist workshop.
Example: Parking Pilot Parking Canceled	<ul style="list-style-type: none"> * The parking assistance systems of Parking Pilot were interrupted. You have opened the driver's door or touched the steering wheel, for example. <ul style="list-style-type: none"> ► Steer and brake manually.
<div style="border: 2px solid black; padding: 5px; display: inline-block; margin-bottom: 5px;">HOLD</div> Off	<ul style="list-style-type: none"> * The HOLD function is deactivated because the vehicle is skidding or a condition for activation is not met. <ul style="list-style-type: none"> ► Reactivate the HOLD function later or check the activation conditions for the HOLD function .
Distance Pilot Now Available	<ul style="list-style-type: none"> * Distance Pilot DISTRONIC is operational again and can be activated (→ page 167).

Display messages	Possible causes/consequences and ► Solutions
<p>Distance Pilot Currently Unavailable See Operator's Manual</p>	<ul style="list-style-type: none"> * Distance Pilot DISTRONIC is temporarily unavailable. The ambient conditions are outside the system limits (→ page 165). <ul style="list-style-type: none"> ► Drive on. As soon as the ambient conditions are within the system limits, the system will become available again.
<p>Distance Pilot Inoperative</p>	<ul style="list-style-type: none"> * Distance Pilot DISTRONIC is malfunctioning. Other driving and driving safety systems may also be malfunctioning. <ul style="list-style-type: none"> ► Consult a qualified specialist workshop.
<p>Steering Pilot Currently Unavailable See Operator's Manual</p>	<ul style="list-style-type: none"> * Steering Pilot is temporarily unavailable. The ambient conditions are outside the system limits (→ page 171). <ul style="list-style-type: none"> ► Drive on. As soon as the ambient conditions are within the system limits, the system will become available again. ► If necessary, clean the windshield in the camera's field of vision.
<p>Steering Pilot Inoperative</p>	<ul style="list-style-type: none"> * Steering Pilot is malfunctioning. Distance Pilot DISTRONIC remains available. <ul style="list-style-type: none"> ► Consult a qualified specialist workshop.
 <p style="margin-left: 10px;">--- mph</p>	<ul style="list-style-type: none"> * Cruise control cannot be activated as not all activation conditions are fulfilled. <ul style="list-style-type: none"> ► Observe the activation conditions for cruise control .
<p>Cruise Control Off</p>	<ul style="list-style-type: none"> * Cruise control has been deactivated. If there is an additional warning tone, cruise control has been deactivated automatically (→ page 163).



Display messages	Possible causes/consequences and ► Solutions
Blind Spot Assist Not Available When Towing a Trailer See Operator's Manual	<ul style="list-style-type: none"> * When you establish the electrical connection to the trailer, Blind Spot Assist is unavailable. <ul style="list-style-type: none"> ► Press the left-hand Touch Control and confirm the display message.
Active Blind Spot Asst. Not Available When Towing a Trailer See Operator's Manual	<ul style="list-style-type: none"> * When you establish the electrical connection to the trailer, Active Blind Spot Assist is unavailable. <ul style="list-style-type: none"> ► Press the left-hand Touch Control and confirm the display message.
Cruise Control Inoperative	<ul style="list-style-type: none"> * Cruise control is malfunctioning. <ul style="list-style-type: none"> ► Consult a qualified specialist workshop.
Parking Pilot Maneuvering Assistance Restricted See Operator's Manual	<ul style="list-style-type: none"> * Parking Pilot and Parking Assist PARKTRONIC are temporarily unavailable. The ambient conditions are outside the system limits (→ page 186). Beware of the entire vehicle surroundings. <ul style="list-style-type: none"> ► As soon as the ambient conditions are within the system limits, the system will become available again.
Parking Pilot and PARKTRONIC Inoperative See Operator's Manual	<ul style="list-style-type: none"> * Parking Pilot and Parking Assist PARKTRONIC are malfunctioning. <ul style="list-style-type: none"> ► Stop the vehicle, paying attention to road and traffic conditions, and restart the engine. ► If the display message continues to be displayed, consult a qualified specialist workshop.

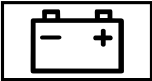
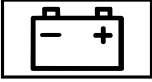

Engine

Display messages	Possible causes/consequences and ► Solutions
Check Coolant Level See Operator's Manual	<p>* The coolant level is too low.</p> <div data-bbox="492 288 1917 394" style="border: 1px solid gray; padding: 5px;"><p>! NOTE Engine damage due to insufficient coolant</p><p>► Avoid long journeys with insufficient coolant.</p></div> <p>► Add coolant .</p>
	<p>* The fan motor is malfunctioning.</p> <p>► Avoiding high loads on the engine, drive on to the nearest qualified specialist workshop. In doing so, ensure that the coolant temperature display remains below 248 °F (120 °C).</p>

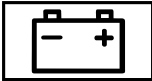
Display messages	Possible causes/consequences and ► Solutions
 <p data-bbox="118 301 461 363">Coolant Too Hot Stop Vehicle Turn Engine Off</p>	<p data-bbox="527 184 829 210">* The coolant is too hot.</p> <ul data-bbox="553 228 1949 260" style="list-style-type: none"><li data-bbox="553 228 1949 260">► Pull over and stop the vehicle safely and switch off the engine, paying attention to road and traffic conditions. <div data-bbox="553 291 1982 512" style="border: 1px solid gray; padding: 5px;"><p data-bbox="578 301 1269 332">▲ WARNING Danger of burns when opening the hood</p><p data-bbox="574 350 1909 415">If you open the hood when the engine has overheated or during a fire in the engine compartment, you could come into contact with hot gases or other escaping operating fluids.</p><ul data-bbox="574 425 1796 498" style="list-style-type: none"><li data-bbox="574 425 1316 456">► Before opening the hood, allow the engine to cool down.<li data-bbox="574 467 1796 498">► In the event of a fire in the engine compartment, keep the hood closed and call the fire service.</div> <ul data-bbox="553 534 1984 681" style="list-style-type: none"><li data-bbox="553 534 1075 565">► Wait until the engine has cooled down.<li data-bbox="553 576 1367 607">► Make sure that the air supply to the radiator is not obstructed.<li data-bbox="553 617 1984 681">► Avoiding high loads on the engine, drive on to the nearest qualified specialist workshop. In doing so, ensure that the coolant temperature display remains below 248 °F (120 °C).

Display messages	Possible causes/consequences and ► Solutions
 <p data-bbox="57 301 343 329">See Operator's Manual</p>	<p data-bbox="466 184 901 212">* The battery is not being charged.</p> <div data-bbox="492 239 1917 387" style="border: 1px solid gray; padding: 5px;"> <p data-bbox="517 249 1228 277">! NOTE Possible engine damage if you continue driving</p> <ul style="list-style-type: none"> <li data-bbox="517 301 1173 329">▶ Do not continue driving under any circumstances. <li data-bbox="517 342 1048 370">▶ Consult a qualified specialist workshop. </div> <ul style="list-style-type: none"> <li data-bbox="492 408 1888 436">▶ Pull over and stop the vehicle safely and switch off the engine, paying attention to road and traffic conditions. <li data-bbox="492 449 1024 477">▶ Consult a qualified specialist workshop.
 <p data-bbox="57 617 363 674">Stop Vehicle See Operator's Manual</p>	<p data-bbox="466 500 1453 528">* The battery is no longer being charged and the battery charge level is too low.</p> <div data-bbox="492 555 1917 703" style="border: 1px solid gray; padding: 5px;"> <p data-bbox="517 565 1228 593">! NOTE Possible engine damage if you continue driving</p> <ul style="list-style-type: none"> <li data-bbox="517 617 1173 645">▶ Do not continue driving under any circumstances. <li data-bbox="517 658 1048 686">▶ Consult a qualified specialist workshop. </div> <ul style="list-style-type: none"> <li data-bbox="492 724 1909 783">▶ Pull over and stop the vehicle safely as soon as possible, paying attention to road and traffic conditions. Do not continue driving under any circumstances. <li data-bbox="492 796 805 824">▶ Switch off the engine. <li data-bbox="492 838 1024 866">▶ Consult a qualified specialist workshop.

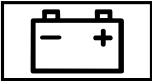
Display messages	Possible causes/consequences and ► Solutions
 <p data-bbox="118 301 451 363">Stop Vehicle Leave Engine Running</p>	<p data-bbox="527 184 983 215">* The battery charge level is too low.</p> <ul style="list-style-type: none"> <li data-bbox="553 228 1974 291">► Pull over and stop the vehicle safely as soon as possible, paying attention to road and traffic conditions. Do not continue driving under any circumstances. <li data-bbox="553 301 805 332">► Start the engine. <li data-bbox="553 342 1371 373">► Wait until the display message disappears before pulling away.
 <p data-bbox="118 508 437 570">Check Engine Oil At Next Refueling</p>	<p data-bbox="527 391 1228 422">* The engine oil level has dropped to the minimum level.</p> <div data-bbox="553 443 1980 550" style="border: 1px solid black; padding: 5px;"> <p data-bbox="580 456 1459 487">! NOTE Engine damage caused by driving with insufficient engine oil</p> <ul style="list-style-type: none"> <li data-bbox="574 505 1201 536">► Avoid long journeys with insufficient engine oil. </div> <ul style="list-style-type: none"> <li data-bbox="553 570 1173 601">► Check the engine oil level when next refueling. <p data-bbox="553 622 915 653">Add engine oil (→ page 254).</p> <p data-bbox="553 664 977 695">Notes on engine oil (→ page 320).</p>
 <p data-bbox="118 829 308 857">Fuel Level Low</p>	<p data-bbox="527 712 1167 743">* The fuel level has dropped into the reserve range.</p> <ul style="list-style-type: none"> <li data-bbox="553 754 682 785">► Refuel.

Display messages	Possible causes/consequences and ► Solutions
 <p data-bbox="57 301 359 360">Start Engine See Operator's Manual</p>	<ul style="list-style-type: none"> * The engine is off and the battery charge level is too low. <ul style="list-style-type: none"> ► Switch off electrical consumers that are not required. ► Leave the engine running for a few minutes, or drive for a longer distance. The battery charges.
 <p data-bbox="57 496 247 524">Gas Cap Loose</p>	<ul style="list-style-type: none"> * There has been pressure loss in the fuel system. The fuel filler cap is not closed correctly or the fuel system is leaking. <ul style="list-style-type: none"> ► Close the fuel filler cap. ► If the fuel filler cap was already properly closed: consult a qualified specialist workshop.

Tires

Display messages	Possible causes/consequences and ► Solutions
 <p data-bbox="57 817 369 876">Please Correct Tire Pressure</p>	<ul style="list-style-type: none"> * The tire pressure is too low in at least one of the tires, or the tire pressure differences between the wheels is too great. <ul style="list-style-type: none"> ► Check the tire pressure and add air, if necessary. ► If the tire pressure is correct, restart the tire pressure monitoring system .



Display messages	Possible causes/consequences and ► Solutions
 <p data-bbox="118 301 269 327">Check Tires</p>	<p data-bbox="527 184 1739 215">* The tire pressure in one or more tires has dropped significantly. The wheel position is displayed.</p> <div data-bbox="553 236 1984 291"><p data-bbox="578 246 1402 277">▲ WARNING Risk of an accident due to insufficient tire pressure</p></div> <p data-bbox="574 298 1299 329">Tire pressures that are too low pose the following hazards:</p> <ul data-bbox="584 342 1698 456" style="list-style-type: none"><li data-bbox="584 342 1488 373">• The tires may burst, especially as the load and vehicle speed increase.<li data-bbox="584 384 1698 415">• The tires may wear excessively and/or unevenly, which may greatly impair tire traction.<li data-bbox="584 425 1663 456">• The driving characteristics, as well as steering and braking, may be greatly impaired. <p data-bbox="574 477 1095 508">You could then lose control of the vehicle.</p> <ul data-bbox="574 519 1126 591" style="list-style-type: none"><li data-bbox="574 519 1126 550">► Observe the recommended tire pressure.<li data-bbox="574 560 1075 591">► Adjust the tire pressure if necessary. <ul data-bbox="553 627 1385 700" style="list-style-type: none"><li data-bbox="553 627 1385 658">► Stop the vehicle, paying attention to road and traffic conditions.<li data-bbox="553 669 1058 700">► Check the tire pressure and the tires.



Display messages	Possible causes/consequences and ► Solutions
 <p data-bbox="57 301 369 329">Warning Tire Malfunction</p>	<p data-bbox="466 184 1637 212">* The tire pressure in one or more tires has dropped suddenly. The wheel position is displayed.</p> <div data-bbox="492 236 1917 565" style="border: 1px solid gray; padding: 5px;"> <p data-bbox="513 246 1279 274">▲ WARNING Risk of an accident from driving with a flat tire</p> <p data-bbox="513 298 1079 326">Flat tires are dangerous in the following ways:</p> <ul data-bbox="513 342 1596 412" style="list-style-type: none"> <li data-bbox="513 342 1044 370">• The tires can overheat and cause a fire. <li data-bbox="513 384 1596 412">• The driving characteristics, as well as steering and braking, may be greatly impaired. <p data-bbox="513 436 1030 464">You could then lose control of the vehicle.</p> <ul data-bbox="513 477 942 547" style="list-style-type: none"> <li data-bbox="513 477 895 505">► Do not drive with a flat tire. <li data-bbox="513 519 942 547">► Observe the notes on flat tires. </div> <p data-bbox="486 588 895 616">Notes on flat tires (→ page 264).</p> <ul data-bbox="486 629 1324 699" style="list-style-type: none"> <li data-bbox="486 629 1324 657">► Stop the vehicle, paying attention to road and traffic conditions. <li data-bbox="486 671 731 699">► Check the tires.
<p data-bbox="57 726 355 785">Tire Press. Monitor Currently Unavailable</p>	<p data-bbox="466 718 1876 778">* No signals can be received from the tire pressure sensor due to strong radio signal source interference. The tire pressure monitoring system is temporarily unavailable.</p> <ul data-bbox="486 791 1759 850" style="list-style-type: none"> <li data-bbox="486 791 1759 850">► Drive on. The tire pressure monitoring system restarts automatically as soon as the cause has been rectified.

Display messages	Possible causes/consequences and ► Solutions
 <p>Wheel Sensor(s) Missing</p>	<ul style="list-style-type: none"> * There is no signal from the tire pressure sensor of one or several tires. The pressure of the affected tire is not displayed. <ul style="list-style-type: none"> ► Have the defective tire pressure sensor replaced at a qualified specialist workshop.
<p>Tire Pressure Monitor Inoperative No Wheel Sensors</p>	<ul style="list-style-type: none"> * The wheels mounted do not have suitable tire pressure sensors. The tire pressure monitoring system is deactivated. <ul style="list-style-type: none"> ► Mount wheels with suitable tire pressure sensors.
<p>Tire Press. Monitor Inoperative</p>	<ul style="list-style-type: none"> * The tire pressure monitoring system is malfunctioning. <div style="border: 1px solid gray; padding: 5px; margin-top: 10px;"> <p>⚠ WARNING There is a risk of an accident if the tire pressure monitoring system is malfunctioning</p> <p>If the tire pressure monitoring system is malfunctioning, it is not able to issue a warning if there is pressure loss in one or more of the tires.</p> <p>Underinflated tires may, for example, impair the driving, steering and braking characteristics.</p> <ul style="list-style-type: none"> ► Have the tire pressure monitoring system checked at a qualified specialist workshop. </div> <ul style="list-style-type: none"> ► Consult a qualified specialist workshop.
<p>Tires Overheated</p>	<ul style="list-style-type: none"> * At least one tire is overheated. The affected tires are displayed in red. At temperatures close to the limit value, the tires are displayed in yellow. <ul style="list-style-type: none"> ► Drive more slowly.

Display messages	Possible causes/consequences and ► Solutions
<p>Tires Overheated Decrease Speed</p>	<p>* At least one tire is overheated.</p> <div style="background-color: #f0f0f0; padding: 5px; border: 1px solid #ccc;"> <p>▲ WARNING Risk of an accident from driving with overheated tires</p> <p>Overheated tires may burst, particularly at high speeds.</p> <p>► Reduce speed so that the tires cool down.</p> </div> <p>► Reduce speed so that the tires cool down.</p>

SmartKey

Display messages	Possible causes/consequences and ► Solutions
 <p>Obtain a New Key</p>	<p>* The SmartKey needs to be replaced.</p> <p>► Consult a qualified specialist workshop.</p>
 <p>Replace Key Battery</p>	<p>* The SmartKey battery is discharged.</p> <p>► Change the battery .</p>

Display messages	Possible causes/consequences and ► Solutions
 <p>Key Not Detected (white display message)</p>	<ul style="list-style-type: none"> * The SmartKey is currently undetected. <ul style="list-style-type: none"> ► Change the location of the SmartKey in the vehicle. ► If the SmartKey is still not detected, start the engine with the SmartKey in the stowage compartment .
 <p>Place the Key in the Marked Space See Operator's Manual</p>	<ul style="list-style-type: none"> * The SmartKey detection function is malfunctioning. <ul style="list-style-type: none"> ► Change the location of the SmartKey in the vehicle. ► Start the vehicle with the SmartKey in the stowage compartment .
 <p>Key Not Detected (red display message)</p>	<ul style="list-style-type: none"> * The SmartKey cannot be detected and may no longer be in the vehicle. The SmartKey is no longer in the vehicle and you switch off the engine: <ul style="list-style-type: none"> • You can no longer start the engine. • You cannot centrally lock the vehicle. <ul style="list-style-type: none"> ► Ensure that the SmartKey is in the vehicle. <p>If the SmartKey detection function has a malfunction due to a strong radio signal source:</p> <ul style="list-style-type: none"> ► Pull over and stop the vehicle safely as soon as possible, paying attention to road and traffic conditions. ► Place the SmartKey in the stowage compartment for starting the engine with the SmartKey .



Display messages	Possible causes/consequences and ► Solutions
 <p data-bbox="57 301 333 330">Don't Forget Your Key</p>	<p data-bbox="466 184 1917 213">* A warning tone also sounds. This message reminds you to take your SmartKey with you when you leave the vehicle.</p>



Vehicle



Display messages	Possible causes/consequences and ► Solutions
<p data-bbox="57 511 374 570">Apply Brake to Shift from 'P'</p>	<p data-bbox="466 501 1770 530">* You have attempted to shift the transmission out of position P and into another transmission position.</p> <ul style="list-style-type: none"> <li data-bbox="486 542 846 571">► Depress the brake pedal.
<p data-bbox="57 601 363 698">To Deselect P or N, Depress Brake and Start Engine</p>	<p data-bbox="466 591 1794 620">* You have attempted to shift the transmission out of position P or N into another transmission position.</p> <ul style="list-style-type: none"> <li data-bbox="486 632 846 662">► Depress the brake pedal. <li data-bbox="486 674 744 703">► Start the engine.
<p data-bbox="57 733 390 826">Driver's Door Open & Transmission Not in P Risk of Vehicle Rolling Away</p>	<p data-bbox="466 723 1537 752">* The driver's door is not fully closed and the transmission is in position R, N or D.</p> <ul style="list-style-type: none"> <li data-bbox="486 764 1328 793">► Shift the transmission to position P when you park the vehicle.
<p data-bbox="57 854 390 913">N Permanently Active Risk of Rolling Away</p>	<p data-bbox="466 844 1733 873">* While the vehicle is rolling or while you are driving, the transmission has been shifted to position N.</p> <ul style="list-style-type: none"> <li data-bbox="486 885 1841 914">► Depress the brake pedal to stop and, when the vehicle is stationary, shift the transmission to position P. <li data-bbox="486 927 1391 956">► To continue your journey, shift the transmission to position D or R.

Display messages	Possible causes/consequences and ► Solutions
Only Shift to 'P' when Vehicle is Stationary	<ul style="list-style-type: none"> * The transmission can only be shifted to position P when the vehicle is stationary.
Service Required Do Not Shift Gears Visit Dealer	<ul style="list-style-type: none"> * The transmission is malfunctioning. The transmission position can no longer be shifted. <ul style="list-style-type: none"> ► When the transmission is in position D, consult a qualified specialist workshop and do not shift the transmission position. ► For all other transmission positions, park the vehicle safely. ► Consult a qualified specialist workshop or breakdown service.
 <p>Vehicle Operational Switch the Ignition Off Before Exiting</p>	<ul style="list-style-type: none"> * You are leaving the vehicle when it is in a ready-to-drive state. <ul style="list-style-type: none"> ► When you leave the vehicle, switch off the ignition and take the SmartKey with you. ► If you do not leave the vehicle, switch off the electrical consumers, e.g. the seat heater. Otherwise, the 12-volt battery might discharge and it will then only be possible to start the vehicle using a donor battery (starting assistance).
Transmission Malfunction Stop	<ul style="list-style-type: none"> * The transmission is malfunctioning. The transmission shifts to position N automatically. <ul style="list-style-type: none"> ► Pull over and stop the vehicle safely as soon as possible, paying attention to road and traffic conditions. ► Switch the transmission to position P. ► Consult a qualified specialist workshop.
Reversing Not Possible Service Required	<ul style="list-style-type: none"> * The transmission is malfunctioning. Reverse gear can no longer be engaged. <ul style="list-style-type: none"> ► Consult a qualified specialist workshop.

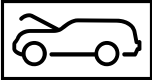

Display messages	Possible causes/consequences and ► Solutions
<p>Stop Vehicle Leave Engine Running Wait Transmission Cooling</p>	<ul style="list-style-type: none"> * The transmission has overheated. Pulling away can be temporarily impaired or not possible. <ul style="list-style-type: none"> ► Pull over and stop the vehicle safely as soon as possible, paying attention to road and traffic conditions. Do not continue driving under any circumstances. ► Start the engine. ► Wait until the display message disappears before pulling away.
<p>Auxiliary Battery Malfunction</p>	<ul style="list-style-type: none"> * The auxiliary battery for the transmission is no longer being charged. <ul style="list-style-type: none"> ► Consult a qualified specialist workshop. ► Until then, manually set the transmission to position P before you switch off the engine. ► Before leaving the vehicle, apply the electric parking brake.
<div data-bbox="69 567 263 671" data-label="Image"> </div> <p>Steering Malfunction Drive Carefully Service Required</p>	<ul style="list-style-type: none"> * The power assistance of the steering is malfunctioning. You may need to use more force to steer. <ul style="list-style-type: none"> ► Drive on carefully. ► Consult a qualified specialist workshop.

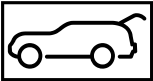



Display messages	Possible causes/consequences and ► Solutions
 <p data-bbox="118 301 451 391">Steering Malfunction Stop Immediately See Operator's Manual</p>	<p data-bbox="527 184 1488 215">* The steering is malfunctioning. Steering capability is considerably impaired.</p> <div data-bbox="553 236 1984 288"><p data-bbox="574 246 1371 277">▲ WARNING Risk of accident if steering capability is impaired</p></div> <p data-bbox="574 298 1692 329">If the steering does not function as intended, the vehicle's operating safety is jeopardized.</p> <ul data-bbox="574 339 1902 446" style="list-style-type: none"><li data-bbox="574 339 1902 401">► Pull over and stop the vehicle safely as soon as possible, paying attention to road and traffic conditions. Do not continue driving under any circumstances.<li data-bbox="574 412 1105 446">► Consult a qualified specialist workshop. <p data-bbox="553 477 1978 539">► Pull over and stop the vehicle safely as soon as possible, paying attention to road and traffic conditions. Do not continue driving under any circumstances.</p> <p data-bbox="553 550 1085 581">► Consult a qualified specialist workshop.</p>
 <p data-bbox="118 721 431 811">Steering Malfunction Increased Physical Effort See Operator's Manual</p>	<p data-bbox="527 603 1242 635">* The power assistance of the steering is malfunctioning.</p> <div data-bbox="553 655 1984 707"><p data-bbox="574 666 1488 697">▲ WARNING Risk of an accident due to altered steering characteristics</p></div> <p data-bbox="574 717 1902 749">If the power assistance of the steering fails partially or completely, you will need to use more force to steer.</p> <ul data-bbox="574 759 1365 831" style="list-style-type: none"><li data-bbox="574 759 1181 790">► If safe steering is possible, drive on carefully.<li data-bbox="574 800 1365 831">► Visit or consult a qualified specialist workshop immediately. <p data-bbox="553 862 1160 894">► If safe steering is possible, drive on carefully.</p> <p data-bbox="553 904 1344 935">► Visit or consult a qualified specialist workshop immediately.</p>

Display messages	Possible causes/consequences and ► Solutions
<p>Active Hood Malfunction See Operator's Manual</p>	<ul style="list-style-type: none"> * The active hood (pedestrian protection) is malfunctioning or inoperative after having already been triggered. <ul style="list-style-type: none"> ► Visit a qualified specialist workshop.
	<ul style="list-style-type: none"> * The engine hood is open. <div style="border: 1px solid gray; padding: 5px; margin: 10px 0;"> <p>⚠ WARNING Risk of accident if the engine hood is unlatched while driving</p> <p>An unlocked engine hood may open up when the vehicle is in motion and block your view.</p> <ul style="list-style-type: none"> ► Never unlatch the engine hood while driving. ► Before every trip, ensure that the engine hood is latched. </div> <ul style="list-style-type: none"> ► Pull over and stop the vehicle safely as soon as possible. ► Close the hood.
	<ul style="list-style-type: none"> * At least one door is open. <ul style="list-style-type: none"> ► Close all doors.

Display messages	Possible causes/consequences and ► Solutions
	<p>* The tailgate is open.</p> <div style="background-color: #f0f0f0; padding: 5px; border: 1px solid #ccc;"> <p>▲ WARNING Risk of exhaust gas poisoning</p> <p>Combustion engines emit poisonous exhaust gases such as carbon monoxide. Exhaust gases can enter the vehicle interior if the tailgate is open when the engine is running, especially if the vehicle is in motion.</p> <ul style="list-style-type: none"> ▶ Always switch off the engine before opening the tailgate. ▶ Never drive with the tailgate open. </div> <p>► Close the tailgate.</p>
 <p>Example:Rear Left Backrest Not Latched</p>	<p>* The corresponding seat backrest of the rear bench seat is not engaged.</p> <p>► Fold the corresponding seat backrest back until it engages.</p>
 <p>Check Washer Fluid</p>	<p>* The washer fluid level in the washer fluid reservoir has dropped below the minimum.</p> <p>► Add washer fluid .</p>

Lights

Display messages	Possible causes/consequences and ► Solutions
 <p data-bbox="57 350 363 412">Example: Check Left Low Beam</p>	<ul style="list-style-type: none"> * The corresponding light source is defective. <ul style="list-style-type: none"> ► Visit a qualified specialist workshop. ⓘ LED light bulbs: the display message for the corresponding lamp only appears when all the light-emitting diodes in the lamp have failed.
 <p data-bbox="57 547 394 609">Active Headlamps Inoperative</p>	<ul style="list-style-type: none"> * The active light function is malfunctioning. <ul style="list-style-type: none"> ► Consult a qualified specialist workshop.
 <p data-bbox="57 743 353 806">Malfunction See Operator's Manual</p>	<ul style="list-style-type: none"> * The exterior lighting is malfunctioning. <ul style="list-style-type: none"> ► Consult a qualified specialist workshop.

Display messages	Possible causes/consequences and ► Solutions
 <p data-bbox="118 301 472 360">Auto Lamp Function Inoperative</p>	<ul style="list-style-type: none"> <li data-bbox="519 184 977 215">* The light sensor is malfunctioning. <li data-bbox="551 225 1089 256">► Consult a qualified specialist workshop.
 <p data-bbox="118 495 335 521">Switch Off Lights</p>	<ul style="list-style-type: none"> <li data-bbox="519 381 1320 412">* You are leaving the vehicle and the lights are still switched on. <li data-bbox="551 422 1116 453">► Turn the light switch to the AUTO position.
 <p data-bbox="118 654 396 680">Switch On Headlamps</p>	<ul style="list-style-type: none"> <li data-bbox="519 540 972 571">* You are driving without low beam. <li data-bbox="551 582 1222 613">► Turn the light switch to the  or AUTO position.
<p data-bbox="118 707 449 769">Adaptive Highbeam Assist Inoperative</p>	<ul style="list-style-type: none"> <li data-bbox="519 700 1103 731">* Adaptive Highbeam Assist is malfunctioning. <li data-bbox="551 741 1089 772">► Consult a qualified specialist workshop.
<p data-bbox="118 796 449 889">Adaptive Highbeam Assist Currently Unavailable See Operator's Manual</p>	<ul style="list-style-type: none"> <li data-bbox="519 789 1208 861">* Adaptive Highbeam Assist is temporarily unavailable. The system limits have been reached (→ page 116). <li data-bbox="551 872 1978 965">► Drive on. When the causes no longer apply, the system will be available again. The Adaptive Highbeam Assist Now Available display message appears.

Display messages	Possible causes/consequences and ► Solutions
<p>Adaptive Highbeam Assist Camera View Restricted See Operator's Manual</p>	<p>* The camera view is reduced. Possible causes are:</p> <ul style="list-style-type: none"> • Dirt on the windshield in the camera's field of vision • Heavy rain, snow or fog <p>Driving systems and driving safety systems may be malfunctioning or temporarily unavailable. When the causes no longer apply, driving systems and driving safety systems are available again. If the display message does not disappear:</p> <ul style="list-style-type: none"> ► Pull over and stop the vehicle safely as soon as possible, paying attention to road and traffic conditions. ► Clean the windshield.

Warning and indicator lamps









Overview of warning and indicator lamps















Some systems perform a self-test when the ignition is switched on. Some warning and indicator lamps may briefly light up or flash. This behavior is non-critical. These warning and indicator lamps only indicate a malfunction if they light up or flash after the engine is started or during a journey.

Instrument Display (standard)



Warning and indicator lamps:

-  Low beam (→ page 114)
-  Parking lights (→ page 114)
-  High beam (→ page 115)
-   Turn signal light (→ page 115)
-  Rear fog light (→ page 114)
-  Seat belt is not fastened (→ page 377)
-  BRAKE USA: brakes (red) (→ page 369)
-  (D) Canada: brakes (red) (→ page 369)

	ABS defective (→ page 369)		Electric parking brake (yellow) (→ page 369)		Fuel reserve with fuel filler cap location indicator (→ page 380)
	ESP® (→ page 369)		Steering assistance defective (→ page 379)		Coolant too hot/cold (→ page 380)
	ESP® OFF (→ page 369)		Electrical fault (→ page 380)		Distance warning (→ page 378)
	USA: electric parking brake applied (red) (→ page 369)		Restraint system (→ page 369)		Tire pressure monitoring system (→ page 384)
	Canada: electric parking brake applied (red) (→ page 369)		Engine diagnosis (→ page 380)		

Safety systems

Warning/indicator lamp	Possible causes/consequences and ► Solutions
<div data-bbox="130 553 324 653" style="border: 2px solid black; padding: 10px; text-align: center; font-size: 2em; font-weight: bold; margin-bottom: 10px;">RBS</div> <p>RBS warning lamp (USA/CND)</p>	<p>The yellow RBS warning lamp is lit while the engine is running.</p> <div style="background-color: #f0f0f0; padding: 10px; margin-bottom: 10px;"> <p>⚠ WARNING Risk of an accident due to a brake system malfunction</p> <p>If the brake system is malfunctioning, braking characteristics may be impaired.</p> <ul style="list-style-type: none"> ▶ Drive on carefully. ▶ Have the brake system checked immediately at a qualified specialist workshop. </div> <ul style="list-style-type: none"> ▶ Adjust your speed and continue to drive carefully, leaving a suitable distance to the vehicle in front. ▶ If the multifunction display shows a display message, please observe this. ▶ Visit a qualified specialist workshop.

Warning/indicator lamp



Brake warning lamp (USA)



Brakes warning lamp (Canada)

Possible causes/consequences and ► Solutions

The red brake system warning lamp is lit while the engine is running.

Possible causes are:

- The brake force boosting is malfunctioning and the braking characteristics may be affected.
- There is not enough brake fluid in the brake fluid reservoir.

▲ WARNING There is a risk of an accident if brake force boosting is malfunctioning

If brake force boosting is malfunctioning, the wheels may lock when braking. Braking characteristics may be impaired. The braking distance in an emergency braking situation can increase.



- Pull over and stop the vehicle safely as soon as possible, paying attention to road and traffic conditions. Do not continue driving under any circumstances.
- Consult a qualified specialist workshop.

▲ WARNING Risk of an accident due to low brake fluid level

If the brake fluid level is too low, the braking effect and the braking characteristics may be impaired.

- Pull over and stop the vehicle safely as soon as possible, paying attention to road and traffic conditions. Do not continue driving under any circumstances.
- Consult a qualified specialist workshop.
Do not add brake fluid.

Warning/indicator lamp	Possible causes/consequences and ► Solutions
	<ul style="list-style-type: none"><li data-bbox="506 177 1999 239">► Pull over and stop the vehicle safely as soon as possible, paying attention to road and traffic conditions. Do not continue driving under any circumstances.<li data-bbox="506 249 1999 280">► Observe the messages in the multifunction display.<li data-bbox="506 291 1999 322">► Consult a qualified specialist workshop. <p data-bbox="506 327 1999 389">USA only: if an additional display message appears with the  symbol in the multifunction display, the brake linings have reached their wear limit.</p> <ul style="list-style-type: none"><li data-bbox="506 405 1999 434">► Visit a qualified specialist workshop.

Warning/indicator lamp	Possible causes/consequences and ► Solutions
 <p data-bbox="57 301 288 329">ABS warning lamp</p>	<p data-bbox="441 184 1212 215">The yellow ABS warning lamp is lit while the engine is running.</p> <p data-bbox="441 228 721 260">ABS is malfunctioning.</p> <p data-bbox="441 273 1187 304">If there is an additional warning tone, EBD is malfunctioning.</p> <p data-bbox="441 318 1177 349">Other driving and driving safety systems may also be faulty.</p> <div data-bbox="441 366 1923 629" style="border: 1px solid black; padding: 5px;"> <p data-bbox="457 377 1349 408">⚠ WARNING There is risk of skidding if EBD or ABS is malfunctioning</p> <p data-bbox="457 428 1310 459">If EBD or ABS is malfunctioning, the wheels could lock when braking</p> <p data-bbox="457 470 1841 532">The steering capability and braking characteristics are thus severely impaired. The braking distance in an emergency braking situation can increase. In addition, other driving safety systems are switched off.</p> <ul style="list-style-type: none"> <li data-bbox="457 542 731 573">▶ Drive on carefully. <li data-bbox="457 584 1488 615">▶ Have the brake system checked immediately at a qualified specialist workshop. </div> <ul style="list-style-type: none"> <li data-bbox="441 656 711 687">▶ Drive on carefully. <li data-bbox="441 698 1116 729">▶ Observe the messages in the multifunction display. <li data-bbox="441 739 936 770">▶ Visit a qualified specialist workshop.
 <p data-bbox="57 902 396 933">ESP® warning lamp flashes</p>	<p data-bbox="441 785 1289 816">The yellow ESP® warning lamp flashes while the vehicle is in motion.</p> <p data-bbox="441 829 697 860">ESP® is intervening .</p> <ul style="list-style-type: none"> <li data-bbox="441 871 1279 902">▶ Adapt your driving style to suit the road and weather conditions.

Warning/indicator lamp	Possible causes/consequences and ► Solutions
 <p data-bbox="118 301 439 366">ESP® warning lamp lights up</p>	<p data-bbox="502 187 1289 308">The yellow ESP® warning lamp is lit while the engine is running. ESP® is malfunctioning. Other driving and driving safety systems may also be malfunctioning.</p> <div data-bbox="502 329 1984 560" style="border: 1px solid gray; padding: 5px;"><p data-bbox="519 339 1234 377">⚠ WARNING Risk of skidding if ESP® is malfunctioning</p><p data-bbox="519 394 1937 456">If ESP® is malfunctioning, ESP® cannot carry out vehicle stabilization. In addition, other driving safety systems are switched off.</p><ul data-bbox="519 470 1244 550" style="list-style-type: none"><li data-bbox="519 470 793 501">▶ Drive on carefully.<li data-bbox="519 515 1244 550">▶ Have ESP® checked at a qualified specialist workshop.</div> <ul data-bbox="502 581 1181 700" style="list-style-type: none"><li data-bbox="502 581 772 612">▶ Drive on carefully.<li data-bbox="502 625 1181 656">▶ Observe the messages in the multifunction display.<li data-bbox="502 670 1040 700">▶ Consult a qualified specialist workshop.

Warning/indicator lamp



ESP® OFF warning lamp

Possible causes/consequences and ► Solutions

The yellow ESP® OFF warning lamp is lit while the engine is running.
ESP® is deactivated.

▲ WARNING Risk of skidding when driving with ESP® deactivated



If ESP® is deactivated, ESP® cannot carry out vehicle stabilization. The availability of further driving safety systems is also limited.

- ▶ Drive on carefully.
- ▶ Only deactivate ESP® for as long as the situation requires.

If ESP® cannot be activated, ESP® is malfunctioning.

- ▶ Have ESP® checked immediately at a qualified specialist workshop.

- ▶ Observe the notes on deactivating ESP® .

Warning/indicator lamp	Possible causes/consequences and ► Solutions
 <p>Red indicator lamp, electric parking brake applied (USA only)</p>  <p>Red indicator lamp, electric parking brake applied (Canada only)</p>  <p>Yellow electric parking brake indicator lamp is malfunctioning</p>	<p>The red electric parking brake indicator lamp flashes or is lit. The yellow indicator lamp is also lit if the electric parking brake malfunctions.</p> <p>► Observe the messages in the multifunction display.</p>

Warning/indicator lamp

Restraint system warning lamp

Possible causes/consequences and ► Solutions

The red restraint system warning lamp is lit while the engine is running.

The restraint system is malfunctioning.



⚠ WARNING Risk of injury or fatal injury due to a malfunction in the restraint system

If the restraint system is malfunctioning, restraint system components may be triggered unintentionally or might not be triggered at all in the event of an accident. This may affect the Emergency Tensioning Device or airbag, for example.

► Have the restraint system checked and repaired immediately at a qualified specialist workshop.

- Drive on carefully.
- Observe the messages in the multifunction display.
- Visit a qualified specialist workshop immediately.

Seat belts

Warning/indicator lamp	Possible causes/consequences and ► Solutions
 <p data-bbox="118 350 408 412">Seat belt warning lamp lights up</p>	<p data-bbox="500 236 1498 308">After starting the engine, the red seat belt warning lamp lights up for 6 seconds. In addition, an acoustic warning tone may sound.</p> <p data-bbox="500 319 1645 350">The seat belt warning lamp reminds the driver and front passenger to fasten their seat belts.</p> <ul style="list-style-type: none"> <li data-bbox="500 360 827 391">► Fasten your seat belt . <p data-bbox="500 412 1596 443">If you have placed objects on the front passenger seat, the warning lamp may remain lit.</p>
 <p data-bbox="118 578 408 640">Seat belt warning lamp flashes</p>	<p data-bbox="500 464 1498 495">The red seat belt warning lamp flashes and an intermittent warning tone sounds.</p> <p data-bbox="500 505 1631 536">The driver or front passenger has not fastened their seat belt while the vehicle is in motion.</p> <ul style="list-style-type: none"> <li data-bbox="500 547 827 578">► Fasten your seat belt . <li data-bbox="500 578 1079 609">There are objects on the front passenger seat. <li data-bbox="500 619 1177 650">► Remove the objects from the front passenger seat.



Driving systems

Warning/indicator lamp	Possible causes/consequences and ► Solutions
 <p data-bbox="57 353 343 381">Distance warning lamp</p>	<p data-bbox="441 236 1310 264">The red distance warning lamp lights up while the vehicle is in motion.</p> <p data-bbox="441 277 1310 305">The distance to the vehicle in front is too small for the speed selected.</p> <p data-bbox="441 319 1565 347">If there is an additional warning tone, you are approaching an obstacle at too high a speed.</p> <ul data-bbox="441 360 911 433" style="list-style-type: none"><li data-bbox="441 360 911 388">► Be prepared to brake immediately.<li data-bbox="441 401 758 429">► Increase the distance. <p data-bbox="441 453 690 481">Active Brake Assist .</p>

Vehicle

Warning/indicator lamp	Possible causes/consequences and ► Solutions
 <p data-bbox="118 353 404 412">Power steering system warning lamp</p>	<p data-bbox="502 236 1467 308">The red power steering system warning lamp is lit while the engine is running. The power steering assistance or the steering itself is malfunctioning.</p> <div data-bbox="502 332 1984 553"><p data-bbox="519 342 1324 373">⚠ WARNING Risk of accident if steering capability is impaired</p><p data-bbox="519 391 1643 422">If the steering does not function as intended, the vehicle's operating safety is jeopardized.</p><ul data-bbox="519 433 1902 542" style="list-style-type: none"><li data-bbox="519 433 1902 501">► Pull over and stop the vehicle safely as soon as possible, paying attention to road and traffic conditions. Do not continue driving under any circumstances.<li data-bbox="519 511 1064 542">► Consult a qualified specialist workshop.</div> <p data-bbox="502 573 1181 605">► Observe the messages in the multifunction display.</p>

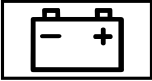
Engine

Warning/indicator lamp	Possible causes/consequences and ► Solutions
 <p data-bbox="57 350 376 412">Engine diagnosis warning lamp</p>	<p data-bbox="441 236 1365 267">The yellow engine diagnosis warning lamp is lit while the engine is running.</p> <p data-bbox="441 277 1443 308">A malfunction has occurred in the engine, the exhaust system or the fuel system.</p> <p data-bbox="441 319 1761 350">The emissions limit values may be exceeded and the engine may be running in emergency operation mode.</p> <p data-bbox="441 360 1909 426">In some states, legal requirements stipulate that you must immediately consult a qualified specialist workshop as soon as the yellow engine diagnosis warning lamp lights up.</p> <ul data-bbox="441 437 1475 468" style="list-style-type: none"> ► Have the vehicle checked as soon as possible at a qualified specialist workshop.
 <p data-bbox="57 601 408 664">Electrical malfunction warning lamp</p>	<p data-bbox="441 487 1050 513">The red electrical malfunction warning lamp is lit.</p> <p data-bbox="441 524 915 555">There is a malfunction in the electrics.</p> <ul data-bbox="441 565 1116 596" style="list-style-type: none"> ► Observe the messages in the multifunction display.
 <p data-bbox="57 795 384 826">Fuel reserve warning lamp</p>	<p data-bbox="441 681 1181 707">The yellow fuel reserve warning lamp lights up while driving.</p> <p data-bbox="441 717 1905 749">There has been pressure loss in the fuel system. The fuel filler cap is not closed correctly or the fuel system is leaking.</p> <ul data-bbox="441 759 1627 831" style="list-style-type: none"> ► Close the fuel filler cap. ► If the fuel filler cap was already properly closed: consult a qualified specialist workshop.

Warning/indicator lamp	Possible causes/consequences and ► Solutions
 <p data-bbox="118 300 449 331">Fuel reserve warning lamp</p>	<p data-bbox="500 181 1369 217">The yellow fuel reserve warning lamp is lit while the engine is running.</p> <p data-bbox="500 222 1124 259">The fuel level has dropped into the reserve range.</p> <ul data-bbox="500 264 643 300" style="list-style-type: none"><li data-bbox="500 264 643 300">► Refuel.

Warning/indicator lamp



Coolant warning lamp

Possible causes/consequences and ► Solutions

The red coolant warning lamp is lit while the engine is running.

Possible causes are:

- The temperature sensor is malfunctioning
- The coolant level is too low
- The air supply to the radiator is obstructed
- The radiator fan is defective

If there is an additional warning tone, the coolant temperature has exceeded 248 °F (120 °C).

▲ WARNING Danger of burns when opening the hood

If you open the hood when the engine has overheated or during a fire in the engine compartment, you could come into contact with hot gases or other escaping operating fluids.

- Before opening the hood, allow the engine to cool down.
- In the event of a fire in the engine compartment, keep the hood closed and call the fire service.

- Pull over and stop the vehicle safely and switch off the engine, paying attention to road and traffic conditions. Do not continue driving under any circumstances.
- Observe the messages in the multifunction display.

If the coolant temperature display is at the lower end of the temperature scale:

- Consult a qualified specialist workshop.

Warning/indicator lamp	Possible causes/consequences and ► Solutions
	<p>Otherwise:</p> <ul style="list-style-type: none"><li data-bbox="506 217 1706 248">► Leave the vehicle and keep a safe distance from the vehicle until the engine has cooled down.<li data-bbox="506 259 848 290">► Check the coolant level .<li data-bbox="506 300 1318 331">► Make sure that the air supply to the radiator is not obstructed.<li data-bbox="506 341 1982 409">► Avoiding high loads on the engine, drive on to the nearest qualified specialist workshop. In doing so, ensure that the coolant temperature display remains below 248 °F (120 °C).

Tires

Warning/indicator lamp



Tire pressure monitoring system warning lamp lights up

Possible causes/consequences and ► Solutions

The yellow tire pressure monitoring system warning lamp (pressure loss/malfunction) is lit.
The tire pressure monitoring system has detected tire pressure loss in at least one of the tires.

⚠ WARNING Risk of an accident due to insufficient tire pressure

Tire pressures that are too low pose the following hazards:

- The tires may burst, especially as the load and vehicle speed increase.
- The tires may wear excessively and/or unevenly, which may greatly impair tire traction.
- The driving characteristics, as well as steering and braking, may be greatly impaired.

You could then lose control of the vehicle.

- Observe the recommended tire pressure.
- Adjust the tire pressure if necessary.

- Stop the vehicle, paying attention to road and traffic conditions.
- Check the tire pressure and the tires.

Warning/indicator lamp	Possible causes/consequences and ► Solutions
 <p data-bbox="118 301 429 391">Tire pressure monitoring system warning lamp flashes</p>	<p data-bbox="502 184 1937 246">The yellow tire pressure monitoring system warning lamp (pressure loss/malfunction) flashes for approximately one minute and then remains lit.</p> <p data-bbox="502 260 1177 291">The tire pressure monitoring system is malfunctioning.</p> <div data-bbox="502 311 1984 536"><p data-bbox="519 324 1770 355">▲ WARNING There is a risk of an accident if the tire pressure monitoring system is malfunctioning</p><p data-bbox="523 370 1937 433">If the tire pressure monitoring system is malfunctioning, it is not able to issue a warning if there is pressure loss in one or more of the tires.</p><p data-bbox="523 448 1671 479">Underinflated tires may, for example, impair the driving, steering and braking characteristics.</p><ul data-bbox="523 490 1616 521" style="list-style-type: none">▶ Have the tire pressure monitoring system checked at a qualified specialist workshop.</div> <p data-bbox="502 557 1038 588">► Consult a qualified specialist workshop.</p>

- 1, 2, 3 ...
- 12 V socket**
see Socket (12 V)
- 360° Camera** 184
Care 260
Function 184
Selecting a view 186
- A**
- A/C function**
Activating/deactivating (control panel) 128
- ABS (Anti-lock Braking System)** 155
- Acceleration**
see Kickdown
- Access data**
Setting 234
- Acoustic locking verification signal**
Switching on/off 52
- Active Blind Spot Assist** 193
Activating/deactivating 195
Brake application 194
Function/notes 193
- System limits 193
Towing a trailer 194
- Active Brake Assist** 159
Function/notes 159
Setting 163
- Active Emergency Stop Assist** 172
- Active hood (pedestrian protection)** 251
Method of operation 251
Resetting 251
- Active Lane Change Assist** 172
- Active Lane Keeping Assist** 195
Function 195
Sensitivity (function/notes) 198
Setting the sensitivity 198
Switching on/off 197
System limits 195
Towing a trailer 195
- Adaptive cruise control**
see Distance Pilot DISTRONIC
- Adaptive Highbeam Assist**
Function 116
Switching on/off 117
- Additives** 320
Engine oil 320
Fuel 320
- Additives (engine oil)**
see Additives
- Additives (fuel)**
see Fuel
- Adjusting the balance/fader**
Burmester® surround sound system 249
- Adjusting the sound optimization**
Burmester® surround sound system 249
- ADS PLUS damping system**
see AIR BODY CONTROL
- After-sales service center**
see ASSYST PLUS
- Air bag**
Activation 27
Front air bag 32
Knee air bag 32
Side air bag 32
Window air bag 32
- Air bags**
Installation locations 32

- Overview 32
- Air bags**
 - see Occupant safety
- AIR BODY CONTROL** 174
 - Setting 176
 - Suspension 174
- Air conditioning system**
 - see Climate control
- Air distribution** 127
- Air freshener system**
 - see Fragrance system
- Air suspension**
 - see AIR BODY CONTROL
- Air vents** 131
 - Adjusting (front) 131
 - Adjusting (rear passenger compartment) 131
 - Glove box 131
- Air vents**
 - see Air vents
- Air-recirculation mode** 129
- Airbag**
 - Protection 33
 - Reduced protection 34
- Airflow** 127
- AIRPANEL (Care)** 260
- Alarm**
 - see Panic alarm
- Alarm system**
 - see Protection against theft
- Ambient lighting** 119
- Animals**
 - Pets in the vehicle 50
- Anti-lock braking system**
 - see ABS (Anti-lock Braking System)
- Anti-theft alarm system**
 - Protection against theft 75
- Anti-theft protection**
 - Deactivating the alarm (ATA) 76
 - Immobilizer 75
- Anticipatory occupant protection** 39, 40
- Ashtray**
 - Front center console 107
 - Rear passenger compartment 108
- Assistance graphic**
 - Menu (on-board computer) 203
- Assistance systems**
 - see Driving safety system
- ASSYST PLUS** 250
 - Battery disconnection periods 251
 - Displaying the service due date 250
 - Function/notes 250
 - Regular service work 250
 - Special service requirements 250
- ATA (Anti-Theft Alarm system)**
 - Deactivating the alarm 76
 - Function 75
- ATA (anti-theft alarm system)**
 - see Protection against theft
- ATTENTION ASSIST** 191, 193
 - Activating/deactivating 193
 - Function 191
 - System limitations 191
- Attention assistant**
 - see ATTENTION ASSIST

- Audio 20**
see Multimedia system
- Audio mode**
Activating media mode 238
Connecting USB devices 239
Copyright 237
Information 237
Inserting/removing SD memory card
..... 238
Media search 240
Overview 238
Pause and playback function 239
Selecting a track 239
Selecting playback options 239
Track list 239
- Authorized workshop**
see Qualified specialist workshop
- Automatic car wash (care)** 257
- Automatic distance control**
see Distance Pilot DISTRONIC
- Automatic driving lights** 115
- Automatic engine start (ECO start/
stop function)** 138
- Automatic engine stop (ECO start/
stop function)** 138
- Automatic front passenger air bag
shutoff**
see Front passenger air bag shutoff
- Automatic mirror folding function**
Activating/deactivating 125
- Automatic transmission**
DIRECT SELECT lever 141
Drive program display 140
Drive programs 140
DYNAMIC SELECT switch 140
Engaging drive position 143
Engaging reverse gear 142
Kickdown 144
Manual gear shifting 143
Selecting park position 142
Shifting to neutral 142
Steering wheel gearshift paddles 143
Transmission position display 141
Transmission positions 141
- Automatic transmission**
see Selector lever
- Automatic volume adjustment** 220
- B**
- Bag hook** 102
- BAS (Brake Assist System)** 155
- Battery**
Key 53
- Battery (vehicle)**
Charging 272
Jump-starting 272
Notes 270
- Battery (vehicle)**
see Vehicle battery
- Belt** 28
- Blind Spot Assist** 193
Activating/deactivating 195
Function/notes 193
System limits 193
- Blind Spot Assist**
see Active Blind Spot Assist
- Blower**
see Climate control
- Bluetooth®**
Activating/deactivating 220

- Settings 220
 - Bluetooth® Audio**
 - Activating 242
 - Adjusting the volume 242
 - De-authorizing (de-registering) the device 242
 - Displaying device details 242
 - Information 241
 - Overview 241
 - Searching for and authorizing the device 241
 - Brake Assist System**
 - see BAS (Brake Assist System)
 - Brake fluid**
 - Notes 321
 - Brake force distribution**
 - EBD (Electronic Brake force Distribution) 159
 - Brakes**
 - ABS (Anti-lock Braking System) 155
 - BAS (Brake Assist System) 155
 - Driving tips 136
 - EBD (Electronic Brake force Distribution) 159
 - HOLD function 173
 - Limited braking effect (salt-treated roads) 136
 - New/replaced brake linings/brake discs 136
 - Notes on breaking-in a new vehicle 136
 - Brakes**
 - see Active Brake Assist
 - Braking assistance**
 - see BAS (Brake Assist System)
 - Breakdown** 264
 - Changing a wheel 308
 - Overview of the help functions 12
 - Roadside Assistance 17
 - Tow starting 280
 - Towing away 276
 - Transporting the vehicle 278
 - Burmester® surround sound system** 249
 - Adjusting the balance/fader 249
 - Adjusting the sound optimization 249
 - Calls up the sound menu 249
 - Information 249
 - Setting treble, mid-range and bass 249
 - Switching the surround sound on/off 249
 - Buttons**
 - Steering wheel 200
- C
- California**
 - Important information for private customers and lessees 18
 - Call lists**
 - Calling up the speed dial list 230
 - Deleting speed dial presets 230
 - Displaying details from a list entry 229
 - Making a call 229
 - Overview 229
 - Setting up a speed dial list 230
 - Calls** 226
 - Accepting 226
 - Activating functions during a call 226
 - Calls with several participants 227
 - Declining 226
 - Ending a call 226
 - Incoming call during an existing call 227
 - Making 226

Calls up the sound menu

Burmester® surround sound system 249

Camerasee 360° Camera
see Rear view camera**Car wash**

see Care

Care 262

AIRPANEL 260

Car wash 257

Carpet 262

Display 262

Exterior lighting 260

Genuine wood/trim elements 262

Matte finish 259

Paintwork 259

Plastic trim 262

Power washer 258

Rear view camera/360° Camera 260

Roof lining 262

Seat belts 262

Seat cover 262

Sensors 260

Tailpipes 260

Washing by hand 258

Wheels/rims 260

Windows 260

Wiper blades 260

Cargo compartment cover

Extending/retracting 99

Notes 98

Carpet (Care) 262**Change of address** 17**Change of ownership** 17**Changing a wheel**

Lowering the vehicle 312

Mounting a new wheel 311

Preparation 308

Raising the vehicle 309

Removing a wheel 311

Removing/mounting hub caps 308

Changing hub caps 308**Character entry**

Function/notes 217

Charging

Battery (vehicle) 272

Child safety lock

Rear door 48

Rear side windows 49

Child seat 41

Front passenger seat (notes) 47

Front passenger seat (rearward-facing/forward-facing) 47

LATCH-type (ISOFIX) (installing) 45

LATCH-type (ISOFIX) (notes) 44

Notes 41

Top Tether 46

Child seat safety feature 43**Children**

Child seat safety feature 43

Restraint systems 41

Chock

Storage location 307

Chock

see Wheel chock





Cigarette lighter 108**Cleaning**

















see Care





















Climate control 127















Activating/deactivating 128

- Activating/deactivating the A/C function (control panel) 128
- Activating/deactivating the synchronization function (control panel) 128
- Adjusting air vents 131
- Air distribution settings 128
- Air-recirculation mode 129
- Automatic control 128
- Defrosting the windows 129
- Defrosts the windshield 127
- Dual-zone automatic climate control panel 127
- Filling capacity for PAG oil 324
- Fragrance system 129
- Glove box air vent 131
- Inserting/removing the flacon (fragrance system) 129
- Ionization 129
- Multimedia system overview 127
- Note 127
- Rear air vents 131
- Refrigerant 323
- Refrigerant filling capacity 324
- Sets the airflow 127
- Setting the air distribution 127
- Setting the temperature 127
- Switching the rear window heater on/off 127
- Windshield heater 130
- Cockpit** 4
 - Overview 4
- Combination switch**
 - see Turn signal light
- Combined luggage cover and net**
 - Attaching to the rear seat backrest 100
 - Installing/removing 99
- Computer** 200
- Controller**
 - Operating 212
- Convenience closing** 68
- Convenience opening** 67
- Coolant (engine)**
 - Checking level 255
 - Filling capacity 322
 - Notes 322
- Cooling**
 - see Climate control
- Copyright**
 - Licenses 24
 - Trademarks 24
- Cornering light function** 116
- Cover** 65
- Cross Traffic Alert** 191
- Crosswind Assist**
 - Function/notes 159
- Cruise control** 163
 - Activating 164
 - Calling up a speed 164
 - Deactivating 164
 - Function 163
 - Lever 164
 - Prerequisites 164
 - Selecting 164
 - Setting a speed 164
 - Storing a speed 164
 - System limits 163
- Cup holder** 106
 - Installing/removing (center console) ... 106
 - Rear passenger compartment 107

- Cup holder**
 - see Cup holder
 - Customer Assistance Center (CAC)** 21
 - Customer Relations Department** 21
- D**
- Dashboard**
 - see Cockpit
 - Dashboard lighting** 202
 - Data acquisition**
 - Vehicle 22
 - Data import/export**
 - Function/notes 221
 - Importing/exporting 221
 - PIN protection for data export 222
 - Daytime running lights** 118
 - Activating/deactivating 118
 - Daytime running lights mode**
 - see Daytime running lights
 - Deactivating the alarm (ATA)** 76
 - Declaration of Conformity**
 - Wireless vehicle components 19
 - Definitions (tires and loading)** 301
 - Diagnostics connection** 20
 - Digital Operator's Manual** 14
 - Digital speedometer** 203
 - DIRECT SELECT lever** 141
 - Engaging drive position 143
 - Engaging park position automatically .. 142
 - Engaging reverse gear 142
 - Function 141
 - Selecting park position 142
 - Shifting to neutral 142
 - Display**
 - Care 262
 - Notes (multimedia system) 210
 - Display (multimedia system)**
 - Deactivating 219
 - Settings 218
 - Display (on-board computer)** 201
 - Display message** 326
 - Calling up (on-board computer) 326
 - Notes 326
 - Display messages**
 -  350, 364
 -  365
 -  364
 -  348
 - Active Blind Spot Assist Currently Unavailable See Operator's Manual 347
 - Active Blind Spot Assist Inoperative 347
 - Active Blind Spot Asst. Not Available When Towing a Trailer See Operator's Manual 349
 - Active Brake Assist Functions Currently Limited See Operator's Manual 337
 - Active Brake Assist Functions Limited See Operator's Manual 337
 -  Active Headlamps Inoperative 366
 - Active Hood Malfunction See Operator's Manual 364

Active Lane Keeping Assist Camera View Restricted See Operator's Manual	346	 Auto Lamp Function Inoperative	367	Cruise Control Off	348
Active Lane Keeping Assist Currently Unavailable See Operator's Manual	345	Auxiliary Battery Malfunction	362	 Currently Unavailable See Operator's Manual	327
Active Lane Keeping Assist Inoperative	345	Blind Spot Assist Currently Unavailable See Operator's Manual	346	 Currently Unavailable See Operator's Manual	329
Adaptive Highbeam Assist Camera View Restricted See Operator's Manual	368	Blind Spot Assist Inoperative	347	Distance Pilot Currently Unavailable See Operator's Manual	348
Adaptive Highbeam Assist Currently Unavailable See Operator's Manual	367	Blind Spot Assist Not Available When Towing a Trailer See Operator's Manual	349	Distance Pilot Inoperative	348
Adaptive Highbeam Assist Inoperative	367	 Check Brake Fluid Level	336	Distance Pilot Now Available	347
Apply Brake to Shift from 'P'	360	Check Coolant Level See Operator's Manual	350	 Don't Forget Your Key	360
 ATTENTION ASSIST Inoperative	343	 Check Engine Oil At Next Refueling	353	 Drive More Slowly	345
 ATTENTION ASSIST: Take a Break!	343	 Check Tires	355	Driver's Door Open & Transmission Not in P Risk of Vehicle Rolling Away ..	360
		 Check Washer Fluid	365	 Example: Check Left Low Beam	366
		 Compressor Is Cooling	345	 Example: Front Left Malfunction Service Required	340
		 Coolant Too Hot Stop Vehicle Turn Engine Off	351	 Example: Left Side Curtain Air- bag Malfunction Service Required	340
		Cruise Control Inoperative	349		

- Example: Parking Pilot Parking Canceled 347
-  Example: Rear Left Backrest Not Latched 365
- Front Passenger Airbag Disabled See Operator's Manual 341
- Front Passenger Airbag Enabled See Operator's Manual 342
-  Fuel Level Low 353
-  Gas Cap Loose 354
-  Inoperative See Operator's Manual 328
-  Inoperative See Operator's Manual 330
-  Inoperative See Operator's Manual 331
-  Inoperative 341
-  Key Not Detected (red display message) 359
-  Key Not Detected (white display message) 359
-  Malfunction See Operator's Manual 344
-  Malfunction See Operator's Manual 366
- N Permanently Active Risk of Rolling Away 360
-  Obtain a New Key 358
-  Off 347
- Only Shift to 'P' when Vehicle is Stationary 361
-  Parking Brake See Operator's Manual 333
- Parking Pilot and PARKTRONIC Inoperative See Operator's Manual 349
- Parking Pilot Maneuvering Assistance Restricted See Operator's Manual 349
-  Place the Key in the Marked Space See Operator's Manual 359
-  Please Correct Tire Pressure 354
-  Please Release Parking Brake 332
- PRE-SAFE Impulse Side Inoperative See Operator's Manual 337
- PRE-SAFE Inoperative See Operator's Manual 337
- Radar Sensors Dirty See Operator's Manual 338
-  Replace Key Battery 358
- Reversing Not Possible Service Required 361
-  See Operator's Manual 352
- Service Required Do Not Shift Gears Visit Dealer 361
-  SRS Malfunction Service Required 339
-  Start Engine See Operator's Manual 354

 Steering Malfunction Drive Carefully Service Required 362	Tire Press. Monitor Currently Unavailable 356	Distance Pilot DISTRONIC 165
 Steering Malfunction Increased Physical Effort See Operator's Man- ual 363	Tire Press. Monitor Inoperative 357	Activating 167
 Steering Malfunction Stop Immediately See Operator's Manual ... 363	Tire Pressure Monitor Inoperative No Wheel Sensors 357	Activation conditions 167
Steering Pilot Currently Unavailable See Operator's Manual 348	Tires Overheated 357	Calling up a speed 167
Steering Pilot Inoperative 348	Tires Overheated Decrease Speed 358	Deactivating 167
Stop Vehicle Leave Engine Running	To Deselect P or N, Depress Brake and Start Engine 360	Function 165
Wait Transmission Cooling 362	Transmission Malfunction Stop 361	Lever 167
 Stop Vehicle Leave Engine Run- ning 353	 Turn On the Ignition to Release the Parking Brake 332	Setting a speed 167
 Stop Vehicle See Operator's Manual 352	 Vehicle Operational Switch the Ignition Off Before Exiting 361	Storing a speed 167
 Stop Vehicle Vehicle Too Low 344	 Vehicle Rising Please Wait 343	System limits 165
 Switch Off Lights 367	 Vehicle Rising 343	Distance recorder 203
 Switch On Headlamps 367	 Warning Tire Malfunction 356	DISTRONIC see Distance Pilot DISTRONIC
	 Wheel Sensor(s) Missing 357	Door Locking (emergency key) 59
Distance control see Distance Pilot DISTRONIC		Opening (from inside) 56
		Unlocking (emergency key) 59
		Unlocking (from inside) 56
		Door control panel 10
		DOT, Tire Identification Number (TIN) ... 297
		Drinking and driving 136
		Drive Away Assist 190

- DRIVE PILOT** 171
 Function 171
- Drive position**
 Selecting 143
- Drive program display** 140
- Drive programs** 140
- Driver's seat**
 see Seat
- Driving light**
 see Automatic driving lights
- Driving safety system** 154
 ABS (Anti-lock Braking System) 155
 Active Brake Assist 159
 BAS (Brake Assist System) 155
 EBD (Electronic Brake force Distribution) 159
 ESP® (Electronic Stability Program)
 Crosswind Assist 159
 Overview 154
 Radar sensors 154
 Responsibility 154
- Driving safety system**
 see ESP® (Electronic Stability Program)
- Driving system**
 see 360° Camera
 see Active Blind Spot Assist
 see Active Lane Keeping Assist
 see AIR BODY CONTROL
 see ATTENTION ASSIST
 see Blind Spot Assist
 see Cruise control
 see Distance Pilot DISTRONIC
 see DRIVE PILOT
 see Driving safety system
 see HOLD function
 see Parking Assist PARKTRONIC
 see Parking Pilot
 see Rear view camera
 see Steering Pilot
- Driving tips**
 Drinking and driving 136
 General driving tips 136
 Notes on breaking-in a new vehicle 136
- Drowsiness detection**
 see ATTENTION ASSIST
- Drowsiness warning**
 see ATTENTION ASSIST
- Dynamic handling control system**
 see ESP® (Electronic Stability Program)
- DYNAMIC SELECT**
 Configuring drive program I 141
 Drive program display 140
 Drive programs 140
 Function 140
 Operating (DYNAMIC SELECT switch)
 140
- E**
- E-mails**
 see Messages
- E10** 319
- Easy entry feature**
 Operation/notes 90
 Setting 91
- Easy exit feature**
 Operation/notes 90
 Setting 91
- EASY-PACK load-securing kit** 103
 Notes 103
 Tensioning the luggage holder 104
 Tensioning the telescopic rod 104

EBD (Electronic Brake force Distribution)			
Function/notes	159		
ECO display			
Function	139		
Resetting	204		
ECO start/stop function	138, 139		
Automatic engine start	138		
Automatic engine stop	138		
Operation	138		
Switching off/on	139		
Electric parking brake	151, 152, 153		
Applying automatically	151		
Applying or releasing manually	153		
Emergency braking	153		
Releasing automatically	152		
Electric parking brake			
see Parking			
Electrical fuses			
see Fuses			
Electronic Stability Program			
see ESP® (Electronic Stability Program)			
Electronics	314		
Emergency			
Overview of the help functions	12		
Safety vest	264		
Emergency braking	153		
Emergency call system			
Mercedes-Benz mbrace® (USA only) ...	232		
Emergency engine start	280		
Emergency key			
Inserting/removing	53		
Locking a door	59		
Unlocking a door	59		
Unlocking the tailgate	64		
Emergency operation mode			
Starting vehicle	135		
Emergency Tensioning Devices			
Activation	27		
Energy consumption			
Key	52		
Engine			
ECO start/stop function	138		
Engine number	316		
Jump-starting	272		
Starting (emergency operation mode)	135		
Starting (smartphone)	134		
Starting (start/stop button)	134		
Switching off (start/stop button)	147		
Engine hood			
Opening/closing	251		
Engine number	316		
Engine oil	254		
Additives	320		
Capacity	321		
Checking the oil level using the oil dipstick	254		
MB-Freigabe or MB-Approval	321		
Topping up	254		
Entering characters			
On the controller	217		
On the touchpad	218		
ESC (Electronic Stability Control)			
see ESP® (Electronic Stability Program)			
ESP® (Electronic Stability Program)	156		
Activating/deactivating	159		
Crosswind Assist	159		
Function/notes	156		

Exterior lighting

Care 260

Exterior lighting

see Lights

Eyeglasses box 94**F****Fatigue warning**

see ATTENTION ASSIST

Favorites

Adding 216

Calling up 215

Deleting 216

Moving 216

Overview 215

Renaming 216

Flacon

Inserting/removing 129

Flat tire

Changing a wheel 308

MOExtended tires 265

Notes 264

TIREFIT kit 266

Flat tire

see Breakdown

Floor mats 113**Folding bench seat** 86

Folding back 88

Folding out 86

Installing and removing the seat

cushion 87

Notes 86

Fragrance

see Fragrance system

Fragrance system 129

Activating/deactivating 129

Adjusting the fragrance intensity 129

Inserting/removing the flacon 129

Frequencies

Two-way radio 315

Frequency band

Dial (on-board computer) 206

Front air bag 32**Front passenger air bag shutoff** 35

PASSENGER AIR BAG indicator lamp 37

Points to remember when the front

passenger seat is occupied 35

Status display 37

System self-test 37

Front passenger air bag shutoff

see Occupant safety

Front passenger seat

Adjusting from the driver's seat 81

Front passenger seat

see Seat

Fuel 320

Additives 320

Consumption 320

E10 319

Gasoline 319

Quality (gasoline) 319

Refueling 145

Reserve fuel level 320

Sulfur content 319

Tank capacity 320

Fuel consumption

On-board computer 203

Function seat

see Door control panel

- Fuse insert**
see Fuses
- Fuses** 280
Assignment diagram 280
Before changing 280
Cockpit fuse box 282
Fuse box in the cargo compartment 283
Fuse box in the engine compartment .. 281
Fuse box in the front-passenger foot-
well 282
Notes 280
- G**
- Garage door opener**
Clearing the memory 151
Opening or closing the garage door 150
Programming buttons 148
Radio equipment approval number 151
Resolving problems 150
Synchronizing the rolling code 149
- Garmin® MAP PILOT navigation mod-
ule**
Activating 223
Overview 223
- Gasoline** 319
- Gearshift paddles**
see Steering wheel gearshift paddles
- Gearshift recommendation** 143
- Genuine parts** 15
- Genuine wood (Care)** 262
- Glide mode** 144
- Glove box**
Air vent 131
- Glove compartment**
Locking/unlocking 94
- H**
- Handbrake**
see Electric parking brake
- Handling characteristics (unusual)** 284
- HANDS-FREE ACCESS** 63
- HANDS-FREE ACCESS**
see Opening the tailgate using your foot
- Hazard warning lights** 116
- Head restraint** 82
Front (adjusting manually) 82
Front (luxury head restraint) 83
Rear (lowering from the front) 84
Rear passenger compartment
(adjusting) 84
Rear passenger compartment
(removing/installing) 84
- Head-up display**
Activating/deactivating 209
Adjusting brightness (on-board com-
puter) 208
Adjusting display elements (on-board
computer) 208
Adjusting the position (on-board
computer) 208
Function 208
Menu (on-board computer) 208
Using the memory function 91
- Head-up Display**
see Menu (on-board computer)
- Head-up Display menu**
see On-board computer

- Heating**
see Climate control
- High beam**
Activating/deactivating 115
- High-beam flasher** 115
- High-beam headlamps**
Adaptive Highbeam Assist 116
- High-pressure cleaning equipment (care)** 258
- Hill start assist** 173
- HOLD function** 173
Activating/deactivating 173
Function/notes 173
- Hood**
Function (active hood) 251
Resetting (active hood) 251
- I**
- Identification plate**
Engine 316
Refrigerant 323
Vehicle 316
- Ignition**
Switching on (start/stop button) 133
- Ignition key** 51
- Immobilizer** 75
- Inattentiveness assistant**
see ATTENTION ASSIST
- Indicator lamp**
see Warning/indicator lamps
- Individual drive program**
Configuring 141
Selecting 140
- Information**
Satellite radio 245
- Instrument cluster** 368
- Instrument cluster**
see Instrument Display
- Instrument Display** 199
Adjusting the lighting 202
Function/notes 199
Warning and indicator lamps (overview) .. 6
Warning/indicator lamps 368
- Instrument Display**
see Display (on-board computer)
see Instrument cluster
- Instrument lighting** 202
- Instrument lighting**
see Dashboard lighting
- Intelligent Light System**
Cornering light function 116
- Interior lighting** 118
Ambient lighting 119
Setting 118
Switch-off delay time 119
- Interior lighting**
see Interior lighting
see Lighting
see Lights
- Internet**
Deleting favorites 236
Deleting history 236
Setting favorites 236
- Internet connection**
Canceling permission 234
Ending 235

- Establishing 235
- Mobile phone details 235
- Setting access data 234
- Setting up 234
- Ionization** 129
- J**
- Jack**
 - Storage location 307
- Jump-start connection** 272
- Jump-starting** 272
- Jump-starting**
 - see Jump-start connection
- K**
- Key**
 - Battery 53
 - Energy consumption 52
- KEYLESS-GO**
 - Locking the vehicle 56
 - Problem 57
 - Unlocking setting 52
 - Unlocking the vehicle 56
- Kickdown** 144
 - Using 144
- Knee air bag** 32
- L**
- Labeling (tires)**
 - see Tire labeling
- Laden** 102
 - Bag hook 102
 - Definitions 301
 - Roof rack 106
 - Stowage space underneath the cargo compartment floor 105
 - Tie-down eyes 102
- Laden**
 - see EASY-PACK load-securing kit
- Lamp**
 - see Interior lighting
- Lamp (Instrument Display)**
 - see Warning/indicator lamps
- Lane Keeping Assist**
 - see Active Lane Keeping Assist
- Language**
 - Notes 221
 - Setting 221
- LATCH-type (ISOFIX) child seat attachment**
 - Installing 45
 - Notes 44
- Level control system**
 - see AIR BODY CONTROL
- Light switch**
 - Overview 114
- Lighting** 118
- Lighting**
 - see Lights
- Lights** 114, 118
 - Adaptive Highbeam Assist 116
 - Adjusting the instrument lighting 202
 - Automatic driving lights 115
 - Combination switch 115
 - Cornering light function 116
 - Hazard warning lights 116
 - High beam 115
 - High-beam flasher 115
 - Light switch 114

- Low beam 114
 - Parking lights 114
 - Rear fog light 115
 - Responsibility for lighting systems 114
 - Standing lights 114
 - Turn signal light 115
 - Limited Warranty**
 - Vehicle 22
 - Limiting the opening angle (tailgate)** 64
 - Load index (tires)** 299
 - Load rating (tires)** 299
 - Loading guidelines** 92
 - Loading information table** 291
 - Loads**
 - Securing 92
 - Locator lighting**
 - Activating/deactivating 118
 - Locking** 51
 - Locking/unlocking** 56, 59
 - Low beam**
 - Switching on/off 114
 - Lowering**
 - Vehicle 312
 - Lubricant additives**
 - see Additives
 - Luggage**
 - Securing 92
 - Lumbar support**
 - see Lumbar support (4-way)
 - Lumbar support (4-way)** 82
- M**
- Maintenance**
 - Vehicle 17
 - Maintenance**
 - see ASSYST PLUS
 - Making a call via the overhead control panel**
 - Mercedes-Benz mbrace® (USA only) ... 231
 - Malfunction**
 - Restraint system 27
 - Malfunction message**
 - see Display message
 - Matte finish (cleaning instructions)** 259
 - Maximum load rating** 298
 - Maximum permissible load**
 - Calculation example 293
 - Determining 292
 - Maximum tire pressures** 298
 - Media**
 - Menu (on-board computer) 206
 - Searching 240
 - Media Interface**
 - Activating 240
 - Information 240
 - Overview 240
 - Media mode**
 - Activating 238
 - Media playback**
 - Operating (on-board computer) 206
 - Media search**
 - Starting 240
 - Media source**
 - Dial (on-board computer) 206

Memory function

Head-up Display – Calling up saved settings	91
Head-up Display – Saving settings	91
Operating	91
Outside mirror – Calling up saved settings	91
Outside mirror – Saving settings	91
Seat – Calling up saved settings	91
Seat – Saving settings	91
Steering wheel – Calling up saved settings	91
Steering wheel – Saving settings	91
Menu (on-board computer)	208
Assistance graphic	203
Media	206
Navigation	205
Overview	200
Radio	206
Service	202
Telephone	207
Trip	203
Mercedes-Benz Apps	
Calling up	235

Mercedes-Benz mbrace® (USA only)

Emergency call system	232
Making a call via the overhead control panel	231
MB Info call	233
Roadside Assistance call	233
Transferred data	233

Mercedes-Benz service center

see Qualified specialist workshop

Message (multifunction display)

see Display message

Message memory 326**Messages** 230

Making a call	231
Notes	230
Reading	231
Settings	230

Mirrors

see Outside mirror

see Outside mirrors

Mobile phone 207

Canceling permission for Internet connection	234
Wireless charging	112

Mobile phone

see Telephone

Model type 316**MOExtended tires** 265**Multifunction display (on-board computer)** 201**Multifunction steering wheel**

Overview of buttons 200

Multifunction steering wheel

see Steering wheel

Multimedia system 210, 218

Activating/deactivating standby mode	154
Calling up menus	214
Central controls	210
Configuring display settings	218
Main functions	214
Overview	210
Restoring the factory settings	222
Switching the sound on/off	217

N	
Navigation	
Menu (on-board computer)	205
Navigation messages	
On-board computer	205
Neutral	
Selecting	142
Noise	
Wheels and tires	284
Notes on breaking-in a new vehicle	136

O	
Occupant safety	26, 28, 32, 35, 39, 40
Pets in the vehicle	50
Occupant safety	
see Child seat	
Odometer	
see Total distance	
Oil	
see Engine oil	
On-board computer	208
Assistance graphic menu	203

Displaying the service due date	250
Media menu	206
Menus	200
Multifunction display	201
Navigation system menu	205
Operating	200
Radio menu	206
Service menu	202
Telephone menu	207
Trip menu	203

On-board computer	
see Computer	
see Operating system	
On-board diagnostics interface	
see Diagnostics connection	
On-board electronics	
Notes	314
Two-way radios	314
On-board electronics	
see Electronics	
Opening the tailgate using your foot	63
Operating fluids	
Additives (fuel)	320
Brake fluid	321

Coolant (engine)	322
Engine oil	320
Fuel (gasoline)	319
Notes	318
Refrigerant (air conditioning system) ...	323
Windshield washer fluid	322
Operating safety	
Declaration of conformity (wireless vehicle components)	19
Information	18
Operating system	200
Operator's Manual	
Vehicle equipment	16
Operator's Manual (digital)	14
Outside mirror	124
Parking position	124
Outside mirrors	123, 124
Anti-glare mode (automatic)	124
Automatic mirror folding function	125
Folding in/out	123
Setting	123
Using the memory function	91
Overhead control panel	8

Overview

Garmin® MAP PILOT navigation module	223
Phone book	227
Satellite radio	246

P

Paint code	316
Paintwork (cleaning instructions)	259
Panic alarm	52
Activating/deactivating	52
Panoramic sliding sunroof see Sliding sunroof	
Park position Selecting	142
Selecting automatically	142
Parking	151, 153
Parking aid see Parking Assist PARKTRONIC	
Parking Assist PARKTRONIC	178
Activating	180
Adjusting warning tones	180
Deactivating	180

Function	178
Side impact protection	179
System limitations	178

Parking assistance systems

 see Parking Pilot

Parking brake

 see Electric parking brake

Parking lights

114

Parking Pilot

186

Cross Traffic Alert	191
Drive Away Assist	190
Exiting a parking space	189
Function	186
Maneuvering assistance	191
Parking	188
System limits	186

Parking position

Outside mirror	124
Passenger outside mirror – storing using the memory button	125

Payload

Calculation example	293
Determining the maximum	292

Pedestrian protection

 see Active hood (pedestrian protection)

Perfume

 see Fragrance system

Perfume vial

 see Fragrance system

Period out of use

Activating/deactivating standby mode	154
---	-----

Permitted towing methods

275

Pets in the vehicle

50

Phone book

Deleting a contact	229
Display and sorting criteria	228
Downloading mobile phone contacts ..	228
Importing contacts	228
Overview	227
Saving a contact	228
Searching for a contact	228

PIN protection for data export

222

Plastic trim (Care)

262

Playback options

Selecting	239
-----------------	-----

Power supply

Switching on (start/stop button) 133

PRE-SAFE® (anticipatory occupant protection)

Function 39

PRE-SAFE® Sound 39

Reversing measures 40

PRE-SAFE® (anticipatory occupant protection)

see Anticipatory occupant protection

see Occupant safety

see Preventative occupant protection system

PRE-SAFE® Impulse Side

Activation 27

Function 40

PRE-SAFE® Impulse Side

see Anticipatory occupant protection

see Occupant safety

PRE-SAFE® PLUS (anticipatory occupant protection plus)

Function 40

Reversing measures 40

PRE-SAFE® PLUS (anticipatory occupant protection plus)

see Anticipatory occupant protection

see Occupant safety

Presets menu view

Activating/deactivating 244

Preventative occupant protection system

..... 39

Protection against theft

ATA (anti-theft alarm system) 75

Protection of the environment

Notes 15

Q**QR code**

Rescue card 22

Qualified specialist workshop 21**R****Radar sensors** 154**Radiator shutters**

see AIRPANEL (Care)

Radio

Activating 243

Activating/deactivating the presets

view 244

Calling up the station list 244

Delete station 244

Displaying information 245

Displaying the artist and track 245

Editing station presets 244

Menu (on-board computer) 206

Moving stations 244

Overview 243

Searching for stations 243

Setting a station 243

Setting the frequency band 243

Storing stations 244

Switching HD radio on/off 243

Tagging music tracks 245

To display radio text 245

Radio station list

Calling up 244

Radio stations

Dial (on-board computer) 206

Rain closing function

Sliding sunroof 72

- Range**
 Displaying 203
- Reading lamp**
 see Interior lighting
- Rear door (child safety lock)** 48
- Rear fog light** 115
- Rear seat**
 see Seat
- Rear view camera** 181
 Care 260
 Function 181
- Rear window**
 Replacing the wiper blade 122
- Rear window heater** 127
- Rear window wiper**
 Activating/deactivating 120
- Rear-view mirror**
 see Outside mirrors
- Refrigerant (air conditioning system)**
 Notes 323
- Refueling**
 Refueling the vehicle 145
- Reporting malfunctions relevant to safety** 21
- Rescue card** 22
- Reserve**
 Fuel 320
- Reset function (multimedia system)** 222
- Restoring (factory settings)**
 see Reset function (multimedia system)
- Restraint system**
 Children 41
 Function in an accident 27
 Functionality 27
 Malfunction 27
 Protection 26
 Reduced protection 26
 System self-test 27
 Warning lamp 27
- Restraint system**
 see Occupant safety
- Reverse gear**
 Selecting 142
- Reversing camera**
 Opening the camera cover 184
- Reversing camera (Parking Pilot)**
 Opening the camera cover 186
- RF transmitters**
 see Two-way radios
- Rims (Care)** 260
- Roadside Assistance** 17
- Roll away protection**
 see HOLD function
- Roller sunblind**
 Side windows 65
- Roller sunblind**
 see Cover
- Roof lining (care)** 262
- Roof load** 325
- Roof rack** 106
- Run-flat characteristics**
 MOExtended tires 265

S

Safety

see Child seat

- Safety net**
 - Attaching 101
- Safety systems**
 - see Driving safety system
- Safety vest** 264
- Satellite radio**
 - Activating 246
 - Displaying channel information 248
 - Displaying service information 248
 - Information 245
 - Music and sport alerts function 247
 - Overview 246
 - Registering 246
 - Restrictions 246
 - Saving a channel 247
 - Selecting a category 246
 - Selecting a channel 247
 - Setting the music and sport alerts 247
- SD memory card**
 - Inserting/removing 238
- Seat** 78, 95
 - 4-way lumbar support 82
 - Adjusting (electrically) 81
 - Adjusting (manually and electrically) 78
 - Adjusting (Seat Comfort) 80
 - Adjusting the seat backrest angle (rear passenger compartment) 98
 - Backrest (rear) folding forward 95
 - Correct driver's seat position 77
 - Folding back the backrest (rear passenger compartment) 97
 - Locking the backrest (rear passenger compartment) 97
 - Setting options 10
 - Using the memory function 91
- Seat**
 - see Folding bench seat
 - see Head restraint
- Seat belt**
 - Activating/deactivating seat belt adjustment 32
 - Seat belt adjustment (function) 31
- Seat belt adjustment**
 - Activating/deactivating 32
 - Function 31
- Seat belt warning**
 - see Seat belts
- Seat belts** 32
 - Adjusting the height 31
 - Care 262
 - Fastening 31
 - Protection 28
 - Reduced protection 29
 - Releasing 32
 - Warning lamp 32
- Seat belts**
 - see Belt
 - see Occupant safety
- Seat cover (Care)** 262
- Seat heater**
 - Switching on/off 84
- Seat ventilation**
 - Switching on/off 85
- Selecting a gear**
 - see Shifting gears
- Selector lever** 141
- Selector lever**
 - see DIRECT SELECT lever
- Sensors (Care)** 260

- Service**
 - Menu (on-board computer) 202
- Service center**
 - see Qualified specialist workshop
- Service interval display**
 - see ASSYST PLUS
- Setting a speed**
 - see Cruise control
- Setting Daylight Saving Time (Summer)** 219
- Setting the date format** 219
- Setting the distance unit and temperature unit** 221
- Settings**
 - Messages 230
- Shifting gears** 143
 - Gearshift recommendation 143
 - Manually 143
- Short text messages**
 - see Messages
- Side air bag** 32
- Side impact protection** 179
- Side windows**
 - Child safety lock in the rear passenger compartment 49
 - Closing 66
 - Closing with the SmartKey 68
 - Convenience closing 67
 - Convenience opening 67
 - Opening 66
 - Opening with the SmartKey 67
 - Problem 68
 - Roller sunblind 65
- Side windows**
 - see Window lifter
 - see Windows
- Size designation (tires)** 299
- Skid chains** 285
- Sliding sunroof** 70
 - Automatic functions 72
 - Closing 70
 - Closing with the SmartKey 68
 - Opening 70
 - Opening with the SmartKey 67
 - Problem 73
 - Rain closing function 72
- SmartKey** 51
 - Emergency key 53
 - Key ring attachment 53
 - Overview 51
 - Panic alarm 52
 - Problem 54
 - Unlocking setting 52
- SmartKey**
 - see Ignition key
 - see Locking
 - see Vehicle key
- Smartphone**
 - Starting vehicle 134
- Smartphone**
 - see Telephone
- Snow chains** 285
 - see Skid chains
- Socket (12 V)** 109
 - Cargo compartment 110
 - Front center console 109
 - Rear passenger compartment 109

- Socket (115 V)**
 - Rear passenger compartment 109
- Sound**
 - PRE-SAFE® Sound 39
- Sound**
 - see Burmester® surround sound system
 - see Sound settings
- Sound settings** 248
 - Adjusting treble, mid and bass 248
 - Information 248
- Speed dial list**
 - Calling up 230
 - Deleting speed dial presets 230
 - Setting up 230
- Speed limit for winter tires**
 - Setting 165
- Speed rating (tires)** 299
- Speedometer**
 - Digital 203
- Standby mode**
 - Activating/deactivating 154
 - Function 153
- Standing lights** 114
- Start/Stop button**
 - Starting vehicle 134
 - Switching off the vehicle 147
 - Switching on the power supply or ignition 133
- Start/stop function**
 - see ECO start/stop function
- Starting the engine**
 - see Vehicle
- Starting-off aid**
 - see Hill start assist
- Station**
 - Deleting 244
 - Moving 244
 - Searching 243
 - Setting 243
 - Storing 244
- Station presets**
 - Editing 244
- Steering Pilot** 171
 - Activating/deactivating 173
 - Active Emergency Stop Assist 172
 - Active Lane Change Assist 172
 - Function 171
- System limits** 171
- Steering wheel** 200
 - Adjusting (electrically) 90
 - Adjusting (manually) 89
 - Buttons 200
 - Steering wheel heater 90
 - Using the memory function 91
- Steering wheel gearshift paddles** 143
- Steering wheel heater**
 - Activating/deactivating 90
- Stowage areas**
 - see Laden
 - see Stowage compartment
- Stowage compartment** 94
 - Armrest 94
 - Center console 94
 - Door 94
 - Eyeglasses box 94
 - Glove box 94
 - Rear armrest 94
- Stowage compartments**
 - see Laden
 - see Stowage compartment

- Stowage space underneath the cargo compartment floor** 105
- Sulfur content** 319
- Sun visor**
Operating 125
- Surround View**
see 360° Camera
- Suspension**
Setting the suspension level 176
- Suspension**
see AIR BODY CONTROL
- Suspension level**
Setting 176
- Switch-off delay time**
Exterior 118
Interior 119
- Switching the surround sound on/off**
Burmester® surround sound system 249
- Synchronization function**
Activating/deactivating (control panel) 128
- System settings**
Automatic volume adjustment 220
Language 221
Notes on language selection 221
Reset function (multimedia system) 222
Setting the distance unit and temperature unit 221
- System settings**
see Multimedia system
- T**
- Tailgate** 59
Closing 61
Emergency release from the inside 65
HANDS-FREE ACCESS 63
Limiting the opening angle 64
Opening 59
Opening dimensions 324
Unlocking (emergency key) 64
- Tailgate**
see Locking/unlocking
- Tailpipes (Care)** 260
- Tank capacity**
Fuel 320
- Reserve (fuel) 320
- Technical data**
Information 314
Tire pressure monitoring system 291
Vehicle identification plate 316
- Telephone** 224
Activating functions during a call 226
Calls with several participants 227
Disconnecting the mobile phone 225
Incoming call during an existing call 227
Menu (on-board computer) 207
Notes 224
Reception and transmission volume 226
Switching mobile phones 225
Telephone menu overview 224
Telephone operation 226
Wireless charging (mobile phone) 112
- Telephone**
see Mobile phone
- Telephone number**
Dialing (on-board computer) 207
- Temperature** 127
- Temperature grade** 296

- Text messages**
see Messages
- Through-loading feature**
see Seat
- Tie-down eyes** 102
- Time**
Manual time setting 220
Setting Daylight Saving Time (Summer) 219
Setting the time and date automatically 219
Setting the time zone 219
Setting the time/date format 219
- TIN (Tire Identification Number)** 297
- Tire and Loading Information placard** ... 291
- Tire characteristics** 299
- Tire inflation compressor**
see TIREFIT kit
- Tire information table** 291
- Tire labeling** 296
Characteristics 299
DOT, Tire Identification Number (TIN) 297
Load index 299
Load rating 299
Maximum tire load 298
Maximum tire pressure 298
Overview 296
Speed rating 299
Temperature grade 296
Tire Quality Grading 296
Tire size designation 299
Traction grade 296
Tread wear grade 296
- Tire load (maximum)** 298
- Tire pressure** 266
Checking (manually) 288
Checking (tire pressure monitoring system) 290
Maximum 298
Notes 285
Restarting the tire pressure monitoring system 291
Tire pressure monitoring system (function) 289
Tire pressure table 287
- Tire pressure monitoring system**
Checking the tire pressure 290
- Function 289
Restarting 291
Technical data 291
- Tire pressure table** 287
- Tire Quality Grading** 296
- Tire tread** 284
- Tire-change tool kit**
Overview 307
- TIREFIT kit** 266
Storage location 266
Using 266
- TIREFIT kit**
see Tire pressure
- Tires**
Changing 308
Changing hub caps 308
Characteristics 299
Checking 284
Checking the tire pressure (manually) 288
Checking the tire pressure (tire pressure monitoring system) 290
Definitions 301

DOT, Tire Identification Number (TIN)	297	Tire Quality Grading	296	Reading the handwriting recognition aloud	214
Flat tire	264	Tire size designation	299	Selecting a station and track	214
Load index	299	TIREFIT kit	266	Selecting an input language	214
Load rating	299	Traction grade	296	Tow starting	280
Maximum tire load	298	Tread wear grade	296	Towing a trailer	
Maximum tire pressure	298	Unusual handling characteristics	284	Active Blind Spot Assist	194
MOExtended tires	265	To raise		Active Lane Keeping Assist	195
Mounting	311	Vehicle	309	Towing away	276
Noise	284	Tone settings		Towing eye	
Notes on Installing	304	Adjusting the balance/fader	249	Installing	280
Overview of tire labeling	296	Calling up the sound menu	248	Storage location	279
Removing	311	Tool		Towing methods	275
Replacing	304	see Vehicle tool kit		Track	
Restarting the tire pressure monitor- ing system	291	Top Tether	46	Selecting (audio mode)	239
Selection	304	Total distance	203	Traction grade	296
Snow chains	285	Displaying	203	Transmission position display	141
Speed rating	299	Touch Control		Transporting	
Storing	307	On-board computer	200	Vehicle	278
Temperature grade	296	Operating	211	Tread wear grade	296
Tire and Loading Information placard ..	291	Setting the sensitivity	212	Trim element (Care)	262
Tire pressure (Notes)	285	Touchpad			
Tire pressure monitoring system (function)	289	Activating/deactivating	212		
Tire pressure table	287	Operating	213		

- | | | | |
|-------------------------------------|-----|--|----------|
| Trip | | | |
| Menu (on-board computer) | 203 | | |
| Trip computer | | | |
| Displaying | 203 | | |
| Resetting | 204 | | |
| Trip distance | | | |
| Displaying | 203 | | |
| Resetting | 204 | | |
| Trip distance | | | |
| see Distance recorder | | | |
| see Trip meter | | | |
| Trip meter | 203 | | |
| Trunk lid | | | |
| see Tailgate | | | |
| Trunk load | 325 | | |
| Turn signal indicator | | | |
| see Turn signal light | | | |
| Turn signal light | 115 | | |
| Activating/deactivating | 115 | | |
| Two-way radios | 314 | | |
| Frequencies | 315 | | |
| Notes on installation | 314 | | |
| Transmission output (maximum) | 315 | | |
| | | U | |
| | | Unlocking setting | 52 |
| | | USB devices | |
| | | Connecting | 239 |
| | | Using the telephone | |
| | | see Calls | |
| | | V | |
| | | Vehicle | 134, 135 |
| | | Activating/deactivating standby mode | 154 |
| | | Correct use | 21 |
| | | Data acquisition | 22 |
| | | Diagnostics connection | 20 |
| | | Equipment | 16 |
| | | Limited Warranty | 22 |
| | | Locking (automatically) | 58 |
| | | Locking (from inside) | 56 |
| | | Locking (KEYLESS-GO) | 56 |
| | | Locking (mechanical key) | 58 |
| | | Lowering | 312 |
| | | Maintenance | 17 |
| | | Parking | 153 |
| | | Problem notification | 21 |
| | | QR code rescue card | 22 |
| | | Qualified specialist workshop | 21 |
| | | Raising | 309 |
| | | Starting (emergency operation mode) | 135 |
| | | Starting (smartphone) | 134 |
| | | Starting (start/stop button) | 134 |
| | | Switching off (start/stop button) | 147 |
| | | Unlocking (from inside) | 56 |
| | | Unlocking (KEYLESS-GO) | 56 |
| | | Ventilating (convenience opening) | 67 |
| | | Vehicle | |
| | | see Locking/unlocking | |
| | | Vehicle battery | 270 |
| | | Vehicle data | |
| | | Roof load | 325 |
| | | Trunk load | 325 |
| | | Turning radius | 324 |
| | | Vehicle height | 324 |
| | | Vehicle length | 324 |
| | | Vehicle width | 324 |
| | | Wheelbase | 324 |
| | | Vehicle dimensions | 324 |

Vehicle identification number

see VIN

Vehicle identification plate

Paint code 316

VIN 316

Vehicle identification plate

see Model type

Vehicle interior

Cooling or heating (smartphone) 134

Vehicle key 51**Vehicle key**

see SmartKey

Vehicle maintenance

see ASSYST PLUS

Vehicle operation

Outside the USA or Canada 17

Vehicle tool kit 266

TIREFIT kit 266

Towing eye 279

Ventilating

Convenience opening 67

Ventilation

see Climate control

Vents

see Air vents

VIN 316

Identification plate 316

Seat 316

Windshield 316

Visibility

Defrosting the windows 129

Windshield heater 130

W**Warning lamp**

see Warning/indicator lamps

Warning system

see Protection against theft

Warning/indicator lamp ABS warning lamp 372 BRAKE Brake warning lamp (USA) 370 Brakes warning lamp (Canada) 370 Coolant warning lamp 382 Distance warning lamp 378 Electrical malfunction warning

lamp 380

 Engine diagnosis warning lamp ... 380 ESP® OFF warning lamp 374 ESP® warning lamp flashes 372 ESP® warning lamp lights up 373 Fuel reserve warning lamp .. 380, 381 Power steering system warning

lamp 379

 RBS RBS warning lamp (USA/CND) ... 369 Red indicator lamp, electric

parking brake applied (Canada only) ... 375

 PARK Red indicator lamp, electric



parking brake applied (USA only) 375

 Restraint system warning lamp 376 Seat belt warning lamp flashes ... 377 Seat belt warning lamp lights

up 377

 Tire pressure monitoring sys-

tem warning lamp flashes 385

-  Tire pressure monitoring system warning lamp lights up 384
-  Yellow electric parking brake indicator lamp is malfunctioning 375
- Warning/indicator lamps** 368
 - Instrument Display (overview) 6
 - Overview 368
 - PASSENGER AIR BAG 37
- Warranty** 22
- Washer fluid**
 - see Windshield washer fluid
- Washing by hand (care)** 258
- Web browser**
 - Calling up a website 235
 - Calling up options 236
 - Calling up settings 236
 - Closing 237
 - Deleting Internet favorites 236
 - Deleting Internet history 236
 - Overview 235
 - Setting Internet favorites 236
- Website**
 - Calling up 235
- Wheel chock** 307
- Wheel rotation** 306
- Wheels**
 - Care 260
 - Changing 308
 - Changing hub caps 308
 - Checking 284
 - Checking the tire pressure (manually) 288
 - Checking the tire pressure (tire pressure monitoring system) 290
 - Definitions 301
 - DOT, Tire Identification Number (TIN) 297
 - Flat tire 264
 - Load index 299
 - Load rating 299
 - Maximum tire load 298
 - Maximum tire pressure 298
 - MOExtended tires 265
 - Mounting 311
 - Noise 284
 - Notes on installing 304
 - Overview of tire labeling 296
 - Removing 311
- Replacing 304
- Restarting the tire pressure monitoring system 291
- Rotating 306
- Selection 304
- Snow chains 285
- Speed rating 299
- Storing 307
- Temperature grade 296
- Tire and Loading Information placard .. 291
- Tire characteristics 299
- Tire pressure (Notes) 285
- Tire pressure monitoring system (function) 289
- Tire pressure table 287
- Tire Quality Grading 296
- Tire size designation 299
- TIREFIT kit 266
- Traction grade 296
- Tread wear grade 296
- Unusual handling characteristics 284
- Window air bag** 32
- Window lifter** 66
- Windows** 66
 - Closing 66

- Opening 66
- Windows (Care)** 260
- Windshield**
 - Defrosting 127
 - Infrared reflective 126
 - Replacing the wiper blades 120
- Windshield heater** 130
- Windshield heating**
 - see Windshield heater
- Windshield washer fluid** 322
 - Notes 322
- Windshield washer system**
 - Refilling 256
- Windshield wipers**
 - Activating/deactivating 119
 - Replacing the wiper blades 120
- Winter operation**
 - Snow chains 285
- Winter tires**
 - Setting the permanent speed limit 165
- Wiper blades**
 - Care 260
 - Changing 120
- Wireless charging**
 - Function/notes 111
 - Mobile phone 112
- Wireless vehicle components**
 - Declaration of Conformity 19
- Workshop**
 - see Qualified specialist workshop

