



# S-Class

Operator's Manual

S-Class Operator's Manual



2225842905

Order no. 6515 2608 13 Part no. 222 584 29 05 Edition C 2016



Mercedes-Benz

## Symbols

Registered trademarks:

- Bluetooth® is a registered trademark of Bluetooth SIG Inc.
- DTS™ is a registered trademark of DTS, Inc.
- Dolby® and MLP™ are registered trademarks of DOLBY Laboratories.
- BabySmart™, ESP® and PRE-SAFE® are registered trademarks of Daimler AG.
- HomeLink® is a registered trademark of Johnson Controls.
- iPod® and iTunes® are registered trademarks of Apple Inc.
- Burmester® is a registered trademark of Burmester Audiosysteme GmbH.
- Microsoft® and Windows media® are registered trademarks of Microsoft Corporation.
- SIRIUS® is a registered trademark of Sirius XM Radio Inc.
- HD Radio™ is a registered trademark of iBiquity Digital Corporation.
- Gracenote® is a registered trademark of Gracenote, Inc.
- ZAGAT Survey® and related brands are registered trademarks of Zagat Survey, LLC.

In this Operator's Manual you will find the following symbols:

### **WARNING**

Warning notes make you aware of dangers which could pose a threat to your health or life, or to the health and life of others.

### **Environmental note**

Environmental notes provide you with information on environmentally aware actions or disposal.

 Notes on material damage alert you to dangers that could lead to damage to your vehicle.

 Practical tips or further information that could be helpful to you.

- ▶ This symbol indicates an instruction that must be followed.
- ▶ Several of these symbols in succession indicate an instruction with several steps.

 This symbol tells you where you can find more information about a topic.

 This symbol indicates a warning or an instruction that is continued on the next page.

 **Display** This text indicates a message on the multifunction display/multimedia display.

## Publication details

### Internet

Further information about Mercedes-Benz vehicles and about Daimler AG can be found on the following websites:

<http://www.mbusa.com> (USA only)

<http://www.mercedes-benz.ca> (Canada only)

### Editorial office

©Daimler AG: not to be reprinted, translated or otherwise reproduced, in whole or in part, without written permission from Daimler AG.

### Vehicle manufacturer

Daimler AG  
Mercedesstraße 137  
70327 Stuttgart  
Germany

## Welcome to the world of Mercedes-Benz

We urge you to read this Operator's Manual carefully and familiarize yourself with the vehicle before driving. For your own safety and a longer vehicle life, follow the instructions and warning notices in this manual. Ignoring them could result in damage to the vehicle or personal injury to you or others.

Vehicle damage caused by failure to follow instructions is not covered by the Mercedes-Benz Limited Warranty.

The equipment or product designation of your vehicle may vary depending on:

- Model
- Order
- Country specification
- Availability

Mercedes-Benz therefore reserves the right to introduce changes in the following areas:

- Design
- Equipment
- Technical features

The equipment in your vehicle may therefore differ from that shown in the descriptions and illustrations.

The following are integral components of the vehicle:

- Printed Operator's Manual
- Maintenance Booklet
- Equipment-dependent supplements

Keep these documents in the vehicle at all times. If you sell the vehicle, always pass all documents on to the new owner.

You can also use the Mercedes-Benz Guides App:



Apple® iOS



Android™

Please note that the Mercedes-Benz Guides App may not yet be available in your country.

Mercedes-Benz USA, LLC  
Mercedes-Benz Canada, Inc.  
A Daimler Company

---

**Index** ..... 3

---

**Introduction** ..... 24

---

**At a glance** ..... 32

---

**Safety** ..... 42

---

**Opening and closing** ..... 79

---

**Seats, steering wheel and mirrors** .. 104

---

**Lights and windshield wipers** ..... 130

---

**Climate control** ..... 140

---

**Driving and parking** ..... 161

---

**On-board computer and displays** .... 256

---

**Stowage and features** ..... 325

---

**Maintenance and care** ..... 352

---

**Breakdown assistance** ..... 367

---

**Wheels and tires** ..... 384

---

**Technical data** ..... 425

---

## 1, 2, 3 ...

<b>4ETS (Electronic Traction System)</b>	
see ETS/4ETS (Electronic Traction System)	
<b>4MATIC (permanent four-wheel drive)</b>	213
<b>12 V socket</b>	
see Sockets	
<b>115 V socket</b>	337
<b>360° camera</b>	
Cleaning	363
Function/notes	224

## A

<b>ABS (Anti-lock Braking System)</b>	
Display message	278
Function/notes	68
Warning lamp	316
<b>Accident</b>	
Automatic measures after an accident	61
<b>Activating/deactivating cooling with air dehumidification</b>	146
<b>Activating/deactivating Night View Assist Plus</b>	
With spotlight function	232
<b>Active Blind Spot Assist</b>	
Activating/deactivating (on-board computer)	271
Display message	301
Function/information	234
<b>Active Body Control (ABC)</b>	
Display message	300
Function/notes	210
<b>Active Lane Keeping Assist</b>	
Activating/deactivating (on-board computer)	271
Display message	301
Function/information	237
<b>Active multicontour seat</b>	117
<b>Active Parking Assist</b>	
Detecting parking spaces	217
Display message	302
Exiting a parking space	219
Function/notes	216
Important safety notes	216

Parking	218
<b>ADAPTIVE BRAKE</b>	75
<b>Adaptive Brake Assist</b>	
Function/notes	72
<b>Adaptive Damping System (ADS)</b>	212
<b>Adaptive Highbeam Assist Plus</b>	
Display message	293
Function/notes	133
Switching on/off	133
<b>Additional speedometer</b>	274
<b>Additives (engine oil)</b>	430
<b>Air bags</b>	
Belt bags	48
Cushion air bags	53
Deployment	57
Display message	289
Front air bag (driver, front passenger)	52
Important safety notes	50
Introduction	50
Knee bag	52
Occupant Classification System (OCS)	53
PASSENGER AIR BAG indicator lamps	46
Side impact air bag	52
Window curtain air bag	53
<b>Air vents</b>	
Glove box	159
Important safety notes	158
Rear	160
Setting	158
Setting the center air vents	159
Setting the side air vents	159
<b>Air-conditioning system</b>	
see Climate control	
<b>AIRMATIC</b>	
Display message	299
Function/notes	212
<b>Alarm</b>	
ATA (Anti-Theft Alarm system)	78
Switching off (ATA)	78
Switching the function on/off (ATA)	78
<b>Alarm system</b>	
see ATA (Anti-Theft Alarm system)	
<b>Anti-lock braking system</b>	
see ABS (Anti-lock Braking System)	

- Anti-Theft Alarm system**  
see ATA (Anti-Theft Alarm system)
- Armrest**  
Stowage compartment ..... 327
- Ashtray** ..... 334
- Assistance display (on-board computer)** ..... 268
- Assistance menu (on-board computer)** ..... 269
- ASSYST PLUS**  
Displaying a service message ..... 358  
Hiding a service message ..... 358  
Resetting the service interval display ..... 358  
Service message ..... 357  
Special service requirements ..... 358
- ATA (Anti-Theft Alarm system)**  
Activating/deactivating ..... 78  
Function ..... 78  
Switching off the alarm ..... 78
- ATTENTION ASSIST**  
Activating/deactivating ..... 271  
Display message ..... 299  
Function/notes ..... 228
- Authorized Mercedes-Benz Center**  
see Qualified specialist workshop
- Authorized workshop**  
see Qualified specialist workshop
- AUTO lights**  
Display message ..... 293  
see Lights
- Automatic car wash (care)** ..... 359
- Automatic engine start (ECO start/stop function)** ..... 167
- Automatic engine switch-off (ECO start/stop function)** ..... 166
- Automatic headlamp mode** ..... 130
- Automatic transmission**  
Accelerator pedal position ..... 173  
Automatic drive program ..... 174  
Changing gear ..... 173  
DIRECT SELECT lever ..... 170  
Display message ..... 308  
Driving tips ..... 173  
Emergency running mode ..... 177  
Engaging drive position ..... 171  
Engaging neutral ..... 171  
Engaging park position automatically ..... 170  
Engaging reverse gear ..... 171  
Engaging the park position ..... 170  
Kickdown ..... 173  
Manual drive program ..... 174  
Manual drive program (Mercedes-AMG vehicles) ..... 175  
Oil temperature (on-board computer, Mercedes-AMG vehicles) ..... 275  
Overview ..... 170  
Problem (malfunction) ..... 177  
Program selector button ..... 173  
Pulling away ..... 165  
Starting the engine ..... 164  
Steering wheel paddle shifters ..... 174  
Transmission position display ..... 172  
Transmission positions ..... 172
- Automatic transmission emergency mode** ..... 177
- B**
- BAS (Brake Assist System)** ..... 69
- BAS PLUS (Brake Assist System PLUS) with Cross-Traffic Assist**  
Function/notes ..... 69
- BAS PLUS with Cross-Traffic Assist (Brake Assist PLUS with Cross-Traffic Assist)**  
Important safety notes ..... 69
- Battery (high-voltage)**  
see High-voltage battery
- Battery (SmartKey)**  
Checking ..... 82  
Important safety notes ..... 82  
Replacing ..... 82
- Battery (vehicle)**  
Charging ..... 374  
Display message ..... 295  
Important safety notes ..... 372  
Jump starting ..... 376
- Belt**  
see Seat belts
- Belt bag** ..... 48
- Blind Spot Assist**  
see Active Blind Spot Assist

- Brake Assist**  
see BAS (Brake Assist System)
- Brake fluid**  
Display message ..... 283  
Notes ..... 430
- Brake force distribution**  
see EBD (electronic brake force distribution)
- Brake lamps**  
Display message ..... 291
- Brake pedal**  
Pedal resistance/pedal travel ..... 44
- Brakes**  
ABS ..... 68  
Adaptive Brake Assist ..... 72  
BAS ..... 69  
BAS PLUS with Cross-Traffic Assist ..... 69  
Brake fluid (notes) ..... 430  
Display message ..... 278  
EBD ..... 75  
High-performance brake system .... 196  
Hill start assist ..... 165  
HOLD function ..... 208  
Important safety notes ..... 194  
Maintenance ..... 195  
Parking brake ..... 190  
RBS warning lamp ..... 315  
Recuperative Brake System ..... 44  
Riding tips ..... 194  
Warning lamp ..... 315
- Breakdown**  
Where will I find...? ..... 367  
see Flat tire  
see Towing away
- Brightness control (instrument cluster lighting)** ..... 35
- Buttons on the steering wheel** ..... 257
- C**
- California**  
Important notice for retail customers and lessees ..... 25
- Calling up a malfunction**  
see Display messages
- Camera**  
see 360° camera  
see Rear view camera
- Car**  
see Vehicle
- Care**  
360° camera ..... 363  
Car wash ..... 359  
Carpets ..... 366  
Display ..... 364  
Exhaust pipe ..... 363  
Exterior lights ..... 362  
Gear or selector lever ..... 365  
General notes ..... 359  
Interior ..... 364  
Matte finish ..... 361  
Night View Assist Plus ..... 364  
Paint ..... 361  
Plastic trim ..... 364  
Power washer ..... 360  
Rear view camera ..... 363  
Roof lining ..... 366  
Seat belt ..... 366  
Seat cover ..... 365  
Sensors ..... 362  
Steering wheel ..... 365  
Trim pieces ..... 365  
Washing by hand ..... 360  
Wheels ..... 361  
Windows ..... 362  
Wiper blades ..... 362  
Wooden trim ..... 365
- CD player (on-board computer)** ..... 266
- Center console**  
Overview ..... 37  
Stowage space ..... 326
- Center console in the rear compartment**  
Stowage compartment ..... 327
- Central locking**  
Locking/unlocking (SmartKey) ..... 79
- Changing the media source** ..... 265
- Charging**  
see Charging the high-voltage battery (important safety notes)
- Charging cable**  
Connecting ..... 185  
Controls ..... 183  
Important safety notes ..... 183  
Indicator lamp ..... 184

- Removing ..... 185
- Storing ..... 183
- Warming up ..... 182
- Charging the high-voltage battery (important safety notes) ..... 180**
- Chauffeur mode**
  - Display message ..... 310
  - Fully reclined position ..... 114
  - General notes ..... 111
  - Installing the head restraint ..... 113
  - Moving front-passenger seat into the chauffeur position ..... 112
  - Moving the front-passenger seat into the normal position ..... 113
  - Removing the head restraint ..... 113
- Child**
  - Restraint system ..... 62
- Child seat**
  - Forward-facing restraint system ..... 66
  - LATCH-type (ISOFIX) child seat anchors ..... 63
  - On the front-passenger seat ..... 65
  - Rearward-facing restraint system .... 66
  - Top Tether ..... 64
- Child-proof locks**
  - Important safety notes ..... 66
  - Rear doors ..... 67
- Children**
  - Special seat belt retractor ..... 62
- Cigarette lighter ..... 335**
- Cleaning**
  - Mirror turn signal ..... 362
- Climate control**
  - Automatic climate control ..... 141
  - Controlling automatically ..... 147
  - Cooling with air dehumidification .. 146
  - Defrosting the windows ..... 151
  - Defrosting the windshield ..... 151
  - ECO start/stop function ..... 145
  - General notes ..... 140
  - Immediate pre-entry climate control ..... 158
  - Indicator lamp ..... 147
  - Ionization ..... 155
  - Notes on using the automatic climate control ..... 145
  - Overview of systems ..... 140
  - Perfume atomizer ..... 153
  - Pre-entry climate control at departure time ..... 157
  - Pre-entry climate control via key ... 155
  - Problem with the rear window defroster ..... 152
  - Problems with cooling with air dehumidification ..... 147
  - Rear control panel ..... 141
  - Refrigerant ..... 432
  - Refrigerant filling capacity ..... 432
  - Setting the air distribution ..... 149
  - Setting the air vents ..... 158
  - Setting the airflow ..... 150
  - Setting the climate mode ..... 148
  - Setting the temperature ..... 148
  - Switching air-recirculation mode on/off ..... 152
  - Switching on/off ..... 145
  - Switching residual heat on/off ..... 152
  - Switching the rear window defroster on/off ..... 151
  - Switching the synchronization function on and off ..... 150
- Climate control system**
  - Climate control ..... 145
- Cockpit**
  - Overview ..... 32
- COLLISION PREVENTION ASSIST PLUS**
  - Activating/deactivating ..... 270
  - Display message ..... 284
  - Operation/notes ..... 71
- COMAND display**
  - Cleaning ..... 364
- Combination switch ..... 131**
- Consumption statistics (on-board computer) ..... 262**
- Convenience closing feature ..... 96**
- Convenience opening feature ..... 95**
- Coolant (engine)**
  - Checking the level ..... 356
  - Display message ..... 294
  - Displaying the temperature (on-board computer) ..... 269
  - Filling capacity ..... 431
  - Important safety notes ..... 431
  - Temperature gauge ..... 257
  - Warning lamp ..... 320



- Coolbox** ..... 339
  - Cooling**
    - see Climate control
  - Copyright** ..... 31
  - Cornering light function**
    - Display message ..... 291
    - Function/notes ..... 132
  - Crash-responsive emergency lighting** ..... 135
  - Crosswind Assist (vehicles with MAGIC BODY CONTROL)** ..... 210
  - Crosswind Assist (vehicles without MAGIC BODY CONTROL)** ..... 75
  - Cruise control**
    - Calling up the speed last stored .... 198
    - Cruise control lever ..... 197
    - Deactivating ..... 199
    - Display message ..... 305
    - Driving system ..... 197
    - Function/notes ..... 197
    - General notes ..... 197
    - Important safety notes ..... 197
    - Setting a speed ..... 198
    - Storing and maintaining current speed ..... 198
  - Cup holder**
    - Center console ..... 331
    - Important safety notes ..... 330
    - Rear compartment ..... 331
    - Temperature controlled ..... 332
  - Cushion air bags** ..... 53
  - Customer Assistance Center (CAC)** ..... 29
  - Customer Relations Department** ..... 29
- D**
- Data**
    - see Technical data
  - Data carrier**
    - Selecting ..... 266
  - Daytime running lamps**
    - Display message ..... 293
    - Function/notes ..... 130
    - Switching on/off (on-board computer) ..... 274
  - Declarations of conformity** ..... 28
  - Diagnostics connection** ..... 28
  - Digital speedometer** ..... 263
  - DIRECT SELECT lever**
    - Automatic transmission ..... 170
  - Display**
    - see Display messages
    - see Warning and indicator lamps
  - Display message**
    - Hybrid drive system ..... 297
  - Display messages**
    - ASSYST PLUS ..... 357
    - Calling up (on-board computer) .... 277
    - Driving systems ..... 299
    - Engine ..... 294
    - General notes ..... 277
    - Hiding (on-board computer) ..... 277
    - Introduction ..... 277
    - Lights ..... 291
    - Safety systems ..... 278
    - SmartKey ..... 312
    - Tires ..... 306
    - Vehicle ..... 308
  - Distance recorder**
    - see Odometer
    - see Trip odometer
  - Distance warning (warning lamp) ....** 322
  - Distance warning function**
    - Function/notes ..... 71
  - DISTRONIC PLUS**
    - Activating ..... 201
    - Activation conditions ..... 201
    - Cruise control lever ..... 201
    - Deactivating ..... 205
    - Display message ..... 303
    - Displays in the instrument cluster .. 204
    - Driving tips ..... 205
    - Driving with DISTRONIC PLUS ..... 202
    - Function/notes ..... 199
    - Important safety notes ..... 200
    - Setting a speed ..... 203
    - Setting the specified minimum distance ..... 204
    - Stopping ..... 203
    - with Steering Assist and Stop&Go Pilot ..... 207
  - Doors**
    - Automatic locking (switch) ..... 87
    - Central locking/unlocking (SmartKey) ..... 79

- Control panel ..... 40
- Display message ..... 310
- Emergency locking ..... 88
- Emergency unlocking ..... 87
- Important safety notes ..... 85
- Opening (from inside) ..... 86
- Power closing ..... 87
- Drinking and driving** ..... 193
- Drive program**
  - Automatic ..... 174
  - Manual ..... 174
  - Manual (Mercedes-AMG vehicles) ..... 175
  - SETUP (on-board computer) ..... 276
- Driver's door**
  - see Doors
- Driving abroad**
  - Mercedes-Benz Service ..... 358
- Driving Assistance package** ..... 234
- Driving on flooded roads** ..... 196
- Driving safety systems**
  - ABS (Anti-lock Braking System) ..... 68
  - ADAPTIVE BRAKE ..... 75
  - Adaptive Brake Assist ..... 72
  - BAS (Brake Assist System) ..... 69
  - BAS PLUS with Cross-Traffic Assist ..... 69
  - COLLISION PREVENTION ASSIST PLUS ..... 71
  - Distance warning function ..... 71
  - EBD (electronic brake force distribution) ..... 75
  - ESP® (Electronic Stability Program) ..... 73
  - Important safety information ..... 68
  - Overview ..... 68
  - PRE-SAFE® Brake ..... 75
  - Recuperative Brake System ..... 44
  - STEER CONTROL ..... 77
- Driving systems**
  - 360° camera ..... 224
  - Active Blind Spot Assist ..... 234
  - Active Body Control ABC ..... 210
  - Active Lane Keeping Assist ..... 237
  - Active Parking Assist ..... 216
  - AIRMATIC ..... 212
  - ATTENTION ASSIST ..... 228
  - Cruise control ..... 197
  - Display message ..... 299
  - DISTRONIC PLUS ..... 199
  - DISTRONIC PLUS with Steering Assist and Stop&Go Pilot ..... 207
  - Driving Assistance package ..... 234
  - HOLD function ..... 208
  - Night View Assist Plus ..... 230
  - PARKTRONIC ..... 214
  - Rear view camera ..... 220
  - Traffic Sign Assist ..... 229
- Driving tips**
  - AMG ceramic brakes ..... 196
  - Automatic transmission ..... 173
  - Brakes ..... 194
  - Break-in period ..... 161
  - DISTRONIC PLUS ..... 205
  - Downhill gradient ..... 194
  - Drinking and driving ..... 193
  - Driving in winter ..... 196
  - Driving on flooded roads ..... 196
  - Driving on wet roads ..... 196
  - Exhaust check ..... 193
  - Fuel ..... 192
  - General ..... 192
  - Hydroplaning ..... 196
  - Icy road surfaces ..... 196
  - Limited braking efficiency on salted roads ..... 195
  - Snow chains ..... 386
  - Subjecting brakes to a load ..... 194
  - The first 1000 miles (1500 km) ..... 161
  - Wet road surface ..... 194
- DVD video**
  - Operating (on-board computer) ..... 267

## E

### **EASY-ENTRY feature**

- Function/notes ..... 122

### **EASY-EXIT feature**

- Crash-responsive ..... 123
- Function/notes ..... 122

### **EBD (electronic brake force distribution)**

- Display message ..... 280
- Function/notes ..... 75

- ECO display**
  - Function/notes ..... 193
  - On-board computer ..... 262
- ECO start/stop function**
  - Automatic engine start ..... 167
  - Automatic engine switch-off ..... 166
  - Deactivating/activating ..... 167
  - General information ..... 166
  - Important safety notes ..... 166
  - Introduction ..... 166
- Electronic Stability Program**
  - see ESP® (Electronic Stability Program)
- Emergency**
  - Automatic measures after an accident ..... 61
- Emergency release**
  - Driver's door ..... 87
  - Trunk ..... 94
  - Vehicle ..... 87
- Emergency Tensioning Devices**
  - Activation ..... 57
- Emissions control**
  - Service and warranty information .... 25
- Engine**
  - Check Engine warning lamp ..... 320
  - Display message ..... 294
  - ECO start/stop function ..... 166
  - Engine number ..... 427
  - Irregular running ..... 169
  - Jump-starting ..... 376
  - Starting (important safety notes) ... 164
  - Starting problems ..... 169
  - Starting the engine with the SmartKey ..... 164
  - Starting via smartphone ..... 164
  - Starting with the Start/Stop button ..... 164
  - Switching off ..... 190
  - Switching off with the Start/Stop button ..... 190
  - Switching off with the vehicle key .. 190
  - Tow-starting (vehicle) ..... 381
- Engine electronics**
  - Problem (malfunction) ..... 169
- Engine oil**
  - Adding ..... 355
  - Additives ..... 430
  - Checking the oil level ..... 353
  - Checking the oil level using the dipstick ..... 353
  - Checking the oil level using the on-board computer ..... 355
  - Display message ..... 296
  - Filling capacity ..... 430
  - General notes ..... 429
  - Notes about oil grades ..... 429
  - Notes on oil level/consumption .... 353
  - Temperature (on-board computer, Mercedes-AMG vehicles) ..... 275
  - Viscosity ..... 430
- ESP® (Electronic Stability Program)**
  - AMG menu (on-board computer) ... 276
  - Characteristics ..... 73
  - Deactivating/activating ..... 269
  - Deactivating/activating (notes) ..... 74
  - Display message ..... 278
  - Function/notes ..... 73
  - General notes ..... 73
  - Important safety information ..... 73
  - Trailer stabilization ..... 74
  - Warning lamp ..... 317
- ETS/4ETS (Electronic Traction System)** ..... 73
- Exhaust**
  - see Exhaust pipe
- Exhaust check** ..... 193
- Exhaust pipe**
  - Cleaning ..... 363
- Exhaustive discharging (high-voltage battery)** ..... 374
- Exterior lighting**
  - Cleaning ..... 362
  - see Lights
- Exterior mirrors**
  - Adjusting ..... 123
  - Dipping (automatic) ..... 124
  - Folding in/out (automatically) ..... 124
  - Folding in/out (electrically) ..... 124
  - Out of position (troubleshooting) ... 124
  - Setting ..... 124
  - Storing settings (memory function) ..... 126
  - Storing the parking position ..... 125
- Eyeglasses compartment** ..... 326

<b>F</b>	
<b>Features</b> .....	330
<b>Filling capacities (Technical data)</b> ...	427
<b>Flat tire</b>	
Changing a wheel/mounting the spare wheel .....	405
MOExtended tires .....	368
Preparing the vehicle .....	367
TIREFIT kit .....	369
<b>Floormats</b> .....	350
<b>Folding table</b> .....	328
<b>Frequencies</b>	
Mobile phone .....	425
Two-way radio .....	425
<b>Front-passenger seat</b>	
Adjusting from the driver's seat ....	108
Adjusting from the rear compartment .....	108
<b>Fuel</b>	
Additives .....	429
Consumption statistics .....	262
Displaying the current consumption .....	261
Displaying the range .....	261
Driving tips .....	192
Fuel gauge .....	33
Grade (gasoline) .....	428
Important safety notes .....	428
Problem (malfunction) .....	180
Refueling .....	177
Tank content/reserve fuel .....	428
<b>Fuel level</b>	
Calling up the range (on-board computer) .....	261
<b>Fuel tank</b>	
Capacity .....	428
Problem (malfunction) .....	180
<b>Fuses</b>	
Allocation chart .....	381, 383
Before changing .....	382
Dashboard fuse box .....	382
Fuse box in the engine compartment .....	383
Fuse box in the front-passenger footwell .....	382
Fuse box in the trunk .....	383
Important safety notes .....	381

<b>G</b>	
<b>Garage door opener</b>	
Clearing the memory .....	350
General notes .....	347
Important safety notes .....	348
Opening/closing the garage door ..	350
Problems when programming .....	349
Programming (button in the rear-view mirror) .....	348
Synchronizing the rolling code .....	349
<b>Gasoline</b> .....	428
<b>Gear indicator (on-board computer, Mercedes-AMG vehicles)</b> .....	275
<b>Genuine parts</b> .....	24
<b>Glove box</b> .....	326

<b>H</b>	
<b>Handbrake</b>	
see Parking brake	
<b>HANDS-FREE ACCESS</b> .....	91
<b>Hazard warning lamps</b> .....	132
<b>Head restraints</b>	
Adjusting .....	114
Adjusting (manually) .....	115
Adjusting (rear) .....	116
EASY ADJUST luxury head restraint .....	115
Luxury .....	115
Supplementary cushion .....	116
<b>Head-up display</b>	
Adjusting the brightness .....	273
Displays and operating .....	259
Function/notes .....	259
Important safety notes .....	259
Selecting displays .....	273
Setting the position .....	273
<b>Headlamps</b>	
Fogging up .....	134
see Automatic headlamp mode	
<b>Heating</b>	
see Climate control	
<b>High beam flasher</b> .....	132
<b>High-beam headlamps</b>	
Adaptive Highbeam Assist PLUS ....	133
Display message .....	292
Switching on/off .....	132

<b>High-voltage battery</b>	
Battery care .....	182
Charging (charging station) .....	186
Charging (mains socket) .....	183
Charging (wallbox) .....	185
Charging cable warming .....	182
Cruise range .....	182
Energy consumption .....	182
General notes .....	43
Method of operation .....	181
Outside temperatures .....	182
Overvoltage protection .....	182
Problems with the charging process .....	187
Terms of use .....	182
Vehicle fire .....	43
<b>Hill start assist</b> .....	165
<b>HOLD function</b>	
Activating .....	209
Activation conditions .....	209
Deactivating .....	209
Display message .....	303
Function/notes .....	208
General notes .....	208
<b>Hood</b>	
Closing .....	353
Display message .....	310
Important safety notes .....	352
Opening .....	352
<b>Horn</b> .....	32
<b>HUD</b>	
see Head-up display	
<b>Hybrid drive system</b>	
Automatic switch off .....	42
Danger of electric shock .....	42
Display message .....	297
General notes .....	42
High-voltage battery .....	43
Important safety notes .....	42
Manual switch off .....	42
Opening the hood .....	43
Warning lamp .....	315
<b>Hybrid vehicles</b>	
Important safety notes .....	42
<b>Hydroplaning</b> .....	196

## I

<b>Ignition lock</b>	
see Key positions	
<b>Immobilizer</b> .....	78
<b>Indicator and warning lamps</b>	
COLLISION PREVENTION ASSIST PLUS .....	322
<b>Indicator lamps</b>	
see Warning and indicator lamps	
<b>Indicators</b>	
see Turn signals	
<b>Instrument cluster</b>	
Overview .....	33
Warning and indicator lamps .....	34
<b>Instrument cluster lighting</b> .....	256
<b>Interior lighting</b>	
Control .....	135
Emergency lighting .....	135
Overview .....	134
Reading lamp .....	134

## J

<b>Jack</b>	
Using .....	406
<b>Jump starting (engine)</b> .....	376

## K

<b>Key positions</b>	
SmartKey .....	162
Start/Stop button .....	162
<b>KEYLESS-GO</b>	
Convenience closing feature .....	96
Deactivation .....	80
Locking .....	80
Start function .....	81
Unlocking .....	80
<b>Kickdown</b>	
Driving tips .....	173
<b>Knee bag</b> .....	52

## L

<b>Lamps</b>	
see Warning and indicator lamps	
<b>Lane Keeping Assist</b>	
see Active Lane Keeping Assist	

<b>LATCH-type (ISOFIX) child seat anchors</b> .....	63
<b>License plate lamp (display message)</b> .....	292
<b>Light function, active</b>	
Display message .....	293
<b>Light sensor (display message)</b> .....	293
<b>Lights</b>	
Adaptive Highbeam Assist PLUS ....	133
Automatic headlamp mode .....	130
Cornering light function .....	132
Fogged up headlamps .....	134
General notes .....	130
Hazard warning lamps .....	132
High beam flasher .....	132
High-beam headlamps .....	132
Light switch .....	130
Low-beam headlamps .....	131
Parking lamps .....	131
Setting exterior lighting .....	130
Standing lamps .....	131
Switching the daytime running lamps on/off (on-board computer) .....	274
Switching the spotlight on/off .....	274
Turn signals .....	131
see Interior lighting	
see Replacing bulbs	
<b>Loading guidelines</b> .....	325
<b>Locking</b>	
see Central locking	
<b>Locking (doors)</b>	
Automatic .....	87
Emergency locking .....	88
From inside (central locking button) .....	86
<b>Locking centrally</b>	
see Central locking	
<b>Low-beam headlamps</b>	
Display message .....	291
Switching on/off .....	131
<b>Lumbar support</b>	
Adjusting the 4-way lumbar support .....	118
<b>Luxury head restraints</b> .....	115

## M

<b>M+S tires</b> .....	386
<b>Magic Body Control</b> .....	210
<b>MAGIC SKY CONTROL</b> .....	100
<b>Malfunction message</b>	
see Display messages	
<b>Matte finish (cleaning instructions)</b> .....	361
<b>Maximum charge current</b>	
Setting (charging cable) .....	184
Setting (on-board computer) .....	272
<b>MBC</b>	
see Magic Body Control	
<b>mbrace</b>	
Call priority .....	344
Display message .....	283
Downloading destinations (COMAND) .....	344
Downloading routes .....	347
Emergency call .....	341
General notes .....	340
Geo fencing .....	347
Locating a stolen vehicle .....	346
MB info call button .....	343
Remote fault diagnosis .....	346
Remote vehicle locking .....	345
Roadside Assistance button .....	342
Search & Send .....	344
Self-test .....	341
Speed alert .....	347
System .....	341
Triggering the vehicle alarm .....	347
Vehicle remote unlocking .....	345
<b>Mechanical key</b>	
Function/notes .....	81
General notes .....	81
Inserting .....	82
Locking vehicle .....	88
Removing .....	81
Unlocking the driver's door .....	87
<b>Media Interface</b>	
USB port in the armrest of the center console .....	327
see Separate operating instructions	
<b>Memory card (audio)</b> .....	266
<b>Memory function</b>	
In the rear compartment .....	127

- Seats, steering wheel, exterior mirrors ..... 126
  - Storing settings (rear compartment) ..... 127
  - Mercedes-Benz Intelligent Drive**
    - 360° camera ..... 224
    - ABS (Anti-lock Brake System) ..... 68
    - Active Blind Spot Assist ..... 234
    - Active Lane Keeping Assist ..... 237
    - Active Parking Assist ..... 216
    - ATTENTION ASSIST ..... 228
    - BAS (Brake Assist) ..... 69
    - BAS PLUS (Brake Assist PLUS) with Cross-Traffic Assist ..... 69
    - Crosswind Assist (vehicles with MAGIC BODY CONTROL) ..... 210
    - Crosswind Assist (vehicles without MAGIC BODY CONTROL) ..... 75
    - DISTRONIC PLUS ..... 199
    - DISTRONIC PLUS with Steering Assist and Stop&Go Pilot ..... 207
    - ESP® (Electronic Stability Program) ..... 73
    - General notes ..... 197
    - MAGIC BODY CONTROL ..... 210
    - Night View Assist Plus ..... 230
    - PARKTRONIC ..... 214
    - PRE-SAFE® (anticipatory occupant protection) ..... 59
    - PRE-SAFE® Brake ..... 75
    - PRE-SAFE® PLUS (anticipatory occupant protection PLUS) ..... 60
    - Rear view camera ..... 220
    - ROAD SURFACE SCAN ..... 211
    - Traffic Sign Assist ..... 229
  - Message memory (on-board computer)** ..... 277
  - Messages**
    - see Display messages
    - see Warning and indicator lamps
  - Mirror turn signal**
    - Cleaning ..... 362
  - Mirrors**
    - see Exterior mirrors
    - see Rear-view mirror
    - see Vanity mirror (in the sun visor)
  - Mobile phone**
    - Frequencies ..... 425
    - Installation ..... 425
    - Menu (on-board computer) ..... 267
    - Transmission output (maximum) .... 425
  - Modifying the programming (SmartKey)** ..... 81
  - MOExtended tires** ..... 368
  - Mounting wheels**
    - Lowering the vehicle ..... 409
    - Mounting a new wheel ..... 409
    - Preparing the vehicle ..... 406
    - Raising the vehicle ..... 406
    - Removing a wheel ..... 408
    - Securing the vehicle against rolling away ..... 406
  - MP3**
    - Operation ..... 266
  - Multicontour seat** ..... 117
  - Multifunction display**
    - Function/notes ..... 258
  - Multifunction steering wheel**
    - Operating the on-board computer .. 257
    - Overview ..... 35
- N**
- Navigation**
    - Menu (on-board computer) ..... 263
  - Night View Assist Plus**
    - Activating/deactivating ..... 232
    - Cleaning ..... 364
    - Display message ..... 302
    - Function/notes ..... 230
    - Pedestrian and animal recognition ..... 231
    - Problem (malfunction) ..... 234
    - Switching automatic activation on/off ..... 270
  - Notes on breaking-in a new vehicle** ..... 161
- O**
- Occupant Classification System (OCS)**
    - Conditions ..... 53
    - Faults ..... 57

- Operation ..... 54
  - System self-test ..... 56
  - Occupant safety**
    - Air bags ..... 50
    - Automatic measures after an accident ..... 61
    - Children in the vehicle ..... 61
    - Important safety notes ..... 45
    - Introduction to the restraint system ..... 44
    - Occupant Classification System (OCS) ..... 53
    - PASSENGER AIR BAG indicator lamps ..... 46
    - Pets in the vehicle ..... 67
    - PRE-SAFE® (anticipatory occupant protection) ..... 59
    - PRE-SAFE® PLUS (anticipatory occupant protection PLUS) ..... 60
    - Restraint system warning lamp ..... 45
  - OCS**
    - Conditions ..... 53
    - Faults ..... 57
    - Operation ..... 54
    - System self-test ..... 56
  - Odometer** ..... 261
  - Oil**
    - see Engine oil
  - On-board computer**
    - AMG menu ..... 275
    - Assistance graphic menu ..... 268
    - Assistance menu ..... 269
    - Display messages ..... 277
    - Displaying a service message ..... 358
    - DISTRONIC PLUS ..... 204
    - Factory settings ..... 275
    - Head-up display ..... 259
    - HYBRID menu ..... 272
    - Important safety notes ..... 256
    - Instrument cluster menu ..... 274
    - Lights menu ..... 274
    - Media menu ..... 265
    - Menu overview ..... 261
    - Message memory ..... 277
    - Navigation menu ..... 263
    - Operation ..... 257
    - Radio menu ..... 265
    - Service menu ..... 269
    - Settings menu ..... 269
    - Standard display ..... 261
    - Telephone menu ..... 267
    - Trip menu ..... 261
    - Video DVD operation ..... 267
  - Online access to the vehicle**
    - Data protection ..... 188
    - Functions ..... 189
    - General information ..... 188
    - Internet ..... 189
  - Opening the fuel filler flap**  
(PLUG-IN HYBRID vehicles) ..... 179
  - Operating safety**
    - Declaration of conformity ..... 28
    - Important safety notes ..... 27
  - Operating system**
    - see On-board computer
  - Operator's Manual**
    - Overview ..... 25
    - Vehicle equipment ..... 25
  - Outside temperature display** ..... 257
  - Overhead control panel** ..... 39
  - Override feature**
    - Rear side windows ..... 67
- P**
- Paint code number** ..... 426
  - Paintwork (cleaning instructions) ...** 361
  - Panic alarm** ..... 44
  - Panorama roof with power tilt/sliding panel**
    - Important safety notes ..... 97
    - Opening/closing the roller sunblind ..... 100
    - Operating ..... 98
    - Operating the roller sunblinds for the sliding sunroof ..... 99
    - Problem (malfunction) ..... 103
    - Rain closing feature ..... 99
    - Resetting ..... 102
    - Reversing feature ..... 98
  - Parcel net hooks** ..... 329
  - Parking**
    - Important safety notes ..... 189
    - Parking brake ..... 190



- Position of exterior mirror, front-passenger side ..... 125
- Rear view camera ..... 220
- Switching off the engine ..... 190
- see PARKTRONIC
- Parking aid**
- see 360° camera
- see Active Parking Assist
- see Exterior mirrors
- see PARKTRONIC
- see Rear view camera
- Parking assistance**
- see PARKTRONIC
- Parking brake**
- Applying automatically ..... 191
- Applying or releasing manually ..... 191
- Display message ..... 281
- Electric parking brake ..... 190
- Emergency braking ..... 192
- General notes ..... 190
- Releasing automatically ..... 191
- Warning lamp ..... 319
- Parking lamps**
- Switching on/off ..... 131
- PARKTRONIC**
- Deactivating/activating ..... 215
- Driving system ..... 214
- Function/notes ..... 214
- Important safety notes ..... 214
- Problem (malfunction) ..... 216
- Range of the sensors ..... 214
- Warning display ..... 215
- PASSENGER AIR BAG**
- Display message ..... 289
- Indicator lamps ..... 46
- Problem (malfunction) ..... 289
- Perfume atomizer**
- Operating ..... 153
- Problem (malfunction) ..... 155
- Vial ..... 153
- Pets in the vehicle** ..... 67
- Plastic trim (cleaning instructions)** ..... 364
- PLUG-IN HYBRID operating**
- Electrical energy generated ..... 249
- PLUG-IN HYBRID operation**
- Automatic engine start (ECO start/stop function) ..... 253
- Automatic engine switch-off (ECO start/stop function) ..... 252
- Charge level of the high-voltage battery ..... 245
- Charging the high-voltage battery .. 246
- Displaying the total range and electric range ..... 248
- Driving tips ..... 251
- ECO start/stop function ..... 252
- Electric motor (power display) ..... 242
- Electrical energy generated (COMAND) ..... 249
- Energy flow display ..... 245
- Fuel consumption ..... 249
- Fuel consumption (COMAND) ..... 249
- General notes ..... 240
- Haptic accelerator pedal ..... 251
- High-voltage battery (condition of charge) ..... 245
- Hybrid drive system overview ..... 241
- HYBRID menu ..... 272
- Important safety notes ..... 240
- Instrument cluster (power display) ..... 242
- Instrument cluster overview ..... 242
- Manual drive program ..... 250
- Noiseless start ..... 249
- Operating (on-board computer) ..... 245
- Operating mode ..... 243
- Overrun mode ..... 253
- Parking ..... 253
- Power display ..... 244
- Power display (electric motor) ..... 242
- Problems ..... 254
- Problems with SRS (supplemental restraint system) ..... 255
- Problems with the combustion engine ..... 254
- Problems with the hybrid drive system ..... 255
- Problems with the Recuperative Brake System ..... 254
- Program selector button ..... 250
- Pulling away ..... 250
- READY display ..... 249
- Recuperative Brake System ..... 240
- Resetting the values (COMAND) ... 249
- Route-based operating strategy .... 253

Starting .....	249
When the vehicle is stationary .....	251
<b>Power locks</b> .....	87
<b>Power washers</b> .....	360
<b>Power windows</b>	
see Side windows	
<b>Pre-entry climate control (via SmartKey)</b>	
Problems (malfunctions) .....	157
<b>Pre-entry climate control at departure time</b>	
General notes .....	157
<b>Pre-entry climate control at time of departure</b>	
Setting departure time .....	158
<b>Pre-entry climate control via key</b>	
General notes .....	155
<b>PRE-SAFE® (anticipatory occupant protection)</b>	
Display message .....	284
Operation .....	59
<b>PRE-SAFE® Brake</b>	
Activating/deactivating .....	271
Display message .....	284
Function/notes .....	75
Important safety notes .....	76
Warning lamp .....	322
<b>PRE-SAFE® PLUS (anticipatory occupant protection PLUS)</b>	
Display message .....	284
Operation .....	60
<b>Program selector button</b> .....	173
<b>Protection against theft</b>	
ATA (Anti-Theft Alarm system) .....	78
Immobilizer .....	78
<b>Protection of the environment</b>	
General notes .....	24
<b>Pulling away</b>	
Automatic transmission .....	165
General notes .....	165
Hill start assist .....	165

## Q

<b>QR code</b>	
Mercedes-Benz Guide App .....	1
Rescue card .....	29
<b>Qualified specialist workshop</b> .....	28

## R

<b>Radio</b>	
Selecting a station .....	265
<b>Radio-wave reception/transmission in the vehicle</b>	
Declaration of conformity .....	28
<b>Rain closing feature</b>	
Panorama sliding sunroof .....	99
<b>RBS (Recuperative Brake System)</b>	
Warning lamp .....	315
<b>Reading lamp</b> .....	134
<b>Rear compartment</b>	
Activating/deactivating climate control .....	145
Setting the air distribution .....	149
Setting the air vents .....	160
Setting the airflow .....	150
Setting the temperature .....	148
Stowage compartment .....	327
<b>Rear lamps</b>	
see Lights	
<b>Rear seats</b>	
Adjusting .....	107
Adjusting a rear reclining seat .....	107
Overview .....	41
Setting the reclined position .....	107
<b>Rear view camera</b>	
Cleaning instructions .....	363
Displays in the COMAND display ...	221
Function/notes .....	220
<b>Rear window blind</b> .....	334
<b>Rear window defroster</b>	
Problem (malfunction) .....	152
Switching on/off .....	151
<b>Rear-view mirror</b>	
Anti-glare (manual) .....	123
Dipping (automatic) .....	124
<b>Recuperative Brake System</b>	
Driving safety systems .....	44
Important safety notes .....	44
<b>Refrigerant (air-conditioning system)</b>	
Important safety notes .....	432
<b>Refueling</b>	
Fuel gauge .....	33
Important safety notes .....	177

Refueling process (PLUG-IN HYBRID vehicles) .....	178
see Fuel	
<b>Remote control</b>	
Garage door opener .....	347
Programming (garage door opener) .....	348
<b>Replacing bulbs</b>	
General notes .....	135
<b>Reporting safety defects</b> .....	29
<b>Rescue card</b> .....	29
<b>Reserve (fuel tank)</b>	
see Fuel	
<b>Reserve fuel</b>	
Display message .....	296
Warning lamp .....	320
<b>Residual heat (climate control)</b> .....	152
<b>Restraint system</b>	
Display message .....	287
Introduction .....	44
Warning lamp .....	319
Warning lamp (function) .....	45
<b>Reversing feature</b>	
Panorama sliding sunroof .....	98
Roller sunblinds .....	99
Side windows .....	94
Trunk lid .....	89
<b>Reversing lamps (display message)</b> .....	292
<b>ROAD SURFACE SCAN</b> .....	211
<b>Roadside Assistance (breakdown)</b> ....	26
<b>Roller sunblind</b>	
Panorama roof with power tilt/sliding panel .....	99
Rear side windows .....	333
Rear window .....	334
<b>Roller sunblind of the panorama roof with power tilt/sliding panel</b>	
Operating (front roller sunblind) ....	100
Operating (rear roller sunblind) ....	100
<b>Roof carrier</b> .....	330
<b>Roof lining and carpets (cleaning guidelines)</b> .....	366
<b>Roof load (maximum)</b> .....	433

## S

**Safety**

Children in the vehicle .....	61
Hybrid drive system .....	42
see Occupant safety	
see Operating safety	

**Safety notes**

Hybrid vehicles .....	42
-----------------------	----

**Safety system**

see Driving safety systems	
----------------------------	--

**SD memory card**

Selecting .....	266
-----------------	-----

**Seat**

Adjusting the front-passenger seat from the driver's seat .....	108
Multicontour seat in the rear compartment .....	117

**Seat belt buckle extender**

Display message .....	285
-----------------------	-----

**Seat belt extender**

Function/notes .....	49
----------------------	----

**Seat belts**

Adjusting the driver's and front-passenger seat belt .....	50
Adjusting the height .....	49
Cleaning .....	366
Correct usage .....	48
Fastening .....	49
Important safety guidelines .....	47
Introduction .....	46
Releasing .....	50
Seat belt extender .....	49
Warning lamp .....	313
Warning lamp (function) .....	50

**Seating**

Seating comfort package .....	117
-------------------------------	-----

**Seating comfort package**

.....	117
-------	-----

**Seats**

Active multicontour seat .....	117
Adjusting (electrically) .....	106
Adjusting (rear compartment) .....	107
Adjusting the 4-way lumbar support .....	118
Adjusting the head restraint .....	114
Calling up a stored setting (memory function) .....	127
Chauffeur mode .....	111

- Cleaning the cover ..... 365
- Correct driver's seat position ..... 104
- Display message ..... 310
- EASY-ENTRY/EXIT system ..... 122
- Important safety notes ..... 105
- Multicontour seat ..... 117
- Seat heating ..... 118
- Seat heating problem ..... 119
- Seat ventilation ..... 119
- Seat ventilation problem ..... 120
- Storing settings (memory function) ..... 126
- Switching seat heating on/off ..... 118
- Switching seat ventilation on/off .. 119
- Section**
- Wheels and tires ..... 384
- Securing a load**
- see Securing cargo
- Securing cargo** ..... 329
- Selector lever**
- Cleaning ..... 365
- see Automatic transmission
- Sensors (cleaning instructions)** ..... 362
- Service menu (on-board computer)** ..... 269
- Service message**
- see ASSYST PLUS
- Service products**
- Brake fluid ..... 430
- Coolant (engine) ..... 431
- Engine oil ..... 429
- Fuel ..... 428
- Important safety notes ..... 427
- Refrigerant (air-conditioning system) ..... 432
- Washer fluid ..... 431
- Setting the charge current (on-board computer)** ..... 272
- Setting the departure time (on-board computer)** ..... 272
- Settings**
- Factory (on-board computer) ..... 275
- On-board computer ..... 269
- SETUP (on-board computer)** ..... 276
- Side impact air bag** ..... 52
- Side marker lamp (display message)** ..... 292
- Side windows**
- Cleaning ..... 362
- Convenience closing feature ..... 96
- Convenience opening feature ..... 95
- Important safety information ..... 94
- Opening/closing ..... 95
- Problem (malfunction) ..... 97
- Resetting ..... 96
- Reversing feature ..... 94
- Sliding sunroof**
- see Panorama roof with power tilt/sliding panel
- SmartKey**
- Changing the battery ..... 82
- Changing the programming ..... 81
- Checking the battery ..... 82
- Convenience closing feature ..... 96
- Convenience opening feature ..... 95
- Display message ..... 312
- Door central locking/unlocking ..... 79
- Important safety notes ..... 79
- KEYLESS-GO start function ..... 81
- Loss ..... 84
- Mechanical key ..... 81
- Overview ..... 79
- Positions (ignition lock) ..... 162
- Problem (malfunction) ..... 84
- Starting the engine ..... 164
- Smartphone**
- Starting the engine ..... 164
- Snow chains** ..... 386
- Sockets**
- Center console ..... 336
- General notes ..... 336
- Rear compartment ..... 337
- Trunk ..... 337
- Special seat belt retractor** ..... 62
- Specialist workshop** ..... 28
- Speed, controlling**
- see Cruise control
- Speedometer**
- Activating/deactivating the additional speedometer ..... 274
- Digital ..... 263
- In the Instrument cluster ..... 33
- Selecting the display unit ..... 274
- Standing lamps**
- Display message ..... 292

- Switching on/off ..... 131
  - Start/Stop button**
  - General notes ..... 162
  - Key positions ..... 163
  - Removing ..... 163
  - Starting the engine ..... 164
  - Start/stop function**
  - see ECO start/stop function
  - Starting (engine)** ..... 164
  - STEER CONTROL** ..... 77
  - Steering**
  - Display message ..... 311
  - Warning lamps ..... 324
  - Steering Assist**
  - see DISTRONIC PLUS
  - Steering Assist and Stop&Go Pilot (DISTRONIC PLUS)**
  - Display message ..... 305
  - Steering assistant STEER CONTROL**
  - see STEER CONTROL
  - Steering wheel**
  - Adjusting (electrically) ..... 120
  - Button overview ..... 35
  - Buttons (on-board computer) ..... 257
  - Cleaning ..... 365
  - EASY ENTRY/EXIT feature ..... 122
  - Important safety notes ..... 120
  - Paddle shifters ..... 174
  - Steering wheel heating ..... 120
  - Storing settings (memory function) ..... 126
  - Steering wheel heating**
  - Problem (malfunction) ..... 122
  - Switching on/off ..... 120
  - Steering wheel paddle shifters** ..... 174
  - Stop&Go Pilot**
  - see DISTRONIC PLUS
  - Stowage areas** ..... 325
  - Stowage compartments**
  - Armrest (under) ..... 327
  - Center console ..... 326
  - Center console in rear compartment ..... 327
  - Cup holders ..... 330
  - Door ..... 327
  - Eyeglasses compartment ..... 326
  - Glove box ..... 326
  - Important safety information ..... 325
  - Rear ..... 327
  - Rear seat backrest ..... 328
  - Stowage net ..... 329
  - see Stowage areas
  - Stowage net** ..... 329
  - Stowage space**
  - Folding table ..... 328
  - Parcel net retainers ..... 329
  - Securing a load ..... 329
  - Stowage well beneath the trunk floor** ..... 329
  - Summer tires**
  - In winter ..... 386
  - Sun visor** ..... 333
  - Suspension mode**
  - Active Body Control ABC ..... 210
  - Suspension setting**
  - AIRMATIC ..... 212
  - Suspension settings**
  - SETUP (on-board computer) ..... 276
  - Switching air-recirculation mode on/off** ..... 152
- T**
- Tachometer** ..... 256
  - Tail lamps**
  - Display message ..... 292
  - see Lights
  - Tank content**
  - Fuel gauge ..... 33
  - Technical data**
  - Capacities ..... 427
  - Information ..... 425
  - Tires/wheels ..... 410
  - Vehicle data ..... 433
  - Telephone**
  - Accepting a call (multifunction steering wheel) ..... 267
  - Display message ..... 311
  - Introduction ..... 267
  - Menu (on-board computer) ..... 267
  - Number from the phone book ..... 268
  - Redialing ..... 268
  - Rejecting/ending a call ..... 268
  - Temperature**
  - Coolant ..... 257

- Coolant (on-board computer) ..... 269
- Engine oil (on-board computer, Mercedes-AMG vehicles) ..... 275
- Outside temperature ..... 257
- Setting (climate control) ..... 148
- Transmission oil (on-board computer, Mercedes-AMG vehicles) ..... 275
- Tire pressure**
  - Calling up (on-board computer) ..... 390
  - Checking manually ..... 390
  - Display message ..... 306
  - Maximum ..... 390
  - Not reached (TIREFIT) ..... 370
  - Notes ..... 389
  - Reached (TIREFIT) ..... 371
  - Recommended ..... 387
- Tire pressure loss warning system**
  - General notes ..... 393
  - Important safety notes ..... 393
  - Restarting ..... 394
- Tire pressure monitor**
  - Checking the tire pressure electronically ..... 392
  - Function/notes ..... 390
  - General notes ..... 390
  - Important safety notes ..... 391
  - Radio type approval for the tire pressure monitor ..... 393
  - Restarting ..... 392
  - Warning lamp ..... 323
  - Warning message ..... 392
- TIREFIT kit**
  - Important safety notes ..... 369
  - Storage location ..... 367
  - Tire pressure not reached ..... 370
  - Tire pressure reached ..... 371
  - Using ..... 369
- Tires**
  - Aspect ratio (definition) ..... 404
  - Average weight of the vehicle occupants (definition) ..... 403
  - Bar (definition) ..... 403
  - Changing a wheel ..... 405
  - Characteristics ..... 403
  - Checking ..... 385
  - Curb weight (definition) ..... 404
  - Definition of terms ..... 403
  - Direction of rotation ..... 405
  - Display message ..... 306
  - Distribution of the vehicle occupants (definition) ..... 405
  - DOT (Department of Transportation) (definition) ..... 403
  - DOT, Tire Identification Number (TIN) ..... 402
  - GAWR (Gross Axle Weight Rating) (definition) ..... 403
  - General notes ..... 410
  - GVW (Gross Vehicle Weight) (definition) ..... 403
  - GVWR (Gross Vehicle Weight Rating) (definition) ..... 404
  - Important safety notes ..... 384
  - Increased vehicle weight due to optional equipment (definition) ..... 403
  - Information on driving ..... 384
  - Kilopascal (kPa) (definition) ..... 404
  - Labeling (overview) ..... 400
  - Load bearing index (definition) ..... 405
  - Load index ..... 402
  - Load index (definition) ..... 404
  - Maximum load on a tire (definition) ..... 404
  - Maximum loaded vehicle weight (definition) ..... 404
  - Maximum permissible tire pressure (definition) ..... 404
  - Maximum tire load ..... 402
  - Maximum tire load (definition) ..... 404
  - MOExtended tires ..... 386
  - Optional equipment weight (definition) ..... 404
  - PSI (pounds per square inch) (definition) ..... 404
  - Replacing ..... 405
  - Service life ..... 385
  - Sidewall (definition) ..... 404
  - Snow chains ..... 386
  - Speed rating (definition) ..... 403
  - Storing ..... 405
  - Structure and characteristics (definition) ..... 403
  - Summer tires in winter ..... 386
  - Temperature ..... 399
  - TIN (Tire Identification Number) (definition) ..... 404

- Tire bead (definition) ..... 404
  - Tire pressure (definition) ..... 404
  - Tire pressures (recommended) ..... 403
  - Tire size (data) ..... 410
  - Tire size designation, load-bearing capacity, speed rating ..... 400
  - Tire tread ..... 385
  - Tire tread (definition) ..... 404
  - Total load limit (definition) ..... 405
  - Traction ..... 399
  - Traction (definition) ..... 405
  - Tread wear ..... 399
  - Uniform Tire Quality Grading Standards ..... 398
  - Uniform Tire Quality Grading Standards (definition) ..... 403
  - Wear indicator (definition) ..... 405
  - Wheel and tire combination ..... 412
  - Wheel rim (definition) ..... 403
  - see Flat tire
  - Top Tether** ..... 64
  - Tow-starting**
    - Emergency engine starting ..... 381
    - Important safety notes ..... 379
  - Towing a trailer**
    - ESP® (Electronic Stability Program) ..... 74
  - Towing away**
    - Important safety guidelines ..... 379
    - Installing the towing eye ..... 380
    - Notes for 4MATIC vehicles ..... 381
    - Removing the towing eye ..... 380
    - Transporting the vehicle ..... 381
    - With both axles on the ground ..... 380
  - Towing eye** ..... 367
  - Traffic Sign Assist**
    - Activating ..... 229
    - Display message ..... 303
    - Function/notes ..... 229
    - Important safety notes ..... 229
    - Instrument cluster display ..... 230
    - Switching on/off ..... 270
  - Transfer case** ..... 177
  - Transmission**
    - see Automatic transmission
  - Transporting the vehicle** ..... 381
  - Trim pieces (cleaning instructions)** ..... 365
  - Trip computer (on-board computer)** ..... 262
  - Trip odometer**
    - Calling up ..... 261
    - Resetting (on-board computer) ..... 263
  - Trunk**
    - Emergency release ..... 93
    - Important safety notes ..... 88
    - Locking separately ..... 93
    - Opening/closing (automatically from inside) ..... 92
    - Opening/closing (automatically from outside) ..... 90
    - Opening/closing (from outside, HANDS-FREE ACCESS) ..... 91
    - Opening/closing (manually from outside) ..... 89
    - Power closing ..... 87
  - Trunk lid**
    - Display message ..... 309
    - Obstacle recognition ..... 89
    - Opening dimensions ..... 433
    - Opening/closing ..... 88
  - Trunk load (maximum)** ..... 433
  - Turn signals**
    - Display message ..... 291
    - Switching on/off ..... 131
  - Two-way radio**
    - Frequencies ..... 425
    - Installation ..... 425
    - Transmission output (maximum) .... 425
    - Windshield (infrared reflective) ..... 351
  - Type identification plate**
    - see Vehicle identification plate
- U
- Unlocking**
    - Emergency unlocking ..... 87
    - From inside the vehicle (central unlocking button) ..... 86
  - Upshift indicator (on-board computer, Mercedes-AMG vehicles)** ..... 275

## V

**Vanity mirror (in the sun visor)** ..... 333

**Vehicle**

Correct use ..... 29  
 Data acquisition ..... 29  
 Display message ..... 308  
 Equipment ..... 25  
 Individual settings ..... 269  
 Limited Warranty ..... 29  
 Loading ..... 394  
 Locking (in an emergency) ..... 88  
 Locking (SmartKey) ..... 79  
 Lowering ..... 409  
 Maintenance ..... 26  
 Operating safety ..... 27  
 Parking ..... 189  
 Parking for a long period ..... 192  
 Pulling away ..... 165  
 Raising ..... 406  
 Reporting problems ..... 29  
 Securing from rolling away ..... 406  
 Towing away ..... 379  
 Transporting ..... 381  
 Unlocking (in an emergency) ..... 87  
 Unlocking (SmartKey) ..... 79  
 Vehicle data ..... 433

**Vehicle dimensions** ..... 433

**Vehicle emergency locking** ..... 88

**Vehicle identification number**

see VIN

**Vehicle identification plate** ..... 426

**Vehicle level**

Active Body Control ABC ..... 210  
 AIRMATIC ..... 212  
 Display message ..... 300

**Vehicle tool kit** ..... 367

**Video**

Operating the DVD ..... 267

**VIN**

Type plate ..... 426

## W

**Warning**

Stickers ..... 42

**Warning and indicator lamps**

ABS ..... 316

Brakes ..... 315

Check Engine ..... 320

Coolant ..... 320

Distance warning ..... 322

ESP® ..... 317

ESP® OFF ..... 319

Fuel tank ..... 320

General notes ..... 313

Hybrid drive system ..... 315

Overview ..... 34

Parking brake ..... 319

PASSENGER AIR BAG ..... 46

RBS (Recuperative Brake System) ..... 315

Reserve fuel ..... 320

Restraint system ..... 319

Seat belt ..... 313

Steering ..... 324

Tire pressure monitor ..... 323

**Warranty** ..... 25

**Washer fluid**

Display message ..... 311

**Wheel and tire combinations**

Tires ..... 412

**Wheel bolt tightening torque** ..... 409

**Wheel chock** ..... 406

**Wheels**

Changing a wheel ..... 405

Checking ..... 385

Cleaning ..... 361

General notes ..... 410

Important safety notes ..... 384

Information on driving ..... 384

Interchanging/changing ..... 405

Mounting a new wheel ..... 409

Mounting a wheel ..... 406

Removing a wheel ..... 408

Snow chains ..... 386

Storing ..... 405

Tightening torque ..... 409

Wheel size/tire size ..... 410

**Window curtain air bag**

Display message ..... 288

Operation ..... 53

**Windows**

see Side windows



<b>Windshield</b>	
Defrosting .....	151
Infrared reflective .....	351
<b>Windshield washer fluid</b>	
see Windshield washer system	
<b>Windshield washer system</b>	
Adding washer fluid .....	357
Important safety notes .....	431
Notes .....	431
<b>Windshield wipers</b>	
Problem (malfunction) .....	139
Replacing the wiper blades .....	136
Switching on/off .....	135
<b>Winter driving</b>	
Important safety notes .....	386
Slippery road surfaces .....	196
Snow chains .....	386
<b>Winter operation</b>	
Summer tires .....	386
<b>Winter tires</b>	
M+S tires .....	386
<b>Wiper blades</b>	
Cleaning .....	362
Important safety notes .....	136
Replacing .....	136
<b>Wooden trim (cleaning instructions)</b>	365
<b>Workshop</b>	
see Qualified specialist workshop	

## Protection of the environment

### General notes

#### Environmental note

Daimler's declared policy is one of comprehensive environmental protection.

The objectives are for the natural resources that form the basis of our existence on this planet to be used sparingly and in a manner that takes the requirements of both nature and humanity into account.

You too can help to protect the environment by operating your vehicle in an environmentally responsible manner.

Fuel consumption and the rate of engine, transmission, brake and tire wear are affected by these factors:

- operating conditions of your vehicle
- your personal driving style

You can influence both factors. You should bear the following in mind:

Operating conditions:

- avoid short trips as these increase fuel consumption.
- always make sure that the tire pressures are correct.
- do not carry any unnecessary weight.
- remove roof racks once you no longer need them.
- a regularly serviced vehicle will contribute to environmental protection. You should therefore adhere to the service intervals.
- always have service work carried out at a qualified specialist workshop.

Personal driving style:

- do not depress the accelerator pedal when starting the engine.
- do not warm up the engine when the vehicle is stationary.
- drive carefully and maintain a safe distance from the vehicle in front.
- avoid frequent, sudden acceleration and braking.

- change gear in good time and use each gear only up to  $\frac{2}{3}$  of its maximum engine speed.
- switch off the engine in stationary traffic.
- keep an eye on the vehicle's fuel consumption.

#### Environmental note

Have a defective high-voltage battery disposed of in an environmentally-responsible manner. Contact a qualified specialist workshop which has the necessary specialist knowledge and tools to carry out the work required. Mercedes-Benz recommends that you use an authorized Mercedes-Benz Center for this purpose.

### Environmental concerns and recommendations

Wherever the operating instructions require you to dispose of materials, first try to regenerate or re-use them. Observe the relevant environmental rules and regulations when disposing of materials. In this way you will help to protect the environment.

### Genuine Mercedes-Benz parts

#### Environmental note

Daimler AG also supplies reconditioned major assemblies and parts which are of the same quality as new parts. They are covered by the same Limited Warranty entitlements as new parts.

 Air bags and Emergency Tensioning Devices, as well as control units and sensors for these restraint systems, may be installed in the following areas of your vehicle:

- doors
- door pillars
- door sills
- seats
- cockpit
- instrument cluster
- center console

Do not install accessories such as audio systems in these areas. Do not carry out repairs or welding. You could impair the operating efficiency of the restraint systems.

Have aftermarket accessories installed at a qualified specialist workshop.

You could jeopardize the operating safety of your vehicle if you use parts, tires and wheels as well as accessories relevant to safety which have not been approved by Mercedes-Benz. This could lead to malfunctions in safety-relevant systems, e.g. the brake system. Use only genuine Mercedes-Benz parts or parts of equal quality. Only use tires, wheels and accessories that have been specifically approved for your vehicle.

Genuine Mercedes-Benz parts are subject to strict quality control. Every part has been specifically developed, manufactured or selected for and adapted to Mercedes-Benz vehicles. Only genuine Mercedes-Benz parts should therefore be used.

More than 300,000 different genuine Mercedes-Benz parts are available for Mercedes-Benz models.

All authorized Mercedes-Benz Centers maintain a supply of genuine Mercedes-Benz parts for necessary service and repair work. In addition, strategically located parts delivery centers provide quick and reliable parts service.

Always specify the vehicle identification number (VIN) when ordering genuine Mercedes-Benz parts (> page 426).

## Operator's Manual

### Vehicle equipment

**i** This Operator's Manual describes all models and all standard and optional equipment of your vehicle available at the time of going to print. Country-specific differences are possible. Bear in mind that your vehicle may not feature all functions described here. This also applies to safety-relevant systems and functions. The equipment in your vehicle may therefore differ from that shown in the descriptions and illustrations.

The original purchase agreement lists all systems installed in your vehicle.

Should you have any questions concerning equipment and operation, please consult an authorized Mercedes-Benz Center.

The Operator's Manual and Maintenance Booklet are important documents and should be kept in the vehicle.

## Service and vehicle operation

### Warranty

The implied warranty for your vehicle applies in accordance with the warranty terms and conditions in the Service and Warranty Information booklet.

Your authorized Mercedes-Benz Center will replace and repair all factory-installed parts in accordance with the following warranty terms and conditions:

- New Vehicle Limited Warranty
- Emission System Warranty
- Emission Performance Warranty
- California, Connecticut, Maine, Massachusetts, New York, Pennsylvania, Rhode Island and Vermont Emission Control System Warranty
- State warranty enforcement laws (lemon laws)

Replacement parts and accessories are covered by the Mercedes-Benz Parts and Accessories warranties. These are available at any authorized Mercedes-Benz Center.

**i** Should you lose your Service and Warranty Information booklet, have an authorized Mercedes-Benz Center arrange for a replacement. The new Service and Warranty Information booklet will be posted to you.

### Information for customers in California

Under California law you may be entitled to a replacement of your vehicle or a refund of the purchase price or lease price, if after a reasonable number of repair attempts Mercedes-Benz USA, LLC and/or its authorized repair or service facilities fail to fix one or more substantial defects or malfunctions in the vehicle that are covered by its express warranty.

During the period of 18 months from original delivery of the vehicle or the accumulation of 18,000 miles (approximately 29,000 km) on the odometer of the vehicle, whichever occurs first, a reasonable number of repair attempts is presumed for a retail buyer or lessee if one or more of the following occurs:

- (1) the same substantial defect or malfunction results in a condition that is likely to cause death or serious bodily injury if the vehicle is driven, that defect or malfunction has been subject to repair two or more times, and you have directly notified Mercedes-Benz USA, LLC in writing of the need for its repair.
- (2) the same substantial defect or malfunction of a less serious nature than category (1) has been subject to repair four or more times and you have directly notified Mercedes-Benz in writing of the need for its repair.
- (3) the vehicle is out of service by reason of repair of the same or different substantial defects or malfunctions for a cumulative total of more than 30 calendar days.

Please send your written notice to:

Mercedes-Benz USA, LLC  
Customer Assistance Center  
One Mercedes Drive  
Montvale, NJ 07645-0350

### Maintenance

The Service and Warranty Booklet describes all the necessary maintenance work which should be done at regular intervals.

Always have the Service and Warranty Booklet with you when you bring the vehicle to an authorized Mercedes-Benz Center. The service advisor will record every service for you in the Service and Warranty Booklet.

### Roadside Assistance

The Mercedes-Benz Roadside Assistance Program offers technical help in the event of a breakdown. Calls to the toll-free Roadside Assistance Hotline are answered by our agents 24 hours a day, 365 days a year.

**1-800-FOR-MERCEdes(1-800-367-6372)**  
**(USA)**  
**1-800-387-0100 (Canada)**

For additional information, refer to the Mercedes-Benz Roadside Assistance Program brochure (USA) or the "Roadside Assistance" section in the Service and Warranty booklet (Canada). You will find both in your vehicle literature portfolio.

### Change of address or change of ownership

In the event of a change of address, please send us the "Notification of Address Change" in the Service and Guarantee booklet or simply call the Mercedes-Benz Customer Assistance Center (USA) at the hotline number 1-800-FOR-MERCEdes(1-800-367-6372) or Customer Service Center (Canada) at 1-800-387-0100. This will assist us in contacting you in a timely manner should the need arise.

If you sell your Mercedes, please leave the entire literature in the vehicle so that it is available to the next owner.

If you have purchased a used car, please send us the "Notification of Used Car Purchase" in the Service and Guarantee booklet or simply call the Mercedes-Benz Customer Assistance Center (USA) at the hotline number 1-800-FOR-MERCEdes(1-800-367-6372) or Customer Service (Canada) at 1-800-387-0100.

### Vehicle operation outside the USA and Canada

If you plan to operate your vehicle in foreign countries, please be aware that:

- service facilities or replacement parts may not be readily available.
- unleaded fuel for vehicles with a catalytic converter may not be available. Leaded fuel may cause damage to the catalytic converter.
- the fuel may have a considerably lower octane rating. Unsuitable fuel can cause engine damage.

Some Mercedes-Benz models are available for delivery in Europe through our European Delivery Program. For details, consult an authorized Mercedes-Benz Center or write to one of the following addresses.

#### In the USA

Mercedes-Benz USA, LLC  
European Delivery Department

One Mercedes Drive  
Montvale, NJ 07645-0350

### In Canada

Mercedes-Benz Canada, Inc.  
European Delivery Department  
98 Vanderhoof Avenue  
Toronto, Ontario M4G 4C9

## Operating safety

### Important safety notes

#### WARNING

If you do not have the prescribed service/maintenance work or any required repairs carried out, this can result in malfunctions or system failures. There is a risk of an accident. Always have the prescribed service/maintenance work as well as any required repairs carried out at a qualified specialist workshop.

#### WARNING

Flammable material such as leaves, grass or twigs may ignite if they come into contact with hot parts of the exhaust system. There is a risk of fire.

When driving off road or on unpaved roads, check the vehicle's underside regularly. In particular, remove parts of plants or other flammable materials which have become trapped. In the case of damage, contact a qualified specialist workshop.

#### WARNING

Modifications to electronic components, their software as well as wiring can impair their function and/or the function of other networked components. In particular, systems relevant to safety could also be affected. As a result, these may no longer function as intended and/or jeopardize the operating safety of the vehicle. There is an increased risk of an accident and injury.

Never tamper with the wiring as well as electronic components or their software. You should have all work to electrical and elec-

tronic equipment carried out at a qualified specialist workshop.

#### There is a risk of damage to the vehicle if:

- the vehicle becomes stuck, e.g. on a high curb or an unpaved road
- you drive too fast over an obstacle, e.g. a curb or a hole in the road
- a heavy object strikes the undercarriage or parts of the chassis

In situations like this, the body, the undercarriage, chassis parts, wheels or tires could be damaged without the damage being visible. Components damaged in this way can unexpectedly fail or, in the case of an accident, no longer withstand the strain they are designed to.

If the underbody paneling is damaged, combustible materials such as leaves, grass or twigs can gather between the underbody and the underbody paneling. If these materials come in contact with hot parts of the exhaust system, they can catch fire.

In such situations, have the vehicle checked and repaired immediately at a qualified specialist workshop. If on continuing your journey you notice that driving safety is impaired, pull over and stop the vehicle immediately, paying attention to road and traffic conditions. In such cases, consult a qualified specialist workshop.

Hybrid vehicles have a combustion engine and an electric motor. The voltage supply for operating the vehicle electrically is provided by the vehicle's high-voltage electrical system.

#### DANGER

The vehicle's high-voltage electrical system is under high voltage. If you modify components in the vehicle's high-voltage electrical system or touch damaged components, you may be electrocuted. The components in the vehicle's high-voltage electrical system may be damaged in an accident, although the damage is not visible. There is a risk of fatal injury.

Following an accident, do not touch any high-voltage components and never modify the vehicle's high-voltage electrical system. Have the vehicle towed away after an accident and

the vehicle's high-voltage electrical system checked by a qualified specialist workshop.

The components of the vehicle's high-voltage electrical system are marked with yellow warning stickers. The cables of the vehicle's high-voltage electrical system are orange in color.

Vehicles with an electric motor generate much less driving noise than vehicles with internal combustion engines. As a result, your vehicle may not be heard by other road users in certain situations. This can happen, for example, when you are parking and your vehicle is not seen by other road users. This requires you to adopt a particularly anticipatory driving style, as it is necessary to allow for the possibility that other road users may behave erratically.

### Declarations of conformity

#### Vehicle components which receive and/or transmit radio waves

**USA:** "The wireless devices of this vehicle comply with Part 15 of the FCC Rules. Operation is subject to the two following two conditions: 1) These devices may not cause harmful interference, and 2) These devices must accept any interference received, including interference that may cause undesired operation. Changes or modifications not expressly approved by the party responsible for compliance could void the user's authority to operate the equipment."

**Canada:** "The wireless devices of this vehicle comply with Industry Canada license-exempt RSS standard(s). Operation is subject to the following two conditions: (1) These devices may not cause interference, and (2) These devices must accept any interference, including interference that may cause undesired operation of the device."

### Diagnostics connection

The diagnostics connection is only intended for the connection of diagnostic equipment at a qualified specialist workshop.

#### WARNING

If you connect equipment to the diagnostics connection in the vehicle, it may affect the

operation of the vehicle systems. As a result, the operating safety of the vehicle could be affected. There is a risk of an accident.

Do not connect any equipment to a diagnostics connection in the vehicle.

#### WARNING

Objects in the driver's footwell can restrict the pedal travel or obstruct a depressed pedal. The operating and road safety of the vehicle is jeopardized. There is a risk of an accident.

Make sure that all objects in the vehicle are stowed correctly, and that they cannot enter the driver's footwell. Install the floor mats securely and as specified in order to ensure sufficient clearance for the pedals. Do not use loose floor mats and do not place floor mats on top of one another.

 If the engine is switched off and equipment on the diagnostics connection is used, the starter battery may discharge.

Connecting equipment to the diagnostics connection can lead to emissions monitoring information being reset, for example. This may lead to the vehicle failing to meet the requirements of the next emissions test during the main inspection.

### Qualified specialist workshop

An authorized Mercedes-Benz Center is a qualified specialist workshop. It has the necessary specialist knowledge, tools and qualifications to correctly carry out the work required on your vehicle. This is especially the case for work relevant to safety.

Observe the notes in the Maintenance Booklet. Always have the following work carried out at an authorized Mercedes-Benz Center:

- work relevant to safety
- service and maintenance work
- repair work
- alterations, installation work and modifications
- work on electronic components
- work on the hybrid drive system

### Correct use

If you remove any warning stickers, you or others could fail to recognize certain dangers.

Leave warning stickers in position.

Observe the following information when driving your vehicle:

- the safety notes in this manual
- the vehicle technical data
- traffic rules and regulations
- laws and safety standards pertaining to motor vehicles

### Problems with your vehicle

If you should experience a problem with your vehicle, particularly one that you believe may affect its safe operation, we urge you to contact an authorized Mercedes-Benz Center immediately to have the problem diagnosed and rectified. If the problem is not resolved to your satisfaction, please discuss the problem again with a Mercedes-Benz Center or contact us at one of the following addresses.

#### In the USA

Customer Assistance Center  
Mercedes-Benz USA, LLC  
One Mercedes Drive  
Montvale, NJ 07645-0350

#### In Canada

Customer Relations Department  
Mercedes-Benz Canada, Inc.  
98 Vanderhoof Avenue  
Toronto, Ontario M4G 4C9

### Reporting safety defects

USA only:

The following text is published as required of manufacturers under Title 49, Code of U.S. Federal Regulations, Part 575 pursuant to the "National Traffic and Motor Vehicle Safety Act of 1966".

If you believe that your vehicle has a defect which could cause a crash or could cause injury or death, you should immediately inform the National Highway Traffic Safety Administration (NHTSA) in addition to notifying Mercedes-Benz USA, LLC.

If NHTSA receives similar complaints, it may open an investigation, and if it finds that a safety defect exists in a group of vehicles, it may order a recall and remedy campaign. However, NHTSA cannot become involved in individual problems between you, your dealer, or Mercedes-Benz USA, LLC.

To contact NHTSA, you may call the Vehicle Safety Hotline toll-free at 1-888-327-4236 (TTY: 1-800-424-9153); go to <http://www.safercar.gov>; or write to: Administrator, NHTSA, 400 Seventh Street, SW., Washington, DC 20590.

You can also obtain other information about motor vehicle safety from

<http://www.safercar.gov>

### Limited Warranty

**!** Follow the instructions in this manual about the proper operation of your vehicle as well as about possible vehicle damage. Damage to your vehicle that arises from culpable contraventions against these instructions is not covered either by the Mercedes-Benz Limited Warranty or by the New or Used-Vehicle Warranty.

### QR codes for the rescue card

The QR codes are secured in the fuel filler flap and on the opposite side on the B-pillar. In the event of an accident, rescue services can use the QR code to quickly find the appropriate rescue card for your vehicle. The current rescue card contains the most important information about your vehicle in a compact form, e.g. the routing of the electric cables.

You can find more information under [http://portal.aftersales.i.daimler.com/public/content/asportal/en/communication/informationen\\_fuer/QRCode.html](http://portal.aftersales.i.daimler.com/public/content/asportal/en/communication/informationen_fuer/QRCode.html).

### Data stored in the vehicle

#### Data storage

A wide range of electronic components in your vehicle contain data memories.

These data memories temporarily or permanently store technical information about:

- vehicle's operating state
- incidents
- malfunctions

In general, this technical information documents the state of a component, a module, a system or the surroundings.

These include, for example:

- operating conditions of system components, e.g. fluid levels
- the vehicle's status messages and those of its individual components, e.g. number of wheel revolutions/speed, deceleration in movement, lateral acceleration, accelerator pedal position
- malfunctions and defects in important system components, e.g. lights, brakes
- vehicle reactions and operating conditions in special driving situations, e.g. air bag deployment, intervention of stability control systems
- ambient conditions, e.g. outside temperature

This data is of an exclusively technical nature and can be used to:

- assist in recognizing and rectifying malfunctions and defects
- analyze vehicle functions, e.g. after an accident
- optimize vehicle function

The data cannot be used to trace the vehicle's movements.

When your vehicle is serviced, technical information can be read from the event data memory and malfunction data memory.

Services include, for example:

- repair services
- service processes
- warranties
- quality assurance

The vehicle is read out by employees of the service network (including the manufacturer) using special diagnostic testers. More detailed information is obtained from it, if required.

After a malfunction has been rectified, the information is deleted from the malfunction memory or is continually overwritten.

When operating the vehicle, situations are conceivable in which this technical data, in connec-

tion with other information (if necessary, under consultation with an authorized expert), could be traced to a person.

Examples include:

- accident reports
- damage to the vehicle
- witness statements

Further additional functions that have been contractually agreed upon with the customer allow certain vehicle data to be conveyed by the vehicle as well. The additional functions include, for example, vehicle location in case of an emergency.

### COMAND/mbrace

If the vehicle is equipped with COMAND or mbrace, additional data about the vehicle's operation, the use of the vehicle in certain situations, and the location of the vehicle may be compiled through COMAND or the mbrace system.

For additional information please refer to the COMAND User Manual or the Digital Operator's Manual and/or the mbrace Terms and Conditions.

### Event data recorders

This vehicle is equipped with an event data recorder (EDR). This vehicle is equipped with an event data recorder (EDR). The main purpose of an EDR is to record, in certain crash or near crash-like situations, such as an air bag deployment or hitting a road obstacle, data that will assist in understanding how a vehicle's systems performed. The EDR is designed to record data related to vehicle dynamics and safety systems for a short period of time, typically 30 seconds or less.

The EDR in this vehicle is designed to record such data as:

- How various systems in your vehicle were operating
- Whether or not the driver and passenger safety belts were buckled/fastened
- How far (if at all) the driver was depressing the accelerator and/or brake pedal and
- How fast the vehicle was traveling.



These data can help provide a better understanding of the circumstances in which accidents and injuries occur. NOTE: EDR data are recorded by your vehicle only if a non-trivial crash situation occurs; no data is recorded by the EDR under normal driving conditions and no personal data (e.g. name, gender, age and accident location) are recorded. However, other parties, such as law enforcement could combine EDR data with the type of personally identifying data routinely acquired during a crash investigation.

Access to the vehicle and/or the EDR is needed to read data that is recorded by the EDR, and special equipment is required. In addition to the vehicle manufacturer, other parties that have the special equipment, such as law enforcement, can read the information by accessing the vehicle or the EDR.

EDR data may be used in civil and criminal matters as a tool in accident reconstruction, accident claims and vehicle safety. Since the Crash Data Retrieval CDR tool that is used to extract data from the EDR is commercially available, Mercedes-Benz USA, LLC ("MBUSA") expressly disclaims any and all liability arising from the extraction of this information by unauthorized Mercedes-Benz personnel.

MBUSA will not share EDR data with others without the consent of the vehicle owners or, if the vehicle is leased, without the consent of the lessee. Exceptions to this representation include responses to subpoenas by law enforcement; by federal, state or local government; in connection with or arising out of litigation involving MBUSA or its subsidiaries and affiliates; or, as required by law.

**Warning:** The EDR is a component of the Restraint System Module. Tampering with, altering, modifying or removing the EDR component may result in a malfunction of the Restraint System Module and other systems.

State laws or regulations regarding EDRs that conflict with federal regulation are pre-empted. This means that in the event of such conflict, the federal regulation governs. As of February 2013, 13 states have enacted laws relating to EDRs.

## Information on copyright

### General information

Information on license for free and open-source software used in your vehicle and its electronic components is available on the following website:

<http://www.mercedes-benz.com/opensource>

## Cockpit

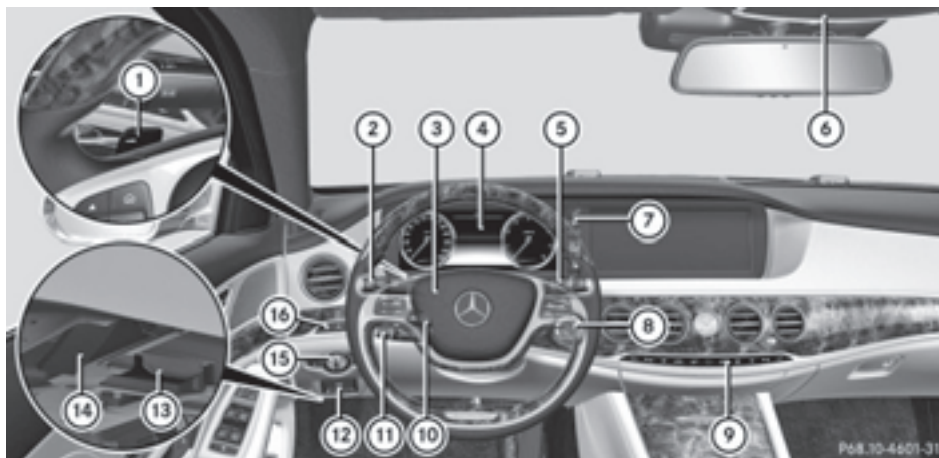

	Function	Page
①	Steering wheel paddle shifters	174
②	Combination switch	131
③	Horn	
④	Instrument cluster	33
⑤	DIRECT SELECT lever	170
⑥	Overhead control panel	39
⑦	Control panel for:	
	Lowering the rear seat head restraints	116
	Extending/retracting the rear roller sunblind	334
	PASSENGER AIR BAG indicator lamp	46
	Adjusting the brightness of the instrument lighting and the multimedia system display	
⑧	Ignition lock	162
	Start/Stop button	162

	Function	Page
⑨	Climate control systems	140
⑩	Adjusts the steering wheel	120
	Steering wheel heating	120
⑪	Cruise control lever	197
⑫	Electric parking brake	190
⑬	Diagnostics connection	28
⑭	Opening the hood	352
⑮	Light switch	130
⑯	Control panel for:	
	Activating Steering Assist and Stop&Go Pilot	207
	Switching on Active Lane Keeping Assist	237
	Deactivating PARKTRONIC	214
	Switching on the 360° camera	224
	Activating Night View Assist	230
	Switching on the head-up display	259

## Instrument cluster

## Displays



P54.33-3001-31

	Function	Page		Function	Page
①	Speedometer		⑤	Fuel gauge	
②	Multifunction display	258		Fuel filler flap location indicator  : the fuel filler cap is on the right-hand side.	
③	Tachometer	256			
④	Coolant temperature	257			

- i** Information on displaying the outside temperature in the multifunction display can be found under "Outside temperature display" (> page 257).
- i** Information on additional displays for PLUG-IN HYBRID vehicles can be found in the "PLUG-IN HYBRID operation" section (> page 242).

## Warning and indicator lamps









	Function	Page
①	ABS	316
②	ESP® OFF	317
	ESP®	317
③	Turn signal, left	131
④	Low-beam headlamps	131
⑤	High-beam headlamps	132
⑥	Parking lamps, license plate and instrument cluster lighting	131
⑦	Turn signal, right	131
⑧	Distance warning	322
⑨	Electric parking brake (yellow)	319







	Function	Page
⑩	Electric parking brake (red) USA only Canada only	319
⑪	Engine diagnostics	320
⑫	Power steering	324
⑬	Brakes (red) USA only Canada only	315
⑭	RBS (Recuperative Brake System)	315
⑮	Seat belts	313
⑯	Restraint system	45
⑰	Tire pressure monitor	323

**i** Information on additional indicator and warning lamps for PLUG-IN vehicles can be found in the "PLUG-IN HYBRID operation" section (▷ page 242).

## Multifunction steering wheel





	Function	Page
①	Multifunction display	258
②	Sets the brightness of the instrument cluster and the multimedia system display	256
③	Multimedia system display	
④	DVD changer or single DVD drive	
⑤	Multimedia system controller and buttons	
⑥	 Rejects or ends a call Exits the telephone book/redial memory  Makes or accepts a call Switches to the redial memory   Adjusts the volume  Mute  Switches on the Voice Control System	267

	Function	Page
⑦	 Opens the menu list   Selects a menu or submenu or scrolls through lists  Confirms a selection Hides display messages  Back  Switches off the Voice Control System	257 257 277 257

- i** In vehicles with multimedia system COMAND you can find further information:
- on the multimedia system in the Digital Operator's Manual
  - on the DVD changer or single DVD drive in the Digital Operator's Manual
  - on the Voice Control System in the separate operating instructions

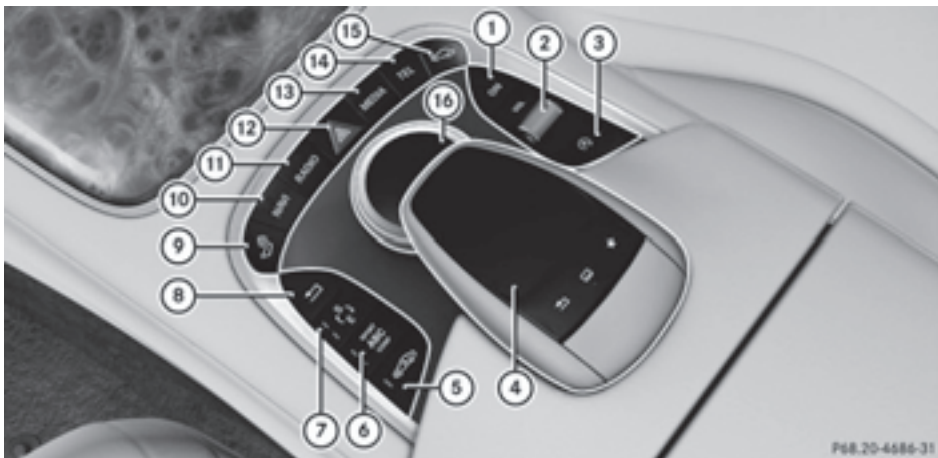
## Center console



	Function	Page		Function	Page
①	Switches multimedia system on/off (see the separate operating instructions)		⑦	 Selects the drive program/program selector button	173
②	Adjusts the volume/mute (see the separate operating instructions)			 Selects the drive program/program selector button (Mercedes-AMG vehicles)	173
③	 ECO start/stop function	167		Selects automatic drive programs E, S and E+ (vehicles with PLUG-IN HYBRID operation)	250
	 Sets the vehicle level (vehicles with PLUG-IN HYBRID operation)	210, 212	⑧	Back button (see the separate operating instructions)	
④	Touchpad (see the separate operating instructions) Telephone keypad (see the separate operating instructions)		⑨	Seat adjustment button (see the separate operating instructions)	
⑤	 Sets the vehicle level Selects the operating mode (vehicles with PLUG-IN HYBRID operation)	210 243	⑩	Navigation button (see the separate operating instructions)	
⑥	Adjusts the suspension settings	210, 212	⑪	Radio button (see the separate operating instructions)	
			⑫	 Hazard warning lamps	132
			⑬	Media button (see the separate operating instructions)	
			⑭	Telephone, address book and Internet button (see separate operating instructions)	

	Function	Page
⑮	Vehicle and system settings button (see separate operating instructions)	

**i** Information on the ECO start/stop function for vehicles with PLUG\_IN HYBRID operation can be found in the "PLUG\_IN HYBRID operation" section (> page 252).

	Function	Page
⑯	Multimedia system controller (see the separate operating instructions)	



## Overhead control panel

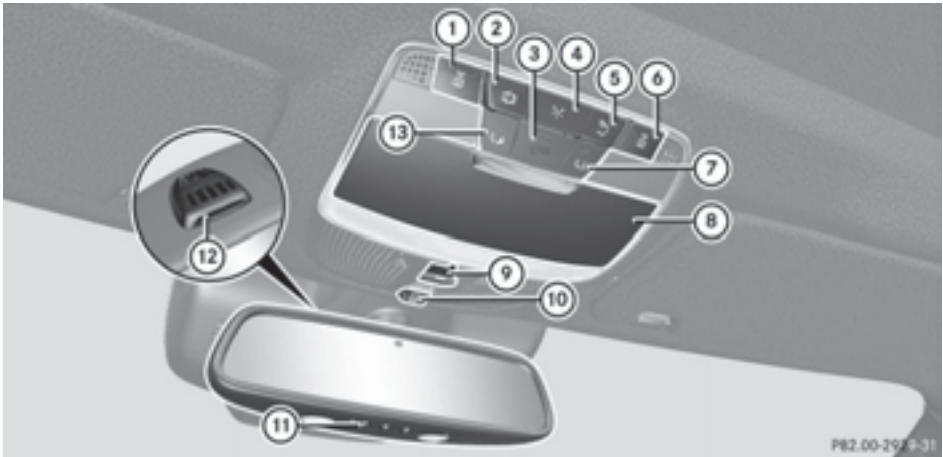

	Function	Page
①	Switches the left-hand reading lamp on/off	134
②	Switches the automatic interior lighting control on/off	135
③	SOS button (mbrace system)	341
④	Switches the front interior lighting on/off	135
⑤	Switches the rear interior lighting on/off	135
⑥	Switches the right-hand reading lamp on/off	134
⑦	MB Info call button (mbrace system)	343
⑧	Eyeglasses compartment	326
⑨	Opens/closes the panorama roof with power tilt/sliding panel	98
	Opens/closes the front roller sunblinds	100

	Function	Page
⑩	Operates MAGIC SKY CONTROL Opens/closes the rear roller sunblind	100
⑪	Buttons for the garage door opener	348
⑫	Microphone for mbrace (emergency call system), telephone and the Voice Control System; see the separate operating instructions	
⑬	Roadside Assistance call button (mbrace system)	342

## Door control panel

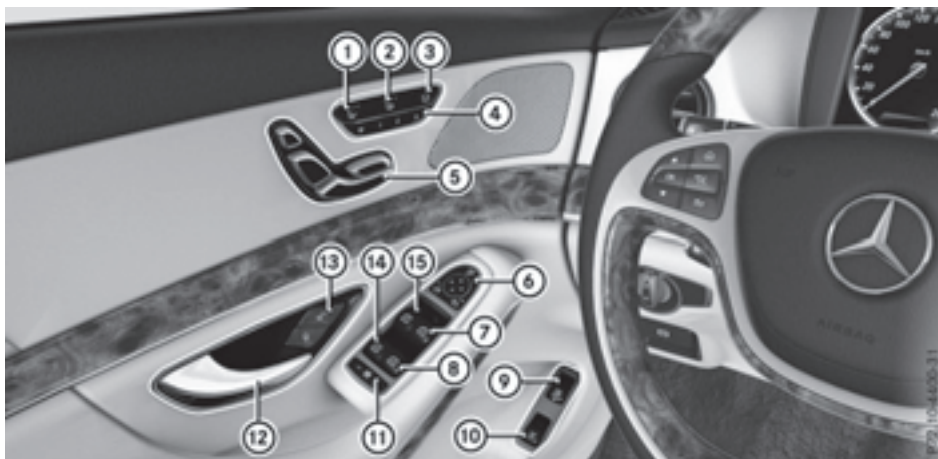

	Function	Page
①	Seat ventilation	119
②	Seat heating	118
③	Adjusts the front-passenger seat from the driver's seat	108
④	<b>M</b> <b>1</b> <b>2</b> <b>3</b> Stores settings for the seat, exterior mirrors and steering wheel	126
⑤	Adjusts the seats electrically	106
⑥	Adjusts and folds the exterior mirrors in/out electrically	123
⑦	Opens/closes the right side window	94
⑧	Opens/closes the rear right side window	94

	Function	Page
⑨	Unlocks fuel filler flap	179
⑩	Opens/closes the trunk lid	92
⑪	Override feature for the controls in the rear compartment	67
⑫	Opens the door	86
⑬	Unlocks/locks the vehicle	86
⑭	Opens/closes the rear left side window	94
⑮	Opens/closes the left side window	94

## Rear seats



**i** Example: vehicles with Rear Seat Entertainment System

	Function	Page
①	DVD player (see the separate operating instructions)	
②	Cigarette lighter Socket	335 336
③	Cup holder	331
④	Stowage compartment in the rear seat armrest	327
⑤	Stowage box in the seat backrest	328
	Coolbox	339

## Useful information

- i** This Operator's Manual describes all models and all standard and optional equipment of your vehicle available at the time of publication of the Operator's Manual. Country-specific differences are possible. Please note that your vehicle may not be equipped with all features described. This also applies to safety-related systems and functions.
- i** Read the information on qualified specialist workshops (> page 28).

## Hybrid vehicles

### General notes

Hybrid technology combines a fuel efficient internal combustion engine with a powerful electric motor.

### Important safety notes

#### Danger of electric shock

##### DANGER

The vehicle's high-voltage electrical system is under high voltage. If you modify components in the vehicle's high-voltage electrical system or touch damaged components, you may be electrocuted. The components in the vehicle's high-voltage electrical system may be damaged in an accident, although the damage is not visible. There is a risk of fatal injury.

Following an accident, do not touch any high-voltage components and never modify the vehicle's high-voltage electrical system. Have the vehicle towed away after an accident and the vehicle's high-voltage electrical system checked by a qualified specialist workshop.

When towing a vehicle after an accident, be sure to observe the following sections:

- Transporting the vehicle (> page 381)
- Towing a vehicle with both axles on the ground (> page 380)

Read the safety instructions on towing and tow-starting (> page 379).



All components of the hybrid drive system are marked with yellow warning stickers that warn you of the danger of high voltage. The cables of the vehicle's high-voltage electrical system are orange in color.

The ignition must be switched off when carrying out general tasks, such as adding washer fluid to the windshield washer system or checking the coolant level.

#### Automatic switching off of the hybrid drive system

If components of the restraint system are activated during an accident, the hybrid drive system is automatically deactivated.

The hybrid drive system is not activated when the vehicle is started if:

- an electrical short circuit is detected in the hybrid drive system
- an electrical connection in the hybrid drive system is disconnected

This ensures that you do not come into contact with high voltage.

#### Manual switching off of the hybrid drive system

The hybrid drive system can be deactivated manually using the high voltage switch-off device.

**!** To prevent damage to the hybrid drive system please observe the following instructions:

- only deactivate the hybrid drive system manually in the following situations.
- work on the hybrid drive system may only be carried out at a qualified specialist workshop, even when it has been deactivated manually.

Deactivate the hybrid system manually if:

- the  restraint system warning lamp in the instrument cluster lights up after an accident
- the vehicle is badly damaged, e.g. after an accident, and the restraint system components were not activated
- the vehicle is badly damaged and has to be towed or transported

▶ **If possible, move the vehicle out of the danger zone:** shift the automatic transmission into position **N**.

▶ Release the electric parking brake.

▶ Roll the vehicle to a safe place and park it safely.

Get assistance from others if necessary.

**i** The vehicle is locked automatically when the ignition is switched on and the wheels are turning. There is therefore a risk of being locked out if the vehicle is being pushed or tested on a dynamometer.

▶ Switch the ignition off.

▶ Shift the automatic transmission to park position **P** (▷ page 170).

Depress the electric parking brake (▷ page 190).

Secure the vehicle against rolling away (▷ page 406).

▶ **To use the high-voltage switch-off device:** open the trunk lid.

▶ Lift the trunk floor upwards (▷ page 329).

▶ Remove the right-hand paneling in the trunk.



▶ Press release clip ① in the direction of the arrow and pull it out.

▶ Pull the high voltage switch-off device ② apart until it engages in the stop position.

If the hybrid drive system has been deactivated due to reasons mentioned above, have it

checked at a qualified specialist workshop before reactivation.

## High-voltage battery

### WARNING

In the event of a vehicle fire, the internal pressure of the high-voltage battery can exceed a critical value. In this case flammable gas escapes through a ventilation valve on the underbody. The gas can ignite. There is a risk of injury.

Leave the danger zone immediately. Secure the danger area at a suitable distance, whilst observing legal requirements.

### WARNING

If the housing of the high-voltage battery has been damaged, electrolyte and gases may leak out. These are poisonous and caustic. There is a risk of injury.

Avoid contact with skin, eyes or clothing. Immediately rinse electrolyte splashes off with water and seek medical attention straight away.

**!** Exhaustive discharge caused by the vehicle standing idle for lengthy periods can damage the high-voltage battery.

**Hybrid vehicles:** if the vehicle is idle for lengthy periods, run it for a few minutes once every six weeks to charge up the high-voltage battery. During the charging process, switch off all electrical consumers, e.g. the automatic climate control or the seat heating.

**PLUG-IN HYBRID vehicles:** make sure that the high-voltage battery is connected to a charging station during long periods when the vehicle is standing idle.

**PLUG-IN HYBRID vehicles:** charging the high-voltage battery (▷ page 180).

## Engine compartment

Before opening the hood:

▶ Apply the electric parking brake.

▶ Shift the automatic transmission to park position **P**.

▶ Switch the ignition off.

- ▶ Remove the Start/Stop button from the ignition lock (▷ page 162).
- or
- ▶ If the SmartKey is inserted in the ignition lock: remove the SmartKey from the ignition lock.
- ▶ Observe the warning notes on the risk of electric shock (▷ page 42).
- ▶ Observe the warning notices about the hood (▷ page 352).

### RBS driving safety system (Recuperative Brake System)

The Recuperative Brake System supports you when braking with an electronically-controlled brake boost mode and enables the recovery of kinetic energy (recuperation).

#### WARNING





If the Recuperative Braking System malfunctions, braking resistance may be reduced and brake pedal travel may be longer than usual. If you subsequently depress the brake pedal as usual, the braking effect may not be sufficient. There is a risk of an accident.

In the event of this malfunction, continue to depress the brake pedal. Stop the vehicle in accordance with the traffic conditions. If necessary, contact a qualified specialist workshop.

Further information about the Recuperative Brake System (▷ page 240).

### Panic alarm



- ▶ **To activate:** press  button  for at least one second.  
A visual and audible alarm is triggered if the alarm system is armed.
- ▶ **To deactivate:** press  button  again.
- or
- ▶ Press the Start/Stop button.  
The SmartKey must be in the vehicle.

## Occupant safety

### Introduction to the restraint system

The restraint system can reduce the risk of vehicle occupants coming into contact with parts of the vehicle's interior in the event of an accident. The restraint system can also reduce the forces to which vehicle occupants are subjected during an accident.

The restraint system comprises:

- seat belt system
- air bags
- child restraint system
- child seat securing systems

The components of the restraint system work in conjunction with each other. They can only deploy their protective function if, at all times, all vehicle occupants:

- have fastened their seat belts correctly (▷ page 48)
- have adjusted their seat and head restraint properly (▷ page 105).

As the driver, you also have to make sure that the steering wheel is adjusted correctly. Observe the information relating to the correct driver's seat position (▷ page 104).

You also have to make sure that an air bag can inflate properly if deployed (▷ page 50).

An air bag supplements a correctly worn seat belt. As an additional safety device, the air bag increases the level of protection for vehicle occupants in the event of an accident. For example, if, in the event of an accident, the protection offered by the seat belt is sufficient, the air bags are not deployed. When an accident occurs, only the air bags that increase protection in that particular accident situation are deployed. However, seat belts and air bags generally do not protect against objects penetrating the vehicle from the outside.

Information on restraint system operation can be found under "Triggering of the Emergency Tensioning Devices and air bags" (▷ page 57). For information on children traveling with you in the vehicle and on child restraint systems, see "Children in the vehicle" (▷ page 61).

### Important safety notes

#### WARNING

Modifications to the restraint system may cause it to no longer work as intended. The restraint system may then not perform its intended protective function and may fail in an accident or trigger unexpectedly, for example. This poses an increased risk of injury or even fatal injury.

Never modify parts of the restraint system. Never tamper with the wiring, the electronic components or their software.

If it is necessary to modify an air bag system to accommodate a person with disabilities, contact an authorized Mercedes-Benz Center for details. USA only: for further information contact our Customer Assistance Center at 1-800-FOR-MERCEdes (1-800-367-6372).

### Restraint system warning lamp

The functions of the restraint system are checked after the ignition is switched on and at regular intervals while the engine is running. Therefore, malfunctions can be detected in good time.

The  restraint system warning lamp in the instrument cluster lights up when the ignition is switched on. It goes out no later than a few seconds after the vehicle is started. The components of the restraint system are in operational readiness.

A malfunction has occurred if the  restraint system warning lamp:

- does not light up after the ignition is switched on
- does not go out after a few seconds with the engine running
- lights up again while the engine is running

**All vehicles, except hybrid vehicles:**

#### WARNING

If restraint system is malfunctioning, restraint system components may be triggered unintentionally or might not be triggered at all in the event of an accident with a high rate of vehicle deceleration. This can affect the Emergency Tensioning Device or air bag, for example. This poses an increased risk of injury or even fatal injury.

Have the restraint system checked and repaired in a qualified specialist workshop as soon as possible.

### Hybrid vehicles:

#### DANGER

If the restraint system is malfunctioning, individual restraint system components may be triggered unintentionally or might not be triggered at all in the event of an accident with a high rate of vehicle deceleration. This could affect Emergency Tensioning Devices or air bags, for example. The vehicle's high-voltage electrical system may also not be deactivated as intended in the event of an accident. You could suffer an electric shock if you touch the damaged components of the vehicle's high-voltage electrical system. This poses an increased risk of injury or even fatal injury.

Have the restraint system checked and repaired immediately at a qualified specialist workshop. Immediately switch off the ignition and remove the SmartKey from the ignition lock after an accident.

## PASSENGER AIR BAG indicator lamp



PASSENGER AIR BAG ON indicator lamp ① and PASSENGER AIR BAG OFF indicator lamp ② are part of the Occupant Classification System (OCS).

The indicator lamps display the status of the front-passenger front air bag.

- PASSENGER AIR BAG ON lights up: the front-passenger front air bag is enabled. If, in the event of an accident, all deployment criteria are met, the front-passenger front air bag is deployed.
- PASSENGER AIR BAG OFF lights up: the front-passenger front air bag is deactivated. It will then not be deployed in the event of an accident.

Depending on the person in the front-passenger seat, the front-passenger front air bag must either be deactivated or enabled; see the following points. You must make sure of this both before and during a journey.

- **Children in a child restraint system:** whether the front-passenger front air bag is enabled or deactivated depends on the installed child restraint system, and the age and size of the child. Therefore, be sure to observe the notes on the "Occupant Classification System (OCS)" (▷ page 53) and on "Children in the vehicle" (▷ page 61). There you will also find instructions on rearward and forward-facing child restraint systems on the front-passenger seat.
- **All other persons:** depending on the classification of the person in the front-passenger seat, the front-passenger front air bag is enabled or deactivated (▷ page 53). Be sure to observe the notes on "Seat belts" (▷ page 46) and "Air bags" (▷ page 50). There you can also find information on the correct seat position.

## Seat belts

## Introduction

Seat belts are the most effective means of restricting the movement of vehicle occupants in the event of an accident or the vehicle rolling over. This reduces the risk of vehicle occupants coming into contact with parts of the vehicle interior or being ejected from the vehicle. Furthermore, the seat belt helps to keep the vehicle occupant in the best position in relation to the air bag.

The seat belt system comprises:

- Seat belts
- Emergency Tensioning Devices for the front seat belts and the outer seat belts in the rear
- Seat belt force limiters for the front seat belts and the outer seat belts in the rear
- Belt bags for the outer seat belts in the rear, depending on the vehicle's equipment

If the seat belt is pulled out of the belt outlet quickly or with a jerky movement, the belt retractor locks. The belt strap cannot be extracted any further.

The Emergency Tensioning Device tightens the seat belt in an accident, pulling the belt close against the body. However it does not pull the vehicle occupant back in the direction of the backrest.

The Emergency Tensioning Device does not correct an incorrect seat position or the routing of an incorrectly fastened seat belt.

When triggered, a seat belt force limiter helps to reduce the force exerted by the seat belt on the vehicle occupant.

The seat belt force limiters for the front seats are synchronized with the front air bags, which absorb part of the deceleration force. This can reduce the force exerted on the vehicle occupants during an accident.

- ❗ If the front-passenger seat is unoccupied, do not insert the belt tongue into the buckle of the front-passenger seat. This may otherwise lead to the triggering of the Emergency Tensioning Device in the event of an accident, which will then need to be replaced.



## Important safety notes

The use of seat belts and child restraint systems is required by law in:

- all 50 states
- the U.S. territories
- the District of Columbia
- all Canadian provinces

Even where this is not required by law, all vehicle occupants should correctly fasten their seat belts before starting the journey.

### WARNING

If the seat belt is incorrectly fastened, it cannot protect as intended. Furthermore, an incorrectly fastened seat belt can cause additional injury, for example, in an accident, during braking or when abruptly changing direction. This poses an increased risk of injury or even fatal injury.

Make sure that all vehicle occupants are seated properly with a correctly fastened seat belt.

### WARNING

The seat belt does not offer the intended level of protection if you have not moved the backrest to an almost vertical position. When braking or in the event of an accident, you could slide underneath the seat belt and sustain abdomen or neck injuries, for example. This poses an increased risk of injury or even fatal injury.

Adjust the seat properly before beginning your journey. Always ensure that the backrest is in an almost vertical position and that the shoulder section of your seat belt is routed across the center of your shoulder.

### WARNING

Objects next to the front seat that block the belt buckle or the moving belt anchorage on the front seat impair the function of the Emergency Tensioning Devices. The Emergency Tensioning Devices may not function as intended and the seat belt may no longer provide the intended protection. This poses an increased risk of injury or even fatal injury.

Before starting the journey, make sure that there are no objects around the belt buckle or between the front seat and door.

### WARNING

Persons under 5 ft (1.50 m) in height cannot fasten the seat belt correctly without an additional suitable restraint system. If the seat belt is incorrectly fastened, it cannot protect as intended. Furthermore, an incorrectly fastened seat belt can cause additional injury, for example, in an accident, during braking or an abrupt change of direction. This poses an increased risk of injury or even fatal injury.

For this reason, always secure persons under 5 ft (1.50 m) in height in suitable restraint systems.

If a child younger than twelve years old and under 5 ft (1.50 m) in height is traveling in the vehicle:

- always secure the child in a child restraint system suitable for this Mercedes-Benz vehicle. The child restraint system must be appropriate to the age, weight and size of the child
- always observe the instructions and safety notes on the belt bags for the outer seat belts in the rear (> page 48)
- always observe the instructions and safety notes on "Children in the vehicle" (> page 61) in addition to the child restraint system manufacturer's installation and operating instructions
- be sure to observe the instructions and safety notes on the "Occupant classification system (OCS)" (> page 53)

### WARNING

The seat belts may not perform their intended protective function if:

- they are damaged, modified, extremely dirty, bleach or dyed
- the seat belt buckle is damaged or extremely dirty
- the Emergency Tensioning Devices, belt anchorages or inertia reels have been modified

Seat belts may sustain non-visible damage in an accident, e.g. due to glass splinters. Modified or damaged seat belts may tear or fail, e.g. in an accident. Modified Emergency Tensioning Devices could accidentally trigger or fail to deploy when necessary. This poses an increased risk of injury or even fatal injury.

Never modify the seat belts, Emergency Tensioning Devices, belt anchorages or inertia reels. Make sure that the seat belts are undamaged, not worn out and clean. Following an accident, have the seat belts checked immediately at a qualified specialist workshop.

Only use seat belts that have been approved for your vehicle by Mercedes-Benz.

### Proper use of the seat belts

Pay attention to the safety notes about the seat belt (▷ page 47).

All vehicle occupants must fasten the seat belt correctly before setting off. Make sure that all occupants are wearing their seat belts correctly for the entire journey.

When fastening the seat belt, make sure that:

- The seat belt tongue is inserted into the belt buckle that belongs to the seat.
- The seat belt is tightened across your body. Avoid wearing bulky clothing, e.g. a winter coat.
- The seat belt is not twisted. Only then can the forces produced in the event of an accident be evenly distributed across the belt.
- The shoulder section of the belt must always be routed across the center of the shoulder. The shoulder section of the belt should not come into contact with your neck and must not be routed under the arm. Where possible, adjust the seat belt to the appropriate height.
- The lap belt must be taut and as low as possible over your lap.

The lap belt must always pass across your hip joints and never across your stomach or abdomen. Pregnant women must take particular care. If necessary, the lap belt can be pushed down across the hip joints and pulled tight using the shoulder section.

- The seat belt is not routed over sharp, pointed or fragile objects.

If these items are on or in your clothing, e.g. eyeglasses, pens, keys, etc., stow these items in a more suitable location.

- Only one person should use each seat belt at any one time.

On no account should babies or children travel sitting on the lap of another vehicle occupant. During an accident, they could be crushed between the occupant and seat belt.

- Objects are not secured with a seat belt if the seat belt is being used by one of the vehicle's occupants.

Also make sure that there are no objects, e.g. cushions, between the occupant and the seat.

Seat belts are solely intended for the protection and restraint of the vehicle occupants. To secure objects, luggage or loads, always observe the "Loading guidelines" (▷ page 325).

### Rear beltbags

- **i** Observe the "Important safety notes" section (▷ page 50).

Depending on the vehicle's equipment, the outer rear seat belts are equipped with a belt bag. This can be seen from the BELTBAG identification on the rear seat belt.

#### WARNING

In an accident, the belt bag may damage a non-approved child restraint system. As a result, the child restraint system may not be able to provide the intended level of protection. This poses an increased risk of injury or even fatal injury.

For this reason, a child restraint system with an integrated seat belt should always be installed using LATCH-type (ISOFIX). In a vehicle with optional belt bags for the rear seats, you should only ever use a booster seat with integrated backrest that has been tested and approved by Mercedes-Benz in conjunction with a belt bag. Never use a seat belt equipped with a belt bag to secure a forward or rearward-facing child restraint system or a booster seat that has not been approved. For information on approved child restraint systems,

please contact an authorized Mercedes-Benz Center.

Further information on child restraint systems (> page 61).



When triggered, belt bags ① open, increasing the protected area of the occupants' ribcages. The belt bags are triggered depending on the type and severity of the accident.

### Fastening and adjusting the seat belts

Observe the safety notes on the seat belt (> page 47) and the notes on correct use of seat belts (> page 48).



Basic illustration

- ▶ Adjust the seat (> page 104). The seat backrest must be in an almost vertical position.
- ▶ Pull the seat belt smoothly from the belt outlet. The seat belt on the driver's seat and the front-passenger seat may be tightened automatically, see "Belt adjustment" (> page 50).
- ▶ If necessary, pull upwards on the shoulder section of the seat belt to tighten the belt across your body.

The shoulder section of the seat belt must always be routed across the center of the shoulder. Adjust the belt outlet if necessary.

- ▶ **To raise:** slide the belt outlet upwards. The belt outlet will engage in various positions.
- ▶ **To lower:** hold belt outlet release ③ and slide belt outlet downwards.
- ▶ Let go of belt outlet release ③ in the desired position and make sure that the belt outlet engages.

All seat belts except the driver's seat belt are equipped with a special seat belt retractor to securely fasten child restraint systems in the vehicle. Further information can be found under "Special seat belt retractor" (> page 62).

### Rear seat belt buckle extenders

The seat belt extender is an integral part of the PRE-SAFE® convenience function. It is used on the outer rear seats.

Always ensure that it is possible to move the belt buckle freely. Always stow objects in the vehicle correctly.

To assist you in finding the seat belt buckle and fastening the seat belt:

- the belt buckle moves forwards to a convenient position
- the belt buckle is illuminated

After the seat belt is fastened, the belt buckle returns to its normal position. The seat belt then lies tight across the lap and thorax areas.

**Incorporation into the PRE-SAFE® system:** the belt buckle is lowered quickly in certain hazardous situations. This pre-tensions the seat belt.

**Incorporation into the automatic measures after the accident:** in this situation, the belt

buckle is illuminated and extended after a rear door is opened.

## Releasing seat belts

**!** Make sure that the seat belt is fully rolled up. Otherwise, the seat belt or belt tongue will be trapped in the door or in the seat mechanism. This could damage the door, the door trim panel and the seat belt. Damaged seat belts can no longer fulfill their protective function and must be replaced. Visit a qualified specialist workshop.

- ▶ Press the release button in the belt buckle, hold the belt tongue firmly and guide the belt back.

## Seat belt adjustment

The seat-belt adjustment is an integral part of the PRE-SAFE® convenience function. This function adjusts the driver's and front-passenger seat belt to the upper body of the occupants.

The belt strap is tightened slightly when:



- the belt tongue is engaged in the buckle and
- the ignition is switched on

The seat-belt adjustment will apply a certain retraction force if any slack is detected between the vehicle occupant and the seat belt. Do not hold on to the seat belt tightly while it is adjusting.

You can switch the seat-belt adjustment on and off using the multimedia system. Information on activating and deactivating the seat-belt adjustment function can be found in the Digital Operator's Manual.

## Belt warning for the driver and front passenger

The  seat belt warning lamp in the instrument cluster is a reminder that all vehicle occupants must wear their seat belts. It may light up continuously or flash. In addition, there may be a warning tone.

Regardless of whether the driver's seat belt has already been fastened, the  seat belt warning lamp lights up for six seconds each time the engine is started. If, after six seconds, the driver or front-passenger seat belt has not been fastened and the doors are closed, the  seat belt warning lamp lights up. As soon as the driver's and front-passenger seat belts are fastened

or a front door is opened again, the  seat belt warning lamp goes out.

If the driver's seat belt is not fastened after the engine is started, an additional warning tone will sound. The warning tone switches off after six seconds or once the driver's seat belt is fastened.

If the vehicle's speed exceeds 15 mph (25 km/h) once and the driver's and front-passenger seat belts are not fastened, a warning tone sounds. A warning tone also sounds with increasing intensity for 60 seconds or until the driver or front passenger have fastened their seat belts.

If the driver or front passenger unfasten their seat belts during the journey, the seat belt warning is activated again.

## Air bags

### Introduction

The air bag installation point is identified by the label AIR BAG.

An air bag supplements a correctly fastened seat belt. However, it is not intended as a substitute for the seat belt. Air bags provide additional protection in the event of an accident.

Not all air bags are deployed in an accident. The various air bag systems work independently of each other (▷ page 57).

There is, however, no system available today that can completely rule out injury or death.

It is also not possible to rule out a risk of injury caused by an air bag due to the high speed at which the air bag must be deployed.

## Important safety notes

### WARNING

If you do not sit in the correct seat position, the air bag cannot protect as intended and could even cause additional injury when deployed. This poses an increased risk of injury or even fatal injury.

To avoid hazardous situations, always make sure that all of the vehicle's occupants:

- have fastened their seat belts correctly, including pregnant women
- are sitting correctly and maintain the greatest possible distance to the air bags
- follow the following instructions

Always make sure that there are no objects between the air bag and the vehicle's occupants.

- Adjust the seats properly before beginning your journey. Always make sure that the seat is in an almost upright position. The center of the head restraint must support the head at about eye level.
- Move the driver's and front-passenger seats as far back as possible. The driver's seat position must allow the vehicle to be driven safely.
- Only hold the steering wheel on the outside. This allows the air bag to be fully deployed.
- Always lean against the backrest while driving. Do not lean forwards or lean against the door or side window. You may otherwise be in the deployment area of the air bags.
- Always keep your feet in the footwell in front of the seat. Do not put your feet on the dashboard, for example. Your feet may otherwise be in the deployment area of the air bag.
- For this reason, always secure persons less than 5 ft (1.50 m) tall in suitable restraint systems. Up to this height, the seat belt cannot be worn correctly.

**If a child is traveling in your vehicle, also observe the following notes:**

- Always secure children under twelve years of age and less than 5 ft (1.50 m) tall in suitable child restraint systems.
- Child restraint systems should be installed on the rear seats.
- Only secure a child in a rearward-facing child restraint system on the front-passenger seat when the front-passenger front air bag is deactivated. If the PASSENGER AIR BAG OFF indicator lamp is permanently lit, the front-passenger front air bag is deactivated (▷ page 46).
- Always observe the instructions and safety notes on the "Occupant Classification System (OCS)" (▷ page 53) and on "Children in the

vehicle" (▷ page 61) in addition to the child restraint system manufacturer's installation and operating instructions.

**Objects in the vehicle interior may prevent an air bag from functioning correctly.** Before starting your journey and to avoid risks resulting from the speed of the air bag as it deploys, make sure that:

- there are no people, animals or objects between the vehicle occupants and an air bag.
- there are no objects between the seat, door and B-pillar.
- no hard objects, e.g. coat hangers, hang on the grab handles or coat hooks.
- no accessories, such as cup holders, are attached to the vehicle within the deployment area of an air bag, e.g. to doors, side windows, rear side trim or side walls.
- no heavy, sharp-edged or fragile objects are in the pockets of your clothing. Store such objects in a suitable place.

#### **WARNING**

If you modify the air bag cover or affix objects such as stickers to it, the air bag can no longer function correctly. There is an increased risk of injury.

Never modify an air bag cover or affix objects to it.

#### **WARNING**

Sensors to control the air bags are located in the doors. Modifications or work not performed correctly to the doors or door paneling, as well as damaged doors, can lead to the function of the sensors being impaired. The air bags might therefore not function properly anymore. Consequently, the air bags cannot protect vehicle occupants as they are designed to do. There is an increased risk of injury.

Never modify the doors or parts of the doors. Always have work on the doors or door paneling carried out at a qualified specialist workshop.

## Front air bags



Driver's air bag ① deploys in front of the steering wheel. Front-passenger front air bag ② deploys in front of and above the glove box. When deployed, the front air bags offer additional head and thorax protection for the occupants in the front seats.

The PASSENGER AIR BAG OFF and PASSENGER AIR BAG ON indicator lamps inform you about the status of the front-passenger air bag (▷ page 46).

The front-passenger front air bag will only deploy if:

- the system, based on the OCS weight sensor readings, detects that the front-passenger seat is occupied (▷ page 53). The PASSENGER AIR BAG ON indicator lamp is lit (▷ page 54)
- the restraint system control unit predicts a high accident severity

## Driver's knee bag



Driver's knee bag ① deploys under the steering column. The driver's knee bag is always deployed along with the driver's front air bag.

The driver's knee bag offers additional thigh, knee and lower leg protection for the occupant in the driver's seat.

## Side impact air bags

### ⚠ WARNING

Unsuitable seat covers could restrict or even prevent the deployment of the air bags integrated into the seats. Consequently, the air bags cannot protect vehicle occupants as they are designed to do. In addition, the function of the Occupant Classification System (OCS) could be restricted. This poses an increased risk of injury or even fatal injury. You should only use seat covers that have been approved for the respective seat by Mercedes-Benz.



Front side impact air bags ① and rear side impact air bags ② deploy next to the outer bolster of the seat backrest.

When deployed, the side impact air bag offers additional thorax protection. It also offers additional pelvis protection for occupants in the front seats. However, it does not protect the:

- head
- neck
- arms

In the event of a side impact, the side impact air bag is deployed on the side on which the impact occurs.

The side impact air bag on the front-passenger side (front) deploys under the following conditions:

- the OCS system detects that the front-passenger seat is occupied or
- the belt tongue is engaged in the belt buckle of the front-passenger seat

If the belt tongue is engaged in the belt buckle, the side impact air bag on the front-passenger side deploys if an appropriate accident situation occurs. In this case, deployment is independent of whether the front-passenger seat is occupied or not.

### Window curtain air bags

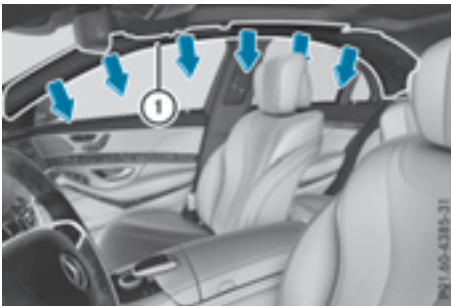

Window curtain air bags ① are integrated into the side of the roof frame and deployed in the area from the A-pillar to the C-pillar.

When deployed, the window curtain air bag enhances the level of protection for the head. However, it does not protect the chest or arms. In the event of a side impact, the window curtain air bag is deployed on the side on which the impact occurs.

If the system determines that they can offer additional protection to that provided by the seat belt, a window curtain air bag may be deployed in other accident situations (▷ page 57).

### Cushion air bags

**i** Observe the "Important safety notes" section (▷ page 50).

The rear reclining seat is equipped with a cushion air bag. If the seat backrest is reclined, the cushion air bag can provide additional occupant protection in the event of frontal collision situations. When triggered, the cushion air bag deploys under the seat cushion. This helps pre-

vent the occupant from slipping off the seat cushion.

#### **⚠ WARNING**

If a child restraint system is installed and the seat backrest is reclined too far backwards, the cushion air bag may deploy by mistake in the event of an accident. There is an increased risk of injury.

When using a child restraint system, always ensure that the seat is correctly adjusted and that the backrest is almost vertical.

If you install a child restraint system on the rear reclining seat, always observe:

- the instructions and safety notes in "Children in the vehicle" (▷ page 61)
- the child restraint system manufacturer's installation instructions

### Occupant Classification System (OCS)

#### Introduction

The Occupant Classification System (OCS) categorizes the person in the front-passenger seat. Depending on that result, the front-passenger front air bag is either enabled or deactivated.

The system does not deactivate:

- the side impact air bag
- the window curtain air bag
- the Emergency Tensioning Devices

#### Prerequisites

To be classified correctly, the front passenger must sit:

- with the seat belt fastened correctly
- in an almost upright position with their back against the seat backrest
- with their feet resting on the floor, if possible

If the front passenger does not observe these conditions, OCS may produce a false classification, e.g. because the front passenger:

- transfers their weight by supporting themselves on a vehicle armrest
- sits in such a way that their weight is raised from the seat cushion

If it is absolutely necessary to install a child restraint system on the front-passenger seat, be sure to observe the correct positioning of the child restraint system. Never place objects under or behind the child restraint system, e.g. cushions. Fully retract the seat cushion length. The entire base of the child restraint system must always rest on the seat cushion of the front-passenger seat. The backrest of the forward-facing child restraint system must lie as flat as possible against the backrest of the front-passenger seat.

The child restraint system must not touch the roof or be subjected to a load by the head restraint. Adjust the angle of the seat backrest and the head restraint position accordingly.

Only then can OCS be guaranteed to function correctly. Always observe the child restraint system manufacturer's installation and operating instructions.

### Occupant Classification System operation (OCS)



① PASSENGER AIR BAG ON indicator lamp

② PASSENGER AIR BAG OFF indicator lamp

The indicator lamps indicate whether the front-passenger front air bag is activated or deactivated.

- ▶ Press the start/stop button once or twice, or turn the SmartKey to position **1** or **2** in the ignition lock.

The system carries out a self-diagnosis test.

The PASSENGER AIR BAG OFF and PASSENGER AIR BAG ON indicator lamps must light up simultaneously for about six seconds.

The indicator lamps then display the status of the front-passenger front air bag:

- PASSENGER AIRBAG ON lights up: the front-passenger front airbag is enabled. If, in the

case of an accident, all deployment criteria are met, the front-passenger front air bag is deployed.

- PASSENGER AIRBAG OFF lights up: the front-passenger front airbag is disabled. It will then not be deployed in the event of an accident.

If the status of the front-passenger front air bag changes whilst the vehicle is in motion, an air bag display message may appear in the instrument cluster (▶ page 289). Always observe the PASSENGER AIR BAG ON and PASSENGER AIR BAG OFF indicator lamps when the front-passenger seat is occupied. Make sure that the status of the front-passenger front air bag is correct before and during a journey.

#### WARNING

If the PASSENGER AIR BAG OFF indicator lamp is lit, the front-passenger front air bag is disabled. It will not be deployed in the event of an accident and cannot perform its intended protective function. A person in the front-passenger seat could then, for example, come into contact with the vehicle's interior, especially if the person is sitting too close to the dashboard. This poses an increased risk of injury or even fatal injury.

When the front-passenger seat is occupied, always ensure that:

- the classification of the person in the front-passenger seat is correct and the front-passenger front air bag is enabled or disabled in accordance with the person in the front-passenger seat
- the front-passenger seat has been moved back as far back as possible.
- the person is seated correctly.

Make sure, both before and during the journey, that the status of the front-passenger front air bag is correct.

#### WARNING

If you secure a child in a rearward-facing child restraint system on the front-passenger seat and the PASSENGER AIR BAG ON indicator lamp is lit up, the front-passenger front air bag may deploy in an accident. The child could be



struck by the air bag. This poses an increased risk of injury or even fatal injury.

Make sure that the front-passenger front air bag has been disabled. The PASSENGER AIR BAG OFF indicator lamp must be lit.

If the PASSENGER AIR BAG OFF indicator lamp remains off and/or the PASSENGER AIR BAG ON indicator lamp is lit, do not fit a rearward-facing child restraint system to the front-passenger seat. For more information, see "Problems with the Occupant Classification System (OCS)" (▷ page 57).

### WARNING

If you secure a child in a forward-facing child restraint system on the front-passenger seat and you position the front-passenger seat too close to the dashboard, in the event of an accident, the child could:

- come into contact with the vehicle's interior if the PASSENGER AIR BAG OFF indicator lamp is lit, for example
- be struck by the air bag if the PASSENGER AIR BAG ON is lit up

This poses an increased risk of injury or even fatal injury.

Always move the front-passenger seat as far back as possible and fully retract the seat cushion length. Always make sure that the shoulder belt strap is correctly routed from the vehicle belt sash guide to the shoulder belt guide on the child restraint system. The shoulder belt strap must be routed forwards and downwards from the vehicle belt sash guide. If necessary, adjust the vehicle belt sash guide and the front-passenger seat accordingly. Always observe the child restraint system manufacturer's installation instructions.

If OCS detects that:

- the front-passenger seat is not occupied, the PASSENGER AIR BAG OFF indicator lamp lights up continuously after the system's self-diagnosis test. This indicates that the front-passenger front air bag is deactivated.
- the front-passenger seat is occupied by a child aged up to twelve months in a standard

child restraint system, the PASSENGER AIR BAG OFF indicator lamp lights up continuously after the system's self-diagnosis test. This indicates that the front-passenger front air bag is deactivated.

In the case of a twelve-month-old child in a standard child restraint system, the PASSENGER AIR BAG ON indicator lamp may light up continuously after the system's self-diagnosis test. This indicates that the front-passenger front air bag is activated. Categorization is dependent on the type of child restraint system and the stature of the child, for example. In this case, always install the child restraint system on a suitable rear seat.

- the front-passenger seat is occupied by a person of smaller stature (e.g. a teenager or a small adult), either the PASSENGER AIR BAG ON or PASSENGER AIR BAG OFF indicator lamp lights up continuously after the system's self-diagnosis test depending on the categorization.
  - If the PASSENGER AIR BAG ON indicator lamp is lit, position the front-passenger seat as far back as possible. Alternatively, a person of smaller stature can sit on a rear seat.
  - If the PASSENGER AIR BAG OFF indicator lamp lights up, a person of smaller stature should not sit on the front-passenger seat.
- the front-passenger seat is occupied by an adult or a person of an appropriate size, the PASSENGER AIR BAG ON indicator lamp lights up continuously after the system's self-diagnosis test. This indicates that the front-passenger front air bag is activated.

If children are traveling in the vehicle, be sure to observe the notes on "Children in the vehicle" (▷ page 61).

If the OCS is malfunctioning, both the red  restraint system warning lamp in the instrument cluster and the PASSENGER AIR BAG OFF indicator lamp light up simultaneously. In this case, the front-passenger air bag is deactivated and does not deploy during an accident. Have the system checked by qualified technicians as soon as possible. Consult an authorized Mercedes-Benz Center. Only have the front-passenger seat repaired at an authorized Mercedes-Benz Center.

If the front-passenger seat, the seat cover or the seat cushion are damaged, have the necessary repair work carried out at an authorized Mercedes-Benz Center.

For safety reasons, Mercedes-Benz recommends that you only use seat accessories that have been approved by Mercedes-Benz.

If the driver's air bag deploys, this does not mean that the front-passenger front air bag will also deploy. The Occupant Classification System (OCS) categorizes the occupant on the front-passenger seat. Depending on the result, the front-passenger air bag is activated or deactivated.

### System self-test

#### DANGER

If both the PASSENGER AIR BAG OFF and PASSENGER AIR BAG ON indicator lamps do not light up during the system self-test, the system is malfunctioning. The front-passenger front air bag might be triggered unintentionally or might not be triggered at all in the event of an accident with high deceleration. This poses an increased risk of injury or even fatal injury.

In this case the front-passenger seat may not be used. Do not install a child restraint system on the front-passenger seat. Have the Occupant Classification System (OCS) checked and repaired immediately at a qualified specialist workshop.

#### DANGER

If the PASSENGER AIR BAG OFF indicator lamp remains lit after the system self-test, the front-passenger front air bag is disabled. It will not be deployed in the event of an accident. In this case, the front-passenger front air bag cannot perform its intended protective function, e.g. when a person is seated in the front-passenger seat.

That person could, for example, come into contact with the vehicle's interior, especially if the person is sitting too close to the dashboard. This poses an increased risk of injury or even fatal injury.

When the front-passenger seat is occupied, always ensure that:

- the classification of the person in the front-passenger seat is correct and the front-passenger front air bag is enabled or disabled in accordance with the person in the front-passenger seat
- the person is seated properly with a correctly fastened seatbelt
- the front-passenger seat has been moved back as far back as possible

If the PASSENGER AIR BAG OFF indicator lamp remains lit when it should not, the front-passenger seat may not be used. Do not install a child restraint system on the front-passenger seat. Have the Occupant Classification System (OCS) checked and repaired immediately at a qualified specialist workshop.

#### WARNING

Objects between the seat surface and the child restraint system could affect OCS operation. This could result in the front-passenger air bag not functioning as intended during an accident. This poses an increased risk of injury or even fatal injury.

Do not place any objects between the seat surface and the child restraint system. The entire base of the child restraint system must always rest on the seat cushion of the front-passenger seat. The backrest of the forward-facing child restraint system must, as far as possible, be resting on the backrest of the front-passenger seat. Always comply with the child restraint system manufacturer's installation instructions.

After the system self-test, the PASSENGER AIR BAG OFF or PASSENGER AIR BAG ON indicator lamp displays the status of the front-passenger front air bag (> page 54).

For more information about the OCS, see "Problems with the Occupant Classification System" (> page 57).

## Problems with the Occupant Classification System (OCS)

Be sure to observe the notes on "System self-test" (▷ page 56).

Problem	Possible causes/consequences and ► Solutions
<p>The PASSENGER AIR BAG OFF indicator lamp lights up and remains lit, even though the front-passenger seat is occupied by an adult or a person of a stature corresponding to that of an adult.</p>	<p>The classification of the person on the front-passenger seat is incorrect.</p> <ul style="list-style-type: none"> <li>► Make sure the conditions for a correct classification of the person on the front-passenger seat are met (▷ page 53).</li> <li>► If the PASSENGER AIR BAG OFF indicator lamp remains lit, the front-passenger seat may not be used.</li> <li>► Have OCS checked as soon as possible at an authorized Mercedes-Benz Center.</li> </ul>
<p>The PASSENGER AIR BAG OFF indicator lamp does not light up and/or does not stay on.</p> <p>The front-passenger seat is:</p> <ul style="list-style-type: none"> <li>• unoccupied</li> <li>• occupied with the weight of a child up to twelve months old in a child restraint system</li> </ul>	<p>OCS is malfunctioning.</p> <ul style="list-style-type: none"> <li>► Make sure there is nothing between the seat cushion and the child seat.</li> <li>► Make sure that the entire base of the child restraint system rests on the seat cushion of the front-passenger seat. The backrest of the forward-facing child restraint system must lie as flat as possible against the backrest of the front-passenger seat. If necessary, adjust the position of the front-passenger seat.</li> <li>► Make sure that the seat cushion length is fully retracted.</li> <li>► When installing the child restraint system, make sure that the seat belt is tight. Do not pull the seat belt tight using the front-passenger seat adjustment. This could result in the seat belt and the child restraint system being pulled too tightly.</li> <li>► Check for correct installation of the child restraint system. Make sure that the head restraint does not apply a load to the child restraint system. If necessary, adjust the head restraint accordingly.</li> <li>► Make sure that no objects are applying additional weight onto the seat.</li> <li>► If the PASSENGER AIR BAG OFF indicator lamp remains off and/or the PASSENGER AIR BAG ON indicator lamp lights up, do not install a child restraint system on the front-passenger seat. It is recommended that you install the child restraint system on a suitable rear seat.</li> <li>► Have OCS checked as soon as possible at an authorized Mercedes-Benz Center.</li> </ul>

### Deployment of Emergency Tensioning Devices and air bags

#### Important safety notes

##### WARNING

The air bag parts are hot after an air bag has been deployed. There is a risk of injury.

Do not touch the air bag parts. Have a deployed air bag replaced at a qualified specialist workshop as soon as possible.

##### WARNING

A deployed air bag no longer offers any protection and cannot provide the intended pro-

tection in an accident. There is an increased risk of injury.

Have the vehicle towed to a qualified specialist workshop in order to have a deployed air bag replaced.

It is important for your safety and that of your passenger to have deployed air bags replaced and to have any malfunctioning air bags repaired. This will help to make sure the air bags continue to perform their protective function for the vehicle occupants in the event of a crash.

### WARNING

Pyrotechnic Emergency Tensioning Devices that have been deployed are no longer operational and are unable to perform their intended protective function. This poses an increased risk of injury or even fatal injury.

Therefore, have pyrotechnic Emergency Tensioning Devices which have been triggered immediately replaced at a qualified specialist workshop.

An electric motor is used by PRE-SAFE® to trigger the tightening of the seat belt in hazardous situations. This procedure is reversible.

If Emergency Tensioning Devices are triggered or air bags are deployed, you will hear a bang, and a small amount of powder may also be released. The  restraint system warning lamp lights up.

Only in rare cases will the bang affect your hearing. The powder that is released generally does not constitute a health hazard, but it may cause short-term breathing difficulties in people with asthma or other respiratory problems. Provided it is safe to do so, you should leave the vehicle immediately or open the window in order to prevent breathing difficulties.

Air bags and pyrotechnic Emergency Tensioning Devices (ETDs) contain perchlorate material, which may require special handling and regard for the environment. National guidelines must be observed during disposal. In California, see [www.dtsc.ca.gov/HazardousWaste/Perchlorate/index.cfm](http://www.dtsc.ca.gov/HazardousWaste/Perchlorate/index.cfm).

## Method of operation

During the first stage of a collision, the restraint system control unit evaluates important physical data relating to vehicle deceleration or acceleration, such as:

- duration
- direction
- intensity

Based on the evaluation of this data, the restraint system control unit triggers the Emergency Tensioning Devices during a frontal or rear collision.

An Emergency Tensioning Device can only be triggered, if:

- the ignition is switched on
- the components of the restraint system are operational. You can find further information under: "Restraint system warning lamp" (▷ page 45)
- the belt tongue is engaged in the buckle on the respective front-passenger seat

The Emergency Tensioning Devices in the rear compartment are triggered independently of the lock status of the seat belts.

**Vehicles with belt bags:** the belt bags are also deployed depending on the type and severity of the accident.

**Vehicles with a rear reclining seat:** the Emergency Tensioning Device is only triggered if the belt buckle tongue is engaged in the belt buckle.

If the seat backrest is reclined, the cushion air bag will also be deployed depending on the type and severity of the accident.

If the restraint system control unit detects a more severe accident, further components of the restraint system are activated independently of each other in certain frontal collision situations:

- Front air bags and driver's knee bag
- Window curtain air bag, if the system determines that deployment can offer additional protection to that provided by the seat belt

The front-passenger front air bag is activated or deactivated depending on the person on the front-passenger seat. The front-passenger front air bag can only deploy in an accident if the PASSENGER AIR BAG ON indicator lamp is lit. Observe the information on the PASSENGER AIR BAG indicator lamps (▷ page 46).

Your vehicle has two-stage front air bags. During the first deployment stage, the front air bag is filled with propellant gas to reduce the risk of injuries. The front air bag is fully deployed with the maximum amount of propellant gas if a second deployment threshold is reached within a few milliseconds.

The activation threshold of the Emergency Tensioning Devices and the air bag are determined by evaluating the rate of vehicle deceleration or acceleration which occurs at various points in the vehicle. This process is pre-emptive in nature. Deployment should take place in good time at the start of the collision.

The rate of vehicle deceleration or acceleration and the direction of the force are essentially determined by:

- the distribution of forces during the collision
- the collision angle
- the deformation characteristics of the vehicle
- the characteristics of the object with which the vehicle has collided

Factors which can only be seen and measured after a collision has occurred do not play a decisive role in the deployment of an air bag. Nor do they provide an indication of air bag deployment.

The vehicle can be deformed considerably, without an air bag being deployed. This is the case if only parts which are relatively easily deformed are affected and the rate of deceleration is not high. Conversely, air bags may be deployed even though the vehicle suffers only minor deformation. This is the case if, for example, very rigid vehicle parts such as longitudinal body members are hit, and sufficient deceleration occurs as a result.

If the control unit of the restraint system detects a side impact or a vehicle rollover, the relevant components of the restraint system are activated separately depending on the anticipated type of accident.

- Side impact air bags on the side where the impact takes place, independently of the Emergency Tensioning Device and the use of the seat belt on the driver's seat and outer seats in the second row

The side impact air bag on the front-passenger side (front) deploys under the following conditions:

- the OCS system detects that the front-passenger seat is occupied or
- the belt tongue is engaged in the belt buckle of the front-passenger seat
- Window curtain air bag on the side of impact, independently of the use of the seat belt and independently of whether the front-passenger seat is occupied
- Emergency Tensioning Devices, if the system determines that deployment can offer additional protection in this situation
- Window curtain air bags on the driver's and front-passenger side in certain situations when the vehicle rolls over, if the system determines that deployment can offer additional protection to that provided by the seat belt

**i** Not all air bags are deployed in an accident. The different air bag systems work independently of each other.

How the air bag system works is determined by the severity of the accident detected, especially the vehicle deceleration or acceleration and the apparent type of accident:

- Frontal collision
- Side impact
- Rollover

## PRE-SAFE® (anticipatory occupant protection system)

### Introduction

In certain hazardous situations, PRE-SAFE® takes pre-emptive measures to protect the vehicle occupants.

### Important safety notes

**!** Make sure that there are no objects in the footwell or behind the seats. There is a danger that the seats and/or objects could be damaged when PRE-SAFE® is activated.

Despite your vehicle being equipped with the PRE-SAFE® system, the possibility of personal injuries occurring as a result of an accident cannot be eliminated. Always adapt your driving

style to suit the prevailing road and weather conditions and maintain a safe distance from the vehicle in front. Drive carefully.

## Function

PRE-SAFE® intervenes:

- in emergency braking situations, e.g. when BAS is activated
- in critical driving situations, e.g. when physical limits are exceeded and the vehicle understeers or oversteers severely
- vehicles with the Driving Assistance package: when a driver assistance system intervenes powerfully or the radar sensor system detects an imminent danger of collision in certain situations

PRE-SAFE® takes the following measures depending on the hazardous situation detected:

- the front seat belts are pre-tensioned.
- if the vehicle skids, the side windows and the panorama roof with power tilt/sliding panel are closed.
- the front-passenger seat is adjusted if it is in an unfavorable position.
- for vehicles with electrically adjustable rear seats: the outer rear seats are adjusted if they are in an unfavorable position.
- vehicles with a multicontour seat: the air pressure in the side bolsters of the seat backrest is increased.
- vehicles with seat belt extenders: the seat belts of the outer rear seats are pre-tensioned.

If the hazardous situation passes without resulting in an accident, PRE-SAFE® slackens the belt pre-tensioning. On vehicles with multicontour seats, the air pressure in the side bolsters is reduced again. All settings made by PRE-SAFE® can then be reversed.

If the seat belt pre-tensioning is not reduced:

- ▶ Move the seat backrest or seat back slightly when the vehicle is stationary.  
The seat belt pre-tensioning is reduced and the locking mechanism is released.

The seat-belt adjustment is an integral part of the PRE-SAFE® convenience function. Information about the convenience function can be found under "Belt adjustment" (▷ page 50).

## PRE-SAFE® PLUS (anticipatory occupant protection system PLUS)

### Introduction

PRE-SAFE® PLUS is only available in vehicles with the Driving Assistance package.

Using the radar sensor system, PRE-SAFE® PLUS is able to detect that a head-on or rear-end collision is imminent. In certain hazardous situations, PRE-SAFE® PLUS takes pre-emptive measures to protect the vehicle occupants.

### Important safety notes

The intervention of PRE-SAFE® PLUS cannot prevent an imminent collision.

The driver is not warned when PRE-SAFE® PLUS intervenes.

PRE-SAFE® PLUS does not intervene if the vehicle is backing up.

When driving, or when parking or exiting a parking space with assistance from Active Parking Assist, PRE-SAFE® PLUS will not apply the brakes.

### Function

PRE-SAFE® PLUS intervenes in certain situations if the radar sensor system detects an imminent head-on or rear-end collision.

PRE-SAFE® PLUS takes the following measures depending on the hazardous situation detected:

- if the radar sensor system detects that a head-on collision is imminent, the seat belts are pre-tensioned.
- if the radar sensor system detects that a rear-end collision is imminent:
  - the brake pressure is increased if the driver applies the brakes when the vehicle is stationary.
  - the seat belts are pre-tensioned.

The PRE-SAFE® PLUS braking application is canceled:

- if the accelerator pedal is depressed when a gear is engaged
- if the risk of a collision passes or is no longer detected
- if DISTRONIC PLUS indicates an intention to pull away

If the hazardous situation passes without resulting in an accident, the original settings are restored.

### Automatic measures after an accident

Immediately after an accident, the following measures are implemented, depending on the type and severity of the impact:

- the hazard warning lamps are activated
- the emergency lighting is activated
- the vehicle doors are unlocked
- the front side windows are lowered
- the electrically adjustable steering wheel is raised
- the engine is switched off and the fuel supply is cut off
- vehicles with seat belt extenders: the seat-belt buckles for the outer rear seats are illuminated and extend forwards
- vehicles with mbrace: automatic emergency call
- vehicles with the hybrid drive system: the hybrid system and the high-voltage electrical system are deactivated

## Children in the vehicle

### Important safety notes

Accident statistics show that children secured in the rear seats are safer than children secured in the front-passenger seat. For this reason, Mercedes-Benz strongly advises that you install a child restraint system on a rear seat. Children are generally better protected there.

If a child younger than twelve years old and under 5 ft (1.50 m) in height is traveling in the vehicle:

- always secure the child in a child restraint system suitable for Mercedes-Benz vehicles. The child restraint system must be appropriate to the age, weight and size of the child
- be sure to observe the instructions and safety notes in this section in addition to the child

restraint system manufacturer's installation instructions

- be sure to observe the instructions and safety notes on the "Occupant classification system (OCS)" (▷ page 53)

### WARNING

If you leave children unsupervised in the vehicle, they could set it in motion by, for example:

- release the parking brake.
- shift the automatic transmission out of the parking position **P**.
- start the engine.

In addition, they may operate vehicle equipment and become trapped. There is a risk of an accident and injury.

When leaving the vehicle, always take the SmartKey with you and lock the vehicle. Never leave children unsupervised in the vehicle.

### WARNING

If persons, particularly children are subjected to prolonged exposure to extreme heat or cold, there is a risk of injury, possibly even fatal. Never leave children unattended in the vehicle.

### WARNING

If the child restraint system is subjected to direct sunlight, parts may get very hot. Children may burn themselves on these parts, particularly on the metal parts of the child restraint system. There is a risk of injury.

If you leave the vehicle, taking the child with you, always ensure that the child restraint system is not exposed to direct sunlight. Protect it with a blanket, for example. If the child restraint system has been exposed to direct sunlight, let it cool down before securing the child in it. Never leave children unattended in the vehicle.

Always ensure that all vehicle occupants have their seat belts fastened correctly and are sitting properly. Particular attention must be paid to children.

Observe the safety notes on the seat belt (> page 47) and the notes on correct use of seat belts (> page 48).

A booster seat may be necessary to achieve proper seat belt positioning for children over 41 lbs (18 kg) until they reach a height where a three-point seat belt can be properly fastened without a booster seat.

### Special seat belt retractor

#### WARNING

If the seat belt is released while driving, the child restraint system will no longer be secured properly. The special seat belt retractor is disabled and the inertia reel draws in a portion of the seat belt. The seat belt cannot be immediately refastened. There is an increased risk of injury, possibly even fatal.

Stop the vehicle immediately, paying attention to road and traffic conditions. Reactivate the special seat belt retractor and secure the child restraint system properly.

All seat belts except the driver's seat belt are equipped with a special seat belt retractor. When activated, the special seat belt retractor ensures that the seat belt will not slacken once the child restraint system has been secured.

Installing a child restraint system:

- ▶ Always comply with the child restraint system manufacturer's installation instructions.
- ▶ Pull the seat belt smoothly from the belt outlet.
- ▶ Engage the seat belt tongue in the belt buckle.

Activating the special seat belt retractor:

- ▶ Pull the seat belt out fully and let the inertia reel retract it again.  
While the seat belt is retracting, you should hear a ratcheting sound. The special seat belt retractor is activated.
- ▶ Push the child seat restraint system down so that the seat belt is tight and does not loosen.

Removing a child restraint system and deactivating the special seat belt retractor:

- ▶ Always comply with the child restraint system manufacturer's installation instructions.
- ▶ Press the release button of the belt buckle, hold the belt tongue firmly and guide it back towards the belt outlet.  
The special seat belt retractor is deactivated.

### Child restraint system

The use of seat belts and child restraint systems is required by law in:

- all 50 states
- the U.S. territories
- the District of Columbia
- all Canadian provinces

You can obtain further information about the correct child restraint system from any authorized Mercedes-Benz Center.

#### WARNING

If the child restraint system is installed incorrectly on a suitable seat, it cannot protect as intended. The child cannot then be restrained in the event of an accident, heavy braking or sudden changes of direction. There is an increased risk of injury, possibly even fatal.

Make sure that you observe the child restraint system manufacturer's installation instructions and the notes on use. Please ensure, that the base of the child restraint system is always resting completely on the seat cushion. Never place objects, e.g. cushions, under or behind the child restraint system. Only use child restraint systems with the original cover designed for them. Only replace damaged covers with genuine covers.

#### WARNING

If the child restraint system is installed incorrectly or is not secured, it can come loose in the event of an accident, heavy braking or a sudden change in direction. The child restraint system could be thrown about, striking vehicle occupants. There is an increased risk of injury, possibly even fatal.



Always install child restraint systems properly, even if they are not being used. Make sure that you observe the child restraint system manufacturer's installation instructions.

You will find further information on stowing objects, luggage or loads under "Loading guidelines" (▷ page 325).

### WARNING

Child restraint systems or their securing systems which have been damaged or subjected to a load in an accident can no longer protect as intended. The child cannot then be restrained in the event of an accident, heavy braking or sudden changes of direction. There is an increased risk of injury, possibly even fatal.

Replace child restraint systems which have been damaged or subjected to a load in an accident as soon as possible. Have the securing systems on the child restraint system checked at a qualified specialist workshop, before you install a child restraint system again.

The securing systems of child restraint systems are:

- the seat belt system
- the LATCH-type (ISOFIX) securing rings
- the Top Tether anchorages

If it is absolutely necessary to carry a child on the front-passenger seat, be sure to observe the information on the "Occupant Classification System (OCS)" (▷ page 53). There you will also find information on deactivating the front-passenger front air bag.

All child restraint systems must meet the following standards:

- U.S. Federal Motor Vehicle Safety Standards 213 and 225
- Canadian Motor Vehicle Safety Standards 213 and 210.2

Confirmation that the child restraint system corresponds to the standards can be found on an instruction label on the child restraint system. This confirmation can also be found in the installation instructions that are included with the child restraint system.

Observe the warning labels in the vehicle interior and on the child restraint system.

**Vehicles with seat belt extenders:** when securing a child in a child restraint system on a rear seat, observe the following instructions:

- make sure that the seat belt on the child restraint system is fastened according to the manufacturer's installation instructions for the child restraint system.
- for child restraint systems with a belt clamp: engage the belt tongue in the buckle before you tighten the seat belt using the belt clamp.

**Vehicles with a rear reclining seat:** when installing a child restraint system, move the rear reclining seat backrest to an almost vertical position. The rear reclining seat backrest must rest against the child restraint system. Observe the notes on the cushion air bag (▷ page 53).

**Vehicles with belt bags:** only use a child restraint system which has been approved by Mercedes-Benz. Always observe the instructions and safety notes on belt bags for the outer seat belts in the rear (▷ page 48).

### LATCH-type (ISOFIX) child seat securing system

#### WARNING

LATCH-type (ISOFIX) child restraint systems do not offer sufficient protective effect for children whose weight is greater than 48 lbs (22 kg) who are secured using the safety belt integrated in the child restraint system. In the event of an accident, a child might not be restrained correctly. This poses an increased risk of injury or even fatal injury.

If the child weighs more than 48 lbs (22 kg), only use LATCH-type (ISOFIX) child restraint systems with which the child is also secured with the vehicle seat belt. Also secure the child restraint system with the Top Tether belt, if available.

Always comply with the manufacturer's installation and operating instructions for the child restraint system used.

Before every trip, make sure that the LATCH-type (ISOFIX) child restraint system is engaged correctly in both LATCH-type (ISOFIX) securing rings

**!** When installing the child restraint system, make sure that the seat belt for the middle seat does not get trapped. The seat belt could otherwise be damaged.

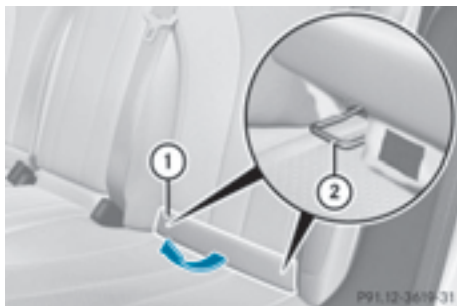

LATCH-type (ISOFIX) securing rings (2) on the rear seats are covered by a Velcro-fastened upholstered lining (1).

- ▶ **Vehicles with a rear reclining seat:** adjust the rear reclining seat backrest down a little before installing the LATCH-type (ISOFIX) child restraint system.
- ▶ **Vehicles without rear reclining seat:** fold upholstered lining (1) upwards.
- ▶ **Vehicles with a rear reclining seat:** remove upholstered lining (1).
- ▶ **Vehicles without a rear reclining seat:** turn the support on the rear side of upholstered lining (1) by 90°. Upholstered lining (1) remains folded upwards.
- ▶ Install the LATCH-type (ISOFIX) child restraint system on both LATCH-type (ISOFIX) securing rings (2).
- ▶ **Vehicles with a rear reclining seat:** move the rear reclining seat backrest to an upright position. The rear reclining seat backrest must rest against the child restraint system.

#### **⚠ WARNING**

Vehicles with electrically adjustable rear bench seats:

If you adjust the seat after installing a child restraint system:

- the seat belt could slacken or become too tight
- the child restraint system could become loose, incorrectly positioned or damaged

As a result, the child restraint system may not be able to provide the intended level of protection. This poses an increased risk of injury or even fatal injury.

Never adjust the seat after installing the child restraint system.

**Vehicles without rear reclining seat:** after you have removed the LATCH-type (ISOFIX) child restraint system, you must turn the support on the rear side of upholstered lining (1) by 90° again. Then fold upholstery lining (1) down. ISOFIX is a standardized securing system for specially designed child restraint systems on the rear seats. LATCH-type (ISOFIX) securing rings (2) for two LATCH-type (ISOFIX) child restraint systems are installed on the left and right rear seats.

**Vehicles with rear seat armrest:** adjust the rear seat armrest so that LATCH-type (ISOFIX) securing rings (2) for the LATCH-type (ISOFIX) child restraint system are accessible.

Non-LATCH-type (ISOFIX) child seats may also be used and can be installed using the vehicle's seat belt system. Install the child seat according to the manufacturer's instructions.

## Top Tether

### Introduction

Top Tether provides an additional connection between the child restraint system secured with a LATCH-type (ISOFIX) system and the vehicle. This helps reduce the risk of injury even further. If the child restraint system is equipped with a Top Tether belt, this should always be used.

### Important safety notes

#### **⚠ WARNING**

If the rear seat backrests are not locked, they could fold forwards in the event of an accident, heavy braking or sudden changes of direction. As a result, child restraint systems cannot perform their intended protective function. Rear seat backrests that are not locked can also cause additional injuries, e.g. in the event of an accident. This poses an increased risk of injury or even fatal injury.

Always lock rear seat backrests after installing a Top Tether belt. Observe the lock verification indicator. Adjust the rear seat backrests so that they are in an upright position.

### WARNING

Vehicles with electrically adjustable rear bench seats:

If you adjust the seat after installing a child restraint system:

- the seat belt could slacken or become too tight
- the child restraint system could become loose, incorrectly positioned or damaged

As a result, the child restraint system may not be able to provide the intended level of protection. This poses an increased risk of injury or even fatal injury.

Never adjust the seat after installing the child restraint system.

If the rear seat backrest is not engaged and locked, this will be shown in the multifunction display in the instrument cluster. A warning tone also sounds.

## Top Tether anchorages

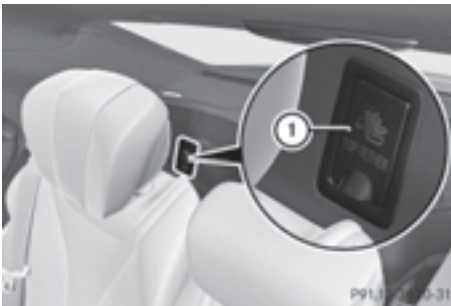

The Top Tether anchorage points are installed in the rear compartment behind the head restraints on the parcel shelf.

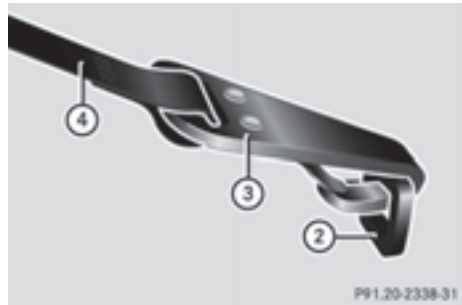

- ▶ Move the head restraint up (▷ page 116).
- ▶ Fold up cover ① of the Top Tether anchorage.
- ▶ Install the LATCH-type (ISOFIX) child restraint system with Top Tether. Always comply with the child restraint system manufacturer's installation instructions when doing so.
- ▶ Route Top Tether belt ④ under the head restraint between the two head restraint bars.
- ▶ Hook Top Tether hook ③ of Top Tether belt ④ into Top Tether anchorage ②. Make sure that Top Tether belt ④ is not twisted.
- ▶ Tension Top Tether belt ④. Always comply with the child restraint system manufacturer's installation instructions when doing so.
- ▶ Fold down cover ① of the Top Tether anchorage.
- ▶ If necessary, move the head restraint back down again slightly (▷ page 116). Make sure that you do not interfere with the correct routing of Top Tether belt ④.

## Child restraint system on the front-passenger seat

### General notes

Accident statistics show that children secured in the rear seats are safer than children secured in the front-passenger seat. For this reason, Mercedes-Benz strongly advises that you install the child restraint system on a rear seat.

If it is absolutely necessary to install a child restraint system on the front-passenger seat, always observe the instructions and safety notes on the "Occupant Classification System (OCS)" (▷ page 53).

You can thus avoid the risks that could arise as a result of:

- an incorrectly categorized person in the front-passenger seat
- the unintentional deactivation of the front-passenger front air bag
- the unsuitable positioning of the child restraint system, e.g. too close to the dashboard

### Rearward-facing child restraint system

If it is absolutely necessary to install a rearward-facing child restraint system on the front-passenger seat, always make sure that the front-passenger front air bag is deactivated. Only if the PASSENGER AIR BAG OFF indicator lamp is permanently lit (> page 46) is the front-passenger front air bag deactivated.

Always observe the child restraint system manufacturer's installation and operating instructions.

### Forward-facing child restraint system

If it is absolutely necessary to install a forward-facing child restraint system on the front-passenger seat, always move the front-passenger seat as far back as possible. Fully retract the seat cushion length. The entire base of the child restraint system must always rest on the seat cushion of the front-passenger seat. The backrest of the child restraint system must lie as flat as possible against the backrest of the front-passenger seat. The child restraint system must not touch the roof or be subjected to a load by the head restraint. Adjust the angle of the seat backrest and the head restraint position accordingly. Always make sure that the shoulder belt strap is correctly routed from the vehicle belt outlet to the shoulder belt guide on the child restraint system. The shoulder belt strap must be routed forwards and downwards from the vehicle belt outlet. If necessary, adjust the vehicle belt outlet and the front-passenger seat accordingly.

Always observe the child restraint system manufacturer's installation and operating instructions.

## Child-proof locks

### Important safety notes

#### WARNING

If children are traveling in the vehicle, they could:

- open doors, thus endangering other people or road users
- exit the vehicle and be caught by oncoming traffic
- operate vehicle equipment and become trapped

There is a risk of an accident and injury.

Always activate the child-proof locks and override feature if children are traveling in the vehicle. When leaving the vehicle, always take the key with you and lock the vehicle. Never leave children unattended in the vehicle.

Override feature for:

- the rear doors (> page 67)
- the rear side windows (> page 67)

#### WARNING

If you leave children unsupervised in the vehicle, they could set it in motion by, for example:

- release the parking brake.
- shift the automatic transmission out of the parking position **P**.
- start the engine.

In addition, they may operate vehicle equipment and become trapped. There is a risk of an accident and injury.

When leaving the vehicle, always take the SmartKey with you and lock the vehicle. Never leave children unsupervised in the vehicle.

#### WARNING

If persons, particularly children are subjected to prolonged exposure to extreme heat or cold, there is a risk of injury, possibly even fatal. Never leave children unattended in the vehicle.

**⚠ WARNING**

If the child restraint system is subjected to direct sunlight, parts may get very hot. Children may burn themselves on these parts, particularly on the metal parts of the child restraint system. There is a risk of injury.

If you leave the vehicle, taking the child with you, always ensure that the child restraint system is not exposed to direct sunlight. Protect it with a blanket, for example. If the child restraint system has been exposed to direct sunlight, let it cool down before securing the child in it. Never leave children unattended in the vehicle.

**Child-proof locks for the rear doors**

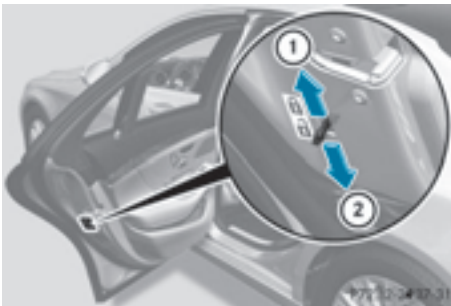

You secure each door individually with the child-proof locks on the rear doors. A door secured with a child-proof lock cannot be opened from inside the vehicle. When the vehicle is unlocked, the door can be opened from the outside.

- ▶ **To activate:** press the child-proof lock lever up in the direction of arrow ①.
- ▶ Make sure that the child-proof locks are working properly.
- ▶ **To deactivate:** press the child-proof lock lever down in the direction of arrow ②.

**Override feature for the rear side windows**



- ▶ **To activate/deactivate:** press button ②. If indicator lamp ① is lit, operation of the rear side windows is disabled. Operation is only possible using the switches in the driver's door. If indicator lamp ① is off, operation is possible using the switches in the rear compartment.

When the override feature is activated, the controls in the rear compartment are disabled for:

- the rear side windows
- adjustment of the front-passenger seat from the rear compartment
- the sunblinds:
  - of the rear side windows
  - of the rear window
  - in the roof

**Pets in the vehicle**

**⚠ WARNING**

If you leave animals unattended or unsecured in the vehicle, they could press buttons or switches, for example.

As a result, they could:

- activate vehicle equipment and become trapped, for example
- activate or deactivate systems, thereby endangering other road users

Unsecured animals could also be flung around the vehicle in the event of an accident or sudden steering or braking, thereby injuring vehi-

cle occupants. There is a risk of an accident and injury.

Never leave animals unattended in the vehicle. Always secure animals properly during the journey, e.g. use a suitable animal transport box.

## Driving safety systems

### Overview of driving safety systems

In this section, you will find information about the following driving safety systems:

- **ABS (Anti-lock Braking System)** (▷ page 68)
- **BAS (Brake Assist System)** (▷ page 69)
- **BAS PLUS (Brake Assist System PLUS)** with Cross-Traffic Assist (▷ page 69)
- **COLLISION PREVENTION ASSIST PLUS** (▷ page 71)
- **ESP® (Electronic Stability Program)** (▷ page 73)
- **EBD (Electronic Brake force Distribution)** (▷ page 75)
- **ADAPTIVE BRAKE** (▷ page 75)
- **PRE-SAFE® Brake** (▷ page 75)
- **STEER CONTROL** (▷ page 77)

### Important safety notes

If you fail to adapt your driving style or if you are inattentive, the driving safety systems can neither reduce the risk of an accident nor override the laws of physics. Driving safety systems are merely aids designed to assist driving. You are responsible for maintaining the distance to the vehicle in front, for vehicle speed, for braking in good time, and for staying in lane. Always adapt your driving style to suit the prevailing road and weather conditions and maintain a safe distance from the vehicle in front. Drive carefully.

The driving safety systems described only work as effectively as possible when there is adequate contact between the tires and the road surface. Pay particular attention to the information regarding tires, recommended minimum tire tread depths etc. in the "Wheels and tires" section (▷ page 384).

In wintry driving conditions, always use winter tires (M+S tires) and if necessary, snow chains. Only in this way will the driving safety systems described in this section work as effectively as possible.

## ABS (Anti-lock Braking System)

### General information

ABS regulates brake pressure in such a way that the wheels do not lock when you brake. This allows you to continue steering the vehicle when braking.

The  ABS warning lamp in the instrument cluster lights up when the ignition is switched on. It goes out when the engine is running.

ABS works from a speed of about 5 mph (8 km/h), regardless of road-surface conditions. ABS works on slippery surfaces, even when you only brake gently.

### Important safety notes

 Observe the "Important safety notes" section (▷ page 68).

#### **WARNING**

If ABS is faulty, the wheels could lock when braking. The steerability and braking characteristics may be severely impaired. Additionally, further driving safety systems are deactivated. There is an increased danger of skidding and accidents.

Drive on carefully. Have ABS checked immediately at a qualified specialist workshop.

When ABS is malfunctioning, other systems, including driving safety systems, will also become inoperative. Observe the information on the ABS warning lamp (▷ page 316) and display messages which may be shown in the instrument cluster (▷ page 278).

### Braking

- ▶ **If ABS intervenes:** continue to depress the brake pedal vigorously until the braking situation is over.
- ▶ **To make a full brake application:** depress the brake pedal with full force.

If ABS intervenes when braking, you will feel a pulsing in the brake pedal.

The pulsating brake pedal can be an indication of hazardous road conditions, and functions as a reminder to take extra care while driving.

## BAS (Brake Assist System)

### General information

BAS operates in emergency braking situations. If you depress the brake pedal quickly, BAS automatically boosts the braking force, thus shortening the stopping distance.

### Important safety notes

- Observe the "Important safety notes" section (▷ page 68).

#### WARNING

If BAS is malfunctioning, the braking distance in an emergency braking situation is increased. There is a risk of an accident.

In an emergency braking situation, depress the brake pedal with full force. ABS prevents the wheels from locking.

### Braking

- Keep the brake pedal firmly depressed until the emergency braking situation is over. ABS prevents the wheels from locking.

The brakes will function as usual once you release the brake pedal. BAS is deactivated.

## BAS PLUS (Brake Assist System PLUS) with Cross-Traffic Assist

### General information

BAS PLUS can help you to minimize the risk of a collision with a vehicle or a pedestrian and reduce the effects of such a collision. If BAS PLUS detects a danger of collision, you are assisted when braking.

- Pay attention to the important safety notes in the "Driving safety systems" section (▷ page 68).

BAS PLUS is only available in vehicles with the Driving Assistance Plus package.

For BAS PLUS to assist you when driving, the radar sensor system and the camera system must be operational.

With the help of a sensor system and a camera system, BAS PLUS can detect obstacles:

- that are in the path of your vehicle for an extended period of time
- that cross the path of your vehicle

In addition, pedestrians in the path of your vehicle can be detected.

BAS PLUS detects pedestrians by using typical characteristics such as the body contours and posture of a person standing upright.

If the radar sensor system or the camera system is malfunctioning, BAS PLUS functions are restricted or no longer available. The brake system is still available with complete brake boosting effect and BAS.

- Observe the restrictions described in the "Important safety notes" section (▷ page 69).

### Important safety notes

#### WARNING

BAS PLUS cannot always clearly identify objects and complex traffic situations.

In such cases, BAS PLUS may:

- intervene unnecessarily
- not intervene

There is a risk of an accident.

Always pay careful attention to the traffic situation and be ready to brake. Terminate the intervention in a non-critical driving situation.

#### WARNING

BAS PLUS cannot always clearly identify people, this is especially the case if they are moving. BAS PLUS cannot intervene in these cases. There is a risk of an accident.

Always pay careful attention to the traffic situation and be ready to brake.

 **WARNING**

BAS PLUS does not react:

- to small people, e.g. children
- to animals
- to oncoming vehicles
- when cornering

As a result, BAS PLUS may not intervene in all critical situations. There is a risk of an accident.

Always pay careful attention to the traffic situation and be ready to brake.

In the event of snowfall or heavy rain, the recognition can be impaired.

Recognition by the radar sensor system is also impaired in the event of:

- there is dirt on the sensors or anything else covering the sensors
- there is interference by other radar sources
- there are strong radar reflections, for example in parking garages
- a narrow vehicle traveling in front, e.g. a motorbike
- a vehicle traveling in front on a different line
- vehicles quickly moving into the radar sensor system detection range

Recognition by the camera system is also impaired in the event of:

- dirt on the camera or if the camera is covered
- there is glare on the camera system, e.g. from the sun being low in the sky
- darkness
- if:
  - pedestrians move quickly, e.g. into the path of the vehicle
  - the camera system no longer recognizes a pedestrian as a person due to special clothing or other objects
  - a pedestrian is concealed by other objects
  - the typical outline of a person is not distinguishable from the background

Following damage to the front end of the vehicle, have the configuration and operation of the radar sensors checked at a qualified specialist workshop. This also applies to collisions at slow speeds where there is no visible damage to the front of the vehicle.

Following damage to the windshield, have the configuration and operation of the camera system checked at a qualified specialist workshop.

**Function**

To avoid a collision, BAS PLUS calculates the brake force necessary if:

- you approach an obstacle, and
- BAS PLUS has detected a risk of collision

**When driving at a speed under 20 mph**

**(30 km/h):** if you depress the brake pedal, BAS PLUS is activated. The increase in brake pressure will be carried out at the last possible moment.

**When driving at a speed above 20 mph**

**(30 km/h):** if you depress the brake pedal sharply, BAS PLUS automatically raises the brake pressure to a value adapted to the traffic situation.

BAS PLUS provides braking assistance in hazardous situations with vehicles in front within a speed range between 4 mph (7 km/h) and 155 mph (250 km/h).

At speeds of up to approximately 44 mph (70 km/h), BAS PLUS can react to:

- stationary objects in the path of your vehicle, e.g. stopped or parked vehicles
- pedestrians in the path of your vehicle
- obstacles crossing your path, which move in the detection range of the sensors and are recognized by them

**i** If BAS PLUS demands particularly high braking force, preventative passenger protection measures (PRE-SAFE®) are activated simultaneously (▷ page 59).

- ▶ Keep the brake pedal depressed until the emergency braking situation is over. ABS prevents the wheels from locking.

BAS PLUS is deactivated and the brakes function as usual again, if:

- you release the brake pedal.
- there is no longer a risk of collision.
- no obstacle is detected in front of your vehicle.
- you depress the accelerator pedal.
- you activate kickdown.



## COLLISION PREVENTION ASSIST PLUS

### General information

COLLISION PREVENTION ASSIST PLUS consists of a distance warning function with an autonomous braking function and adaptive Brake Assist.

COLLISION PREVENTION ASSIST PLUS can help you to minimize the risk of a front-end collision with a vehicle ahead or reduce the effects of such a collision.

If COLLISION PREVENTION ASSIST PLUS detects that there is a risk of a collision, you will be warned visually and acoustically. If you do not react to the visual and audible collision warning, autonomous braking can be initiated in critical situations. If you apply the brake yourself in a critical situation, the COLLISION PREVENTION ASSIST PLUS adaptive Brake Assist assists you.

### Important safety notes

In particular, the detection of obstacles can be impaired if:

- there is dirt on the sensors or anything else covering the sensors
- there is snow or heavy rain
- there is interference by other radar sources
- there are strong radar reflections, for example in parking garages
- a narrow vehicle traveling in front, e.g. a motorbike
- a vehicle traveling in front on a different line
- new vehicles or after a service on the COLLISION PREVENTION ASSIST PLUS system

Observe the notes in the section on breaking-in (▷ page 161).

Following damage to the front end of the vehicle, have the configuration and operation of the radar sensor checked at a qualified specialist workshop. This also applies to collisions at slow speeds where there is no visible damage to the front of the vehicle.

### Switching on/off

The COLLISION PREVENTION ASSIST PLUS is automatically active after switching on the ignition.

You can activate or deactivate COLLISION PREVENTION ASSIST PLUS in the on-board computer (▷ page 270). When deactivated, the distance warning function and the autonomous braking function are also deactivated.

If COLLISION PREVENTION ASSIST PLUS is deactivated, the  symbol appears in the assistance graphics display.

### Distance warning function

#### General information

**i** Observe the "Important safety notes" section for driving safety systems (▷ page 68).

The distance warning function can help you to minimize the risk of a front-end collision with a vehicle ahead or reduce the effects of such a collision.

With the help of the radar sensor system, the distance warning function can detect obstacles that are in the path of your vehicle for an extended period of time.

If the distance warning function detects that there is a risk of a collision, you will be warned visually and acoustically.

Starting at a speed of approximately 4 mph (7 km/h), the distance warning function warns you if you rapidly approach a vehicle in front. An intermittent warning tone will then sound, and the  distance warning lamp will light up in the instrument cluster.

Up to a speed of approximately 44 mph (70 km/h), the distance warning function can also react to stationary obstacles, such as stopped or parked vehicles.

#### Important safety notes

##### WARNING

The distance warning function does not react:

- to people or animals
- to oncoming vehicles
- to crossing traffic
- when cornering

Thus, the distance warning function cannot provide a warning in all critical situations.

There is a risk of an accident.

Always pay careful attention to the traffic situation and be ready to brake.

**⚠ WARNING**

The distance warning function cannot always clearly identify objects and complex traffic situations.

In such cases, the distance warning function may:

- give an unnecessary warning
- not give a warning

There is a risk of an accident.

Always pay careful attention to the traffic situation and do not rely solely on the distance warning function.

- ▶ Brake immediately in order to increase the distance from the vehicle in front.
- or
- ▶ Take evasive action, provided it is safe to do so.

Due to the nature of the system, particularly complicated but non-critical driving conditions may also cause the system to display a warning.

**Autonomous braking function**

If the driver does not react to the distance warning signal in a critical situation, COLLISION PREVENTION ASSIST PLUS can assist with the autonomous braking function.

The autonomous braking function:

- gives the driver more time to react to critical driving situations
- can help the driver to avoid an accident or
- reduces the effects of an accident

The autonomous braking function is available in the following speed ranges:

- from 4 mph (7 km/h) to approx. 65 mph (105 km/h) for moving objects
- from 4 mph (7 km/h) to approx. 31 mph (50 km/h) for stationary objects

Due to the nature of the system, particularly complicated but non-critical driving conditions may also cause the Autonomous Braking Function to intervene.

If the autonomous braking function requires a particularly high braking force, preventative passenger protection measures (PRE-SAFE®) are activated simultaneously (▷ page 59).

**Adaptive Brake Assist****General information**

- ⓘ Observe the "Important safety notes" section (▷ page 68).

With the help of adaptive Brake Assist, the distance warning signal can detect obstacles that are in the path of your vehicle for an extended period of time.

If adaptive Brake Assist detects a risk of collision with the vehicle in front, it calculates the braking force necessary to avoid a collision. If you apply the brakes forcefully, adaptive Brake Assist will automatically increase the braking force to a level suitable for the traffic conditions.

Adaptive Brake Assist provides braking assistance in hazardous situations at speeds above 4 mph (7 km/h). It uses radar sensor technology to assess the traffic situation.

Up to a speed of approximately 155 mph (250 km/h), Adaptive Brake Assist is capable of reacting to moving objects that have already been detected as such at least once over the period of observation.

Up to a speed of approximately 44 mph (70 km/h), Adaptive Brake Assist reacts to stationary obstacles.

If adaptive Brake Assist demands particularly high braking force, preventative passenger protection measures (PRE-SAFE®) are activated simultaneously (▷ page 59).

- ▶ Keep the brake pedal depressed until the emergency braking situation is over. ABS prevents the wheels from locking.

The brakes will work normally again if:

- you release the brake pedal.
- there is no longer any danger of a collision.
- no obstacle is detected in front of your vehicle.

Adaptive Brake Assist is then deactivated.

**Important safety notes****⚠ WARNING**

Adaptive Brake Assist cannot always clearly identify objects and complex traffic situations.

In such cases, Adaptive Brake Assist can:

- intervene unnecessarily
- not intervene

There is a risk of an accident.

Always pay careful attention to the traffic situation and be ready to brake. Terminate the intervention in a non-critical driving situation.

### WARNING

Adaptive Brake Assist does not react:

- to people or animals
- to oncoming vehicles
- to crossing traffic
- when cornering

As a result, the Adaptive Brake Assist may not intervene in all critical conditions. There is a risk of an accident.

Always pay careful attention to the traffic situation and be ready to brake.

Due to the nature of the system, particularly complicated but non-critical driving conditions may also cause Adaptive Brake Assist to intervene.

If adaptive Brake Assist is not available due to a malfunction in the radar sensor system, the brake system remains available with full brake boosting effect and BAS.

## ESP® (Electronic Stability Program)

### General notes

-  Observe the "Important safety notes" section (▷ page 68).

ESP® monitors driving stability and traction, i.e. power transmission between the tires and the road surface.

If ESP® detects that the vehicle is deviating from the direction desired by the driver, one or more wheels are braked to stabilize the vehicle. The engine output is also modified to keep the vehicle on the desired course within physical limits. ESP® assists the driver when pulling away on wet or slippery roads. ESP® can also stabilize the vehicle during braking.

## ETS/4ETS (Electronic Traction System)

-  Observe the "Important safety notes" section (▷ page 68).

ETS traction control is part of ESP®. On vehicles with 4MATIC, 4ETS is part of ESP®.

Traction control brakes the drive wheels individually if they spin. This enables you to pull away and accelerate on slippery surfaces, for example if the road surface is slippery on one side. In addition, more drive torque is transferred to the wheel or wheels with traction.

Traction control remains active, even if you deactivate ESP®.

### Important safety notes

#### WARNING

If ESP® is malfunctioning, ESP® is unable to stabilize the vehicle. Additionally, further driving safety systems are deactivated. This increases the risk of skidding and an accident.

Drive on carefully. Have ESP® checked at a qualified specialist workshop.

If the  ESP® OFF warning lamp lights up continuously, then ESP® is deactivated.

If the  ESP® warning lamp lights up continuously, ESP® is not available due to a malfunction.

Observe the information on warning lamps (▷ page 317) and display messages which may be shown in the instrument cluster (▷ page 278).

Only use wheels with the recommended tire sizes. Only then will ESP® function properly.

## Characteristics of ESP®

### General information

If the  ESP warning lamp goes out before beginning the journey, ESP® is automatically active.

If ESP® intervenes, the  ESP® warning lamp flashes in the instrument cluster.

If ESP® intervenes:

- ▶ Do not deactivate ESP® under any circumstances.
- ▶ Only depress the accelerator pedal as far as necessary when pulling away.
- ▶ Adapt your driving style to suit the prevailing road and weather conditions.

### ECO start/stop function

The ECO start/stop function is not available for PLUG-IN HYBRID vehicles.

The ECO start/stop function switches the engine off automatically when the vehicle stops moving. The engine starts automatically when the driver wants to pull away again. ESP® remains in its previously selected status. **Example:** If ESP® was deactivated before the engine was switched off, ESP® remains deactivated when the engine is switched on again.

### Deactivating/activating ESP®

#### Important safety notes

- ❗ Observe the "Important safety notes" section (▷ page 68).

You can select between the following states of ESP®:

- ESP® is activated.
- ESP® is deactivated.

#### WARNING

If you deactivate ESP®, ESP® no longer stabilizes the vehicle. There is an increased risk of skidding and an accident.

Only deactivate ESP® in the situations described in the following.

It may be best to deactivate ESP® in the following situations:

- when using snow chains
  - in deep snow
  - on sand or gravel
- ❗ Activate ESP® as soon as the situations described above no longer apply. ESP® will otherwise not be able to stabilize the vehicle if the vehicle starts to skid or a wheel starts to spin.

- ❗ Avoid spinning the driven wheels for an extended period with ESP® deactivated. You could otherwise damage the drivetrain.

### Deactivating/activating ESP®

You can deactivate or activate ESP® via the on-board computer (▷ page 269).

#### ESP® deactivated:

The  ESP® OFF warning lamp in the instrument cluster lights up.

#### ESP® activated:

The  ESP® OFF warning lamp in the instrument cluster goes out.

### Characteristics when ESP® is deactivated

If ESP® is deactivated and one or more wheels start to spin, the  ESP® warning lamp in the instrument cluster flashes. In such situations, ESP® will not stabilize the vehicle.

If you deactivate ESP®:

- ESP® no longer improves driving stability.
- Engine torque is no longer limited and the drive wheels are able to spin.
  - The spinning of the wheels results in a cutting action for better traction on loose surfaces.
- Traction control is still activated.
- COLLISION PREVENTION ASSIST is no longer available; nor is it activated if you brake firmly with assistance from ESP®.
- PRE-SAFE® is no longer available, nor is it activated if you brake firmly and ESP® intervenes.
- PRE-SAFE® Brake is no longer available, it is also not activated if you brake firmly and ESP® intervenes.
- ESP® still provides support when you brake firmly.

### ESP® trailer stabilization

#### General information

ESP® trailer stabilization is not available in Mercedes-AMG vehicles.

If your vehicle/trailer combination begins to swerve, ESP® assists you in this situation. ESP® slows the vehicle down by braking and limiting the engine output until the vehicle/trailer combination has stabilized.

## Important safety notes

### WARNING

If road and weather conditions are poor, trailer stabilization will not be able to prevent the vehicle/trailer combination from swerving. Trailers with a high center of gravity can tip over before ESP® can detect this. There is a risk of an accident.

Always adapt your driving style to the prevailing road and weather conditions.

If your vehicle with trailer (vehicle/trailer combination) begins to lurch, you can only stabilize the vehicle/trailer combination by depressing the brake firmly.

ESP® trailer stabilization is active above speeds of about 65 km/h.

ESP® trailer stabilization does not work if ESP® is deactivated or disabled because of a malfunction.

## Crosswind Assist (vehicles without MAGIC BODY CONTROL)

### General information

Vehicles with MAGIC BODY CONTROL: information on stabilizing the vehicle in the event of crosswind (> page 210).

Strong crosswinds can cause your vehicle to deviate from a straight course. The crosswind driving assistance function integrated in ESP® noticeably reduces these impairments.

ESP® intervenes automatically according to the direction and intensity of the crosswinds affecting your vehicle.

ESP intervenes with stabilizing braking to assist you in keeping the vehicle in the lane.

Crosswind Assist is active at vehicle speeds above 50 mph (80 km/h) when driving straight ahead or cornering gently.

### Important safety notes

Crosswind Assist does not work if ESP® is switched off or deactivated because of a malfunction.

## EBD (electronic brake force distribution)

### General information

EBD monitors and controls the brake pressure on the rear wheels to improve driving stability while braking.

### Important safety notes

-  Observe the "Important safety notes" section (> page 68).

### WARNING

If EBD is malfunctioning, the rear wheels can lock, e.g. under full braking. This increases the risk of skidding and an accident.

You should therefore adapt your driving style to the different handling characteristics. Have the brake system checked at a qualified specialist workshop.

Observe information regarding indicator and warning lamps (> page 316) as well as display messages (> page 280).

## ADAPTIVE BRAKE

ADAPTIVE BRAKE enhances braking safety and offers increased braking comfort. In addition to the braking function, ADAPTIVE BRAKE also has the HOLD function (> page 208) and hill start assist (> page 165).

## PRE-SAFE® Brake

### General information

PRE-SAFE® Brake can help you to minimize the risk of a collision with a vehicle ahead or a pedestrian, and reduce the effects of such a collision. If PRE-SAFE® Brake has detected a risk of collision, you will be warned visually and acoustically as well as by automatic braking.

-  Pay attention to the important safety notes in the "Driving safety systems" section (> page 68).

PRE-SAFE® Brake is only available in vehicles with the Driving Assistance Plus package.

For PRE-SAFE® Brake to assist you when driving, the radar sensor system and the camera system must be switched on and be operational.

With the help of the radar sensor system and the camera system, PRE-SAFE® Brake can detect obstacles that are in front of your vehicle for an extended period of time.

In addition, pedestrians in the path of your vehicle can be detected.

PRE-SAFE® Brake detects pedestrians using typical characteristics such as the body contours and posture of a person standing upright.

- i** Observe the restrictions described in the "Important safety notes" section (▷ page 76).

### Important safety notes

#### WARNING

PRE-SAFE® Brake will initially brake your vehicle by a partial application of the brakes if a danger of collision is detected. There may be a collision unless you brake yourself. Even after subsequent full application of the brakes a collision cannot always be avoided, particularly when approaching at too high a speed. There is a risk of an accident.

Always apply the brakes yourself and try to take evasive action, provided it is safe to do so.

In the event of a partial application of the brakes, the vehicle is braked with up to 50% of the full braking pressure.

#### WARNING

PRE-SAFE® Brake cannot always clearly identify objects and complex traffic conditions.

In these cases, PRE-SAFE® Brake may:

- give an unnecessary warning and then brake the vehicle
- not give a warning or intervene

There is a risk of an accident.

Always pay particular attention to the traffic situation and be ready to brake, especially if PRE-SAFE® Brake warns you. Terminate the intervention in a non-critical driving situation.

#### WARNING

PRE-SAFE® Brake cannot always clearly identify people, especially if they are moving. In these cases, PRE-SAFE® Brake cannot intervene. There is a risk of an accident.

Always pay particular attention to the traffic situation and be ready to brake, especially if PRE-SAFE® Brake warns you.

In order to maintain the appropriate distance to the vehicle in front and thus prevent a collision, you must apply the brakes yourself.

#### WARNING

PRE-SAFE® Brake does not react:

- to small people, e.g. children
- to animals
- to oncoming vehicles
- to crossing traffic
- when cornering

As a result, PRE-SAFE® Brake may neither give warnings nor intervene in all critical situations. There is a risk of an accident.

Always pay careful attention to the traffic situation and be ready to brake.

In the event of snowfall or heavy rain, the recognition can be impaired.

Recognition by the radar sensor system is also impaired in the event of:

- there is dirt on the sensors or anything else covering the sensors
- there is interference by other radar sources
- there are strong radar reflections, for example in parking garages
- a narrow vehicle traveling in front, e.g. a motorbike
- a vehicle traveling in front on a different line relative to the center of your vehicle

Recognition by the camera system is also impaired in the event of:

- dirt on the camera or if the camera is covered
- there is glare on the camera system, e.g. from the sun being low in the sky

- darkness
- if:
  - pedestrians move quickly, e.g. into the path of the vehicle
  - the camera system no longer recognizes a pedestrian as a person due to special clothing or other objects
  - a pedestrian is concealed by other objects
  - the typical outline of a person is not distinguishable from the background

Following damage to the front end of the vehicle, have the configuration and operation of the radar sensors checked at a qualified specialist workshop. This also applies to collisions at slow speeds where there is no visible damage to the front of the vehicle.

Following damage to the windshield, have the configuration and operation of the camera system checked at a qualified specialist workshop.

## Function

- ▶ **To activate/deactivate:** activate or deactivate PRE-SAFE® Brake in the on-board computer (▷ page 271).

If the PRE-SAFE® Brake is not activated, the  symbol appears in the multifunction display.

Starting at a speed of around 4 mph (7 km/h), this function warns you if you rapidly approach a vehicle in front. An intermittent warning tone will then sound and the  distance warning lamp will light up in the instrument cluster.

- ▶ Brake immediately to defuse the situation.
- or
- ▶ Take evasive action provided it is safe to do so.

PRE-SAFE® Brake can also brake the vehicle automatically under the following conditions:

- the driver and front-passenger have their seat belts fastened and
- the vehicle speed is between approximately 4 mph (7 km/h) and 124 mph (200 km/h)

At speeds of up to approximately 44 mph (70 km/h) PRE-SAFE® Brake can also detect:

- stationary objects in the path of your vehicle, e.g. stopped or parked vehicles
- pedestrians in the path of your vehicle

- ❗ If there is an increased risk of a collision, preventive passenger protection measures (PRE-SAFE®) are triggered (▷ page 59).

If the risk of collision with the vehicle in front remains and you do not brake, take evasive action or accelerate significantly, the vehicle may perform automatic emergency braking, up to the point of full brake application. Automatic emergency braking is not performed until immediately prior to an imminent accident.

You can prevent the intervention of the PRE-SAFE® Brake at any time by:

- depressing the accelerator pedal further.
- activating kickdown.
- releasing the brake pedal.

The braking action of PRE-SAFE® Brake is ended automatically if:

- you maneuver to avoid the obstacle.
- there is no longer a risk of collision.
- there is no longer an obstacle detected in front of your vehicle.

## STEER CONTROL

### General information

STEER CONTROL helps you by transmitting a noticeable steering force to the steering wheel in the direction required for vehicle stabilization. This steering assistance is provided in particular if:

- both right wheels or both left wheels are on a wet or slippery road surface when you brake.
- the vehicle starts to skid.

### Important safety notes

- ❗ Observe the "Important safety notes" section (▷ page 68).

No steering support is provided from STEER CONTROL, if:

- ESP® is deactivated
- ESP® is malfunctioning.
- the lighting is faulty.

Power steering will, however, continue to function.

## Protection against theft

### Immobilizer

The immobilizer prevents your vehicle from being started without the correct SmartKey.

- ▶ **To activate with the SmartKey:** remove the SmartKey from the ignition lock.
- ▶ **To activate with KEYLESS-GO:** switch the ignition off and open the driver's door.
- ▶ **To deactivate:** switch on the ignition.

When leaving the vehicle, always take the SmartKey with you and lock the vehicle. Anyone can start the engine if a valid SmartKey has been left inside the vehicle.

**i** The immobilizer is always deactivated when you start the engine.

In the event that the engine cannot be started (yet the vehicle's battery is charged), the system is not operational. Contact an authorized Mercedes-Benz Center or call 1-800-FOR-MERCEdes (in the USA) or 1-800-387-0100 (in Canada).

### ATA (anti-theft alarm system)



- ▶ **To arm:** lock the vehicle with the SmartKey or KEYLESS-GO.

Indicator lamp **i** flashes. The alarm system is armed after approximately 10 seconds.

- ▶ **To disarm:** unlock the vehicle with the SmartKey or KEYLESS-GO.

or

- ▶ Insert the SmartKey into the ignition lock.

A visual and audible alarm is triggered if the alarm system is armed and you open:

- a door
- the vehicle with the mechanical key

- the trunk lid
- the hood

- ▶ **To turn the alarm off with the SmartKey:** press the  or  button on the SmartKey.

The alarm is switched off.

or

- ▶ Remove the Start/Stop button from the ignition lock.

- ▶ Insert the SmartKey into the ignition lock. The alarm is switched off.

- ▶ **To stop the alarm using KEYLESS-GO:** grasp the outside door handle. The SmartKey must be outside the vehicle.

The alarm is switched off.

or

- ▶ Press the Start/Stop button on the dashboard. The SmartKey must be inside the vehicle.

The alarm is switched off.

The alarm is not switched off, even if you close the open door that triggered it, for example.

- i** If the alarm continues for more than 30 seconds, the mbrace emergency call system automatically notifies the Customer Assistance Center. This is done either by text message or data connection.

The emergency call system sends a message or establishes a data connection provided that:

- you have subscribed to the mbrace service.
- the mbrace service has been activated properly.
- the necessary mobile phone network is available.



## Useful information

- i** This Operator's Manual describes all models and all standard and optional equipment of your vehicle available at the time of publication of the Operator's Manual. Country-specific differences are possible. Please note that your vehicle may not be equipped with all features described. This also applies to safety-related systems and functions.
- i** Read the information on qualified specialist workshops (▷ page 28).

## SmartKey

### Important safety notes

#### WARNING

If children are left unsupervised in the vehicle, they could:

- open the doors, thus endangering other people or road users.
- get out and disrupt traffic.
- operate the vehicle's equipment.

Additionally, children could set the vehicle in motion if, for example, they:

- release the parking brake.
- shifting the automatic transmission out of park position **P**
- Start the engine.

There is a risk of an accident and injury.

When leaving the vehicle, always take the SmartKey with you and lock the vehicle. Never leave children or animals unattended in the vehicle. Always keep the SmartKey out of reach of children.

#### WARNING

If you attach heavy or large objects to the SmartKey, the SmartKey could be unintentionally turned in the ignition lock. This could cause the engine to be switched off. There is a risk of an accident.

Do not attach any heavy or large objects to the SmartKey. Remove any bulky key rings before inserting the SmartKey into the ignition lock.

- !** Keep the SmartKey away from strong magnetic fields. Otherwise, the remote control function could be affected.

Strong magnetic fields can occur in the vicinity of powerful electrical installations.

Do not keep the SmartKey:

- with electronic devices, e.g. a mobile phone or another SmartKey.
  - with metallic objects, e.g. coins or metal foil.
  - inside metallic objects, e.g. a metal case.
- This can affect the functionality of the SmartKey.



Do not keep the SmartKey in the temperature-controlled cup holder (▷ page 332). On vehicles with the KEYLESS-GO start function, do not keep it on the parcel shelf or in the trunk. Otherwise, the SmartKey may not be detected, e.g. when starting the engine using the Start/Stop button.

A check which periodically establishes a radio connection between the vehicle and the SmartKey determines whether a valid SmartKey is in the vehicle. This occurs, for example:

- when starting the engine
- whilst driving
- when using HANDS-FREE ACCESS
- when the external door handles are touched
- during convenience closing

### SmartKey functions



- ①  To lock the vehicle
- ②  To open/close the trunk lid
- ③  To unlock the vehicle

► **To unlock centrally:** press the  button.

If you do not open the vehicle within approximately 40 seconds of unlocking:

- the vehicle is locked again.
- anti-theft protection is reactivated.

► **To lock centrally:** press the  button.

The SmartKey centrally locks and unlocks the following components:

- the doors
- the trunk lid
- the fuel filler flap

The turn signals flash once when unlocking and three times when locking.

You can also set an audible signal to confirm that the vehicle has been locked. The audible signal can be activated and deactivated via the multimedia system; see the separate operating instructions.

You will receive visual and acoustic locking confirmation if all components were able to be locked.

When the locator lighting is activated via the multimedia system, it lights up when it is dark after the vehicle is unlocked with the SmartKey. Information on activating and deactivating the locator lighting can be found in the separate operating instructions.

► **To open the trunk lid automatically from outside the vehicle:** press and hold the  button until the trunk lid opens.

► **To open the trunk lid automatically from outside the vehicle:** if the SmartKey is located in the immediate vicinity of the vehicle, press the  button on the SmartKey. When the trunk lid closes you can then release the button.

## KEYLESS-GO

### General notes

Bear in mind that the engine can be started by any of the vehicle occupants if there is a SmartKey in the vehicle (▷ page 164).

### Locking/unlocking centrally

You can start, lock or unlock the vehicle using KEYLESS-GO. To do this, you only need carry the SmartKey with you. You can combine the func-

tions of KEYLESS-GO with those of a conventional SmartKey. Unlock the vehicle by using KEYLESS-GO, for instance, and lock it using the  button on the SmartKey.

The driver's door and the door at which the handle is used, must both be closed. The SmartKey must be outside the vehicle. When locking or unlocking with KEYLESS-GO, the distance between the SmartKey and the corresponding door handle must not be greater than 3 ft (1 m).

A brief radio connection between the vehicle and the SmartKey determines whether a valid SmartKey is in, or in the direct vicinity of, the vehicle. This occurs, for example:

- when starting the engine
- while driving
- when using HANDS-FREE ACCESS
- when the external door handles are touched
- during convenience closing



► **To unlock the vehicle:** touch the inner surface of the door handle.

► **To lock the vehicle:** touch sensor surface ① or ②.

Make sure that you do not touch the inner surface of the door handle.

► **Convenience closing feature:** touch recessed sensor surface ② for an extended period.

Further information on the convenience closing feature (▷ page 96).

► **To unlock the trunk lid:** pull the handle on the trunk lid.

### Deactivating and activating

If you do not intend to use a SmartKey for an extended period of time, you can deactivate the KEYLESS-GO function of the SmartKey. The SmartKey will then use very little power, thereby

conserving battery power. For the purposes of activation/deactivation, the vehicle must not be nearby.

- ▶ **To deactivate:** press the  button on the SmartKey twice in rapid succession. The battery check lamp (▷ page 82) of the SmartKey flashes twice briefly and lights up once, then KEYLESS-GO is deactivated.
- ▶ **To activate:** press any button on the SmartKey.

or

- ▶ Insert the SmartKey into the ignition lock. KEYLESS-GO and all of its associated features are available again.



### KEYLESS-GO start function



#### General notes

Bear in mind that the engine can be started by any of the vehicle occupants if there is a SmartKey in the vehicle (▷ page 164).

### Changing the settings of the locking system

You can change the settings of the locking system. This means that only the driver's door and the fuel filler flap are unlocked when the vehicle is unlocked. This is useful if you frequently travel on your own.

- ▶ **To change the setting:** press and hold down the  and  buttons simultaneously for approximately six seconds until the battery check lamp flashes twice (▷ page 82).



If the setting of the locking system is changed within the signal range of the vehicle, pressing the  or  button:

- locks or
- unlocks the vehicle

The SmartKey now functions as follows:

- ▶ **To unlock:** press the  button once.
- ▶ **To unlock centrally:** press the  button twice.
- ▶ **To lock:** press the  button.

The KEYLESS-GO function is changed as follows:

- ▶ **To unlock the driver's door:** touch the inner surface of the door handle on the driver's door.
- ▶ **To unlock centrally:** touch the inner surface of the door handle on the front-passenger door or the rear door.
- ▶ **To lock centrally:** touch the outer sensor surface on one of the door handles.
- ▶ **To restore the factory settings:** press and hold the  and  buttons simultaneously for approximately six seconds until the battery check lamp flashes twice (▷ page 82).

### Mechanical key

#### General notes

If the vehicle can no longer be locked or unlocked with the SmartKey or KEYLESS-GO, use the mechanical key.

If you use the mechanical key to unlock and open the driver's door, the anti-theft alarm system will be triggered. Switch off the alarm (▷ page 78).

If you unlock the vehicle using the mechanical key, the fuel filler flap will not be unlocked automatically.

- ▶ **To unlock the fuel filler flap:** insert the SmartKey into the ignition lock.

### Removing the mechanical key



- ▶ Push release catch ① in the direction of the arrow and at the same time remove mechanical key ② from the SmartKey.

For further information about:

- unlocking the driver's door (▷ page 87)
- unlocking the trunk (▷ page 93)
- locking the vehicle (▷ page 88)

### Inserting the mechanical key

- ▶ Push mechanical key ② completely into the SmartKey until it engages and release catch ① is back in its basic position.

### SmartKey battery

### Important safety notes

#### ⚠ WARNING

Batteries contain toxic and corrosive substances. If batteries are swallowed, it can result in severe health problems. There is a risk of fatal injury.

Keep batteries out of the reach of children. If a battery is swallowed, seek medical attention immediately.

#### ♻ Environmental note



Batteries contain dangerous substances. It is against the law to dispose of them with the household rubbish. They must be collected separately and recycled to protect the environment.



Dispose of batteries in an environmentally friendly manner. Take discharged batteries to a qualified specialist workshop or a special collection point for used batteries.

The SmartKey batteries contain perchlorate material, which may require special handling and regard for the environment. National guidelines must be observed during disposal. In California, see [www.dtsc.ca.gov/HazardousWaste/Perchlorate/index.cfm](http://www.dtsc.ca.gov/HazardousWaste/Perchlorate/index.cfm).

Mercedes-Benz recommends that you have the batteries replaced at a qualified specialist workshop.

### Checking the battery



- ▶ Press the or button. The battery is working properly if battery check lamp ① lights up briefly. The battery is discharged if battery check lamp ① does not light up briefly.

- ▶ Change the battery (▷ page 82).

If the SmartKey battery is checked within the signal reception range of the vehicle, pressing the or button:

- locks or
- unlocks the vehicle

- ⓘ You can obtain a battery from any qualified specialist workshop.

### Replacing the battery

You require a CR 2025 3 V cell battery.

- ▶ Take the mechanical key out of the SmartKey (▷ page 81).

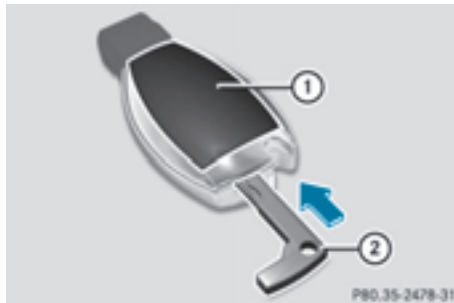

- ▶ Press mechanical key ② into the SmartKey opening in the direction of the arrow until bat-

tery compartment cover ① opens. Do not hold battery compartment cover ① closed while doing so.

- ▶ Remove battery compartment cover ①.

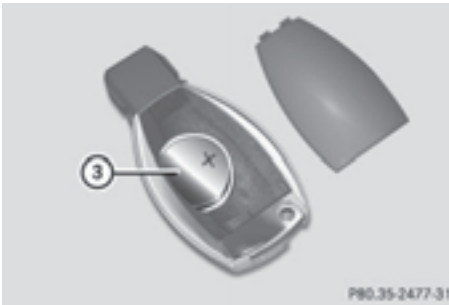

- ▶ Repeatedly tap the SmartKey against your palm until battery ③ falls out.
- ▶ Insert the new battery with the positive terminal facing upwards. Use a lint-free cloth to do so.
- ▶ Make sure that the surface of the battery is free of lint, grease and other contaminants.
- ▶ Insert the front tabs of battery compartment cover ① into the housing first and then press to close it.
- ▶ Insert mechanical key ② into the SmartKey (> page 82).
- ▶ Check the function of all SmartKey buttons on the vehicle.

## Problems with the SmartKey

Problem	Possible causes/consequences and ► Solutions
<p>You can no longer lock or unlock the vehicle using the SmartKey.</p>	<p>The SmartKey battery is discharged or nearly discharged.</p> <ul style="list-style-type: none"> <li>► Check the SmartKey battery (▷ page 82) and replace it if necessary (▷ page 82).</li> </ul> <p>If this does not work:</p> <ul style="list-style-type: none"> <li>► Unlock (▷ page 87) or lock (▷ page 88) the vehicle using the mechanical key.</li> </ul>
	<p>There is interference from a powerful source of radio waves.</p> <ul style="list-style-type: none"> <li>► Unlock (▷ page 87) or lock (▷ page 88) the vehicle using the mechanical key.</li> </ul>
	<p>The SmartKey is faulty.</p> <ul style="list-style-type: none"> <li>► Unlock (▷ page 87) or lock (▷ page 88) the vehicle using the mechanical key.</li> <li>► Have the SmartKey checked at a qualified specialist workshop.</li> </ul>
<p>You can no longer lock or unlock the vehicle using KEYLESS-GO.</p>	<p>KEYLESS-GO was deactivated.</p> <ul style="list-style-type: none"> <li>► Reactivate KEYLESS-GO (▷ page 80).</li> </ul>
	<p>The SmartKey battery is discharged or nearly discharged.</p> <ul style="list-style-type: none"> <li>► Check the SmartKey battery (▷ page 82) and replace it if necessary (▷ page 82).</li> </ul> <p>If this does not work:</p> <ul style="list-style-type: none"> <li>► Unlock (▷ page 87) or lock (▷ page 88) the vehicle using the mechanical key.</li> </ul>
	<p>There is interference from a powerful source of radio waves.</p> <ul style="list-style-type: none"> <li>► Unlock (▷ page 87) or lock (▷ page 88) the vehicle using the mechanical key.</li> </ul>
	<p>KEYLESS-GO is malfunctioning.</p> <ul style="list-style-type: none"> <li>► Lock/unlock the vehicle using the remote control function of the SmartKey.</li> <li>► Have the vehicle and SmartKey checked at a qualified specialist workshop.</li> </ul>
	<p>If the vehicle can also not be locked/unlocked using the remote control function:</p> <ul style="list-style-type: none"> <li>► Lock (▷ page 87) or unlock (▷ page 88) the vehicle using the mechanical key.</li> <li>► Have the vehicle and SmartKey checked at a qualified specialist workshop.</li> </ul>

Problem	Possible causes/consequences and ► Solutions
The engine cannot be started using the SmartKey.	<p>The on-board voltage is too low.</p> <ul style="list-style-type: none"> <li>► Switch off non-essential consumers, e.g. seat heating or interior lighting, and try to start the engine again.</li> </ul> <p>If this does not work:</p> <ul style="list-style-type: none"> <li>► Check the starter battery and charge it if necessary (▷ page 374).</li> <li>or</li> <li>► Jump-start the vehicle (▷ page 376).</li> <li>or</li> <li>► Consult a qualified specialist workshop.</li> </ul>
The engine cannot be started using the Start/Stop button. The SmartKey is in the vehicle.	<p>The vehicle is locked.</p> <ul style="list-style-type: none"> <li>► Unlock the vehicle and try to start the vehicle again.</li> </ul> <p>The SmartKey battery is discharged or nearly discharged.</p> <ul style="list-style-type: none"> <li>► Check the SmartKey battery (▷ page 82) and replace it if necessary (▷ page 82).</li> </ul> <p>If this does not work:</p> <ul style="list-style-type: none"> <li>► Start your vehicle with the SmartKey in the ignition lock.</li> </ul> <p>There is interference from a powerful source of radio waves.</p> <ul style="list-style-type: none"> <li>► Start your vehicle with the SmartKey in the ignition lock.</li> </ul>
You have lost a SmartKey.	<ul style="list-style-type: none"> <li>► Have the SmartKey deactivated at a qualified specialist workshop.</li> <li>► Report the loss immediately to the vehicle insurers.</li> <li>► If necessary, have the locks changed as well.</li> </ul>
You have lost the mechanical key.	<ul style="list-style-type: none"> <li>► Report the loss immediately to the vehicle insurers.</li> <li>► If necessary, have the locks changed as well.</li> </ul>

## Doors

### Important safety notes

#### WARNING

If children are left unsupervised in the vehicle, they could:

- open the doors, thus endangering other people or road users.
- get out and disrupt traffic.
- operate the vehicle's equipment.

Additionally, children could set the vehicle in motion if, for example, they:

- release the parking brake.
- shifting the automatic transmission out of park position **P**
- Start the engine.

There is a risk of an accident and injury.

When leaving the vehicle, always take the SmartKey with you and lock the vehicle. Never leave children or animals unattended in the vehicle. Always keep the SmartKey out of reach of children.

### Unlocking and opening doors from the inside

You can open a door from inside the vehicle even if it has been locked. You can only open the rear doors from inside the vehicle if they are not secured by the child-proof locks (▷ page 67). If the vehicle has been locked with the SmartKey or with KEYLESS-GO, opening a door from the inside will trigger the anti-theft alarm system. Switch off the alarm (▷ page 78).



- ▶ **To unlock and open a front door:** pull door handle ②.  
If the door is locked, locking knob ① pops up. The door is unlocked and opens.
- ▶ **To unlock a rear door:** pull door handle ②. Locking knob ① pops up and the door unlocks.
- ▶ **To open a rear door:** pull door handle ② again.  
The door opens.

### Centrally locking and unlocking the vehicle from the inside

You can centrally lock and unlock the vehicle from the inside. The buttons are located on both front doors.



- ▶ **To unlock:** press button ①.
- ▶ **To lock:** press button ②.  
If the front-passenger door is closed, the vehicle locks.  
If the driver's door is open, the door stays unlocked.

Meanwhile, the fuel filler flap will not be locked or unlocked.

You cannot unlock the vehicle centrally from the inside if the vehicle has been locked with the SmartKey or KEYLESS-GO.

The doors can be opened from the inside. You can only open the rear doors from inside the vehicle if they are not secured by the child-proof locks (▷ page 67).

If the vehicle has been locked with the SmartKey or with KEYLESS-GO, opening a door from the inside will trigger the anti-theft alarm system. Switch off the alarm (▷ page 78).

If a locked door is opened from the inside, the previous unlock status of the vehicle will be taken into consideration if:

- the vehicle was locked using the locking button for the central locking, or
- if the vehicle was locked automatically

The vehicle will be fully unlocked if it had previously been fully unlocked. If only the driver's door had been previously unlocked, only the door which has been opened from the inside is unlocked.



### Automatic locking feature



- ▶ **To deactivate:** press and hold button ① for approximately five seconds until a tone sounds.
- ▶ **To activate:** press and hold button ② for approximately five seconds until a tone sounds.

If you press one of the two buttons and do not hear a tone, the relevant setting has already been selected.

The vehicle is locked automatically when the ignition is switched on and the wheels are turning.

You could therefore be locked out if:

- the vehicle is being pushed.
- the vehicle is being towed.
- the vehicle is on a roller dynamometer.

You can also switch the automatic locking function on and off using the multimedia system; see the separate operating instructions.

### Power closing

Power closing pulls the doors and trunk lid into their locks automatically even if they are only partly closed.

- ▶ **To power close a door:** push the door into the lock up to the first detent position. Power closing will pull the door fully closed.
- ▶ **To power close the trunk lid:** lightly push the trunk lid closed. The power closing function pulls the trunk lid closed.

### Unlocking the driver's door (mechanical key)

If the vehicle can no longer be locked or unlocked with the SmartKey or KEYLESS-GO, use the mechanical key.

- ▶ Take the mechanical key out of the SmartKey (▷ page 81).



- ▶ Insert the mechanical key as far as it will go into opening ① in the protective cap.
- ▶ Pull and hold the door handle.
- ▶ Pull the protective cap on the mechanical key as straight as possible away from the vehicle until it releases.
- ▶ Release the door handle.

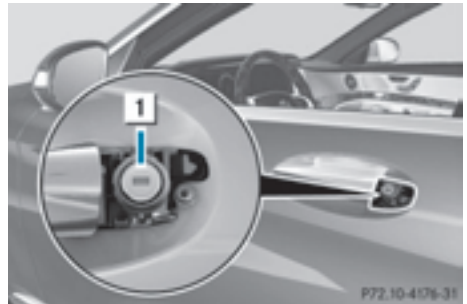

- ▶ Insert the mechanical key into the lock of the driver's door as far as it will go.
- ▶ Turn the mechanical key counter-clockwise as far as it will go to position ①. The locking knob pops up and the door unlocks.
- ▶ Turn the mechanical key back and remove it.
- ▶ Insert the mechanical key into the SmartKey (▷ page 82).
- ▶ Carefully press the protective cap onto the lock cylinder until it engages and is seated

firmly. Do not pull the door handle when doing so.

If you use the mechanical key to unlock and open the driver's door, the anti-theft alarm system will be triggered. Switch off the alarm (▷ page 78).

### Locking the vehicle (mechanical key)

If the vehicle can no longer be locked with the SmartKey or KEYLESS-GO, use the mechanical key.

- ▶ Open the driver's door.
- ▶ Close the front-passenger door, the rear doors and the trunk lid.
- ▶ Press the locking button (▷ page 86).
- ▶ Check whether the locking knobs on the front-passenger door and the rear doors are still visible. Press down the locking knobs by hand, if necessary.
- ▶ Close the driver's door.
- ▶ Take the mechanical key out of the SmartKey (▷ page 81).

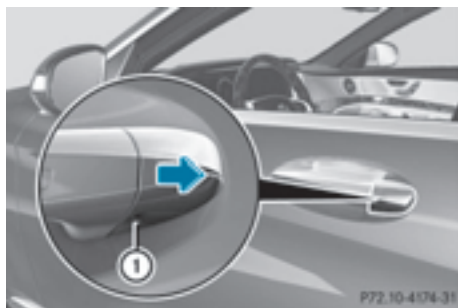

- ▶ Insert the mechanical key as far as it will go into opening ① in the protective cap.
- ▶ Pull and hold the door handle.
- ▶ Pull the protective cap on the mechanical key as straight as possible away from the vehicle until it releases.
- ▶ Release the door handle.

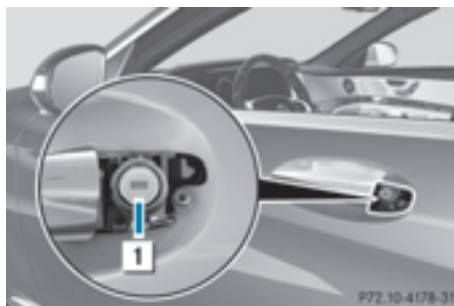

- ▶ Insert the mechanical key into the lock of the driver's door as far as it will go.
- ▶ Turn the mechanical key clockwise as far as it will go to position ①. The locking knob drops down and the driver's door is locked.
- ▶ Turn the mechanical key back and remove it.
- ▶ Make sure that the doors and the trunk lid are locked.
- ▶ Insert the mechanical key into the SmartKey (▷ page 82).
- ▶ Carefully press the protective cap onto the lock cylinder until it engages and is seated firmly. Do not pull the door handle when doing so.

If you lock the vehicle as described above, the fuel filler flap is not locked. The anti-theft alarm system is not armed.

## Trunk

### Important safety notes

#### WARNING

Combustion engines emit poisonous exhaust gases such as carbon monoxide. Exhaust gases can enter the vehicle interior if the trunk lid is open when the engine is running, especially if the vehicle is in motion. There is a risk of poisoning.

Always switch off the engine before opening the trunk lid. Never drive with the trunk lid open.

#### WARNING

If objects, luggage or loads are not secured or not secured sufficiently, they could slip, tip

over or be flung around and thereby hit vehicle occupants. There is a risk of injury, particularly in the event of sudden braking or a sudden change in direction.

Always store objects so that they cannot be flung around. Secure objects, luggage or loads against slipping or tipping before the journey.

**!** The trunk lid swings upwards when opened. Therefore, make sure that there is sufficient clearance above the trunk lid.

The opening dimensions of the trunk lid can be found in the "Vehicle data" section (▷ page 433).

Do not leave the SmartKey in the trunk. You could otherwise lock yourself out.

You should preferably place luggage or loads in the trunk. Observe the loading guidelines (▷ page 325).

### Obstruction detection with reversing feature for the trunk lid

**Vehicles with trunk lid remote closing feature:** the trunk lid is equipped with automatic obstacle recognition with reversing feature. If a solid object blocks or restricts the trunk lid when automatically opening or closing, this procedure is stopped. If the trunk lid is stopped during the closing procedure, it will open again automatically. The automatic obstacle recognition with reversing feature is only an aid. It is not a substitute for your attentiveness when opening and closing the trunk lid.

#### **⚠ WARNING**

The reversing feature does not react:

- to soft, light and thin objects, e.g. small fingers
- over the last 1/3 in (8 mm) of the closing movement

This means that the reversing feature cannot prevent someone being trapped in these situations. There is a risk of injury.

Make sure that no body parts are in close proximity during the closing procedure.

If somebody becomes trapped:

- press the  button on the SmartKey, or
- pull or press the remote operating switch on the driver's door or
- press the closing or locking button on the trunk lid, or
- pull on the trunk lid handle

**Vehicles with HANDS-FREE ACCESS:** it is also possible to stop the closing process by performing a kicking movement under the rear bumper.

### Opening and closing manually

#### Opening



- ▶ Press the  button on the SmartKey, or
- ▶ Pull handle ①.  
The trunk lid opens.

#### Closing



- ▶ Pull the trunk lid down using recess ①.

### Vehicles with trunk lid remote closing feature or power closing:

- ▶ Lightly push the trunk lid closed.  
The power closing function pulls the trunk lid closed.
- ▶ Lock the vehicle if necessary with the  button on the SmartKey or with KEYLESS-GO (> page 80).
- ❗ If KEYLESS-GO detects a SmartKey in the trunk, the trunk lid cannot be locked. It then opens again.

### Opening/closing automatically from outside

#### Important safety notes

#### WARNING

Parts of the body could become trapped during automatic closing of the trunk lid. Moreover, people, e.g. children, may be standing in the closing area or may enter the closing area during the closing process. There is a risk of injury.

Make sure that nobody is in the vicinity of the closing area during the closing process.

Use one of the following options to stop the closing process:

- press the  button on the SmartKey.
- pull or press the remote operating switch on the driver's door.
- press the closing or locking button on the trunk lid.
- pull the trunk lid handle

**Vehicles with HANDS-FREE ACCESS:** it is also possible to stop the closing process by performing a kicking movement under the rear bumper.

#### WARNING

Combustion engines emit poisonous exhaust gases such as carbon monoxide. Exhaust gases can enter the vehicle interior if the trunk lid is open when the engine is running, especially if the vehicle is in motion. There is a risk of poisoning.

Always switch off the engine before opening the trunk lid. Never drive with the trunk lid open.

- ❗ The trunk lid swings upwards when opened. Therefore, make sure that there is sufficient clearance above the trunk lid.

The opening dimensions of the trunk lid can be found in the "Vehicle data" section (> page 433).

### Opening



You can open the trunk lid automatically using the SmartKey or the handle in the trunk lid.

- ▶ Press and hold the  button on the SmartKey until the trunk lid opens.
- or
- ▶ If the trunk lid is unlocked, pull the trunk lid handle and let it go again immediately.

### Closing

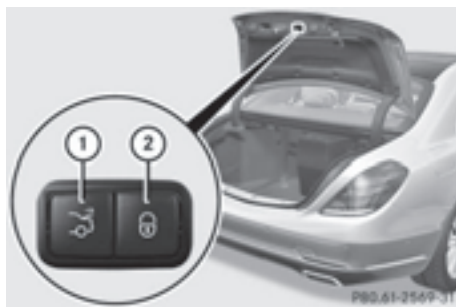
You can close the trunk lid automatically using the SmartKey or the closing button in the trunk lid.



- ▶ Press closing button ① on the trunk lid.
- or
- ▶ If the SmartKey is located in the immediate vicinity of the vehicle: press the  button on the SmartKey.  
You can release the button as soon as the trunk lid starts to close.
  - ▶ **To stop the closing process:**
    - Press the  button on the SmartKey or
    - Pull the trunk lid handle, or
    - Press closing button ① or locking button ② on the trunk lid, or

- Press the remote operating switch on the driver's door, or
- In vehicles with HANDS-FREE ACCESS: kick into the sensor detection range under the bumper with your foot.

**i** If the  button on the SmartKey is pressed or HANDS-FREE ACCESS is initiated after the closing process is stopped, the trunk lid opens.

**Vehicles with trunk lid remote closing feature and KEYLESS-GO:** when all the doors are closed, you can simultaneously close the trunk lid and lock the vehicle. The SmartKey must be located to the rear of the vehicle.

► Press and release locking button **2** on the trunk lid.

If a KEYLESS-GO key is detected outside the vehicle, the trunk lid closes and the vehicle locks.

If KEYLESS-GO detects a second SmartKey outside the vehicle, the trunk lid remains closed.

If KEYLESS-GO detects a SmartKey in the trunk, the trunk lid opens again after it is closed.

## HANDS-FREE ACCESS

### Important safety notes

#### WARNING

The vehicle's exhaust system may be very hot. You could burn yourself by touching the exhaust system if you use HANDS-FREE ACCESS. There is a risk of injury. Always ensure that you only make the kicking movement within the detection range of sensors.

**!** If the SmartKey is within the rear detection range of KEYLESS-GO, the following situations, for example, could lead to the unintentional opening of the trunk:

- using a car wash
- using a power washer

Make sure that the SmartKey is at least 10 ft (3 m) away from the vehicle.

### General notes

With KEYLESS-GO and HANDS-FREE ACCESS, you can open or close the trunk lid or stop the procedure without using your hands. This is use-

ful if you have your hands full. To do this, make a kicking movement under the bumper with your foot.

Observe the following points:

- Carry your KEYLESS-GO key about your person. The KEYLESS-GO key must be in the rear detection range of the vehicle.
- When making the kicking movement, make sure that you are standing firmly on the ground and that there is sufficient clearance to the rear of the vehicle. You could otherwise lose your balance e.g. on ice.



- Always ensure that you only make the kicking movement within the detection range of sensors **1**.
- Stand at least 12 in (30 cm) away from the rear area while doing so.
- Do not come into contact with the bumper while making the kicking movement. Otherwise, the sensors may not function correctly.
- HANDS-FREE ACCESS does not function when the engine is started.
- Dirt caused by road salt around sensors **1** may restrict functionality.
- Using the HANDS-FREE ACCESS with a prosthetic leg may restrict functionality.
- If a KEYLESS-GO key is within the rear detection range of KEYLESS-GO, HAND-FREE ACCESS could be triggered. The trunk lid could thus be opened or closed unintentionally, for example, if you:
  - sit on the edge of the trunk.
  - set something down or lift something up behind the vehicle.
  - move the charging cable through the detection range of the sensors.
  - polish the rear of the vehicle.

Do not carry the KEYLESS-GO key about your person in these situations or in situations sim-

ilar to these. This will prevent the unintentional opening/closing of the trunk.

## Operation

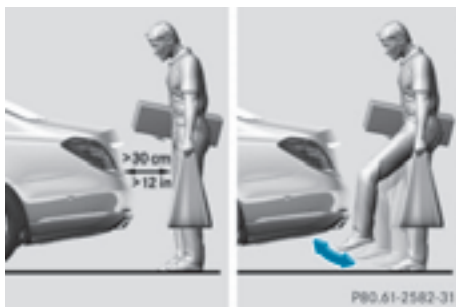

► **To open/close:** kick into sensor detection range ① under the bumper with your foot. A warning tone will sound while the trunk lid is opening or closing.

► **If the trunk lid does not open/close after several attempts:** wait at least ten seconds and then using your foot kick under the bumper again.

If you hold your foot under the bumper for too long, the trunk lid does not open or close. Repeat the leg movement more quickly if this occurs.

To stop the opening or closing procedure:

- kick with your leg in the sensor detection range ① under the bumper or
- pull the handle on the outside of the trunk lid or
- press the closing button on the trunk lid, or
- press the  button on the SmartKey

If the trunk lid closing procedure has been stopped:

- move your foot under the bumper again and the trunk lid will open

If the trunk lid opening procedure has been stopped:

- move your foot under the bumper again and the trunk lid will close

## Opening/closing automatically from inside

### Important safety notes

#### WARNING

The reversing feature does not react:

- to soft, light and thin objects, e.g. small fingers
- over the last 1/3 in (8 mm) of the closing movement

This means that the reversing feature cannot prevent someone being trapped in these situations. There is a risk of injury.

Make sure that no body parts are in close proximity during the closing procedure.

If somebody becomes trapped:

- press the  button on the SmartKey, or
- pull or press the remote operating switch on the driver's door or
- press the closing or locking button on the trunk lid, or
- pull on the trunk lid handle

**Vehicles with HANDS-FREE ACCESS:** it is also possible to stop the closing process by performing a kicking movement under the rear bumper.

#### WARNING

Combustion engines emit poisonous exhaust gases such as carbon monoxide. Exhaust gases can enter the vehicle interior if the trunk lid is open when the engine is running, especially if the vehicle is in motion. There is a risk of poisoning.

Always switch off the engine before opening the trunk lid. Never drive with the trunk lid open.

 The trunk lid swings upwards when opened. Therefore, make sure that there is sufficient clearance above the trunk lid.

The opening dimensions of the trunk lid can be found in the "Vehicle data" section (> page 433).

## Opening and closing



- ▶ **To open:** pull the remote operating switch for trunk lid ① until the trunk lid opens.
- ▶ **To close:** press and hold remote operating switch ① for the trunk lid until the trunk lid is completely closed.

When the vehicle is stationary, you can close the trunk lid from the driver's seat. When the vehicle is also unlocked, you can also open the trunk lid from inside.

### Locking the trunk separately

You can lock the trunk separately. If you then unlock the vehicle centrally, the trunk remains locked and cannot be opened.

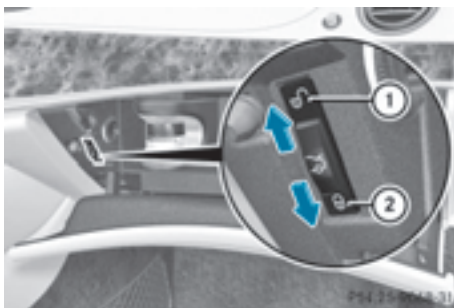

Activating the function to lock the trunk separately:

- ▶ Close the trunk lid.
- ▶ Open the glove box.
- ▶ Push the switch to position ②. If the vehicle is unlocked centrally, the trunk remains locked.

**i** You can also lock the glove box (▷ page 326).

Deactivating the function to lock the trunk separately:

- ▶ Open the glove box.
- ▶ Push the switch to position ①. If the vehicle is unlocked centrally, the trunk will also be unlocked.

### Unlocking the trunk (mechanical key)

**!** The trunk lid swings upwards when opened. Therefore, make sure that there is sufficient clearance above the trunk lid.

If the trunk lid can no longer be unlocked:

- using the SmartKey, or
- using HANDS-FREE ACCESS, or
- using the remote operating switch in the door control panel:

Use the emergency release.

If you use the mechanical key to unlock and open the trunk lid, the anti-theft alarm system will be triggered. Switch off the alarm (▷ page 78).

- ▶ Take the mechanical key out of the SmartKey (▷ page 81).
- ▶ Insert the mechanical key into the trunk lid lock as far as it will go.

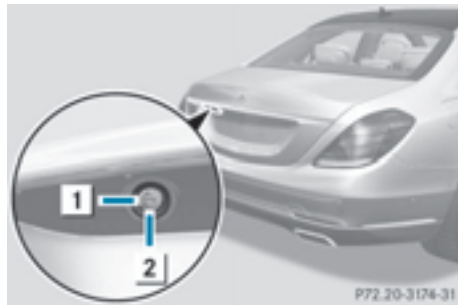

- ▶ Turn the mechanical key from position ① counter-clockwise as far as it will go to position ②. The trunk is unlocked.
- ▶ Turn the mechanical key back to position ① and remove it.
- ▶ Insert the mechanical key into the SmartKey (▷ page 82).

### Trunk emergency release from the inside

You can unlock the trunk lid from the inside with the emergency release button.



- ▶ Press emergency release button ① briefly. The trunk lid unlocks and opens.

The trunk lid can be unlocked with the trunk lid emergency release when the vehicle is stationary or while driving.

The trunk lid emergency release does not unlock the trunk lid if the battery is disconnected or discharged.

Trunk lid emergency release light:

- emergency release button ① flashes for 30 minutes after the trunk lid is opened
- emergency release button ① flashes for 60 minutes after the trunk lid is closed

## Side windows

### Important safety notes

#### WARNING

While opening the side windows, body parts could become trapped between the side window and the door frame as the side window moves. There is a risk of injury.

Make sure that nobody touches the side window during the opening procedure. If somebody becomes trapped, release the switch or pull the switch to close the side window again.

#### WARNING

While closing the side windows, body parts in the closing area could become trapped. There is a risk of injury.

When closing make sure that no parts of the body are in the closing area. If somebody becomes trapped, release the switch or press the switch to open the side window again.

#### WARNING

If children operate the side windows they could become trapped, particularly if they are left unsupervised. There is a risk of injury.

Activate the override feature for the rear side windows. When leaving the vehicle, always take the SmartKey with you and lock the vehicle. Never leave children unsupervised in the vehicle.

### Side window reversing feature

The side windows are equipped with an automatic reversing feature. If a solid object blocks or restricts a side window from traveling upwards during the automatic closing process, the side window opens again automatically. During the manual closing process, the side window only opens again automatically after the corresponding switch is released. The automatic reversing feature is only an aid and is no substitute for your attention when closing a side window.

#### WARNING

The reversing feature does not react:

- to soft, light and thin objects, e.g. small fingers
- while resetting

This means that the reversing feature cannot prevent someone being trapped in these situations. There is a risk of injury.

Make sure that no body parts are in close proximity during the closing procedure. If someone becomes trapped, press the switch to open the side window again.



## Opening and closing the side windows

The switches for all side windows are located on the driver's door. There is also a switch on each door for the corresponding side window.

The switches on the driver's door take precedence.



- ① Front left
- ② Front right
- ③ Rear right
- ④ Rear left

- ▶ Turn the SmartKey to position **1** or **2** in the ignition lock.
- ▶ **To open manually:** press and hold the corresponding button.
- ▶ **To open fully:** press the switch beyond the point of resistance and release it. Automatic operation is started.
- ▶ **To close manually:** pull and hold the corresponding button.
- ▶ **To close fully:** pull the corresponding button beyond the point of resistance. Automatic operation is started.
- ▶ **To interrupt automatic operation:** press/pull the corresponding switch again.

If you press the switch beyond the point of resistance and release, automatic operation is started in the corresponding direction. You can stop automatic operation by pressing/pulling the switch again.

You can continue to operate the side windows after you switch off the engine or remove the SmartKey. This function remains active for five minutes or until you open a front door.

The side windows cannot be operated from the rear when the override feature for the side windows is activated (▷ page 67).

Before opening or closing the side windows, a check is carried out to see whether a valid SmartKey is in the vehicle. The check is carried out if you use the start/stop button instead of a SmartKey in the ignition and you press or pull a button while the engine is switched off. This is carried out by means of a brief radio connection between the vehicle and the SmartKey.

Information on opening and closing the roller sunblinds on the rear side windows (▷ page 333).

## Convenience opening

### General notes

If the SmartKey is in close proximity to the vehicle, the convenience opening function is available.



You can ventilate the vehicle before you start driving.

To do this, the SmartKey is used to carry out the following functions simultaneously:

- unlock the vehicle
- open the side windows
- open the panorama roof with power tilt/sliding panel and the roller sunblinds
- switch on the seat ventilation for the driver's seat

The "convenience opening" feature is also available when the vehicle is unlocked.

### Convenience opening

- ▶ Press and hold the  button until the side windows and the panorama sunroof are in the desired position. If the roller sunblinds of the panorama roof with power tilt/sliding panel are closed, the roller sunblinds are opened first.
- ▶ Keep the  button pressed until the panorama roof with power tilt/sliding panel is in the desired position.
- ▶ **To interrupt convenience opening:** release the  button.

## Convenience closing feature

### Important safety notes

#### WARNING

When the convenience closing feature is operating, parts of the body could become trapped in the closing area of the side window and the sliding sunroof. There is a risk of injury.

Observe the complete closing procedure when the convenience closing feature is operating. Make sure that no body parts are in close proximity during the closing procedure.

When you lock the vehicle, you can simultaneously:



- close the side windows
- close the panorama roof with power tilt/sliding panel

On vehicles with a panorama roof with power tilt/sliding panel, you can then close the roller sunblinds.

 Notes on the automatic reversing feature for:

- the side window (▷ page 94)
- the panorama roof with power tilt/sliding panel (▷ page 98)
- the roller sunblinds (▷ page 99)





### Using the SmartKey

- ▶ Press and hold the  button until the side windows and the panorama roof with power tilt/sliding panel are fully closed.
- ▶ Make sure that all the side windows and the panorama roof with power tilt/sliding panel are closed.
- ▶ **On vehicles with a panorama roof with power tilt/sliding panel:** press and hold the  button again until the roller sunblinds of the panorama roof with power tilt/sliding panel close.
- ▶ **To interrupt convenience closing:** release the  button.

### Using KEYLESS-GO

The SmartKey must be outside the vehicle. All the doors must be closed.



- ▶ Touch recessed sensor surface  on the door handle until the side windows and the panorama roof with power tilt/sliding panel are fully closed.
-  Make sure you only touch recessed sensor surface .
- ▶ Make sure that all the side windows and the panorama roof with power tilt/sliding panel are closed.
- ▶ **Vehicles with a panorama roof with power tilt/sliding panel:** touch recessed sensor surface  on the door handle again until the roller sunblinds of the panorama roof with power tilt/sliding panel close.
- ▶ **To interrupt convenience closing:** release recessed sensor surface  on the door handle.

### Resetting the side windows

If a side window can no longer be closed fully, you must reset it.

- ▶ Close all the doors.
- ▶ Turn the SmartKey to position **1** or **2** in the ignition lock.
- ▶ Pull the corresponding switch on the door control panel until the side window is completely closed (▷ page 95).
- ▶ Hold the switch for an additional second.

If the side window opens again slightly:

- ▶ Immediately pull the corresponding switch on the door control panel until the side window is completely closed (▷ page 95).
- ▶ Hold the switch for an additional second.
- ▶ If the respective side window remains closed after the button is released, then it has been set correctly. If this is not the case, repeat the steps above.

## Problems with the side windows

### WARNING

If you close a side window again immediately after it has been blocked or reset, the side window closes with increased or maximum force. The reversing feature is then not active. Parts of the body could be trapped in the closing area in the process. This poses an increased risk of injury or even fatal injury.

Make sure that no parts of the body are in the closing area. To stop the closing process, release the switch or push the switch again to reopen the side window.

Problem	Possible causes/consequences and ► Solutions
A side window cannot be closed because it is blocked by objects, e.g. leaves in the window guide.	<ul style="list-style-type: none"> <li>► Remove the objects.</li> <li>► Close the side window.</li> </ul>
A side window cannot be closed and you cannot see the cause.	<p>If a side window is obstructed during closing and reopens again slightly:</p> <ul style="list-style-type: none"> <li>► Immediately after the window blocks, pull the corresponding switch again until the side window has closed. The side window is closed with increased force.</li> </ul> <p>If a side window is obstructed again during closing and reopens again slightly:</p> <ul style="list-style-type: none"> <li>► Immediately after the window blocks, pull the corresponding switch again until the side window has closed. The sliding sunroof is closed without the automatic reversing feature.</li> </ul>

## Panorama roof with power tilt/sliding panel

### Important safety notes

In the following section, the term "sliding sunroof" refers to the panorama roof with power tilt/sliding panel.

### WARNING

While opening and closing the sliding sunroof, body parts in close proximity could become trapped. There is a risk of injury.

Make sure that no body parts are in close proximity during the opening and closing procedures.

If somebody becomes trapped:

- release the switch immediately, or
- during automatic operation, push the switch briefly in any direction

The opening or closing procedure will be stopped.

### WARNING

If children operate the sliding sunroof they could become trapped, particularly if they are left unsupervised. There is a risk of injury.

When leaving the vehicle, always take the SmartKey with you and lock the vehicle. Never leave children unsupervised in the vehicle.

**⚠ WARNING**

At high speeds the raised sliding sunroof automatically lowers slightly at the rear. This could trap you or other persons. There is a risk of injury. Make sure that nobody reaches into the sweep of the sliding sunroof whilst the vehicle is in motion.

If somebody becomes trapped, immediately push the sliding sunroof switch up or pull it back. The sliding sunroof raises at the rear.

**!** Only open the sliding sunroof if it is free of snow and ice. Otherwise, malfunctions may occur.

Do not allow anything to protrude from the sliding sunroof. Otherwise, the seals could be damaged.

**!** The weather can change abruptly. It could start to rain or snow. Make sure that the sliding sunroof is closed when you leave the vehicle. The vehicle electronics can be damaged if water enters the vehicle interior.

**!** When the sliding sunroof is open, water can get into the vehicle and cause damage. The vehicle electronics can be damaged if water enters the vehicle interior. Only clean the sliding sunroof when it is closed.

Resonance noises can occur in addition to the usual airflow noises when the sliding sunroof is open. They are caused by minor pressure fluctuations in the vehicle interior. Change the position of the sliding sunroof or open a side window slightly to reduce or eliminate these noises.

**Sliding sunroof reversing feature**

The sliding sunroof is equipped with an automatic reversing feature. If a solid object blocks or restricts the sliding sunroof during the closing process, the sliding sunroof opens again automatically. The automatic reversing feature is only an aid and is no substitute for your attention when closing the sliding roof.

**⚠ WARNING**

The reversing feature does not react:

- to soft, light and thin objects, e.g. small fingers
- over the last 1/6 in (4 mm) of the closing movement
- during resetting
- when closing the sliding sunroof again manually immediately after automatic reversing

This means that the reversing feature cannot prevent someone being trapped in these situations. There is a risk of injury.

Make sure that no body parts are in close proximity during the closing procedure.

If somebody becomes trapped:

- release the switch immediately, or
- press the switch in any direction during the automatic closing process

The closing process is stopped.

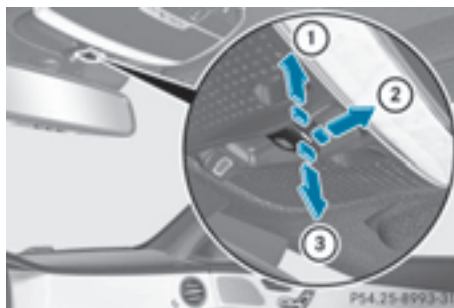
**Operating the sliding sunroof****Opening and closing**

- ① To raise
- ② To open
- ③ To close/lower

► Turn the SmartKey to position **1** or **2** in the ignition lock.

► Press or pull the  switch in the corresponding direction.

If you press or pull the  switch beyond the point of resistance, automatic operation is started in the corresponding direction. You can stop

automatic operation by pressing or pulling again.

If the sliding sunroof is raised at the rear, it lowers slightly automatically at higher speeds. The noise level in the vehicle interior is reduced as a result.

At low speeds it raises again automatically.

You can also temporarily deactivate automatic lowering. To do so, press the  switch. The sliding sunroof raises again automatically.

You can continue to operate the sliding sunroof after switching off the engine or removing the SmartKey from the ignition lock. This function remains active for five minutes or until you open a front door.

The sliding sunroof cannot be opened if a roof carrier is installed. In order to allow ventilation of the vehicle interior, you can raise the sliding sunroof.

If contact is made with a roof carrier approved by Mercedes-Benz, the sliding sunroof lowers slightly but remains raised at the rear.

Before opening, raising or closing the sliding sunroof, a check is carried out to see whether a valid SmartKey is in the vehicle, if:

- the  switch is pressed or pulled and
- the Start/Stop button is used instead of the SmartKey in the ignition lock and
- the engine is not running

This is carried out by means of a brief radio connection between the vehicle and the SmartKey.

### Rain-closing feature

The raised sliding sunroof automatically lowers at the rear when driving if it starts to rain. The sliding sunroof is lowered depending on:

- the road speed and
- the intensity of the rain

You can manually cancel the automatic closing procedure. Press or pull the  switch in any direction.

To raise the sliding sunroof again, press the  switch in direction ①. The rain-closing feature remains activated.

### Operating the roller sunblinds for the sliding sunroof

#### Important safety notes

##### WARNING

Parts of the body could become trapped between the roller sunblind and frame or sliding sunroof during automatic opening or closing. There is a risk of injury.

When opening or closing, make sure that no body parts are in the sweep of the roller sunblind.

If somebody becomes trapped:

- release the switch immediately, or
- during automatic operation, push the switch briefly in any direction

The opening or closing procedure will be stopped.

The roller sunblinds shield the vehicle interior from sunlight. The front roller sunblind can only be opened and closed when the sliding sunroof is closed.

### Roller sunblind reversing feature

The roller sunblinds are equipped with an automatic reversing feature. If a solid object blocks or restricts a roller sunblind during the closing process, the roller sunblind opens again automatically. The automatic reversing feature is only an aid and is not a substitute for your attention when closing the roller sunblinds.

##### WARNING

The reversing feature does not react in particular to soft, light and thin objects, e.g. small fingers. This means that the reversing feature cannot prevent someone being trapped in these situations. There is a risk of injury.

When closing the roller sunblind, make sure that no body parts are in the sweep area.

If somebody becomes trapped:



- release the switch immediately, or
- press the switch in any direction during the automatic closing process

The closing process is stopped.

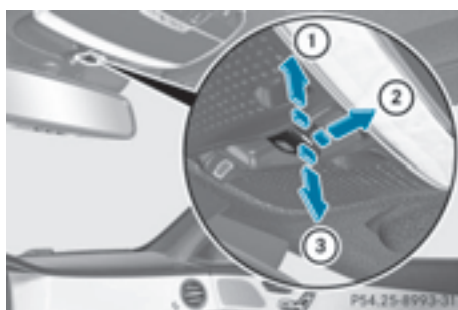
## Opening and closing the front roller sunblind



The front roller sunblind can only be closed when the sliding sunroof is closed.

- ▶ Turn the SmartKey to position **1** or **2** in the ignition lock.
- ▶ Press the  switch in direction **①**.  
The front roller sunblind opens, then the sliding roof is raised.
- ▶ Pull the  switch in direction **②**.  
The front roller sunblind opens.
- ▶ Pull the  switch in direction **③**.  
The front roller sunblind closes if the sliding sunroof is closed.

If you press or pull the  switch beyond the point of resistance, automatic operation is started in the corresponding direction. You can stop automatic operation by pressing or pulling again.

## Opening and closing the rear roller sunblind

### Operating from the front

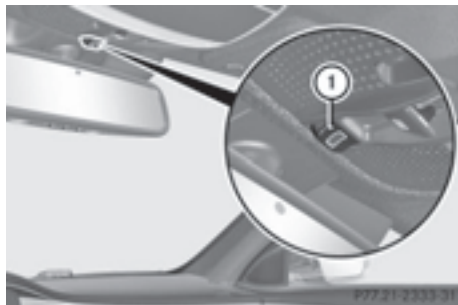

**Vehicles without MAGIC SKY CONTROL:** you can operate the rear roller sunblind from the front.

- ▶ **To open or close:** press button **①**.  
The rear roller sunblind opens or closes fully.
- ▶ **To stop:** press button **①** again.

You must first open or close the rear roller sunblind fully before you can move it in the other direction.

### Operating from the rear compartment

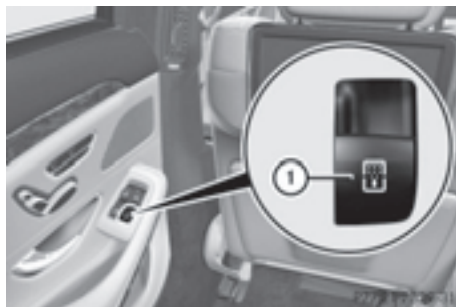

- ▶ **To open/close manually:** press or pull switch **①** to the point of resistance and hold it until the rear roller sunblind has reached the desired position.
- ▶ **To open/close fully:** press or pull switch **①** beyond the point of resistance and release it.

If you press switch **①** again when the rear roller sunblind is fully opened, the degree of transparency of the rear MAGIC SKY CONTROL element changes. If you pull switch **①** again when the rear roller sunblind is fully closed, the degree of transparency changes only when the roller sunblind is opened (▷ page 100).

If the rear roller sunblind closes when the rear MAGIC SKY CONTROL element is not tinted, this tints automatically.

## MAGIC SKY CONTROL

### General notes

MAGIC SKY CONTROL is a panorama roof, the transparency of which can be changed by applying electrical voltage.

MAGIC SKY CONTROL can be switched between darkened and transparent states.

MAGIC SKY CONTROL darkens automatically after a short period when you turn the SmartKey to position **0** or remove the SmartKey.

### Risk of electric shock

#### DANGER

MAGIC SKY CONTROL operates using high voltage. If the headliner is damaged or removed, electrical components will be exposed. If you touch these components, you could get an electric shock. There is a risk of fatal injury.

- Never remove the headliner.
- If the headliner is damaged, never touch the electrical components behind it.
- Always have work on the MAGIC SKY CONTROL carried out at a qualified specialist workshop.

The high-voltage components of MAGIC SKY CONTROL are protected behind the headliner. These are in the hidden portion of the movable roof element of the panorama roof with power tilt/sliding panel and above the left rear door. The MAGIC SKY CONTROL voltage transformer is stamped with a high-voltage symbol, warning you about the high voltage. The electric cables of the high-voltage section are color orange.

### Operating MAGIC SKY CONTROL from the front





- ▶ Turn the SmartKey to position **1** or **2** in the ignition lock. MAGIC SKY CONTROL switches to the status it was set to before the engine was switched off.
- ▶ **To change the degree of transparency:** press button .

If the rear MAGIC SKY CONTROL element is in a different state than the front element, the degree of transparency will change only in the front element. Both elements will then be in the same state and any further changes will again occur synchronously.

At sub-zero temperatures, the change is slower and uneven. The entire process may take some time.

### Operating the rear MAGIC SKY CONTROL element from the rear



- ▶ **To change the degree of transparency when the roller sunblind is fully opened:** press switch .
- ▶ **To change the degree of transparency when the roller sunblind is fully closed:** pull switch .

The degree of transparency will change only after the roller sunblind is opened.





If the rear roller sunblind closes when the rear MAGIC SKY CONTROL element is not tinted, this tints automatically.

### Resetting the sliding sunroof and the roller sunblind

#### Resetting the sliding sunroof or the front roller sunblinds



Reset the sliding sunroof or the front roller sunblind if the sliding sunroof or the front roller sunblind does not move smoothly.

- ▶ Turn the SmartKey to position **1** or **2** in the ignition lock.
- ▶ Pull the  switch to the point of resistance in the direction of arrow ① until the sliding sunroof is fully closed.
- ▶ Keep the  switch pulled for an additional second.
- ▶ Pull the  switch in the direction of arrow ① until the front roller sunblind is closed.
- ▶ Keep the  switch pulled for an additional second.
- ▶ Make sure that the sliding sunroof and the front roller sunblind can be fully opened again.
- ▶ If this is not the case, repeat the steps above again.

### Resetting the rear sunblind



- ▶ Turn the SmartKey to position **1** or **2** in the ignition lock.
- ▶ Pull switch ① repeatedly until the rear roller sunblind is fully closed.
- ▶ Keep switch ① pulled for an additional second.
- ▶ Make sure that the rear roller sunblind can be opened fully again.
- ▶ If this is not the case, repeat the steps above again.



**Problems with the sliding sunroof****⚠ WARNING**

If you close the sliding sunroof again immediately after it has been blocked or reset, the sliding sunroof closes with increased or maximum force. The reversing feature is then not active. Parts of the body could be trapped in the closing area in the process. This poses an increased risk of injury or even fatal injury.



Make sure that no parts of the body are in the closing area.

If somebody becomes trapped:

- release the switch immediately, or
- press the switch in any direction during the automatic closing process

The closing process is stopped.

**!** If the sliding sunroof still cannot be opened or closed as a result of a malfunction, contact a qualified specialist workshop.

Problem	Possible causes/consequences and ► Solutions
<p>The sliding sunroof cannot be closed and you cannot see the cause.</p>	<p>If the sliding sunroof is obstructed during closing and reopens again slightly:</p> <ul style="list-style-type: none"> <li>► Immediately after it blocks, pull the  switch down again to the point of resistance until the sliding sunroof is closed. The sliding sunroof is closed with increased force.</li> </ul> <p>If the sliding sunroof is obstructed again during closing and then reopens slightly:</p> <ul style="list-style-type: none"> <li>► Immediately after it blocks, pull the  switch down again to the point of resistance until the sliding sunroof is closed. The sliding sunroof is closed without the automatic reversing feature.</li> </ul>

## Useful information

- i** This Operator's Manual describes all models and all standard and optional equipment of your vehicle available at the time of publication of the Operator's Manual. Country-specific differences are possible. Please note that your vehicle may not be equipped with all features described. This also applies to safety-related systems and functions.
- i** Read the information on qualified specialist workshops (> page 28).

## Correct driver's seat position

**⚠ WARNING**

You could lose control of your vehicle if you do the following while driving:

- adjust the driver's seat, head restraint, steering wheel or mirrors
- fasten the seat belt

There is a risk of an accident.

Adjust the driver's seat, head restraint, steering wheel and mirror and fasten your seat belt before starting the engine.



- ▶ Observe the safety guidelines on seat adjustment (> page 105).
- ▶ Check whether you have adjusted seat ③ properly (> page 106).

When adjusting the seat, make sure that:

- you are as far away from the driver's air bag as possible
  - you are sitting in a normal upright position
  - you can fasten the seat belt properly
  - you have moved the backrest to an almost vertical position
  - you have set the seat cushion angle so that your thighs are gently supported
  - you can depress the pedals properly
- ▶ Check whether the head restraint is adjusted properly.

When doing so, make sure that you have adjusted the head restraint so that the back of your head is supported at eye level by the center of the head restraint.

- ▶ Observe the safety guidelines on steering wheel adjustment (> page 120).
- ▶ Make sure that steering wheel ① is adjusted properly (> page 120).

When adjusting the steering wheel, make sure that:

- you can hold the steering wheel with your arms slightly bent
  - you can move your legs freely
  - you can see all the displays in the instrument cluster clearly
- ▶ Observe the safety guidelines for seat belts (> page 47).
- ▶ Check whether you have fastened seat belt ② properly (> page 49).

The seat belt should:

- fit snugly across your body
  - be routed across the middle of your shoulder
  - be routed in your pelvic area across the hip joints
- ▶ Before starting off, adjust the rear-view mirror and the exterior mirrors in such a way that you have a good view of road and traffic conditions (> page 123).
- ▶ **Vehicles with a memory function:** save the seat, steering wheel and exterior mirror settings with the memory function (> page 126).

## Seats

## Important safety notes

 WARNING

Children could become trapped if they adjust the seats, particularly when unattended.

There is a risk of injury.

When leaving the vehicle, always take the SmartKey with you and lock the vehicle. Never leave children unsupervised in the vehicle.

The seats can still be adjusted when there is no SmartKey in the ignition lock.

 WARNING

When you adjust a seat, you or other vehicle occupants could become trapped, e.g. on the seat guide rail. There is a risk of injury.

Make sure when adjusting a seat that no one has any body parts in the sweep of the seat.

Observe the safety notes on "Air bags" (▷ page 50) and "Children in the Vehicle" (▷ page 61).

 WARNING

You could lose control of your vehicle if you do the following while driving:

- adjust the driver's seat, head restraint, steering wheel or mirrors
- fasten the seat belt

There is a risk of an accident.

Adjust the driver's seat, head restraint, steering wheel and mirror and fasten your seat belt before starting the engine.

 WARNING

If you adjust the seat height carelessly, you or other vehicle occupants could be trapped and thereby injured. Children in particular could accidentally press the electrical seat adjustment buttons and become trapped. There is a risk of injury.

While moving the seats, make sure that your hands or other body parts do not get under the lever assembly of the seat adjustment system.

 WARNING

If the head restraints are not installed or not adjusted correctly, they cannot provide protection as intended. There is an increased risk of injury in the head and neck area, e.g. in the event of an accident or when braking.

Always drive with the head restraints installed. Before driving off, make sure for every vehicle occupant that the center of the head restraint supports the back of the head at about eye level.

 WARNING

The seat belt does not offer the intended level of protection if you have not moved the backrest to an almost vertical position. When braking or in the event of an accident, you could slide underneath the seat belt and sustain abdomen or neck injuries, for example. This poses an increased risk of injury or even fatal injury.

Adjust the seat properly before beginning your journey. Always ensure that the backrest is in an almost vertical position and that the shoulder section of your seat belt is routed across the center of your shoulder.

 To avoid damage to the seats and the seat heating, observe the following information:

- keep liquids from spilling on the seats. If liquid is spilled on the seats, dry them as soon as possible.
- if the seat covers are damp or wet, do not switch on the seat heating. The seat heating should also not be used to dry the seats.
- clean the seat covers as recommended; see "Interior care".
- do not transport heavy loads on the seats. Do not place sharp objects on the seat cushions, e.g. knives, nails or tools. The seats should only be occupied by passengers, if possible.
- when the seat heating is in operation, do not cover the seats with insulating materials, e.g. blankets, coats, bags, seat covers, child seats or booster seats.

 Make sure that there are no objects in the footwell under or behind the seats when mov-

ing the seats back. There is a risk that the seats and/or the objects could be damaged.

### Adjusting the seats

#### Vehicles with standard head restraints or luxury head restraints

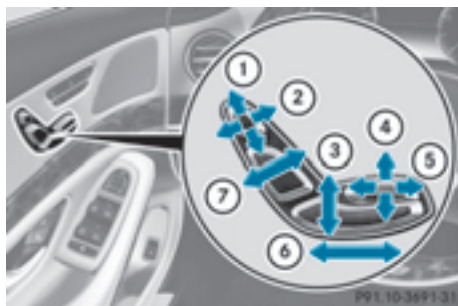

- ① Head restraint height
- ② Head restraint height
- ③ Seat height
- ④ Seat cushion angle
- ⑤ Seat cushion length
- ⑥ Seat fore-and-aft adjustment
- ⑦ Backrest angle

- i** If PRE-SAFE® is triggered, the front-passenger seat will be moved to a better position if it was previously in an unfavorable position (▷ page 59).
- i** You can store the seat settings using the memory function (▷ page 126).
- i** To ensure the largest possible range of seat settings, certain seat adjustment functions will automatically activate other seat adjustment functions.
- i** The head restraint height is adjusted automatically when you adjust the seat height or the seat fore-and-aft position.

#### Vehicles with an EASY ADJUST luxury head restraint

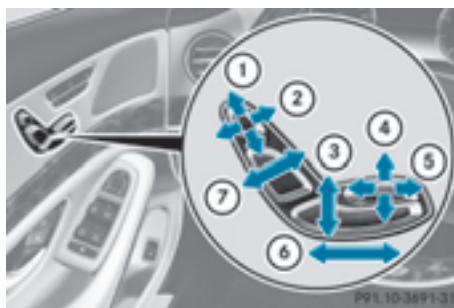

- ① Head restraint height
- ② Head restraint fore-and-aft position
- ③ Seat height
- ④ Seat cushion angle
- ⑤ Seat cushion length
- ⑥ Seat fore-and-aft adjustment
- ⑦ Backrest angle

- i** If PRE-SAFE® is triggered, the front-passenger seat will be moved to a better position if it was previously in an unfavorable position (▷ page 59).
- i** You can store the seat settings using the memory function (▷ page 126).
- i** To ensure the largest possible range of seat settings, certain seat adjustment functions will automatically activate other seat adjustment functions.
- i** The head restraint height is adjusted automatically when you adjust the seat height or the seat fore-and-aft position.
- i** The fore-and-aft position of the head restraint is adjusted automatically when you adjust the backrest.

## Adjusting the rear seat

### Adjusting the rear seat

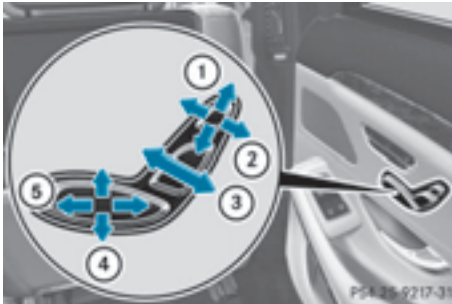

- ① Head restraint height
- ② Head restraint fore-and-aft position
- ③ Backrest angle
- ④ Combined seat cushion angle and length
- ⑤ Combined seat cushion angle and length

You can only adjust the outer seats in the rear electrically.

### Adjusting a rear reclining seat

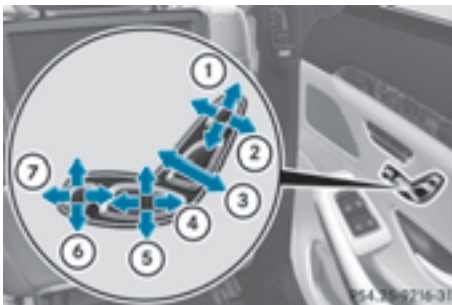

- ① Head restraint height
- ② Head restraint fore-and-aft position
- ③ Backrest angle
- ④ Combined seat cushion angle and length
- ⑤ Combined seat cushion angle and length
- ⑥ Legrest angle
- ⑦ Legrest length

The rear reclining seat is only available in long wheelbase vehicles equipped with "executive seats". On vehicles without a rear reclining seat the button for setting the angle and length of the legrest has no function.

Vehicles with a long wheelbase: depending on the vehicle equipment, the rear reclining seat is

either only on the front-passenger side or also on the driver's side.

Mercedes-Maybach vehicles: the rear reclining seat is on the driver's and the front-passenger side.

Vehicles with a long wheelbase and equipped with a "Rear compartment chauffeur / memory package" also have a footrest. This is located on the lower part of the front-passenger seat backrest (▷ page 108).

The legrest folds down if overloaded. If this is the case fold up the legrest and engage it.

### Setting the reclined position



This function is only available with long wheelbase vehicles.

You can use the override button to disable this function (▷ page 67).

The SmartKey must be in the ignition lock and in position **1** or **2**, before the rear seat can be moved into the reclined position (▷ page 162).

- ▶ Press and hold button **①** until the seat has reached the reclined position.

The rear seat moves into the reclined position, the front-passenger seat moves into the chauffeur position (▷ page 111). The footrest moves out from under the front-passenger seat.

You can exit the reclined position and adjust the seat position by:

- calling up a stored position using memory buttons **1** or **2** (▷ page 127)
- manually adjusting the seat to the desired position (▷ page 106)

- i** The steps for setting the reclined position are not always carried out simultaneously.

The legrest folds down if overloaded. If this is the case fold up the legrest and engage it.

## Adjusting the front-passenger seat from the driver's seat

### Important safety notes

#### WARNING

When you adjust a seat, you or other vehicle occupants could become trapped, e.g. on the seat guide rail. There is a risk of injury.

Make sure when adjusting a seat that no one has any body parts in the sweep of the seat.

Observe the safety notes on "Air bags" (▷ page 50) and "Children in the vehicle" (▷ page 61).

#### WARNING

The front-air bags for could also injure the vehicle occupants in the front if the front seats are positioned too close to the dashboard or steering wheel. This poses an increased risk of injury or even fatal injury.

Always adjust the front seats so that they are as far from the front air bags as possible. Also observe the notes on the correct adjustment of the seats.

#### WARNING

Children could become trapped if they adjust the seats, particularly when unattended. There is a risk of injury.

When leaving the vehicle, always take the SmartKey with you and lock the vehicle. Never leave children unsupervised in the vehicle.

**!** Do not move the front-passenger seat fully forwards if there are objects in the parcel net in the front-passenger footwell. The objects could otherwise be damaged.

## Adjusting the front-passenger seat



The SmartKey must be in the ignition lock and in position **1** or **2**, in order for the front-passenger seat to be selected (▷ page 162).

► **To select the front-passenger seat:** press button **1** repeatedly until the indicator lamp in the button lights up.

When the indicator lamp in button **1** lights up, for the front-passenger seat you can adjust:

- adjust the seat (▷ page 106)
- seat heating (▷ page 118)
- seat ventilation (▷ page 119)
- the memory function to call up or save settings (▷ page 126).

## Adjusting the front-passenger seat from the rear

### Important safety notes

#### WARNING

Children could become trapped if they adjust the seats, particularly when unattended. There is a risk of injury.

When leaving the vehicle, always take the SmartKey with you and lock the vehicle. Never leave children unsupervised in the vehicle.

The seats can still be adjusted when there is no SmartKey in the ignition lock.

#### WARNING

When you adjust a seat, you or other vehicle occupants could become trapped, e.g. on the seat guide rail. There is a risk of injury.

Make sure when adjusting a seat that no one has any body parts in the sweep of the seat.

Observe the safety notes on "Air bags" (▷ page 50) and "Children in the vehicle" (▷ page 61).

**⚠ WARNING**

The front-air bags for could also injure the vehicle occupants in the front If the front seats are positioned too close to the dash-board or steering wheel. This poses an increased risk of injury or even fatal injury.

Always adjust the front seats so that they are as far from the front air bags as possible. Also observe the notes on the correct adjustment of the seats.

**!** Do not move the front-passenger seat fully forwards if there are objects in the parcel net in the front-passenger footwell. The objects could otherwise be damaged.

**i** You can use the rear-compartment override button to disable the setting of the front-passenger seat from the rear (▷ page 67).

**Adjusting the rear seat**

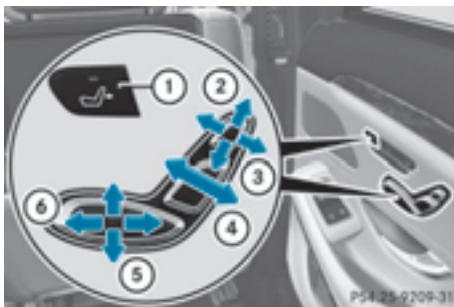

- ① Selects rear-compartment seat
- ② Head restraint height
- ③ Head restraint fore-and-aft position
- ④ Backrest angle
- ⑤ Combined seat cushion angle and length
- ⑥ Combined seat cushion angle and length

► **To select the rear seat:** press button ① repeatedly until the indicator lamp in the button is not lit.

The rear-compartment seat is selected if the indicator lamp in the button is not lit.

► Adjust the rear seats with buttons ② to ⑥.

**Adjusting the front-passenger seat**

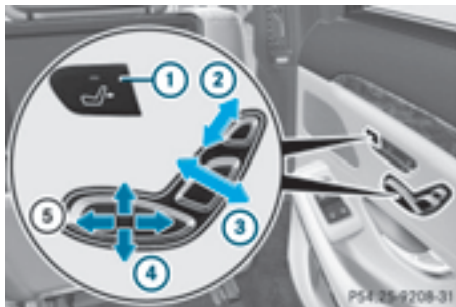

① Selects the front-passenger seat

② Head restraint height

③ Backrest angle

④ Seat height

⑤ Seat fore-and-aft adjustment

The SmartKey must be in the ignition lock and in position 1 or 2, in order for the front-passenger seat to be selected (▷ page 162).

► **To select the front-passenger seat:** press button ① repeatedly until the indicator lamp in the button lights up.

The front-passenger seat is selected if the indicator lamp in the button lights up.

► Adjust the front-passenger seat with buttons ② to ⑤.

### Adjusting the rear seat on vehicles with EASY ADJUST luxury head restraints

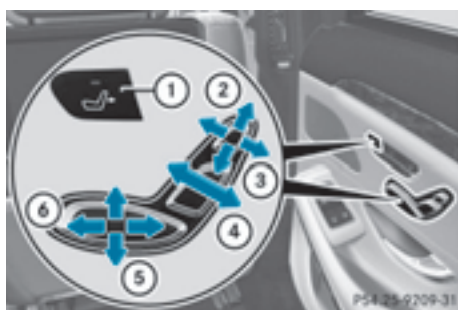

- ① Selects rear-compartment seat
- ② Head restraint height
- ③ Head restraint fore-and-aft position
- ④ Backrest angle
- ⑤ Combined seat cushion angle and length
- ⑥ Combined seat cushion angle and length

► **To select the rear seat:** press button ① repeatedly until the indicator lamp in the button is not lit.

The rear-compartment seat is selected if the indicator lamp in the button is not lit.

► Adjust the rear seat with buttons ② to ⑥.

### Adjusting the front-passenger seat on vehicles with EASY ADJUST luxury head restraints

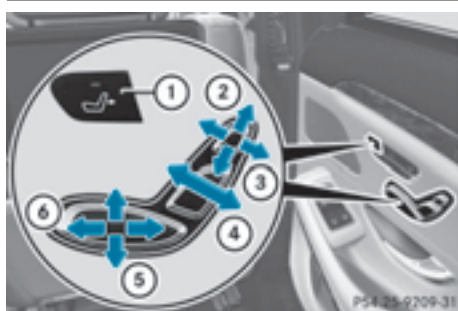

- ① Selects the front-passenger seat
- ② Head restraint height
- ③ Head restraint fore-and-aft position
- ④ Backrest angle
- ⑤ Seat height
- ⑥ Seat fore-and-aft adjustment

The SmartKey must be in the ignition lock and in position 1 or 2, in order for the front-passenger seat to be selected (► page 162).

► **To select the front-passenger seat:** press button ① repeatedly until the indicator lamp in the button lights up.

The front-passenger seat is selected if the indicator lamp in the button lights up.

► Adjust the front-passenger seat with buttons ② to ⑥.

EASY ADJUST luxury head restraints are available individually on vehicles equipped with a rear compartment chauffeur/memory package.

### Vehicles with seat for chauffeur mode and long wheelbase

#### Adjusting the rear seat

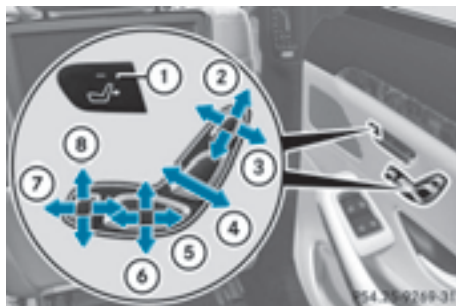

- ① Selects rear-compartment seat
- ② Head restraint height
- ③ Head restraint fore-and-aft position
- ④ Backrest angle
- ⑤ Combined seat cushion angle and length
- ⑥ Combined seat cushion angle and length
- ⑦ Longitudinal direction of the legrest if rear reclining seat is installed
- ⑧ Angle of the legrest if rear reclining seat is installed

► **To select the rear seat:** press button ① repeatedly until the indicator lamp in the button is not lit.

The rear-compartment seat is selected if the indicator lamp in the button is not lit.

► Adjust the rear seats with buttons ② to ⑧.



## Adjusting the front-passenger seat

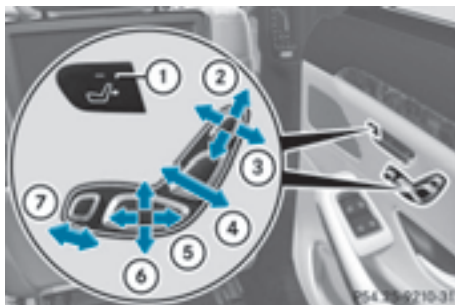

- ① Selects the front-passenger seat
- ② Head restraint height
- ③ Head restraint fore-and-aft position
- ④ Backrest angle
- ⑤ Seat fore-and-aft adjustment
- ⑥ Seat height
- ⑦ Footrest

The SmartKey must be in the ignition lock and in position **1** or **2**, in order for the front-passenger seat to be selected (▷ page 162).

► **To select the front-passenger seat:** press button ① repeatedly until the indicator lamp in the button lights up.

The front-passenger seat is selected if the indicator lamp in the button lights up.

► Adjust the front-passenger seat with buttons ② to ⑦.

The footrest can only be adjusted if:

- the front-passenger seat is moved fully forward
- the front-passenger seat is in the position for chauffeur mode (▷ page 111).

**i** The front-passenger seat in the Mercedes-Maybach must not be positioned fully forwards when adjusting the footrest. The front-passenger seat must be moved forwards from the rear to the middle adjustment range.

### Chauffeur mode

#### Important safety notes

##### WARNING

If the head restraints are not installed or not adjusted correctly, they cannot provide protection as intended. There is an increased risk

of injury in the head and neck area, e.g. in the event of an accident or when braking.

Always drive with the head restraints installed. Before driving off, make sure for every vehicle occupant that the center of the head restraint supports the back of the head at about eye level.

##### WARNING

If the front-passenger seat is in chauffeur mode and the front-passenger head restraint is folded down, the view of the passenger-side exterior mirror can be impaired. There is a risk of an accident.

To have a free view of the exterior mirror, remove the front-passenger head restraint.

**!** Make sure that there are no objects in the footwell under or behind the seats when moving the seats back. There is a risk that the seats and/or the objects could be damaged.

#### General notes

In chauffeur mode:

- the front-passenger seat is moved forwards
- the backrest is tilted forwards
- the head restraint is folded forwards

The front-passenger seat automatically moves from the chauffeur position back into the normal position if:

- the front-passenger seat is adjusted using the seat adjustment switch on the front-passenger door
- the front-passenger seat belt is fastened
- an occupant is detected on the front-passenger seat
- the front-passenger seat head restraint is inserted and the ignition is switched on
- the front-passenger seat backrest is moved backwards or the seat is moved in a longitudinal direction out of the chauffeur area (▷ page 113)

## Positioning the front-passenger seat for chauffeur mode

### General notes

Pay attention to the important safety notes (▷ page 111). Adjust the seat for chauffeur mode before the journey (▷ page 112). Do not remove the front-passenger seat head restraint during the journey.

### Adjusting from the rear compartment

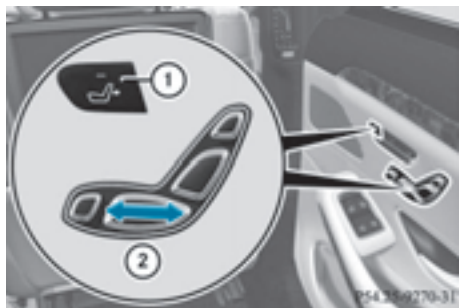

You can use the override button to disable this function (▷ page 67).

In order for the front-passenger seat to be positioned in chauffeur mode:

- the SmartKey must be in the ignition lock and in position **1** or **2** (▷ page 162)
- the front-passenger seat may not be occupied
- the front-passenger seat belt must not be inserted into the buckle
- ▶ **To select the front-passenger seat:** press button **1** repeatedly until the indicator lamp in the button lights up.  
The front-passenger seat is selected if the indicator lamp in the button lights up.
- ▶ Press button **2** forwards and hold it in this position.  
The seat moves forward.  
The seat stops at the threshold of the area for chauffeur mode.
- ▶ Release button **2**.
- ▶ Press and hold button **2** again until the front-passenger seat is in position for chauffeur mode.  
The head restraint on the front-passenger seat folds forwards. The seat moves forward.  
The **To view the ext. mirror, adjust front-passenger seat or remove the**

**head restraint.** message appears in the multifunction display (▷ page 310).

- i** If the front-passenger seat is already at the threshold to the area for the chauffeur mode, the position for the chauffeur mode is set immediately.
- i** The position for chauffeur mode can be saved or set using the memory function of the rear seat (▷ page 127). For this the indicator lamp on button **1** must be lit.

### Adjusting from the driver's seat

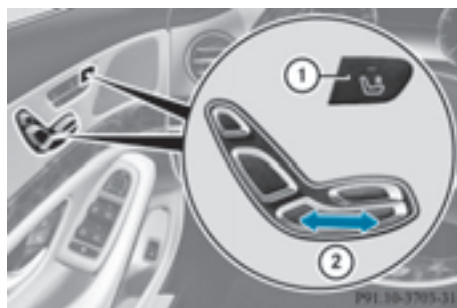

In order for the front-passenger seat to be positioned in chauffeur mode:

- the SmartKey must be in the ignition lock and in position **1** or **2** (▷ page 162)
- the front-passenger seat may not be occupied
- the front-passenger seat belt must not be inserted into the buckle
- ▶ **To select the front-passenger seat:** press button **1** repeatedly until the indicator lamp in the button lights up.  
The front-passenger seat is selected if the indicator lamp in the button lights up.
- ▶ Press button **2** forward and hold it.  
The seat moves forward.  
The seat stops at the threshold of the area for chauffeur mode.
- ▶ Release button **2**.
- ▶ Press and hold button **2** again until the front-passenger seat is in position for chauffeur mode.  
The head restraint on the front-passenger seat folds forwards. The seat moves forward.  
The **To view the ext. mirror, adjust front-passenger seat or remove the head restraint.** (▷ page 310) message appears in the multifunction display.

- i** If the front-passenger seat is already at the threshold to the area for the chauffeur mode, the position for the chauffeur mode is set immediately.
- i** The position for chauffeur mode cannot be stored or set with the driver's seat memory function.

## Installing/removing the head restraint

### Removing

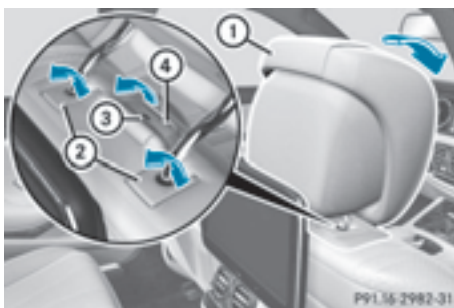

- ▶ Move the seat into the position for chauffeur mode, until the head restraint folds forward completely (▶ page 112).
- ▶ Fold head restraint bar covers ② backwards.
- ▶ Pull adjuster lever ④ backwards and hold it in this position. Hold head restraint ① while doing so.
- ▶ Remove head restraint ①.
- ▶ Release adjuster lever ④. Red pin ③ protrudes from the adjuster lever.
- ▶ Press down red pin ③.
- ▶ Fold covers ② forwards and close them.

### Installing

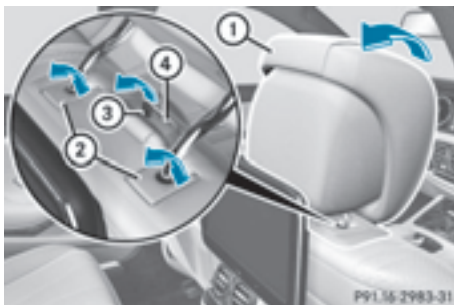

- ▶ Fold covers ② backwards.
- ▶ Pull handle ④ backwards. Red pin ③ protrudes from the adjuster lever.
- ▶ Insert head restraint ① into the brackets. The head restraint must engage on both sides.
- ▶ Press down red pin ③. If the pin can be pressed down and is then no longer visible, the head restraint has engaged correctly.
- ▶ Fold covers ② forwards and close them. The head restraint folds into position automatically.

## Moving the front-passenger seat into the normal position

### Adjusting from the rear compartment

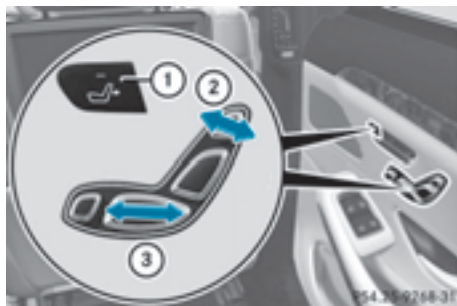

You can use the override button to disable this function (▶ page 67).

The head restraint must be installed, in order for the front-passenger seat to be moved into the normal position (▶ page 113).

The SmartKey must be in the ignition lock and in position 1 or 2, in order for the front-passenger seat to be selected (▶ page 162).

- ▶ **To select the front-passenger seat:** press button ① repeatedly until the indicator lamp in the button lights up. The front-passenger seat is selected if the indicator lamp in the button lights up.
- ▶ Press button ③ backwards and hold it in this position. The front-passenger seat moves into the normal adjustment range at the threshold of the area for chauffeur mode. The head restraint folds into position. If you continue to hold down button ③, the seat continues to move backwards.

or

- ▶ Briefly press button ② backwards. The front-passenger seat moves into the normal adjustment range at the threshold to the area for chauffeur mode. The head restraint folds into position.

**i** Further settings are available via the memory adjustment buttons, if:

- a position in the normal setting has already been saved
- the front-passenger seat has been selected with button ①

### Adjusting from the driver's seat

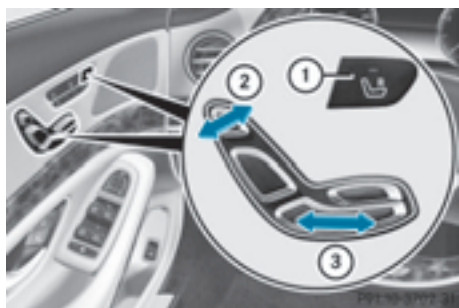

The head restraint must be installed, in order for the front-passenger seat to be moved into the normal position (▷ page 113).

The SmartKey must be in the ignition lock and in position 1 or 2, in order for the front-passenger seat to be selected (▷ page 162).

- ▶ **To select the front-passenger seat:** press button ① repeatedly until the indicator lamp in the button lights up. The front-passenger seat is selected if the indicator lamp in the button lights up.
- ▶ Press button ③ backwards and hold it in this position. The front-passenger seat moves into the normal adjustment range at the threshold of the area for chauffeur mode. The head restraint folds into position. If you continue to hold down button ③, the seat continues to move backwards.

or

- ▶ Briefly press button ② backwards. The front-passenger seat moves into the normal adjustment range at the threshold to the area for chauffeur mode. The head restraint folds into position.

**i** Further settings are available via the memory adjustment buttons if the front-passenger seat has been selected with button ①.

### Adjusting from the front-passenger seat

- ▶ Press any seat adjustment button. The front-passenger seat moves into the normal adjustment range at the threshold of the area for chauffeur mode. The head restraint folds into position.

### Fully reclined position of the front-passenger seat

#### Setting

This function is only available on vehicles with electrically adjustable rear seats.

You can move the front-passenger seat into a fully reclined position. The rear seat and front-passenger seat then provide a continuous surface.

To do so:

- move the seat cushion of the rear seat as far back as possible in a longitudinal direction (▷ page 107)
- move the front-passenger seat into position for chauffeur mode (▷ page 112)
- remove the front-passenger seat head restraint (▷ page 113)
- move the front-passenger seat so that the backrest is in a fully reclined position (▷ page 106)

#### Exiting

To exit the fully reclined position:

- fold the backrest upright to a suitable position
- install the head restraint (▷ page 113)

### Adjusting the head restraints

#### Important safety notes

##### **WARNING**

You could lose control of your vehicle if you do the following while driving:

- adjust the driver's seat, head restraint, steering wheel or mirrors
- fasten the seat belt

There is a risk of an accident.  
Adjust the driver's seat, head restraint, steering wheel and mirror and fasten your seat belt before starting the engine.

**⚠ WARNING**

If the head restraints are not installed or not adjusted correctly, they cannot provide protection as intended. There is an increased risk of injury in the head and neck area, e.g. in the event of an accident or when braking.

Always drive with the head restraints installed. Before driving off, make sure for every vehicle occupant that the center of the head restraint supports the back of the head at about eye level.

**General notes**

Pay attention to the important safety notes (▷ page 105).

Do not rotate the head restraints of the front and rear seats. Otherwise, you cannot adjust the height and angle of the head restraints to the correct position.

**Adjusting the front head restraints**

**Adjusting the head restraints manually**



With this function you can adjust the distance between the head restraint and the back of the seat occupant's head.

- ▶ **To move forwards:** pull the head restraint forwards in the direction of the arrow until it engages in the desired position.
- ▶ **To move backwards:** press and hold release button ①.

- ▶ Push the head restraint back.
- ▶ Release the release button once the head restraint is in the desired position.
- ▶ Ensure that the head restraint has engaged properly.

**Adjusting the luxury head restraint mechanically**

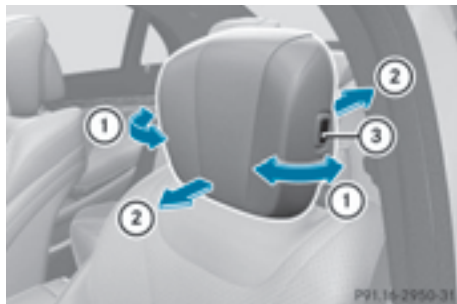

- ▶ **To adjust the side bolsters of the head restraint:** push or pull right and/or left-hand side bolster ① into the desired position.
- ▶ **To adjust the fore-and-aft position forwards:** pull the head restraint forwards in the direction of arrow ② until it engages in the desired position.
- ▶ **To adjust the fore-and-aft position backwards:** press and hold release button ③.
- ▶ Fold the head restraint backwards in the direction of arrow ②.
- ▶ Let go of release button ③ once the head restraint is in the desired position.
- ▶ Ensure that the head restraint has engaged properly.

**Adjusting the EASY ADJUST luxury head restraint mechanically**

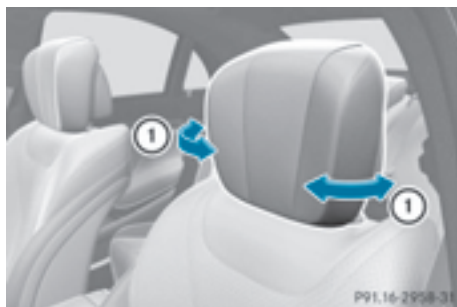

- ▶ **To adjust the side bolsters of the head restraint:** push or pull right and/or left-hand side bolster ① into the desired position.

**i** The fore-and-aft position of the head restraint is adjusted automatically when you adjust the seat backrest angle using the seat switch.

### Adjusting the front head restraints electrically

The height and fore-and-aft position of the front head restraints can be adjusted with the seat adjustment switch (▷ page 106).

### Adjusting the rear seat head restraints

#### Lowering the rear seat head restraints electrically from the front



- ▶ Turn the SmartKey to position **1** or **2** in the ignition lock (▷ page 162).
  - ▶ Briefly press button ①. The head restraints lower.
- i** If all of the rear seat head restraints are lowered and button ① is pressed again, the outer rear head restraints move into the last stored position.

#### Extending the outer rear seat head restraints from the front electrically

This function is available on vehicles with electrically adjustable rear seats.

- ▶ Turn the SmartKey to position **1** or **2** in the ignition lock (▷ page 162).
- ▶ Press and hold button ① until the head restraints have extended upwards.

#### Extending the outer rear head restraints into the last stored position

This function is available on vehicles with electrically adjustable rear seats.

- ▶ Turn the SmartKey to position **1** or **2** in the ignition lock (▷ page 162).
- ▶ Briefly press button ①. The head restraints lower.
- ▶ Briefly press button ① again. The head restraints move to the last stored position.

#### Adjusting the luxury head restraint in the rear compartment mechanically

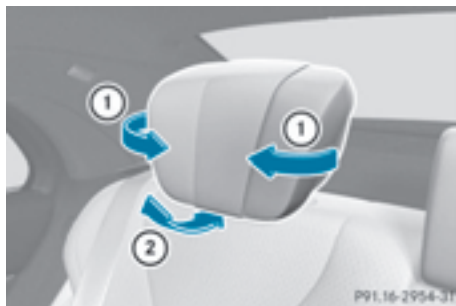

- ▶ **To adjust the side bolsters of the head restraint:** push or pull right and/or left-hand side bolster ① into the desired position.
- ▶ **To adjust the angle of the head restraint:** push or pull the head restraint in the direction of arrow ②.

#### Adjusting the rear head restraints electrically

The height and fore-and-aft position of the rear head restraints can be adjusted with the seat adjustment switch (▷ page 107).

#### Supplementary cushion for luxury head restraints

The supplementary cushion is available on vehicles with electrically adjustable rear seats.

Only use the supplementary cushion when the vehicle is stationary.



The supplementary cushion is located in the vehicle.

The supplementary cushion is attached to the head restraint by three press studs.

Installing the supplementary cushion:

- ▶ Position the head restraint as far forwards as possible (▷ page 107).
- ▶ Hold supplementary cushion ② against the head restraint and push press studs ① into the counterpieces.

Removing the supplementary cushion:

- ▶ Position the head restraint as far forwards as possible (▷ page 107).
- ▶ Release press studs ① and remove supplementary cushion ②.

## Adjusting the rear center head restraints

### Retracting and extending electrically



- ▶ Press and hold button ① until the head restraint has fully extended or retracted.

### Folding into position mechanically



- ▶ Pull the head restraint up until it engages.

### Adjusting the multicontour seat

The settings for the multicontour seat are only activated if:

- the seat is occupied
- the seat belt is fastened

The multicontour seat can be adjusted via the multimedia system (see the separate operating instructions).

### Adjusting the active multicontour seat

The settings for the active multicontour seat are only activated if:

- the seat is occupied
- the seat belt is fastened

**Vehicles installed with the Seat Comfort package:** you can adjust the active multicontour seat for the driver and front passenger via the multimedia system (see the separate operating instructions).

### Multicontour seat in the rear

You can adjust the multicontour seats for the outer seats using the remote control (see the separate operating instructions).

### Adjusting the 4-way lumbar support

The 4-way lumbar support can be adjusted with the multimedia system (see the separate operating instructions).

### Switching the seat heating on/off

#### Switching on/off

#### WARNING

Repeatedly switching on the seat heating can cause the seat cushion and backrest pads to become very hot. The health of persons with limited temperature sensitivity or a limited ability to react to excessively high temperatures may be affected or they may even suffer burn-like injuries. There is a risk of injury.

Therefore, do not switch the seat heating on repeatedly.

For vehicles equipped with the Warmth Comfort package: the armrest in the door and the center console can also be heated when you switch on the seat heating of one of the front seats. You can adjust this using the multimedia system (see the separate operating instructions).

The three red indicator lamps in the button indicate the heating level you have selected.

The system automatically switches down from level **3** to level **2** after approximately eight minutes.

The system automatically switches down from level **2** to level **1** after approximately ten minutes.

The system automatically switches off approximately 20 minutes after it is set to level **1**.

Vehicles with the Seat Heating Plus package: you can set the distribution of the heated sections of the seat cushion and backrest on the front seats via the multimedia system (see the separate operating instructions).

Vehicles with the Seat Heating Plus package: you can adjust the distribution of the heated sections of the seat cushion and backrest on the front seats via the multimedia system (see the separate operating instructions).

Vehicles with Rear Seat Entertainment System and electric seat adjustment: you can set the distribution of the heated sections of the rear seat cushion and backrest via the Rear Seat

Entertainment System (see the separate operating instructions).

### Front seats



- ▶ Turn the SmartKey to position **1** or **2** in the ignition lock (▷ page 162).
- ▶ **To switch on:** press button **1** repeatedly until the desired heating level is set.
- ▶ **To switch off:** press button **1** repeatedly until all the indicator lamps go out.
- i** If the battery voltage is too low, the seat heating may switch off.

### Rear seats



- ▶ Turn the SmartKey to position **1** or **2** in the ignition lock (▷ page 162).
- ▶ **To switch on:** press button **1** repeatedly until the desired heating level is set.
- ▶ **To switch off:** press button **1** repeatedly until all the indicator lamps go out.
- i** If the battery voltage is too low, the seat heating may switch off.



## Problems with the seat heating

Problem	Possible causes/consequences and ► Solutions
The seat heating has switched off prematurely or cannot be switched on.	The on-board voltage is too low because too many electrical consumers are switched on. <ul style="list-style-type: none"> <li>► Switch off electrical consumers that you do not need, such as the rear window defroster or interior lighting. Once the battery is sufficiently charged, the seat heating can be switched back on manually.</li> </ul>

## Switching the seat ventilation on/off

### Front seats



The three blue indicator lamps in the buttons indicate the blower setting you have selected.

- Turn the SmartKey to position **1** or **2** in the ignition lock (► page 162).
- **To switch on:** press button ① repeatedly until the desired blower setting is set.
- **To switch off:** press button ① repeatedly until all the indicator lamps go out.

- i** If the battery voltage is too low, the seat ventilation may switch off.
- i** You can open the side windows and the sliding sunroof using the "Convenience opening" feature (► page 95). The seat ventilation of the driver's seat automatically switches to the highest level.
- i** When the vehicle is stationary, the fan speed can be reduced automatically. This reduces the noises of the seat ventilation.

### Rear seat



Switching the seat ventilation in the rear compartment on/off

- Turn the SmartKey to position **1** or **2** in the ignition lock (► page 162).
- **To switch on:** press button ① repeatedly until the desired blower setting is set.
- **To switch off:** press button ① repeatedly until all the indicator lamps go out.

- i** If the battery voltage is too low, the seat ventilation may switch off.
- i** When the vehicle is stationary, the fan speed can be reduced automatically. This reduces the noises of the seat ventilation.

## Problems with the seat ventilation

Problem	Possible causes/consequences and ► Solutions
The seat ventilation has switched off prematurely or cannot be switched on.	<p>The on-board voltage is too low because too many electrical consumers are switched on.</p> <p>► Switch off electrical consumers that you do not need, such as the rear window defroster or interior lighting.</p> <p>Once the battery is sufficiently charged, the seat ventilation can be switched back on.</p>

## Steering wheel

### Important safety notes

#### WARNING

You could lose control of your vehicle if you do the following while driving:

- adjust the driver's seat, head restraint, steering wheel or mirrors
- fasten the seat belt

There is a risk of an accident.

Adjust the driver's seat, head restraint, steering wheel and mirror and fasten your seat belt before starting the engine.

#### WARNING

Children could injure themselves if they adjust the steering wheel. There is a risk of injury.

When leaving the vehicle, always take the SmartKey with you and lock the vehicle. Never leave children unsupervised in the vehicle.

The electrically adjustable steering wheel can still be adjusted when there is no SmartKey in the ignition lock.

## Adjusting the steering wheel

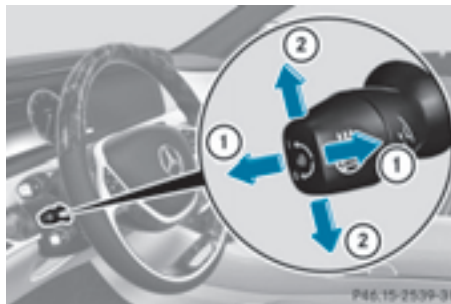

- ① To adjust the steering wheel position (fore-and-aft adjustment)
- ② To adjust the steering wheel height

#### Further related subjects:

- EASY-ENTRY/EXIT feature (► page 122)
- Storing settings (► page 126)
- Operating the on-board computer (► page 257).

## Steering wheel heating

### Switching on/off

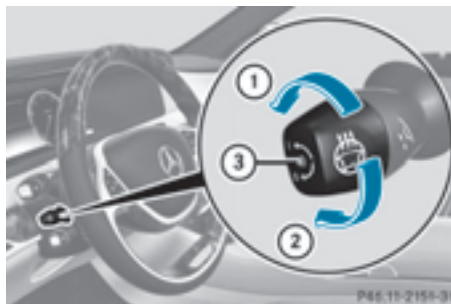

- ▶ Turn the SmartKey to position **2** in the ignition lock (▷ page 162).
- ▶ **To switch on/off:** turn the lever in the direction of arrow ① or ②.  
Indicator lamp ③ lights up or goes out.

If you switch off the ignition, the steering wheel heating is deactivated.

## Problems with the steering wheel heating

Problem	Possible causes/consequences and ► Solutions
The steering wheel heating has switched off prematurely or cannot be switched on.	The on-board voltage is too low because too many electrical consumers are switched on. ► Switch off electrical consumers that you do not need, such as the rear window defroster or interior lighting.

### EASY-ENTRY/EXIT feature

#### Important safety notes

##### WARNING

When the EASY-ENTRY/EXIT feature adjusts the steering wheel and the driver's seat, you and other vehicle occupants – particularly children – could become trapped. There is a risk of injury.

While the EASY-ENTRY/EXIT feature is making adjustments, make sure that no one has any body parts in the sweep of the seat and the steering wheel.

If there is a risk of becoming trapped by

- the steering wheel: move the steering wheel adjustment lever.
- the seat: press the switch for seat adjustment.

The adjustment process is stopped.

Press one of the memory function position switches. The adjustment process is stopped. This function is only available on vehicles with memory function.

##### WARNING

If children activate the EASY-ENTRY/EXIT feature, they can become trapped, particularly when unattended. There is a risk of injury.

When leaving the vehicle, always take the SmartKey with you and lock the vehicle. Never leave children unsupervised in the vehicle.

##### WARNING

If you drive off while the EASY-ENTRY/EXIT feature is making adjustments, you could lose

control of the vehicle. There is a risk of an accident.

Always wait until the adjustment process is complete before driving off.

The EASY-ENTRY/EXIT feature makes getting in and out of your vehicle easier.

You can activate and deactivate the EASY-ENTRY/EXIT feature using the multimedia system (see the separate operating instructions).

#### Position of the steering wheel and the driver's seat when the EASY-ENTRY/EXIT feature is active

The steering wheel tilts upwards and the driver's seat moves backwards if you:

- remove the SmartKey from the ignition lock
- **with KEYLESS-GO:** open the driver's door; KEYLESS-GO must be in position **1**
- **with the SmartKey:** open the driver's door; the SmartKey must be in position **0** or **1** in the ignition lock (▷ page 162)
- open the driver's door when the ignition is switched off

 The steering wheel only tilts upwards and the driver's seat only moves backwards if the driving position is stored after seat or steering wheel adjustment.

The last position of the steering wheel or seat is stored if:

- the ignition is switched off
- the setting is stored with the memory function (▷ page 126).

 The steering wheel only moves upwards if it has not already reached the upper stop. The driver's seat only moves backwards if it is not already in the rearmost position.

## Position of the steering wheel and the driver's seat for driving

The steering wheel and the driver's seat are moved to the previously set position if:

- the driver's door is closed and you insert the SmartKey into the ignition lock
- you close the driver's door when the ignition is switched on
- you press the Start/Stop button once on vehicles with KEYLESS-GO

**i** The steering wheel and the driver's seat only return to the last set position when the driving position is stored after seat or steering wheel adjustment.

The last position of the steering wheel or seat is stored if:

- the ignition is switched off
- the setting is stored with the memory function (▷ page 126).

## Crash-responsive EASY-EXIT feature

If the crash-responsive EASY-EXIT feature is triggered in an accident, the steering column will move upwards when the driver's door is opened or the SmartKey is removed from the ignition lock. This makes it easier to exit the vehicle and rescue the occupants.

The crash-responsive EASY-EXIT feature is only operational if the EASY-EXIT/ENTRY feature is activated in the multimedia system (see the separate operating instructions).

## Mirrors

### Rear-view mirror



- **Anti-glare mode:** flick anti-glare lever ① forwards or back.

## Exterior mirrors

### Important safety notes

#### **⚠ WARNING**

You could lose control of your vehicle if you do the following while driving:

- adjust the driver's seat, head restraint, steering wheel or mirrors
- fasten the seat belt

There is a risk of an accident.

Adjust the driver's seat, head restraint, steering wheel and mirror and fasten your seat belt before starting the engine.

#### **⚠ WARNING**

The exterior mirror on the front-passenger side reduces the size of the image. Visible objects are actually closer than they appear. This means that you could misjudge the distance from road users traveling behind, e.g. when changing lane. There is a risk of an accident.

For this reason, always make sure of the actual distance from the road users traveling behind by glancing over your shoulder.

## Adjusting the exterior mirrors



- ▶ Turn the SmartKey to position **1** or **2** in the ignition lock (▷ page 162).
- ▶ Press button **②** for the right-hand exterior mirror or button **③** for the left-hand exterior mirror.  
The indicator lamp lights up in the button that has been pressed.  
The indicator lamp goes out again after some time. You can adjust the selected mirror using adjustment button **①** as long as the indicator lamp is lit.
- ▶ Press adjustment button **①** up, down, or to the left or right until you have adjusted the exterior mirror to the correct position. You should have a good overview of traffic conditions.

The convex exterior mirrors provide a larger field of vision.

After the engine has been started, the exterior mirrors are automatically heated if the rear window defroster is switched on and the outside temperature is low.

### Folding the exterior mirrors in or out electrically



- ▶ Turn the SmartKey to position **1** or **2** in the ignition lock (▷ page 162).
- ▶ Briefly press button **①**.  
Both exterior mirrors fold in or out.
- i** Make sure that the exterior mirrors are always folded out fully while driving. They could otherwise vibrate.
- i** If you are driving faster than 30 mph (47 km/h), you can no longer fold in the exterior mirrors.

### Setting the exterior mirrors

If the battery has been disconnected or completely discharged, the exterior mirrors must be reset. The exterior mirrors will otherwise not fold in when you select the "Fold in mirrors when locking" function in the on-board computer.

- ▶ Turn the SmartKey to position **1** or **2** in the ignition lock (▷ page 162).
- ▶ Press button **①**.

### Folding the exterior mirrors in or out automatically

When the **Automatic Mirror Folding** function is activated in the multimedia system (see the separate operating instructions):

- the exterior mirrors fold in automatically as soon as you lock the vehicle from the outside.
- the exterior mirrors fold out automatically again as soon as you unlock the vehicle.

**i** If the exterior mirrors have been folded in manually, they do not fold out.

### Exterior mirror pushed out of position

If an exterior mirror has been pushed out of position, proceed as follows:

- ▶ Press and hold button **①** until you hear a click and the mirror engages audibly into position (▷ page 124).  
The mirror housing is engaged again and you can adjust the exterior mirrors as usual (▷ page 123).

### Automatic anti-glare mirrors

#### **⚠ WARNING**

Electrolyte may escape if the glass in an automatic anti-glare mirror breaks. The electrolyte is harmful and causes irritation. It must not come into contact with your skin, eyes, respiratory organs or clothing or be swallowed. There is a risk of injury.

If you come into contact with the electrolyte, observe the following:

- Rinse off the electrolyte from your skin immediately with water.
- Immediately rinse the electrolyte out of your eyes thoroughly with clean water.
- If the electrolyte is swallowed, immediately rinse your mouth out thoroughly. Do not induce vomiting.
- If electrolyte comes into contact with your skin or hair or is swallowed, seek medical attention immediately.
- Immediately change out of clothing which has come into contact with electrolyte.
- If an allergic reaction occurs, seek medical attention immediately.

The rear-view mirror and the exterior mirror on the driver's side automatically go into anti-glare mode if the following conditions are met simultaneously:

- the ignition is switched on
- incident light from headlamps strikes the sensor in the rear-view mirror.

The mirrors do not go into anti-glare mode if reverse gear is engaged or if the interior lighting is switched on.

### Parking position for the exterior mirror on the front-passenger side

#### Setting and storing the parking position

You can position the front-passenger side exterior mirror in such a way that you can see the rear wheel on that side as soon as you engage reverse gear. You can store this position.

#### Using reverse gear



- ① Memory button **M**
- ② Adjustment button
- ③ Button for the front-passenger side exterior mirror
- ④ Button for the driver's side exterior mirror

▶ Turn the SmartKey to position **2** in the ignition lock (> page 162).

▶ Press button ③ for the exterior mirror on the front-passenger side.

▶ Engage reverse gear.

The exterior mirror on the front-passenger side moves to the preset parking position.

▶ Use adjustment button ② to adjust the exterior mirror to a position that allows you to see the rear wheel and the curb.

The parking position is stored.

**i** If you shift the transmission to another position, the exterior mirror on the front-passenger side returns to the driving position after approximately ten seconds.

#### Using the memory button

You can store the parking position of the exterior mirror on the front-passenger side using memory button **M** ①. The reverse gear must not be engaged during the process.

▶ Turn the SmartKey to position **2** in the ignition lock (> page 162).

▶ Press button ③ for the exterior mirror on the front-passenger side.

▶ Use adjustment button ② to adjust the exterior mirror to a position that allows you to see the rear wheel and the curb.

- ▶ Press memory button **M** ① and one of the arrows on adjustment button ② within three seconds.  
The parking position is stored if the exterior mirror does not move.
- ▶ If the mirror moves out of position, repeat the steps.

### Calling up a stored parking position setting

- ▶ Turn the SmartKey to position **2** in the ignition lock (▷ page 162).
- ▶ Adjust the exterior mirror on the front-passenger side using button ③.
- ▶ Engage reverse gear.  
The exterior mirror on the front-passenger side moves to the stored parking position.

The exterior mirror on the front-passenger side moves back to its original position:

- as soon as you exceed a speed of 9 mph (15 km/h)
- about ten seconds after you have disengaged reverse gear
- if you press button ④ for the exterior mirror on the driver's side

## Memory function

### Important safety notes

#### WARNING

If you use the memory function on the driver's side while driving, you could lose control of the vehicle as a result of the adjustments being made. There is a risk of an accident.

Only use the memory function on the driver's side when the vehicle is stationary.

#### WARNING

When the memory function adjusts the seat or steering wheel, you and other vehicle occupants – particularly children – could become trapped. There is a risk of injury.

While the memory function is making adjustments, make sure that no one has any body parts in the sweep of the seat or steering wheel. If somebody becomes trapped, imme-

diately release the memory function position button. The adjustment process is stopped.

#### WARNING

Children could become trapped if they activate the memory function, particularly when unattended. There is a risk of injury.

When leaving the vehicle, always take the SmartKey with you and lock the vehicle. Never leave children unsupervised in the vehicle.

The memory function can be used at any time, e.g. even when the SmartKey isn't in the ignition lock.

### Storing settings

The memory function is only available in vehicles with the memory package.

With the memory function, you can store up to three different settings, e.g. for three different people.

The following settings are stored as a single memory preset:

- seat, backrest, head restraint position and contour of the backrest in the lumbar region
- active multicontour seat: side bolsters of the backrest, shoulder of the backrest, contour of the backrest, dynamic function level
- seat heating: distribution of the heated sections of the seat cushion and backrest
- driver's side: position of the exterior mirrors on the driver's and front-passenger sides





- ▶ Adjust the seat accordingly (▷ page 106).
- ▶ On the driver's side, adjust the steering wheel (▷ page 120) and the exterior mirrors (▷ page 123).
- ▶ Press memory button **M** and one of the storage position buttons **1**, **2** or **3** within three seconds.  
The settings are stored in the selected preset position. A tone sounds when the settings have been completed.

### Calling up a stored setting

- ▶ Press and hold the relevant storage position button **1**, **2** or **3** until the:
  - Seat
  - Steering wheel
  - Exterior mirrors
 are in the stored position.
- i** If you release the storage position button, the seat, steering wheel and mirror setting functions stop immediately. The multicontour seat setting or the 4-way lumbar support is still carried out.

## Memory function in the rear compartment

### Important safety notes

#### WARNING

When the memory function adjusts the seat or steering wheel, you and other vehicle occupants – particularly children – could become trapped. There is a risk of injury.

While the memory function is making adjustments, make sure that no one has any body parts in the sweep of the seat or steering wheel. If somebody becomes trapped, immediately release the memory function position button. The adjustment process is stopped.



#### WARNING

Children could become trapped if they activate the memory function, particularly when unattended. There is a risk of injury.

When leaving the vehicle, always take the SmartKey with you and lock the vehicle. Never leave children unsupervised in the vehicle.

### General notes

The settings for the rear seat and the front-passenger seat can be stored using the rear-compartment memory function.

- If the indicator lamp in the  button is not lit, store the rear seat settings.
- If the indicator lamp in the  button lights up, store the front-passenger seat and rear seat settings. Both the front-passenger and rear seat are taken into account with this setting. Depending on the equipment in the vehicle, two or three memory positions can be stored for the front-passenger and rear seats.

### Storing settings

#### General notes

With the memory function in the rear, you can store up to three different settings, e.g. for three different people.

The following settings are stored as a single memory preset:

- position of the seat, backrest and head restraint
- multicontour seat: the seat cushions of the backrest as well as the contour of the backrest in the lumbar and shoulder regions
- seat heating: distribution of the heated sections of the seat cushion and backrest if the indicator lamp in the  button is not lit

The following settings are stored to a memory position, if the indicator lamp in the  button lights up:

- position of the footrest for the front-passenger seat, if available
- position of the screen, if available

### Vehicles without rear reclining seat





The SmartKey must be in the ignition lock and in position **1** or **2**, in order for the front-passenger seat to be selected (▷ page 162).

#### Selecting a rear-compartment seat

- ▶ Press the  button repeatedly until the indicator lamp in the button is not lit. The rear-compartment seat is selected if the indicator lamp in the button is not lit.
- ▶ Adjust the rear seat accordingly (▷ page 107).
- ▶ Press memory button **M** and one of the storage position buttons **1**, **2** or **3** within three seconds. The settings are stored in the selected storage position.

#### Selecting the front-passenger seat and rear-compartment seat

- ▶ Press the  button repeatedly until the indicator lamp in the button is not lit. The rear-compartment seat is selected if the indicator lamp in the button is not lit.
- ▶ Adjust the rear seat accordingly (▷ page 107).
- ▶ Press the  button repeatedly until the indicator lamp in the button lights up. The front-passenger seat is selected if the indicator lamp in the button lights up.
- ▶ Adjust the front-passenger seat accordingly (▷ page 108).
- ▶ Press memory button **M** and one of the storage position buttons **1**, **2** or **3** within three seconds. The settings are stored in the selected storage position.

### Vehicles with a rear reclining seat





The SmartKey must be in the ignition lock and in position **1** or **2**, in order for the front-passenger seat to be selected (▷ page 162).

#### Selecting a rear-compartment seat

- ▶ Press the  button repeatedly until the indicator lamp in the button is not lit. The rear-compartment seat is selected if the indicator lamp in the button is not lit.
- ▶ Adjust the rear seat accordingly (▷ page 107).
- ▶ Press the **M** memory button and then press either the **1** or **2** memory button within three seconds. The settings are stored in the selected storage position.

#### Selecting the front-passenger seat and rear-compartment seat

- ▶ Press the  button repeatedly until the indicator lamp in the button is not lit. The rear-compartment seat is selected if the indicator lamp in the button is not lit.
- ▶ Adjust the rear seat accordingly (▷ page 107).
- ▶ Press the  button repeatedly until the indicator lamp in the button lights up. The front-passenger seat is selected if the indicator lamp in the button lights up.
- ▶ Adjust the front-passenger seat accordingly (▷ page 108).
- ▶ Press the **M** memory button and then press either the **1** or **2** memory button within three seconds. The settings are stored in the selected storage position.

You cannot store any settings on the button for setting the reclined position.



## Calling up a stored setting

### General notes

The memory positions in the area for the chauffeur mode can only be set when the conditions for the chauffeur mode are fulfilled (▷ page 111).

### Vehicles without rear reclining seat



The SmartKey must be in the ignition lock and in position **1** or **2**, in order for the front-passenger seat to be selected (▷ page 162).

- ▶ **To call up the stored rear seat setting:**  
press the  button repeatedly until the indicator lamp in the button is not lit.
- ▶ **To call up the stored front-passenger seat and rear seat settings:** press the  button repeatedly until the indicator lamp in the button lights up.
- ▶ Press and hold the relevant storage position button **1**, **2** or **3** until the rear seat or the front-passenger seat are in the stored position.

**i** Seat adjustment is interrupted as soon as you release the storage position button. The adjustment of the multicontour seat is still carried out.

### Vehicles with a rear reclining seat

The SmartKey must be in the ignition lock and in position **1** or **2**, in order for the front-passenger seat to be selected (▷ page 162).

- ▶ **To call up the stored rear seat setting:**  
press the  button repeatedly until the indicator lamp in the button is not lit.
- ▶ **To call up the stored front-passenger seat and rear seat settings:** press the  button repeatedly until the indicator lamp in the button lights up.
- ▶ Press and hold the relevant storage position button **1** or **2** until the rear seat or the front-passenger seat is in the stored position.

**i** Seat adjustment is interrupted as soon as you release the storage position button. The adjustment of the multicontour seat is still carried out.

## Useful information

- i** This Operator's Manual describes all models and all standard and optional equipment of your vehicle available at the time of publication of the Operator's Manual. Country-specific differences are possible. Please note that your vehicle may not be equipped with all features described. This also applies to safety-related systems and functions.
- i** Read the information on qualified specialist workshops (> page 28).

## Exterior lighting

### General notes

For reasons of safety, Mercedes-Benz recommends that you drive with the lights switched on even during the daytime. In some countries, operation of the headlamps varies due to legal requirements and self-imposed obligations.

### Setting the exterior lighting

#### Setting options

Exterior lighting can be set using:

- the light switch
- the combination switch (> page 131)
- the on-board computer (> page 274)

#### Light switch

##### Operation



- 1** Left-hand standing lamps
- 2** Right-hand standing lamps

- 3** Parking lamps, license plate and instrument cluster lighting
- 4** Automatic headlamp mode, controlled by the light sensor
- 5** Low-beam/high-beam headlamps

If you hear a warning tone when you leave the vehicle, the lights may still be switched on.

- Turn the light switch to the **AUTO** position.

The exterior lighting (except the parking/standing lamps) switches off automatically if you:

- remove the SmartKey from the ignition lock
- open the driver's door with the SmartKey in position **0** in the ignition lock

### Automatic headlamp mode

#### WARNING

When the light switch is set to **AUTO**, the low-beam headlamps may not be switched on automatically if there is fog, snow or other causes of poor visibility due to the weather conditions such as spray. There is a risk of an accident.

In such situations, turn the light switch to



The automatic headlamp feature is only an aid. The driver is responsible for the vehicle's lighting at all times.

#### Canada only:

The daytime running lamps improve the visibility of your vehicle during the day. The daytime running lamps function is required by law in Canada. It cannot therefore be deactivated.

When the engine is running and the vehicle is stationary: if you move the selector lever from a drive position to **P**, the daytime running lamps/low-beam headlamps go out after three minutes.



When the engine is running, the vehicle is stationary and in bright ambient light: if you turn the light switch to the position, the daytime running lamps and parking lamps switch on.

If the engine is running and you turn the light switch to the position, the manual settings take precedence over the daytime running lamps.

#### USA only:

The daytime running lamps improve the visibility of your vehicle during the day. Here, the Day-

**time Running Lights** function must be switched on via the on-board computer (▷ page 274).



If the engine is running and you turn the light switch to the  or  position, the manual settings take precedence over the daytime running lamps.

**AUTO** is the favored light switch setting. The light setting is automatically selected according to the brightness of the ambient light (exception: poor visibility due to weather conditions such as fog, snow or spray):



- SmartKey in position **1** in the ignition lock: the parking lamps are switched on or off automatically depending on the brightness of the ambient light.
  - With the engine running: if you have switched on the **Daytime Running Lights** function in the on-board computer, the daytime running lamps or the parking lamps and low-beam headlamps are switched on or off automatically depending on the brightness of the ambient light.
- ▶ **To switch on the automatic headlamps:** turn the light switch to the **AUTO** position.



### Low-beam headlamps

Even if the light sensor does not detect that it is dark, the parking lamps and low-beam headlamps switch on when the ignition is switched on and the light switch is set to the  position. This is a particularly useful function in the event of rain and fog.

- ▶ **To switch on the low-beam headlamps:** turn the SmartKey in the ignition lock to position **2** or start the engine.
- ▶ Turn the light switch to the  position. The green  indicator lamp in the instrument cluster lights up.



### Parking lamps

**!** If the battery charge is very low, the parking lamps or standing lamps are automatically switched off to enable the next engine start. Always park your vehicle safely and sufficiently lit according to legal standards. Avoid using the parking lamps  over a period of several hours. If possible, switch on the right-hand  or left-hand  standing lamp.

- ▶ **To switch on:** turn the light switch to the  position. The green  indicator lamp in the instrument cluster lights up.

### Standing lamps

Switching on the standing lamps ensures the corresponding side of the vehicle is illuminated.

- ▶ **To switch on the standing lamps:** the SmartKey should not be in the ignition lock or it should be in position **0**.
- ▶ Turn the light switch to the  (left-hand side of the vehicle) or  ((right-hand side of the vehicle) position.

### Combination switch

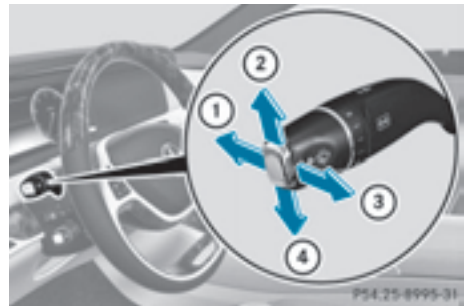

#### Turn signal





- ① High-beam headlamps
- ② Turn signal, right
- ③ High-beam flasher
- ④ Turn signal, left

- ▶ **To indicate briefly:** press the combination switch briefly to the pressure point in the direction of arrow **②** or **④**. The corresponding turn signal flashes three times.
- ▶ **To indicate:** press the combination switch beyond the pressure point in the direction of arrow **②** or **④**.

## High-beam headlamps

- ▶ **To activate manually:** turn the SmartKey in the ignition lock to position **2** or start the engine.
- ▶ Vehicles without Adaptive Highbeam Assist Plus: turn the light switch to position  or **AUTO**.
- ▶ Vehicles with Adaptive Highbeam Assist Plus: turn the light switch to the  position.
- ▶ Press the combination switch beyond the pressure point in the direction of arrow ①. In the **AUTO** position, the high-beam headlamps are only switched on when it is dark and the engine is running.

The blue  indicator lamp in the instrument cluster lights up when the high-beam headlamps are switched on.

- ▶ **To switch off:** move the combination switch back to its normal position. The blue  indicator lamp in the instrument cluster goes out.

### Vehicles with Adaptive Highbeam Assist Plus:

if Adaptive Highbeam Assist Plus is activated, it automatically controls activation and deactivation of the high-beam headlamps (▷ page 133).

## High-beam flasher

- ▶ **To switch on:** turn the SmartKey in the ignition lock to position **1** or **2**, or start the engine.
- ▶ Pull the combination switch in the direction of arrow ③.

## Hazard warning lamps



- ▶ **To switch on the hazard warning lamps:** press button ①.

All turn signals flash. If you now switch on a turn signal using the combination switch, only the turn signal lamp on the corresponding side of the vehicle will flash.

- ▶ **To switch off the hazard warning lamps:** press button ①.

The hazard warning lamps automatically switch on if:

- an air bag is deployed or
- the vehicle decelerates rapidly from a speed of above 45 mph (70 km/h) and comes to a standstill

The hazard warning lamps switch off automatically if the vehicle reaches a speed of above 6 mph (10 km/h) again after a full brake application.

The hazard warning lamps still operate if the ignition is switched off.

## Cornering light function



The cornering light function improves the illumination of the road over a wide angle in the direction you are turning, enabling better visibility in tight bends, for example. It can only be activated when the low-beam headlamps are switched on.

### Active:

- if you are driving at speeds below 25 mph (40 km/h) and switch on the turn signal or turn the steering wheel
- if you are driving at speeds between 25 mph (40 km/h) and 45 mph (70 km/h) and turn the steering wheel

The cornering lamp may remain lit for a short time, but is automatically switched off after no more than three minutes.

## Adaptive Highbeam Assist Plus

### General notes



With Adaptive Highbeam Assist Plus, you can automatically switch between low-beam, partial high-beam and high-beam headlamps.

Partial high-beam is a form of illumination whereby the high-beam is directed past other road users. Other road users are kept out of the high-beam. This prevents glare. When there is a vehicle in front, for example, the high-beam headlamps illuminate the areas to its right and left, and the vehicle in front is illuminated by the low-beam headlamps.

The system automatically adapts the low-beam headlamp range depending on the distance to the other vehicle. Once the system no longer detects any other vehicles, it reactivates the high-beam headlamps.

If the high-beam or partial high-beam are causing too much reflection from traffic signs, the lights are automatically dimmed and glare for the driver caused by the reflections is thus avoided.

The system's optical sensor is located behind the windshield near the overhead control panel.

### Important safety notes

#### WARNING

Adaptive Highbeam Assist Plus does not recognize road users:

- who have no lights, e.g. pedestrians
- who have poor lighting, e.g. cyclists
- whose lighting is blocked, e.g. by a barrier

In very rare cases, Adaptive Highbeam Assist Plus may not recognize road users who do have lights, or may recognize them too late. In this or similar situations, the automatic high-beam headlamps will not be deactivated or will be activated regardless. There is a risk of an accident.

Always carefully observe the traffic conditions and switch off the high-beam headlamps in good time.

Adaptive Highbeam Assist Plus cannot take into account road, weather or traffic conditions. Adaptive Highbeam Assist Plus is only an aid. You are responsible for adjusting the vehicle's lighting to the prevailing light, visibility and traffic conditions.

In particular, the detection of obstacles can be restricted if there is:

- poor visibility, e.g. due to fog, heavy rain or snow
- dirt on the sensors or the sensors are obscured

### Switching Adaptive Highbeam Assist PLUS on/off

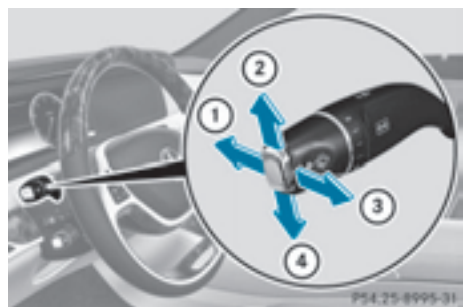

- ① High-beam headlamps
- ② Turn signal, right

- ③ High-beam flasher
- ④ Turn signal, left

► **To switch on:** turn the light switch to **Auto**.

► Press the combination switch beyond the pressure point in the direction of arrow ①. The  indicator lamp in the multifunction display lights up if it is dark and the light sensor activates the low-beam headlamps.

**At speeds above approx. 16 mph (25 km/h):** the headlamp range is set automatically depending on the distance between the vehicle and other road users.

**At speeds above approx. 19 mph (30 km/h):**

- If no other road users are detected, the high-beam headlamps are automatically switched on.
- If other road users are detected, the partial high-beam headlamps are automatically switched on.

The  indicator lamp in the instrument cluster also lights up.

**At speeds below approx. 16 mph (25 km/h) or when there is sufficient street lighting:**

- The partial high-beam headlamps are switched off automatically.
- The high-beam headlamps are switched off automatically.

The  indicator lamp in the instrument cluster goes out. The  indicator lamp in the multifunction display remains lit.

► **To switch off:** move the combination switch back to its normal position or move the light switch to another position.

The  indicator lamp in the multifunction display goes out.

### Headlamps fogged up on the inside





Certain climatic and physical conditions may cause moisture to form in the headlamp. This moisture does not affect the functionality of the headlamp.

## Interior lighting

### Overview of interior lighting

#### Front overhead control panel



- ①  Switches the left-hand front reading lamp on/off
- ②  Switches the automatic interior lighting control on/off
- ③  Switches the front interior lighting on/off
- ④  Switches the rear compartment interior lighting on/off
- ⑤  Switches the right-hand front reading lamp on/off

#### Control panel in the grab handle (rear compartment)



- **To switch on the corresponding side of the vehicle:** press button ②. Reading lamp ① and the make-up lamp light up.
- **To switch off:** press button ②. Press once: the make-up lamp goes out. Press twice: reading lamp ① goes out.



- ▶ **To switch on both sides of the vehicle:** press button ③.  
Reading lamp ① and the make-up lamp light up.
- ▶ **To switch off:** press button ③.  
Reading lamp ① and the make-up lamp go out.

## Interior lighting control

### General notes

In order to prevent the vehicle's battery from discharging, the interior lighting functions are automatically deactivated after some time except when the SmartKey is in position **2** in the ignition lock.

The color, brightness, zone and display lighting for the ambient lighting are set using the multimedia system (see the separate operating instructions).

The interior lighting control can be operated using the front overhead control panel.

### Automatic interior lighting control



- ▶ **To switch on or off:** press the  button.  
When the automatic interior lighting control is activated, the button is flush with the overhead control panel.

The interior lighting automatically switches on if you:

- unlock the vehicle
- open a door
- remove the SmartKey from the ignition lock

The interior light is activated for a short while when the SmartKey is removed from the ignition lock. This delayed switch-off can be adjusted via the multimedia system (see the separate operating instructions).

### Manual interior lighting control

- ▶ **To switch the front interior lighting on/off:** press the  button.
- ▶ **To switch the rear compartment interior lighting on/off:** press the  button.
- ▶ **To switch the reading lamp on/off:** press the  button.

## Crash-responsive emergency lighting

The interior lighting is activated automatically if the vehicle is involved in an accident.

- ▶ **To switch off the crash-responsive emergency lighting:** press the hazard warning lamp button.

or

- ▶ Lock and then unlock the vehicle using the SmartKey.

## Replacing bulbs

The front and rear light clusters of your vehicle are equipped with LED light bulbs. Do not replace the bulbs yourself. Contact a qualified specialist workshop which has the necessary specialist knowledge and tools to carry out the work required.

Lamps are an important aspect of vehicle safety. You must therefore make sure that these function correctly at all times. Have the headlamp setting checked regularly.

## Windshield wipers

### Switching the windshield wipers on/off

- ! Do not operate the windshield wipers when the windshield is dry, as this could damage the wiper blades. Moreover, dust that has collected on the windshield can scratch the glass if wiping takes place when the windshield is dry.



If it is necessary to switch on the windshield wipers in dry weather conditions, always use washer fluid when operating the windshield wipers.

- ! If the windshield wipers leave smears on the windshield after the vehicle has been washed in an automatic car wash, wax or other residues may be the reason for this. Clean the windshield using washer fluid after washing the vehicle in an automatic car wash.

- ! Vehicles with a rain sensor: if the windshield becomes dirty in dry weather conditions, the windshield wipers may be activated inadvertently. This could then damage the windshield wiper blades or scratch the windshield.

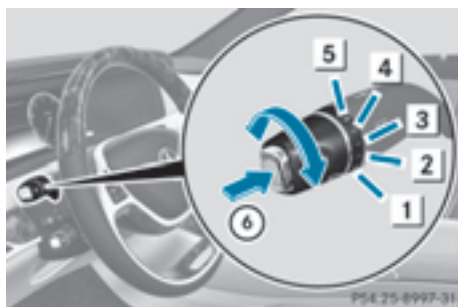
For this reason, you should always switch off the windshield wipers in dry weather.



- 1 **0** Windshield wiper off
- 2 **•••** Intermittent wipe, low (rain sensor set to low sensitivity)
- 3 **••••** Intermittent wipe, high (rain sensor set to high sensitivity)
- 4 **—** Continuous wipe, slow
- 5 **==** Continuous wipe, fast
- 6  Single wipe /  to wipe the windshield using washer fluid

- ▶ Switch on the power supply with the Start/Stop button or the SmartKey (▷ page 162).
- ▶ Turn the combination switch to the corresponding position.

In the **•••** or **••••** position, the appropriate wiping frequency is set automatically according to the intensity of the rain. In the **••••** position, the rain sensor is more sensitive than in the **•••** position, causing the windshield wipers to wipe more frequently.

Vehicles with MAGIC VISION CONTROL: the washer fluid is fed through the wiper blades and when wiping with washer fluid  the washer fluid is emitted directly from the blades.

Vehicles with MAGIC VISION CONTROL: if you push and hold the combination switch beyond the point of resistance in the direction of arrow ⑥, the manual wash program is activated. If you briefly push and hold the combination switch beyond the point of resistance in the direction of arrow ⑥, the automatic wash program is activated.

If the wiper blades are worn, the windshield will no longer be wiped properly. This could prevent you from observing the traffic conditions.

## Replacing the wiper blades

### Important safety notes

#### WARNING

If the windshield wipers begin to move while you are changing the wiper blades, you could be trapped by the wiper arm. There is a risk of injury.

Always switch off the windshield wipers and ignition before changing the wiper blades.

-  To avoid damaging the wiper blades, make sure that you touch only the wiper arm of the wiper.

-  Never open the hood if a windshield wiper arm has been folded away from the windshield.

Hold the windshield wiper arm firmly when you change the wiper blade. If you release the windshield wiper arm without a wiper blade and it falls onto the windshield, the windshield may be damaged by the force of the impact. Mercedes-Benz recommends that you have the wiper blades changed at a qualified specialist workshop.

-  Always position the windshield wiper arms vertically before folding them away from the windshield. By doing so, you will avoid damage to the hood.

### Replacing the wiper blades (standard windshield wipers)

#### Moving the wiper arms to a vertical position

##### On vehicles without KEYLESS-GO:

- ▶ Turn the SmartKey to position **0** in the ignition lock (▷ page 162).
- ▶ Set the windshield wiper to the **—** position.
- ▶ Turn the SmartKey to position **1** in the ignition lock (▷ page 162).
- ▶ As soon as the wiper arms are vertical to the hood, turn the SmartKey to position **0** in the ignition lock (▷ page 162).
- ▶ Remove the SmartKey.
- ▶ Fold the wiper arms away from the windshield until you feel them snap into place.

**On vehicles with KEYLESS-GO:**

- ▶ Switch off the engine.
- ▶ Remove your foot from the brake pedal.
- ▶ Set the windshield wipers to position .
- ▶ Press the Start/Stop button repeatedly until the windshield wiper starts.
- ▶ When the wiper arms have reached the vertical position, press the Start/Stop button repeatedly until the windshield wipers stop.
- ▶ Fold the wiper arms away from the windshield until you feel them snap into place.

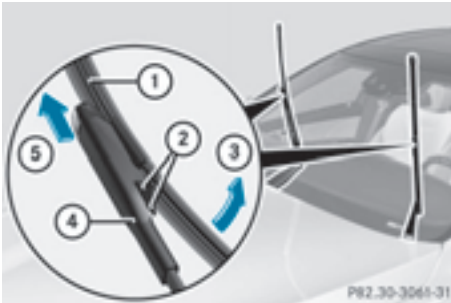
**Removing the wiper blades**

- ▶ Press both release clips (2).
- ▶ Fold wiper blade (1) in the direction of arrow (3) away from wiper arm (4).
- ▶ Remove wiper blade (1) in the direction of arrow (5).

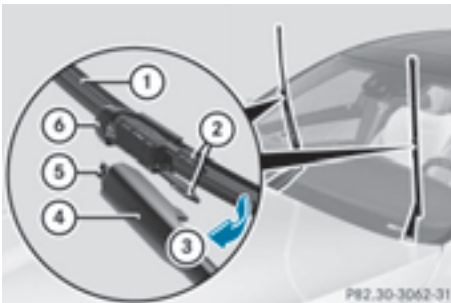
**Installing the wiper blades**

- ▶ Position the new wiper blade (1) with recess (6) on lug (5).
- ▶ Fold wiper blade (1) in the direction of arrow (3) onto the wiper arm, until retaining clips (2) engage in bracket (4).

- ▶ Make sure that wiper blade (1) is seated correctly.
- ▶ Fold the wiper arm back onto the windshield.

**Replacing the wiper blades (MAGIC VISION CONTROL)****Moving the wiper arms to a vertical position****On vehicles without KEYLESS-GO:**

- ▶ Turn the SmartKey to position **0** in the ignition lock (▷ page 162).
- ▶ Set the windshield wiper to position  on the combination switch.
- ▶ Turn the SmartKey to position **1** in the ignition lock (▷ page 162).
- ▶ As soon as the wiper arms are vertical to the hood, turn the SmartKey to position **0** in the ignition lock (▷ page 162).
- ▶ Remove the SmartKey.
- ▶ Fold the wiper arms away from the windshield until you feel them snap into place.

**On vehicles with KEYLESS-GO:**

- ▶ Switch off the engine.
- ▶ Remove your foot from the brake pedal.
- ▶ Set the windshield wiper to the  position.
- ▶ Press the Start/Stop button repeatedly until the windshield wiper starts.
- ▶ When the wiper arms have reached the vertical position, press the Start/Stop button repeatedly until the windshield wiper stops.
- ▶ Fold the wiper arms away from the windshield until you feel them snap into place.

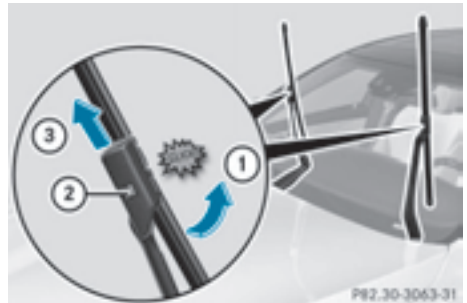
**Removing a wiper blade**

- ▶ **To bring the wiper blade into position to be removed:** hold the wiper arm firmly with

one hand. With the other hand, turn the wiper blade in the direction of arrow ① beyond the point of resistance.

The wiper blade engages in the removal position with an audible click.

- ▶ **To remove a wiper blade:** firmly press release knob ② and pull the wiper blade upwards ③.

### Installing the wiper blades



- ▶ Push the new wiper blade in the direction of arrow ① onto the wiper arm until tab ② engages.
- ▶ Push the wiper blade out of the removal position in the direction of arrow ③ beyond the point of resistance. The wiper blade disengages with an audible click and is freely movable again.
- ▶ Make sure that the wiper blade is seated correctly.
- ▶ Fold the wiper arm back onto the windshield.

### Problems with the windshield wipers

Problem	Possible causes/consequences and ► Solutions
The windshield wipers are jammed.	<p>Leaves or snow, for example, may be obstructing the windshield wiper movement. The wiper motor has been deactivated.</p> <ul style="list-style-type: none"> <li>► Switch off the engine using the Start/Stop button and open the driver's door.</li> <li>► Remove the cause of the obstruction.</li> <li>► Switch the windshield wipers back on.</li> </ul>
The windshield wipers fail completely.	<p>The windshield wiper drive is malfunctioning.</p> <ul style="list-style-type: none"> <li>► Select another wiper speed on the combination switch.</li> <li>► Have the windshield wipers checked at a qualified specialist workshop.</li> </ul>
	<p>The wiper motor has been deactivated.</p> <ul style="list-style-type: none"> <li>► Switch off the engine using the Start/Stop button and open the driver's door.</li> <li>► Remove the cause of the obstruction.</li> <li>► Switch the windshield wipers back on.</li> </ul>
For a standard wiper system only: the windshield washer fluid from the spray nozzles no longer hits the center of the windshield.	<p>The spray nozzles are misaligned.</p> <ul style="list-style-type: none"> <li>► Have the spray nozzles adjusted at a qualified specialist workshop.</li> </ul>

### Useful information

- i** This Operator's Manual describes all models and all standard and optional equipment of your vehicle available at the time of publication of the Operator's Manual. Country-specific differences are possible. Please note that your vehicle may not be equipped with all features described. This also applies to safety-related systems and functions.
- i** Read the information on qualified specialist workshops (> page 28).

rior temperature will be reached more quickly.

- i** The integrated filter filters out most particles of dust and soot and completely filters out pollen. It also reduces gaseous pollutants and odors. A clogged filter reduces the amount of air supplied to the vehicle interior. For this reason, you should always observe the interval for replacing the filter, which is specified in the Maintenance Booklet. As it depends on environmental conditions, e.g. heavy air pollution, the interval may be shorter than stated in the Maintenance Booklet.

### Overview of climate control systems

#### General notes

Observe the settings recommended on the following pages. The windows could otherwise fog up.

To prevent the windows from fogging up:

- switch off climate control only briefly
- switch on air-recirculation mode only briefly
- switch on the cooling with air dehumidification function
- switch on the defrost windshield function briefly, if required

Climate control regulates the temperature and air humidity in the vehicle interior. The air filter cleans the air, thus improving the interior climate.

For vehicles with a combustion engine, the "Cooling with air dehumidification" function is only available when the engine is running. For hybrid vehicles, the "Cooling with air dehumidification" function is also available via the electric refrigerant compressor when the engine is not running. Optimum climate control is only achieved with the side windows and roof closed.

If you start the engine using your smartphone, the last selected climate control setting is reactivated (> page 164).

The residual heat function can only be activated or deactivated with the ignition switched off (> page 152).

- i** Ventilate the vehicle for a brief period during warm weather, e.g. using the convenience opening feature (> page 95). This will speed up the cooling process and the desired inte-

## Automatic climate control panel

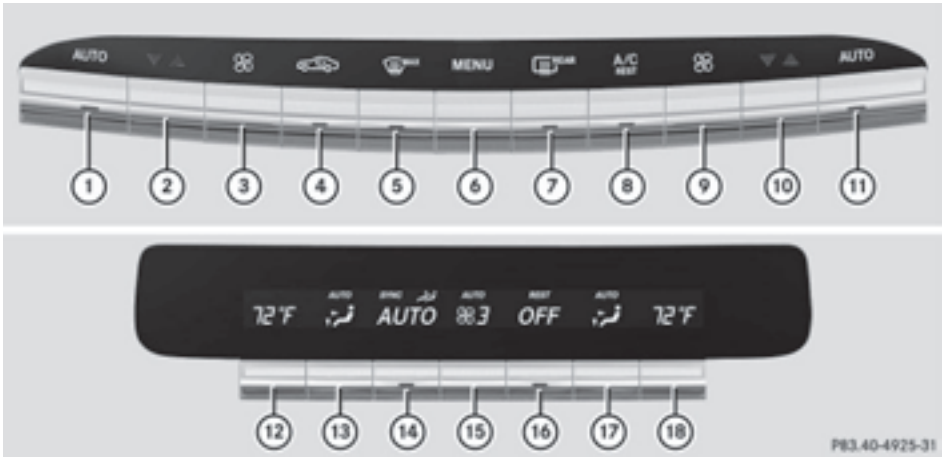

USA only

**Front control panel**

- ① Sets climate control to automatic, left (▷ page 147)
- ② Sets the temperature, left (▷ page 148)
- ③ Sets the airflow, left (▷ page 150)
- ④ Switches air-recirculation mode on/off (▷ page 152)
- ⑤ Defrosts the windshield (▷ page 151)
- ⑥ Calls up the climate control menu of the multimedia system (see separate operating instructions)
- ⑦ Switches the rear window defroster on/off (▷ page 151)
- ⑧ Switches cooling with air dehumidification on/off (▷ page 146)  
Switches the residual heat on or off (▷ page 152)
- ⑨ Sets the airflow, right (▷ page 150)
- ⑩ Sets the temperature, right (▷ page 148)
- ⑪ Sets climate control to automatic, right (▷ page 147)

**Rear control panel (vehicles with rear-compartment climate control)**

- ⑫ Sets the temperature, left (▷ page 148)
- ⑬ Sets the air distribution, left (▷ page 149)
- ⑭ Sets climate control to automatic (▷ page 147)
- ⑮ Sets the airflow (▷ page 150)
- ⑯ Activates/deactivates climate control (▷ page 145)  
Switches the residual heat on or off (▷ page 152)
- ⑰ Sets the air distribution, right (▷ page 149)
- ⑱ Sets the temperature, right (▷ page 148)

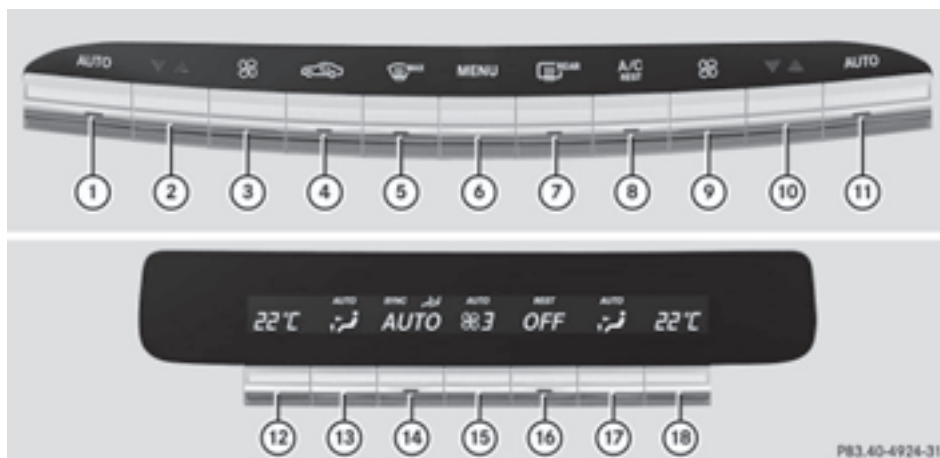

Canada only

### Front control panel

- ① Sets climate control to automatic, left (▷ page 147)
- ② Sets the temperature, left (▷ page 148)
- ③ Sets the airflow, left (▷ page 150)
- ④ Switches air-recirculation mode on/off (▷ page 152)
- ⑤ Defrosts the windshield (▷ page 151)
- ⑥ Calls up the climate control menu of the multimedia system (see separate operating instructions)
- ⑦ Switches the rear window defroster on/off (▷ page 151)
- ⑧ Switches cooling with air dehumidification on/off (▷ page 146)  
Switches the residual heat on or off (▷ page 152)
- ⑨ Sets the airflow, right (▷ page 150)
- ⑩ Sets the temperature, right (▷ page 148)
- ⑪ Sets climate control to automatic, right (▷ page 147)

### Rear control panel (vehicles with rear-compartment climate control)

- ⑫ Sets the temperature, left (▷ page 148)
- ⑬ Sets the air distribution, left (▷ page 149)
- ⑭ Sets climate control to automatic (▷ page 147)
- ⑮ Sets the airflow (▷ page 150)
- ⑯ Activates/deactivates climate control (▷ page 145)  
Switches the residual heat on or off (▷ page 152)
- ⑰ Sets the air distribution, right (▷ page 149)
- ⑱ Sets the temperature, right (▷ page 148)



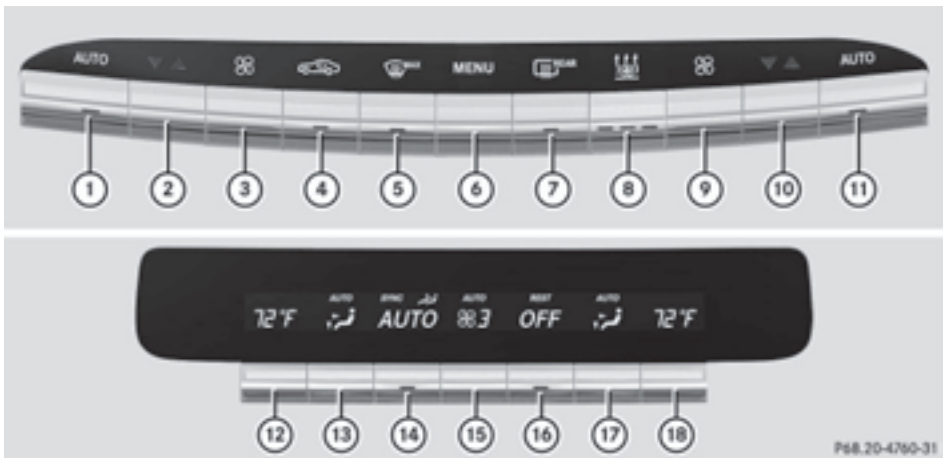

PLUG-IN HYBRID (USA only)

### Front control panel

- ① Sets climate control to automatic, left (▷ page 147)
- ② Sets the temperature, left (▷ page 148)
- ③ Sets the airflow, left (▷ page 150)
- ④ Activates/deactivates air-recirculation mode manually (▷ page 152)
- ⑤ Defrosts the windshield (▷ page 151)
- ⑥ Calls up the climate control menu of the multimedia system (see separate operating instructions)

Switches the residual heat on or off (▷ page 152)

- ⑦ Switches the rear window defroster on/off (▷ page 151)
- ⑧ Activates/deactivates "Immediate pre-entry climate control" (▷ page 158)
- ⑨ Sets the airflow, right (▷ page 150)
- ⑩ Sets the temperature, right (▷ page 148)
- ⑪ Sets climate control to automatic, right (▷ page 147)

### Rear control panel (vehicles with rear-compartment climate control)

- ⑫ Sets the temperature, left (▷ page 148)
  - ⑬ Sets the air distribution, left (▷ page 149)
  - ⑭ Sets climate control to automatic (▷ page 147)
  - ⑮ Sets the airflow (▷ page 150)
  - ⑯ Activates/deactivates climate control (▷ page 145)
- Switches the residual heat on or off (▷ page 152)
- ⑰ Sets the air distribution, right (▷ page 149)
  - ⑱ Sets the temperature, right (▷ page 148)

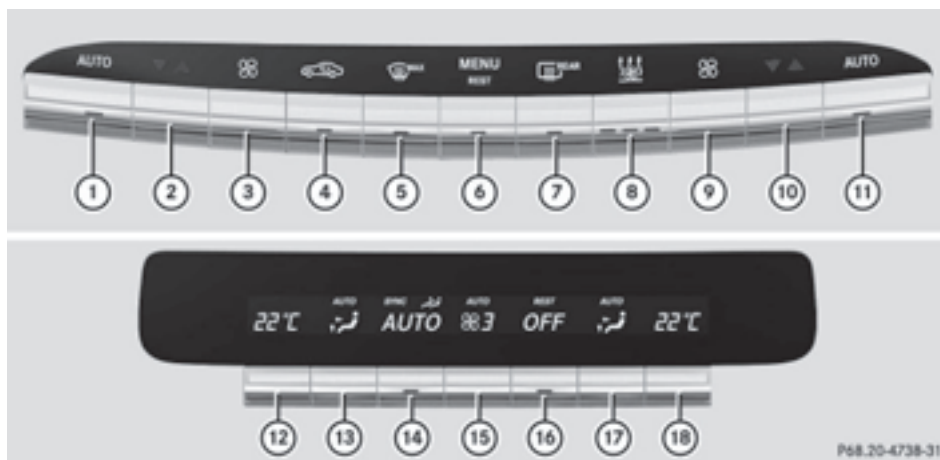

PLUG-IN HYBRID (Canada only)

### Front control panel

- ① Sets climate control to automatic, left (▷ page 147)
- ② Sets the temperature, left (▷ page 148)
- ③ Sets the airflow, left (▷ page 150)
- ④ Activates/deactivates air-recirculation mode manually (▷ page 152)
- ⑤ Defrosts the windshield (▷ page 151)
- ⑥ Calls up the climate control menu of the multimedia system (see separate operating instructions)

Switches the residual heat on or off (▷ page 152)

- ⑦ Switches the rear window defroster on/off (▷ page 151)
- ⑧ Activates/deactivates "Immediate pre-entry climate control" (▷ page 158)
- ⑨ Sets the airflow, right (▷ page 150)
- ⑩ Sets the temperature, right (▷ page 148)
- ⑪ Sets climate control to automatic, right (▷ page 147)

### Rear control panel (vehicles with rear-compartment climate control)

- ⑫ Sets the temperature, left (▷ page 148)
  - ⑬ Sets the air distribution, left (▷ page 149)
  - ⑭ Sets climate control to automatic (▷ page 147)
  - ⑮ Sets the airflow (▷ page 150)
  - ⑯ Activates/deactivates climate control (▷ page 145)
- Switches the residual heat on or off (▷ page 152)
- ⑰ Sets the air distribution, right (▷ page 149)
  - ⑱ Sets the temperature, right (▷ page 148)

## Notes on using automatic climate control

### Climate control system

Below, you can find a number of notes and recommendations to help you use climate control optimally.

- Activate climate control using the **AUTO** rocker switch. The indicator lamp in the **AUTO** rocker switch lights up.
- Set the temperature to 72 °F (22 °C).
- Only use the "Windshield defrosting" function briefly until the windshield is clear again.
- Only use air-recirculation mode briefly, e.g. if there are unpleasant outside odors or when in a tunnel. The windows could otherwise fog up, since no fresh air is drawn into the vehicle in air-recirculation mode.
- Use the residual heat function if you want to heat or ventilate the vehicle interior when the ignition is switched off. The residual heat function can only be activated or deactivated with the ignition switched off. The residual heat function is switched off when the ignition is switched on.

If you are controlling the rear-compartment climate control using the front control panel, note the following:

- If you set rear-compartment climate control using the front control panel, the  symbol appears in the rear-compartment control panel display.
- If the rear-compartment climate control is set using the front control panel, it cannot be set at the same time using the rear control panel. After completing the settings for the rear-compartment climate control using the front control panel, wait five seconds. You will then be able to control the rear climate control using the rear control panel.
- After selecting the rear compartment settings, the front climate control can be controlled automatically again via the multimedia system after five seconds.

Alternatively, you can select "Cancel rear compartment" in the multimedia system air-conditioning function bar.

### ECO start/stop function

During automatic engine switch-off, the climate control system only operates at a reduced capacity. If you require the full climate control output, you can switch off the ECO start/stop function by pressing the ECO button (▷ page 167).

## Operating the climate control systems

### Activating/deactivating climate control

#### General notes

When the climate control is switched off, the air supply and air circulation are also switched off. The windows could fog up. Therefore, switch off climate control only briefly





Switch on climate control primarily using the **AUTO** rocker switch (▷ page 147).

### Activating/deactivating front climate control using the front control panel





- ▶ Turn the SmartKey to position **2** in the ignition lock (▷ page 162).
- ▶ **To activate:** press the **MENU** or **MENU REST** rocker switch up or down.  
The climate control menu opens.
- ▶ Activate climate control via the air-conditioning setting bar in the multimedia system (see the separate operating instructions).
- ▶ **To deactivate:** press the **MENU** or **MENU REST** rocker switch up or down.  
The climate control menu opens.
- ▶ Activate climate control via the air-conditioning setting bar in the multimedia system (see the separate operating instructions).

### Activating/deactivating rear-compartment climate control using the front control panel

Observe the notes on controlling the rear-compartment climate control using the front control panel (▷ page 145).

- ▶ Turn the SmartKey to position **2** in the ignition lock (▷ page 162).
- ▶ **To activate:** press the  or  rocker switch up or down.  
The climate control menu opens.
- ▶ Select "Rear adjustment" in the air-conditioning setting bar (see the separate operating instructions).  
You can control the rear-compartment climate control using the front control panel or via the multimedia system.
- ▶ Activate rear-compartment climate control via the air-conditioning setting bar.
- ▶ **To deactivate:** press the  or  rocker switch up or down.  
The climate control menu opens.
- ▶ Select "Rear adjustment" in the air-conditioning setting bar (see the separate operating instructions).
- ▶ Deactivate rear-compartment climate control via the air-conditioning setting bar.

### Activating/deactivating rear-compartment climate control using the rear control panel

- ▶ Turn the SmartKey to position **2** in the ignition lock (▷ page 162).
- ▶ **To activate:** press rocker switch  up or down (▷ page 141).  
The indicator lamp in rocker switch  goes out. All settings are displayed in full in the rear-compartment display.
- ▶ **To deactivate:** press rocker switch  up or down (▷ page 141).  
The indicator lamp in rocker switch  lights up. **OFF** is displayed in the rear-compartment display.

### Switching cooling with air dehumidification on/off



#### General notes

If you deactivate the "Cooling with air-dehumidification" function, the air inside the vehicle will not be cooled. The air inside the vehicle will also not be dehumidified. The windows can fog up more quickly. Therefore, deactivate the cooling with air-dehumidification function only briefly.

For vehicles with a combustion engine, the "Cooling with air dehumidification" function is available when the engine is running. For hybrid vehicles, the "Cooling with air dehumidification" function is also available via the electric refrigerant compressor when the engine is not running. The air inside the vehicle is cooled and dehumidified according to the temperature selected.

Condensation may drip from the underside of the vehicle when it is in cooling mode. This is normal and not a sign that there is a malfunction.

### Switching on/off

- ▶ **To activate:** press the  rocker switch up or down.  
The indicator lamp above the rocker switch lights up.
- or
- ▶ Activate the "Cooling with air dehumidification" function via the multimedia system (see the separate operating instructions).
- ▶ **To deactivate:** press the  rocker switch up or down.  
The indicator lamp above the rocker switch goes out.
- or
- ▶ Deactivate the "Cooling with air dehumidification" function via the multimedia system (see the separate operating instructions).

## Problems with the "Cooling with air dehumidification" function

Problem	Possible causes/consequences and ► Solutions
The indicator lamp in the  button flashes three times or remains off. Cooling with air dehumidification can also no longer be activated using the multimedia system (see the separate operating instructions).	Cooling with air dehumidification has been deactivated due to a malfunction. ► Visit a qualified specialist workshop.

### Setting climate control to automatic

#### General notes

In automatic mode, the set temperature is maintained automatically at a constant level. The system automatically regulates the temperature of the dispensed air, the airflow and the air distribution.

The "Cooling with air dehumidification" function is activated automatically in automatic mode.

#### Controlling front climate control automatically using the front control panel

► Turn the SmartKey to position **2** in the ignition lock (▷ page 162).

► Set the desired temperature using the  rocker switch on the front control unit.

or

► Set the desired temperature using the multimedia system (see the separate operating instructions).

► **To activate:** press rocker switch  up or down.

The indicator lamp in the  rocker switch lights up.



► **To switch to manual operation:** press the  rocker switch up or down.

or

► Set the airflow using the multimedia system (see the separate operating instructions).

or

► Set the airflow using the multimedia system (see the separate operating instructions).  
The indicator lamp in the  rocker switch goes out.

In automatic mode, if you adjust the airflow or air distribution manually, the indicator lamp on the  rocker switch goes out. The function which has not been changed manually, however, continues to be controlled automatically. When the manually set function switches back to automatic mode, the indicator lamp on the  rocker switch lights up again.

#### Controlling rear-compartment climate control automatically using the front control panel

Observe the notes on controlling the rear-compartment climate control using the front control panel (▷ page 145).

► Turn the SmartKey to position **2** in the ignition lock (▷ page 162).

► Press the  or  rocker switch up or down.

The climate control menu opens.

► Select "Rear adjustment" in the air-conditioning setting bar (see the separate operating instructions).

You can control the rear-compartment climate control using the front control panel or the multimedia system.

► Set the desired temperature using the  rocker switch on the front control unit.

or

► Set the desired temperature using the multimedia system (see the separate operating instructions).

► **To switch on:** press the **AUTO** rocker switch on the front control unit up or down.

or

► Activate automatic mode via the air-conditioning setting bar in the multimedia system (see the separate operating instructions). The indicator lamp in the **AUTO** rocker switch lights up.

**i** Select the temperature and automatic mode immediately thereafter. Otherwise, you will have to select "Rear adjustment" again from the air-conditioning setting bar before activating automatic mode.

► **To switch to manual operation:** press the **MENU** or **MENU REST** rocker switch up or down. The climate control menu opens.

► Select "Rear adjustment" in the air-conditioning setting bar (see the separate operating instructions).

► Use the air-conditioning setting bar to deactivate automatic mode.

or

► Set the air distribution using rocker switch **(3)** or **(7)** on the rear control panel (▷ page 141).

or

► Set the airflow using rocker switch **(5)** on the rear control panel (▷ page 141). The **AUTO** indicator on the rear display goes out.

If you adjust the rear airflow or air distribution manually using the multimedia system when in automatic mode, the **AUTO** indicator on the rear display goes out. The function which has not been changed manually, however, continues to be controlled automatically. When the manually set function switches back to automatic mode, the **AUTO** display reappears in the rear-compartment display.

### Controlling rear climate control automatically using the rear control panel

► Turn the SmartKey to position **2** in the ignition lock (▷ page 162).

► Set the desired temperature using rocker switches **(12)** and **(18)** (▷ page 141).

► **To activate:** press rocker switch **(14)** up or down (▷ page 141).

The indicator lamp in rocker switch **(14)** lights up.

► **To deactivate:** press rocker switch **(14)** up or down (▷ page 141).

The indicator lamp in rocker switch **(14)** goes out.

If you adjust the airflow or air distribution manually when in automatic mode, the **AUTO** display in the rear-compartment display goes out. The function which has not been changed manually, however, continues to be controlled automatically. When the manually set function switches back to automatic mode, the **AUTO** display reappears in the rear-compartment display.

### Adjusting the climate mode settings

In automatic mode you can select the following airflow settings for the driver's and front-passenger areas:

- FOCUS high airflow, slightly cooler setting
- MEDIUM medium airflow, standard setting
- DIFFUSE low airflow, slightly warmer and draft-free setting

► **To set:** set the climate mode using the multimedia system (see the separate operating instructions).

### Setting the temperature

#### General notes

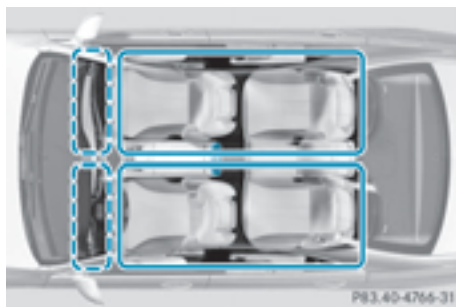

You can set the temperature separately for the following areas on vehicles without rear-compartment climate control:

- front footwells, left and right
- driver and front passenger area

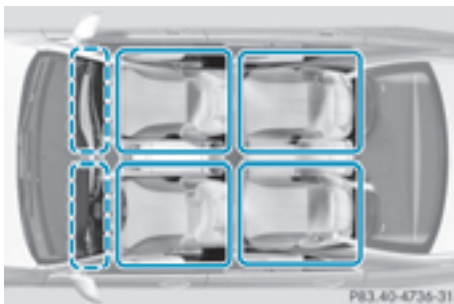

You can set the temperature separately for the following areas on vehicles with rear-compartment climate control:

- front footwells, left and right
- driver and front passenger area
- rear compartment, left and right

### Setting the temperature in the front compartment using the front control panel

- ▶ Turn the SmartKey to position **2** in the ignition lock (▷ page 162).
- ▶ **To increase or reduce:** press the rocker switch up or down.

or

- ▶ Set the temperature using the multimedia system (see the separate operating instructions).  
Only change the temperature setting in small increments. Start at 72 °F (22 °C).

### Setting the temperature in the rear compartment using the front control panel

Observe the notes on controlling the rear-compartment climate control using the front control panel (▷ page 145).

- ▶ Turn the SmartKey to position **2** in the ignition lock (▷ page 162).
- ▶ Press the or rocker switch up or down.  
The climate control menu opens.
- ▶ Select "Rear adjustment" in the air-conditioning setting bar (see the separate operating instructions).  
You can control the rear-compartment climate control using the front control panel or the multimedia system.
- ▶ **To increase or reduce:** press the rocker switch up or down on the front control panel.

or

- ▶ Set the temperature using the multimedia system (see the separate operating instructions).  
Only change the temperature setting in small increments. Start at 72 °F (22 °C).

### Setting the temperature in the rear compartment using the rear control panel

- ▶ Turn the SmartKey to position **2** in the ignition lock (▷ page 162).
- ▶ **To increase or reduce:** press rocker switch or up or down (▷ page 141).  
Only change the temperature setting in small increments. Start at 72 °F (22 °C).

### Setting the footwell temperature

The footwell temperature for the driver and front passenger can be set separately using the multimedia system (see the separate operating instructions).

### Setting the air distribution

#### Air distribution settings

- Directs air through the defroster vents
- Directs air through the center and side air vents
- Directs air through the footwell air vents
- Directs air through the center, side and footwell vents



 Directs air through the defroster and footwell vents

 Sets the air distribution to automatic

### Setting the air distribution in the front/rear compartments using the multimedia system

The air distribution for the left and right sides of the front and rear compartment can be adjusted using the multimedia system (see the separate operating instructions).

### Setting the air distribution in the rear compartment using the rear control panel

- ▶ Turn the SmartKey to position **2** in the ignition lock (▷ page 162).
- ▶ Press rocker switch  or  up or down repeatedly (▷ page 141) until the desired air distribution symbol is shown in the display.

### Setting the airflow

#### General notes

You can select different airflow settings for the driver's and front-passenger sides as well as for the rear compartment (only vehicles with rear compartment climate control).

Observe the notes on controlling the rear-compartment climate control using the front control panel (▷ page 145).



### Setting the front-compartment airflow using the front control panel

- ▶ Turn the SmartKey to position **2** in the ignition lock (▷ page 162).
- ▶ **To increase or reduce:** press the  rocker switch up or down.

or

- ▶ Set the airflow using the multimedia system (see the separate operating instructions).

### Setting the rear-compartment airflow using the front control panel

- ▶ Turn the SmartKey to position **2** in the ignition lock (▷ page 162).
- ▶ Press the  or  rocker switch up or down.  
The climate control menu opens.
- ▶ Select "Rear adjustment" in the air-conditioning setting bar (see the separate operating instructions).  
You can control the rear-compartment climate control using the front control panel or via the multimedia system.
- ▶ **To increase or reduce:** press the  rocker switch up or down on the front control panel.

or

- ▶ Set the airflow using the multimedia system (see the separate operating instructions).

### Setting the rear compartment airflow using the rear control panel

- ▶ Turn the SmartKey to position **2** in the ignition lock (▷ page 162).
- ▶ **To increase or reduce:** press rocker switch  up or down (▷ page 141).

### Activating or deactivating the synchronization function

Climate control can be set centrally using the synchronization function. The settings for temperature, air distribution and airflow on the driver's side are adopted for the front-passenger side and the rear compartment (vehicles with rear-compartment air conditioning).

- ▶ **To activate or deactivate:** activate or deactivate the synchronization function using the multimedia system (see the separate operating instructions).  
Vehicles with rear-compartment air conditioning: the **SYNC** display appears on the rear-compartment display.

The synchronization function is deactivated:

- if the settings for the front-passenger side are changed
- vehicles with rear-compartment air conditioning: the settings for the rear compartment are changed





## Defrosting the windshield

You can use this function to defrost the windshield or to clear a fogged up windshield or front side windows on the inside.

Switch off the "Windshield defrosting" function as soon as the windshield is clear again.

► Turn the SmartKey to position **2** in the ignition lock (▷ page 162).

► **To switch on:** press the  rocker switch on the front control unit up or down. The indicator lamp in the  rocker switch lights up.

The climate control system switches to the following functions:

- high airflow
- high temperature
- air distribution to the windshield and front side windows
- air-recirculation mode off
- windshield heating on
- cooling with air dehumidification

► **To deactivate:** press the  rocker switch up or down.

The indicator lamp in the  rocker switch goes out. The previously selected settings are restored. Air-recirculation mode remains deactivated.

or

► Press the  rocker switch up or down.

or

► Use the  or  rocker switch to call up the multimedia system climate control menu.

## Defrosting the windows

### Windows fogged up on the inside

► Activate the "Cooling with air dehumidification" function with the  rocker switch.

or

► Activate the "Cooling with air dehumidification" function via the multimedia system (see the separate operating instructions).

► Switch on automatic mode using the  rocker switch.

► If the windows continue to fog up, activate the "Windshield defrosting" function using the

 rocker switch. The windshield heating is switched on.

**i** You should only select this setting until the windshield is clear again.

### Windows fogged up on the outside

► Activate the windshield wipers.

► Switch on automatic mode using the  rocker switch.

**i** If you clean the windows regularly, they do not fog up so quickly.

## Rear window defroster



### General notes

The rear window defroster has a high current draw. You should therefore switch it off as soon as the rear window is clear. Otherwise, the rear window defroster switches off automatically after several minutes.

If the battery voltage is too low, the rear window defroster may switch off.

### Activating or deactivating

► Turn the SmartKey to position **2** in the ignition lock (▷ page 162).

► Press the  rocker switch up or down. The indicator lamp in the  rocker switch lights up or goes out.

## Problems with the rear window defroster

Problem	Possible causes/consequences and ► Solutions
The rear window defroster has deactivated prematurely or cannot be activated.	<p>The battery has not been sufficiently charged.</p> <p>► Switch off any consumers that are not required, e.g. reading lamps, interior lighting or the seat heating.</p> <p>When the battery is sufficiently charged, the rear window defroster can be activated again.</p>

### Switching air-recirculation mode on/off



#### General notes

You can also temporarily deactivate the flow of fresh air manually if unpleasant odors are entering the vehicle from outside. The air already inside the vehicle will then be recirculated.

If you switch on air-recirculation mode, the windows can fog up more quickly, in particular at low temperatures. Only use air-recirculation mode briefly to prevent the windows from fogging up.

#### Activating/deactivating



► Turn the SmartKey to position **2** in the ignition lock (► page 162).

► **To activate:** press the  rocker switch up or down.  
The indicator lamp in the  rocker switch lights up.

Air-recirculation mode switches on automatically:

- at high outside temperatures
- at high levels of pollution
- in a tunnel

The indicator lamp in the  rocker switch is not lit when automatic air-recirculation mode is activated. Outside air is added after about 30 minutes.

► **To deactivate:** press the  rocker switch up or down.  
The indicator lamp in the  rocker switch goes out.

Air-recirculation mode deactivates automatically:

- after approximately five minutes at outside temperatures below approximately 41 °F (5 °C)
- after approximately five minutes if cooling with air dehumidification is deactivated
- after approximately 30 minutes at outside temperatures above approximately 41 °F (5 °C) if the "Cooling with air dehumidification" function is activated

### Switching the residual heat on or off





#### General notes

**Vehicles with rear-compartment climate control:** once the engine is switched off, it is possible to make use of the residual heat of the engine to continue heating or ventilating the rear and front compartment of the vehicle for approximately 15 minutes. If the "Residual heat" function is set for only the front or only the rear compartment, it is possible to continue heating or ventilating for approximately 30 minutes.

**Vehicles without rear-compartment climate control:** once the engine is switched off, it is possible to make use of the residual heat of the engine to continue heating or ventilating the front compartment of the vehicle for approximately 30 minutes.





The heating or ventilation time depends on the temperature that has been set.

### Front control panel





- ▶ Turn the SmartKey to position **0** in the ignition lock or remove it (▷ page 162).
- ▶ **To activate:** press the  or  rocker switch up or down. The indicator lamp in the  or  rocker switch lights up.

The blower will run at a low speed regardless of the airflow setting.

If you activate the residual heat function at high temperatures, only the ventilation will be activated. The blower runs at medium speed.

- ▶ **To deactivate:** press the  or  rocker switch up or down. The indicator lamp in the  or  rocker switch goes out.

### Rear control panel

- ▶ Turn the SmartKey to position **0** in the ignition lock or remove it (▷ page 162). The **REST** display appears on the rear compartment display.
- ▶ **To activate:** press rocker switch  up or down (▷ page 141). The indicator lamp in rocker switch  lights up.
- ▶ **To deactivate:** press rocker switch  up or down (▷ page 141). The indicator lamp in rocker switch  goes out. **REST** goes out on the rear compartment display.

 If you do not activate the residual heat function, **REST** goes out automatically after five minutes on the rear compartment display.

Residual heat is deactivated automatically:

- after approximately 30 minutes if the residual heat function is activated in the front or rear compartment
- after approximately 15 minutes if the residual heat function is activated in the front and rear compartments
- when the ignition is switched on
- if the battery voltage drops

### Perfume atomizer

#### Operating the perfume atomizer

##### **WARNING**

If children open the vial, they could drink the perfume or it could come into contact with their eyes. There is a risk of injury. Do not leave children unsupervised in the vehicle.

If the perfume liquid has been drunk, consult a doctor. If perfume comes into contact with your eyes or skin, rinse the eyes with clean water. If you continue to experience difficulties, consult a doctor.

##### **Environmental note**



Full vials must not be disposed of with household waste. They must be collected separately and recycled to protect the environment.



Dispose of full vials in an environmentally responsible manner and take them to a harmful substance collection point.

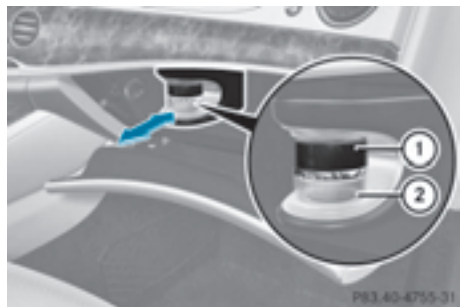

- ① Vial lid
- ② Vial

The perfume atomizer helps to improve driving comfort.

Via the multimedia system you can:

- switch the perfume atomizer on or off
- regulate the perfume intensity (see the separate operating instructions)

The following conditions can affect your perception of the perfume intensity:

- operating mode of the climate control system
- interior temperature
- time of year or day
- air humidity
- physiological condition of occupants, e.g. fatigue or hunger

The perfume atomizer can only be operated when the climate control system is switched on and is only active when the glove box is closed.

The perfume atomizer is provided with a pre-filled vial. You can also choose from a variety of filled perfume vials and an empty vial which you can fill yourself.

If you refill an empty perfume vial, observe the separate information sheet attached to the vial.

**!** If you do not use genuine Mercedes-Benz interior perfumes, observe the manufacturers' safety notices on the perfume packaging.

Do not refill the pre-filled perfume vial when it is empty. Dispose of the used vial after use.

- ▶ **To insert the perfume vial:** open the glove box (▷ page 326).
- ▶ Slide the perfume vial into the holder as far as it will go.
- ▶ **To remove the perfume vial:** pull out the perfume vial.
- ▶ **To refill the perfume vial:** unscrew the lid of the empty perfume vial to refill it yourself.
- ▶ Fill the perfume vial with a maximum of 0.5 fl. oz. (15 ml) of the desired liquid perfume.
- ▶ Screw the lid back on to the vial.

**!** Only refill the vial when you are outside the vehicle. Otherwise, liquid perfume could drip into the interior and contaminate it.

Always refill the empty refillable vial with the same perfume. Otherwise, you might not achieve optimum results from the perfume atomizer.

## Problems with the perfume atomizer

Problem	Possible causes/consequences and ► Solutions
The vehicle interior is not perfumed although the perfume atomizer is activated.	The perfume vial has not been pushed into the holder as far as it will go. ► Slide the perfume vial into the holder as far as it will go.
	The perfume vial is not filled sufficiently. ► <b>Pre-filled vials:</b> dispose of the empty vial. ► Use a new pre-filled vial. ► <b>Refillable vials:</b> fill the perfume vial with a maximum of 0.5 fl. oz. (15 ml) of the same perfume.
	The perfume atomizer is faulty. ► Have the perfume atomizer checked at a qualified specialist workshop.

### Ionization

You can use the "Ionization" function to purify the air in the vehicle interior and attain an improved interior climate.

The ionization of the interior air is odorless and cannot be perceived directly in the vehicle interior.

You can switch ionization on or off using the multimedia system (see the separate operating instructions).

Ionization can only be switched on if the front climate control system is activated. The side air vent on the driver's side must be open.

### Pre-entry climate control via SmartKey

#### General notes

The "Pre-entry climate control via SmartKey" function is only available in PLUG-IN HYBRID vehicles.

Before getting in, the driver's seat area or the whole interior can be briefly warmed or ventilated in advance with the air from the air vents being pre-cooled.

The high-voltage battery must be sufficiently charged before "Pre-entry climate control via SmartKey" can be activated.

When the vehicle is pre-cooled, the following functions are activated if required:

- Climate control system
- Blower
- Seat ventilation

When the vehicle is pre-heated, the following functions are activated if required:

- Climate control system
- Blower
- Seat heating
- Steering wheel heating
- Exterior mirror heating
- Rear window defroster

If you have activated the following functions using the multimedia system, they are activated together with the "Pre-entry climate control via SmartKey" function:

- Armrest heating
- Perfume atomizer
- Ionization

Activating the perfume atomizer or ionization (see separate operating instructions).

#### Activating or deactivating "Pre-entry climate control via SmartKey"

Before "Pre-entry climate control via SmartKey" can be activated, you must activate the function via the multimedia system (see separate operating instructions).

► **To activate pre-entry climate control via SmartKey:** unlock the vehicle with the SmartKey or KEYLESS-GO.

The climate control functions are activated for up to 5 minutes for pre-heating and pre-cooling.

**To deactivate "Pre-entry climate control via SmartKey":** "Pre-entry climate control via SmartKey" switches off automatically when the engine is started.

The following functions remain active after the engine is started:

- Seat heating (heating)
- Seat ventilation (ventilation)
- Armrest heating
- Perfume atomizer
- Ionization

An activated "Pre-entry climate control via SmartKey" function can be deactivated using the rocker switch (► page 158).

## Problems with "Pre-entry climate control via SmartKey"

Problem	Possible causes/consequences and ► Solutions
<p>"Pre-entry climate control via SmartKey" cannot be switched on or has switched itself off.</p>	<p>The condition of charge of the high-voltage battery is under the specified minimum condition of charge.</p> <p>► Start the engine when the vehicle is at a standstill. The engine powers the electric motor. The electric motor operates as a generator. The high-voltage battery is being charged.</p> <p>Further information on charging the high-voltage battery via:</p> <ul style="list-style-type: none"> <li>• a mains socket (&gt; page 183)</li> <li>• a charging station (&gt; page 186)</li> <li>• a wallbox (&gt; page 185)</li> </ul>
	<p>"Pre-entry climate control via SmartKey" has been started more than twice with the engine switched off.</p> <p>► Switch on the engine and let it run for more than ten seconds.</p> <p>► Try again to switch on "Pre-entry climate control via SmartKey".</p>

### Pre-entry climate control at time of departure

#### Important safety notes

 **WARNING**

If persons, particularly children are subjected to prolonged exposure to extreme heat or cold, there is a risk of injury, possibly even fatal. Never leave children unattended in the vehicle.

#### General notes

The "Pre-entry climate control at departure time" function is only available in PLUG-IN HYBRID vehicles.

You can use the "Pre-entry climate control at departure time" function to cool or heat the vehicle interior if the engine is not running.

The "Pre-entry climate control at departure time" function can be activated regardless of whether or not the vehicle is connected to an electric power supply. The condition of charge of the high-voltage battery must be higher than the specified minimum condition of charge, however.

When the vehicle is connected to an electric power supply, priority is given to charging the high-voltage battery to the specified minimum

charge. "Pre-entry climate control at departure time" is only activated subsequently.

The running time of the "Pre-entry climate control at departure time" function may be reduced if:

- the vehicle is not connected to an electric power supply and
  - the high-voltage battery is not fully charged
- With active "Pre-entry climate control at departure time" the condition of charge of the high-voltage battery can be reduced, even if the charge cable connector is connected.

When the vehicle is cooled, the following functions are activated if required:

- Climate control system
- Blower
- Seat ventilation

When the vehicle is heated, the following functions are activated if required:

- Climate control system
- Blower
- Seat heating
- Steering wheel heating
- Armrest heating
- Exterior mirror heating
- Rear window defroster

If you have switched on the perfume atomizer or the ionization using the multimedia system,

these will be activated together with the "Pre-entry climate control at departure time".

Activating the perfume atomizer or ionization (see separate operating instructions).

### Setting the departure time

You can set the departure time using the on-board computer or via the My Mercedes Electric – Vehicle Homepage. The activation of the "Pre-entry climate control at departure time" function can be linked to this departure time. Your vehicle will then be cooled or heated until the desired temperature is reached in time for the set departure time. "Pre-entry climate control at departure time" will be activated a maximum of 55 minutes before departure. If the departure is delayed, the vehicle will be heated or cooled for another five minutes.

- ▶ **To set the departure time:** set the departure time using the on-board computer (▷ page 272). Set the departure time via the My Mercedes Electric – Vehicle Homepage (▷ page 189).
- ▶ **To activate or deactivate "Pre-entry climate control at departure time":** activate or deactivate "Pre-entry climate control at departure time" via the multimedia system (see the separate operating instructions). Activate or deactivate "Pre-entry climate control at departure time" via the My Mercedes Electric – Vehicle Homepage (▷ page 189).

When activating the "Pre-entry climate control at departure time" function: you can select whether only the driver's area or the whole vehicle interior should be heated or cooled.

The "Pre-entry climate control at departure time" function switches off automatically when the vehicle is started. The following functions remain active:

- Seat heating
- Seat ventilation
- Armrest heating
- Steering wheel heating
- Perfume atomizer
- Ionization

**Switching off "Pre-entry climate control at departure time":** the activated "Pre-entry climate control at departure time" can be switched off using the rocker switch (▷ page 158).

### Activating or deactivating "Immediate pre-entry climate control" using the rocker switch

You can activate "Immediate pre-entry climate control" even if the vehicle interior is already at the desired temperature. This means that the vehicle interior continues to be cooled or heated, e.g. if the journey is interrupted for up to 50 minutes, and the interior temperature is kept constant.



- ▶ **To activate or deactivate "Immediate pre-entry climate control":** press rocker switch ① up or down. The blue or red indicator lamp on the rocker switch lights up or goes out.

The colors of the indicator lamps on rocker switch ① have the following meanings:

- blue: cooling activated
- red: heating activated
- yellow: departure time is preselected

### Setting the air vents

#### Important safety notes

##### WARNING

Very hot or very cold air can flow from the air vents. This could result in burns or frostbite in the immediate vicinity of the air vents. There is a risk of injury.

Make sure that all vehicle occupants always maintain a sufficient distance to the air outlets. If necessary, redirect the airflow to another area of the vehicle interior.



In order to ensure the direct flow of fresh air through the air vents into the vehicle interior, please observe the following notes:

- keep the air inlet between the windshield and the hood free of blockages, such as ice, snow or leaves.
- never cover the air vents or air intake grilles in the vehicle interior.

### Setting the center air vents

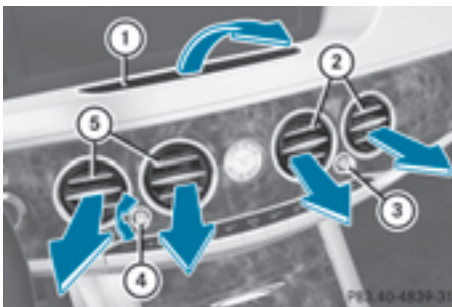

- ① Fixed center air vent
- ② Center air vent, right
- ③ Center vent control, right
- ④ Center vent control, left
- ⑤ Center air vent, left

- ▶ **To open/close:** press control ③ or ④. The control pops out.
- ▶ Turn control ③ or ④ counter-clockwise or clockwise.
- ▶ **To adjust the air direction:** hold rear air vent ② or ⑤ by the middle fin and move up or down or to the left or right.

### Setting the side air vents

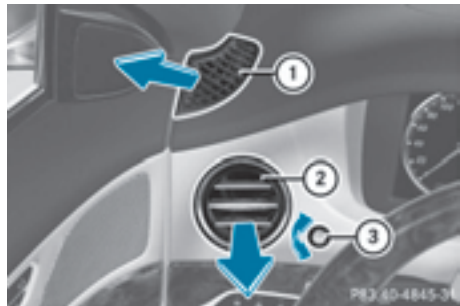

- ① Side window defroster vent
- ② Side air vent
- ③ Control for left side air vent

- ▶ **To open/close:** press control ③. The control pops out.
- ▶ Turn control ③ counter-clockwise or clockwise.
- ▶ **To adjust the air direction:** hold side air vent ② by the middle fin and move it up or down or to the left or right.

### Setting the glove box air vent

- ❗ Close the air vent when heating the vehicle. At high outside temperatures, open the air vent and activate the "cooling with air dehumidification" function. Otherwise, temperature-sensitive items stored in the glove box could be damaged.

When the climate control system is activated, the glove box can be ventilated, for instance to cool its contents. The level of airflow depends on the airflow and air distribution settings.

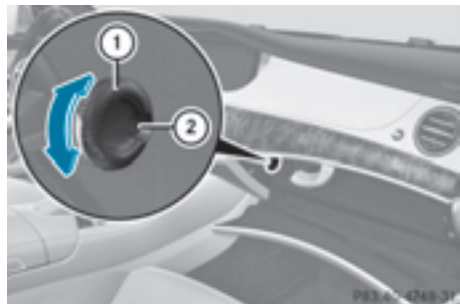

- ① Air vent control
- ② Air vent

- ▶ **To open or close:** turn control ① to the right or left.

### Setting the rear-compartment air vents

#### Setting the center vents in the rear compartment

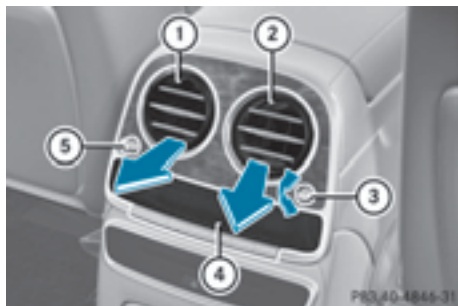

- ① Rear-compartment air vent, left
- ② Rear-compartment air vent, right
- ③ Rear-compartment air vent control, right
- ④ Rear control panel (only vehicles with rear-compartment climate control)
- ⑤ Rear-compartment air vent control, left

- ▶ **To open/close:** press control ③ or ⑤. The control pops out.
- ▶ Turn control ③ or ⑤ counter-clockwise or clockwise.
- ▶ **To adjust the air direction:** hold the rear air vent ① or ② by the middle fin and move up or down or to the left or right.

#### Setting the B-pillar air vent



- ▶ **To open or close:** turn thumbwheel ② to the left or right.
- ▶ **To adjust the air direction:** hold B-pillar air vent ① by the middle fin handle and move up or down or to the left or right.

## Useful information

- i** This Operator's Manual describes all models and all standard and optional equipment of your vehicle available at the time of publication of the Operator's Manual. Country-specific differences are possible. Please note that your vehicle may not be equipped with all features described. This also applies to safety-related systems and functions.
- i** Read the information on qualified specialist workshops (▷ page 28).

## Notes on breaking-in a new vehicle

### Important safety notes

The sensor system of some driving and driving safety systems adjusts automatically while a certain distance is being driven after the vehicle has been delivered or after repairs. Full system effectiveness is not reached until the end of this teach-in procedure.

New and replaced brake pads and discs only reach their optimum braking effect after several hundred kilometers of driving. Compensate for this by applying greater force to the brake pedal.

### The first 1000 miles (1500 km)

The more you look after the engine when it is new, the more satisfied you will be with its performance in the future.

- You should therefore drive at varying vehicle and engine speeds for the first 1000 miles (1500 km).
- Avoid heavy loads, e.g. driving at full throttle, during this period.
- When shifting gears manually, upshift in good time, before the tachometer needle reaches  $\frac{2}{3}$  of the way to the red area of the tachometer.
- Do not manually shift to a lower gear to brake the vehicle.
- Try to avoid depressing the accelerator pedal beyond the point of resistance (kickdown).
- **All vehicles (except Mercedes-AMG vehicles):** ideally, for the first 1,000 miles (1,500 km), drive in drive program **E**.

Additional breaking-in notes for Mercedes-AMG vehicles:

- Do not drive faster than 85 mph (140 km/h) for the first 1,000 miles (1,500 km).
- Only allow the engine to reach a maximum engine speed of 4,500 rpm briefly.
- Change gear in good time.
- Ideally, for the first 1,000 miles (1,500 km), drive in program **C**.

After 1000 miles (1500 km), you can increase the engine speed gradually and accelerate the vehicle to full speed.

You should also observe these notes on breaking in if the engine or parts of the drive train on your vehicle have been replaced.

Always observe the maximum permissible speed.

## Driving

### Important safety notes

#### WARNING

Objects in the driver's footwell can restrict the pedal travel or obstruct a depressed pedal. The operating and road safety of the vehicle is jeopardized. There is a risk of an accident.

Make sure that all objects in the vehicle are stowed correctly, and that they cannot enter the driver's footwell. Install the floor mats securely and as specified in order to ensure sufficient clearance for the pedals. Do not use loose floor mats and do not place floor mats on top of one another.

#### WARNING

Unsuitable footwear can hinder correct usage of the pedals, e.g.:

- shoes with thick soles
- shoes with high heels
- slippers

There is a risk of an accident.

Wear suitable footwear to ensure correct usage of the pedals.

**⚠ WARNING**

If you switch off the ignition while driving, safety-relevant functions are only available with limitations, or not at all. This could affect, for example, the power steering and the brake boosting effect. You will require considerably more effort to steer and brake. There is a risk of an accident.

Do not switch off the ignition while driving.

**⚠ WARNING**

If the parking brake has not been fully released when driving, the parking brake can:

- overheat and cause a fire
- lose its hold function.

There is a risk of fire and an accident. Release the parking brake fully before driving off.

**!** Do not warm up the engine with the vehicle stationary. Drive off immediately. Avoid high engine speeds and driving at full throttle until the engine has reached its operating temperature.

Only shift the automatic transmission to the desired drive position when the vehicle is stationary.

Where possible, avoid spinning the drive wheels when pulling away on slippery roads. You could otherwise damage the drive train.

**!** **Mercedes-AMG vehicles:** at low engine oil temperatures below 68 °F (+20 °C), the maximum engine speed is restricted in order to protect the engine. To protect the engine and maintain smooth engine operation, avoid driving at full throttle when the engine is cold.

Observe the important safety notes for PLUG-IN HYBRID vehicles (> page 42).

**SmartKey positions****SmartKey**

- 0** To remove the SmartKey
- 1** Power supply for some consumers, such as the windshield wipers
- 2** Ignition (power supply for all consumers) and drive position
- 3** To start the engine

The SmartKey can be turned in the ignition lock even if it is not the correct SmartKey for the vehicle. The ignition is not switched on. The engine cannot be started.

**Start/Stop button****General notes**

All vehicles are equipped with a removable Start/Stop button.

The Start/Stop button must be inserted in the ignition lock and the Smartkey must be in the vehicle.

When you insert the Start/Stop button into the ignition lock, the system needs approximately two seconds recognition time. You can then use the Start/Stop button.

Pressing the Start/Stop button several times in succession corresponds to the different key positions in the ignition lock. This is only the case if you are not depressing the brake pedal.

If you depress the brake pedal and press the Start/Stop button, the engine starts immediately.

A check which periodically establishes a radio connection between the vehicle and the SmartKey determines whether a valid SmartKey is in the vehicle. This occurs, for example, when starting the engine.

To start the vehicle without actively using the Smartkey:

- the Start/Stop button must be inserted in the ignition lock.
- the Smartkey must be in the vehicle.
- the vehicle must not be locked with the SmartKey or KEYLESS-GO (▷ page 80).

Do not keep the SmartKey:

- with electronic devices, e.g. a mobile phone or another SmartKey.
- with metallic objects, e.g. coins or metal foil.
- inside metallic objects, e.g. a metal case.

This can affect the functionality of the SmartKey.

Do not keep the SmartKey in the temperature-controlled cup holder (▷ page 332). Otherwise, the key will not be detected, e.g. when starting the engine with the Start/Stop button.

If you lock the vehicle with the SmartKey's remote control or with KEYLESS-GO, after a short time:

- you will not be able to switch on the ignition with the Start/Stop button.
- you will not be able to start the engine with the Start/Stop button until the vehicle is unlocked again.

If you lock the vehicle centrally using the button on the front door (▷ page 86), you can continue to start the engine with the Start/Stop button.

The engine can be switched off while the vehicle is in motion by pressing and holding the Start/Stop button for three seconds. This function operates independently of the ECO start/stop automatic engine switch-off function.

### Key positions with the Start/Stop button



- ① Start/Stop button  
② Ignition lock

As soon as the ignition is switched on, all the indicator lamps in the instrument cluster light up. Further information on situations where an indicator lamp either fails to go out after starting the engine or lights up while driving (▷ page 315).

If Start/Stop button ① has not yet been pressed, this corresponds to the SmartKey being removed from the ignition.

► **To switch on the power supply:** press Start/Stop button ① once.

The power supply is switched on. You can now activate the windshield wipers, for example.

The power supply is switched off again if:

- the driver's door is opened and
- you press Start/Stop button ① twice when in this position

► **To switch on the ignition:** press Start/Stop button ① twice.

The ignition is switched on.

The ignition is switched off again if:

- you do not start the engine within 15 minutes when in this position
- you press Start/Stop button ① twice when in this position.

The power supply is switched off again if:

- the driver's door is opened and
- you press Start/Stop button ① twice when in this position

### Removing the Start/Stop button

You can remove the Start/Stop button from the ignition lock and start the vehicle as normal using the Smartkey.

It is only possible to switch between Start/Stop button mode and Smartkey operation when the transmission is in position **P**.

► Remove Start/Stop button ① from ignition lock ②.

You do not have to remove the Start/Stop button from the ignition lock when you leave the vehicle. You should, however, always take the Smartkey with you when leaving the vehicle. As long as the Smartkey is in the vehicle:

- the vehicle can be started using the Start/Stop button
- the electrically powered equipment can be operated

## Starting the engine

### Important safety notes

#### WARNING

If children are left unsupervised in the vehicle, they could:

- open the doors, thus endangering other people or road users.
- get out and disrupt traffic.
- operate the vehicle's equipment.

Additionally, children could set the vehicle in motion if, for example, they:

- release the parking brake.
- shifting the automatic transmission out of park position **P**
- Start the engine.

There is a risk of an accident and injury.

When leaving the vehicle, always take the SmartKey with you and lock the vehicle. Never leave children or animals unattended in the vehicle. Always keep the SmartKey out of reach of children.

#### WARNING

Combustion engines emit poisonous exhaust gases such as carbon monoxide. Inhaling these exhaust gases leads to poisoning. There is a risk of fatal injury. Therefore never leave the engine running in enclosed spaces without sufficient ventilation.

#### WARNING

Flammable materials introduced through environmental influence or by animals can ignite if in contact with the exhaust system or parts of the engine that heat up. There is a risk of fire.

Carry out regular checks to make sure that there are no flammable foreign materials in the engine compartment or in the exhaust system.

## General notes

During a cold start, the engine runs at higher speeds to enable the catalytic converter to reach its operating temperature. The sound of the engine may change during this time.

## Automatic transmission

- ▶ Shift the transmission to position **P** (▷ page 170).  
The transmission position display in the multifunction display shows **P** (▷ page 172).

You can start the engine in transmission position **P** and **N**.

## Starting procedure with the SmartKey

To start the engine using the SmartKey instead of the Start/Stop button, pull the Start/Stop button out of the ignition lock.

- ▶ Turn the SmartKey to position **3** in the ignition lock and release it as soon as the engine is running (▷ page 162).

## Starting procedure with the Start/Stop button

The Start/Stop button can be used to start the vehicle manually without inserting the SmartKey into the ignition lock. The Start/Stop button must be inserted in the ignition lock and the SmartKey must be in the vehicle. This mode for starting the engine operates independently of the ECO start/stop automatic engine start function.

You can start the engine if a valid SmartKey is in the vehicle. Always take the SmartKey with you when leaving the vehicle, even if you only leave it for a short time. Pay attention to the important safety notes.

- ▶ Depress the brake pedal and keep it depressed.
- ▶ Press the Start/Stop button once (▷ page 162).  
The engine starts.

## Starting procedure via smartphone

Observe the important safety notes on starting the engine (▷ page 164).

You can also start your engine via your smartphone from outside the vehicle. In this case, the

previously selected climate control setting is activated. In this way you can cool or heat the interior of the vehicle before starting the journey.

Only start the engine via your smartphone if it is safe to start and run the engine where your vehicle is parked.

Observe the legal stipulations in the area where your vehicle is parked. Engine start via smartphone may be limited to certain countries or regions.

You can execute a maximum of two consecutive starting attempts via your smartphone. If you insert the SmartKey into the ignition lock, you can carry out two more starting attempts.

Once you have started the engine, you can switch the engine off via your smartphone at any time.

You can only start the engine via your smartphone if:

- the SmartKey is in the ignition lock
- park position **P** is selected
- the accelerator pedal is not depressed
- the anti-theft alarm system is not activated
- the panic alarm is not activated
- the hazard warning lamps are switched off
- the hood is closed.
- the doors are closed and locked
- the windows and sliding sunroof are closed

Also make sure that:

- the fuel tank is sufficiently filled
- the starter battery is sufficiently charged

### WARNING

Limbs could be crushed or trapped if the engine is started unintentionally during service or maintenance work. There is a risk of injury.

Always secure the engine against unintentional starting before carrying out maintenance or repair work.

Make sure that the engine cannot be started via your smartphone before carrying out maintenance or repairs. You can prevent an engine start via your smartphone, for example, if you:

- switch on the hazard warning lamps
- do not lock the doors
- open the hood

## Pulling away

### General notes

#### WARNING

If the engine speed is above the idling speed and you engage transmission position **D** or **R**, the vehicle could pull away suddenly. There is a risk of an accident.

When engaging transmission position **D** or **R**, always firmly depress the brake pedal and do not simultaneously accelerate.

Depress the accelerator carefully when pulling away.

The vehicle locks centrally once you have pulled away. The locking knobs in the doors drop down. You can open the doors from the inside at any time.

You can also deactivate the automatic locking feature (▷ page 87).

It is only possible to shift the transmission from position **P** to the desired position if you depress the brake pedal. Only then is the parking lock released.

If you do not depress the brake pedal, the DIRECT SELECT lever can still be moved but the parking lock remains engaged.

 Upshifts take place at higher engine speeds after a cold start. This helps the catalytic converter to reach its operating temperature more quickly.

Information on the automatic release of the electric parking brake (▷ page 191).

### Hill start assist

Hill start assist helps you when pulling away forwards or in reverse on an uphill gradient. It holds the vehicle for a short time after you have removed your foot from the brake pedal. This gives you enough time to move your foot from the brake pedal to the accelerator pedal and to depress it before the vehicle begins to roll.

#### WARNING

After a short time, hill start assist will no longer brake your vehicle and it could roll away. There is a risk of an accident and injury.

Therefore, quickly move your foot from the brake pedal to the accelerator pedal. Never leave the vehicle when it is held by hill start assist.

Hill start assist is not active if:

- you are pulling away on a level road or on a downhill gradient.
- the transmission is in position **N**.
- the electric parking brake is applied.
- ESP® is malfunctioning.

### ECO start/stop function (all vehicles except PLUG-IN HYBRID)

#### Introduction

This section describes the ECO start/stop function for all vehicles except PLUG-IN HYBRID vehicles. Information on the ECO start/stop function on PLUG-IN HYBRID vehicles (> page 252).

The ECO start/stop function switches the engine off automatically if the vehicle is stopped under certain conditions.

The engine starts automatically when the driver wants to pull away again. The ECO start/stop function thereby helps you to reduce the fuel consumption and emissions of your vehicle.

#### Important safety notes

##### WARNING

If the engine is switched off automatically and you exit the vehicle, the engine is restarted automatically. The vehicle may begin moving. There is a risk of accident and injury.

If you wish to exit the vehicle, always turn off the ignition and secure the vehicle against rolling away.

#### General notes



##### ① ECO start/stop display

The ECO start/stop function is activated whenever you switch on the engine using the Smart-Key or the Start/Stop button.

If the engine has been switched off automatically by the ECO start/stop function, the  ECO symbol is shown in the multifunction display.

The ECO start/stop function is only available in drive program **E** (drive program **C** on Mercedes-AMG vehicles).

#### Automatic engine switch-off

If the vehicle is braked to a standstill in **D** or **N**, the ECO start/stop function switches off the engine automatically.

The ECO start/stop function is operational when:

- the indicator lamp in the ECO button is lit green.
- the outside temperature is within the range that is suitable for the system.
- the engine is at normal operating temperature.
- the set temperature for the vehicle interior has been reached.
- the battery is sufficiently charged.
- the system detects that the windshield is not fogged up when the air-conditioning system is switched on.
- the hood is closed.
- the driver's door is closed and the driver's seat belt is fastened.

All of the vehicle's systems remain active when the engine is stopped automatically.

The HOLD function can be activated if the engine has been switched off automatically. It is



then not necessary to continue applying the brakes during the automatic stop phase. When you depress the accelerator pedal, the engine starts automatically and the braking effect of the HOLD function is deactivated.

**All vehicles (except Mercedes-AMG vehicles):** automatic engine switch-off can take place a maximum of four times in a row (initial stop, then three subsequent stops).

**Mercedes-AMG vehicles:** the number of consecutive automatic engine switch-offs is unlimited.

### Automatic engine start

The engine starts automatically if:

- you switch off the ECO start/stop function by pressing the ECO button
- you switch to drive program **S** or **M**
- in transmission position **D** or **N** the brake pedal is released and the HOLD function is not active
- you depress the accelerator pedal
- you engage reverse gear **R**
- you move the transmission out of position **P**
- you unfasten your seat belt or open the driver's door
- the vehicle starts to roll
- the brake system requires this
- the temperature in the vehicle interior deviates from the set range
- the system detects moisture on the windshield when the air-conditioning system is switched on
- the battery's condition of charge is too low

Shifting the transmission to position **P** does not start the engine.

### Deactivating or activating the ECO start/stop function

**All vehicles (except Mercedes-AMG vehicles)**

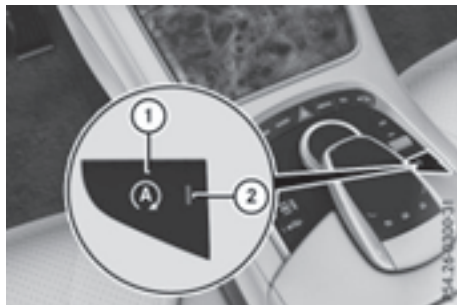

- ▶ **To deactivate:** press ECO button ①. Indicator lamp ② goes out.
- ▶ **To activate:** press ECO button ①. Indicator lamp ② lights up.

If indicator lamp ② is off, the ECO start/stop function has been deactivated manually or as the result of a malfunction. The engine will then not be switched off automatically when the vehicle stops.

If drive program **S** or **M** has been selected, the ECO start/stop function is always deactivated.

If you switch on the ECO start/stop function while drive program **S** is selected, the drive program automatically switches to **E**.

### Mercedes-AMG vehicles

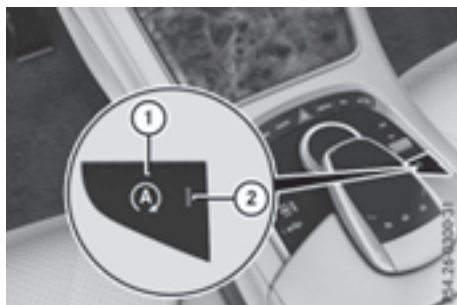

- ▶ **To deactivate:** in drive program **C**, press ECO button ①.
- or
- ▶ Switch to drive program **S** or **M** (▷ page 173). Indicator lamp ② goes out.

► **To activate:** press ECO button ①.

Indicator lamp ② lights up.

If drive program **S** or **M** is active, the automatic transmission switches to drive program **C**.

If indicator lamp ② is off, the ECO start/stop function has been deactivated manually or as the result of a malfunction. The engine will then not be switched off automatically when the vehicle stops.

If drive program **S** or **M** has been selected, the ECO start/stop function is always deactivated.

If you switch on the ECO start/stop function while drive program **S** is selected, the drive program automatically switches to **C**.

Problems with the engine	
Problem	Possible causes/consequences and ► Solutions
The engine does not start. The starter motor can be heard.	<ul style="list-style-type: none"> <li>• There is a malfunction in the engine electronics.</li> <li>• There is a malfunction in the fuel supply.</li> </ul> <p>Before attempting to start the engine again:</p> <ul style="list-style-type: none"> <li>► Turn the SmartKey back to position <b>0</b> in the ignition lock.</li> </ul> <p>or</p> <ul style="list-style-type: none"> <li>► Press the Start/Stop button repeatedly until all indicator lamps in the instrument cluster go out.</li> <li>► Try to start the engine again (► page 164). Avoid excessively long and frequent attempts to start the engine as these will drain the battery.</li> </ul> <p>If the engine does not start after several attempts:</p> <ul style="list-style-type: none"> <li>► Consult a qualified specialist workshop.</li> </ul>
The engine does not start. You cannot hear the starter motor.	<p>The on-board voltage is too low because the battery is too weak or discharged.</p> <ul style="list-style-type: none"> <li>► Jump-start the vehicle (► page 376).</li> </ul> <p>If the engine does not start despite attempts to jump-start it:</p> <ul style="list-style-type: none"> <li>► Consult a qualified specialist workshop.</li> </ul> <p>The starter motor was exposed to a thermal load that was too high.</p> <ul style="list-style-type: none"> <li>► Try to start the engine again.</li> </ul> <p>If the engine still does not start:</p> <ul style="list-style-type: none"> <li>► Consult a qualified specialist workshop.</li> </ul>
The engine is not running smoothly and is misfiring.	<p>There is a malfunction in the engine electronics or in a mechanical component of the engine management system.</p> <ul style="list-style-type: none"> <li>► Only depress the accelerator pedal slightly. Otherwise, non-combusted fuel may get into the catalytic converter and damage it.</li> <li>► Have the cause rectified immediately at a qualified specialist workshop.</li> </ul>
The coolant temperature gauge shows a value above 248 °F (120 °C).	<p>The coolant level is too low. The coolant is too hot and the engine is no longer being cooled sufficiently.</p> <ul style="list-style-type: none"> <li>► Stop as soon as possible and allow the engine and the coolant to cool down.</li> <li>► Check the coolant level (► page 356). Observe the warning notes as you do so and add coolant if necessary.</li> </ul>

## Automatic transmission

### Important safety notes

#### WARNING

If the engine speed is above the idling speed and you engage transmission position **D** or **R**, the vehicle could pull away suddenly. There is a risk of an accident.

When engaging transmission position **D** or **R**, always firmly depress the brake pedal and do not simultaneously accelerate.

#### WARNING

The automatic transmission switches to neutral position **N** when you switch off the engine. The vehicle may roll away. There is a risk of an accident.

After switching off the engine, always switch to parking position **P**. Prevent the parked vehicle from rolling away by applying the parking brake.

Observe the important safety notes for PLUG-IN HYBRID vehicles (▷ page 42).

## DIRECT SELECT lever

### Overview of transmission positions



- P** Park position with parking lock
- R** Reverse gear
- N** Neutral
- D** Drive

The DIRECT SELECT lever is on the right of the steering column.

The DIRECT SELECT lever always returns to its original position. The current transmission position **P**, **R**, **N** or **D** appears in the transmission position display (▷ page 172) in the multifunction display.

### Engaging park position P

- !** If the engine speed is too high or the vehicle is moving, do not shift the automatic transmission directly from **D** to **R**, from **R** to **D** or directly to **P**. The automatic transmission could otherwise be damaged.

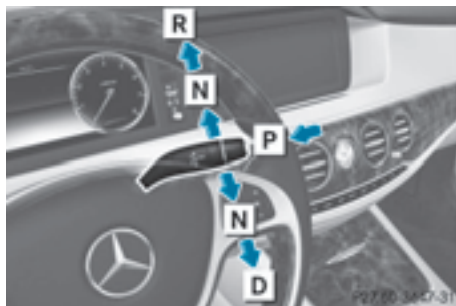

- P** Park position with parking lock
- R** Reverse gear
- N** Neutral
- D** Drive

- ▶ Push the DIRECT SELECT lever in the direction of arrow **P**.

### Engaging park position P automatically

Park position **P** is automatically engaged if:

- you switch off the engine using the SmartKey and remove the SmartKey
- you switch off the engine using the SmartKey or using the Start/Stop button and open the driver's door or front-passenger door
- the driver's door is opened when the vehicle is stationary or driving at very low speed and the transmission is in position **D** or **R**

Under certain conditions, the automatic transmission shifts automatically to transmission position **P** if the HOLD function or DISTRONIC PLUS is activated. Observe the information on the HOLD function (▷ page 209) and on DISTRONIC PLUS (▷ page 203).

## Engaging reverse gear R

**!** Only shift the automatic transmission to **R** when the vehicle is stationary.

- ▶ If the transmission is in position **D** or **N**: push the DIRECT SELECT lever up past the first point of resistance.
- ▶ If the transmission is in position **P**: depress the brake pedal and push the DIRECT SELECT lever up past the first point of resistance.

The ECO start/stop function is not available when reverse gear is engaged. Further information on the ECO start/stop function (▷ page 166).

## Shifting to neutral N

### WARNING

If children are left unsupervised in the vehicle, they could:

- open the doors, thus endangering other people or road users.
- get out and disrupt traffic.
- operate the vehicle's equipment.

Additionally, children could set the vehicle in motion if, for example, they:

- release the parking brake.
- shifting the automatic transmission out of park position **P**
- Start the engine.

There is a risk of an accident and injury.

When leaving the vehicle, always take the SmartKey with you and lock the vehicle. Never leave children or animals unattended in the vehicle. Always keep the SmartKey out of reach of children.

- ▶ If the transmission is in position **D** or **R**: push the DIRECT SELECT lever up or down to the first point of resistance.
- ▶ If the transmission is in position **P**: depress the brake pedal and push the DIRECT SELECT lever up or down to the first point of resistance.

If you switch the engine off with the transmission in position **R** or **D**, the automatic transmission shifts to **N** automatically.

**With the SmartKey:** if you then open the driver's door or the front-passenger door or remove the SmartKey from the ignition, the automatic transmission shifts to **P** automatically.

**With the Start/Stop button:** if you then open the driver's door or the front-passenger door, the automatic transmission shifts to **P** automatically.

If you want the automatic transmission to remain in neutral **N**, e.g. when having the vehicle cleaned in an automatic car wash with a towing system:

### Using the SmartKey:

- ▶ Switch on the ignition.
- ▶ Depress the brake pedal and keep it depressed.
- ▶ Shift to neutral **N**.
- ▶ Release the brake pedal.
- ▶ Release the electric parking brake.
- ▶ Switch off the ignition and leave the SmartKey in the ignition lock.

### With the Start/Stop button:

- ▶ Remove the Start/Stop button from the ignition lock.
- ▶ Insert the SmartKey into the ignition lock.
- ▶ Switch on the ignition.
- ▶ Depress the brake pedal and keep it depressed.
- ▶ Shift to neutral **N**.
- ▶ Release the brake pedal.
- ▶ Release the electric parking brake.
- ▶ Switch off the ignition and leave the SmartKey in the ignition lock.

## Engaging drive position D

- ▶ If the transmission is in position **R** or **N**: push the DIRECT SELECT lever down past the first point of resistance.
- ▶ If the transmission is in position **P**: depress the brake pedal and push the DIRECT SELECT lever down past the first point of resistance.

### Transmission position display

#### All vehicles (except Mercedes-AMG vehicles)

The current transmission position and drive program appear in the multifunction display.



- ① Transmission position
- ② Gear
- ③ Drive program

The arrows in the transmission position display show how and into which transmission positions you can shift using the DIRECT SELECT lever.

If the transmission position display in the multifunction display is not working, you should pull away carefully to check whether the desired transmission position is engaged. Ideally, you should select transmission position **D** and drive program **E** (for PLUG-IN HYBRID vehicles select drive program **E+**) or **S**.

#### Mercedes-AMG vehicles

The current transmission position and drive program appear in the multifunction display.



- ① Transmission position
- ② Drive program

The arrows in the transmission position display show how and into which transmission positions you can shift using the DIRECT SELECT lever.

If the transmission position display in the multifunction display is not working, you should pull away carefully to check whether the desired transmission position is engaged. Ideally, you should select transmission position **D** and drive program **C** or **S**.

### Transmission positions

#### **P** Park position

Only shift the transmission into position **P** when the vehicle is stationary (▷ page 189). The parking lock should not be used as a brake when parking. Always apply the electronic parking brake in addition to the parking lock in order to secure the vehicle.

If the vehicle electronics are malfunctioning, the transmission may be locked in position **P**. Have the vehicle electronics checked immediately at a qualified specialist workshop.

#### **R** Reverse gear

Only shift the transmission into position **R** when the vehicle is stationary.

#### **N** Neutral

Do not shift the transmission to **N** while driving. Otherwise, the automatic transmission could be damaged.

No power is transmitted from the engine to the drive wheels.

Releasing the brakes will allow you to move the vehicle freely, e.g. to push it or tow it.

If ESP® is deactivated or faulty: shift the transmission to position **N** if the vehicle is in danger of skidding, e.g. on icy roads.

**!** Rolling in neutral **N** can damage the drive train.

#### **D** Drive

The automatic transmission changes gear automatically. All forward gears are available.

## Driving tips

### Changing gear

The automatic transmission shifts to the individual gears automatically when it is in transmission position **D**. This automatic gear shifting behavior is determined by:

- the selected drive program (▷ page 173)
- the position of the accelerator pedal (▷ page 173)
- the road speed

### Accelerator pedal position

Your style of driving influences how the automatic transmission shifts gear:

- little throttle: early upshifts
- more throttle: late upshifts

### Kickdown

Use kickdown for maximum acceleration.

- ▶ Depress the accelerator pedal beyond the pressure point.  
The automatic transmission shifts to a lower gear depending on the engine speed.
- ▶ Ease off the accelerator pedal once the desired speed is reached.  
The automatic transmission shifts back up.

### Rocking the vehicle free

Rocking the vehicle free by shifting back and forth between transmission positions **D** and **R** can help to free a vehicle that has become stuck in mud or snow. The vehicle's engine management restricts switching between transmission positions **D** and **R** to speeds up to a maximum of 5 mph (9 km/h). To shift back and forth between transmission positions **D** and **R**, move the DIRECT SELECT lever up and down past the point of resistance.

### Program selector button

This section describes the program selector button for all vehicles except PLUG-IN HYBRID vehicles. Information on automatic drive programs for PLUG-IN HYBRID vehicles (▷ page 250).



- ▶ **All vehicles (except Mercedes-AMG vehicles and PLUG-IN HYBRID):** press program selector button ① to change the drive program.  
The selected drive program appears in the multifunction display.



- ▶ **Mercedes-AMG vehicles:** press program selector button ① repeatedly until the letter for the desired drive program appears in the multifunction display.

The program selector button influences:

- the drive program (▷ page 174)
- the engine management

On Mercedes-AMG vehicles, drive program **E** is called drive program **C**.

The automatic transmission switches to automatic drive program **E** (drive program **C** in Mercedes-AMG vehicles).

**All vehicles (except Mercedes-AMG vehicles and PLUG-IN HYBRID vehicles)**

<b>E</b> Economy	Comfortable, economical driving
<b>S</b> Sport	Sporty driving style

You can also activate manual drive program **M** using the steering wheel paddle shifters (▷ page 174). In manual drive program **M**, you can briefly change gear yourself by using the steering wheel paddle shifters.

#### Mercedes-AMG vehicles

<b>C</b> Controlled Efficiency	Comfortable, economical driving
<b>S</b> Sport	Sporty driving style
<b>M</b> Manual	Manual gear shifting

Permanent drive program **M** is only available for Mercedes-AMG vehicles.

Further information about permanent drive program **M** (▷ page 175).

You can also activate manual drive program **M** using the steering wheel paddle shifters (▷ page 174). In manual drive program **M**, you can briefly change gear yourself by using the steering wheel paddle shifters.

For further information on the automatic drive program, see (▷ page 174).

#### Steering wheel paddle shifters



You can activate manual drive program **M** in the **E** (**C** in AMG vehicles) and **S** automatic drive programs using steering wheel paddle shifters ① and ② (▷ page 174). In manual drive program **M**, you can briefly change gear yourself by using the steering wheel paddle shifters.

**Mercedes-AMG vehicles:** you can also activate manual drive program **M** with the program selector button (▷ page 175). In manual drive program **M**, you can permanently change gear yourself by using the steering wheel paddle shifters.

#### Automatic drive program

##### Automatic drive program E

Drive program **E** (drive program **C** on Mercedes-AMG vehicles) is characterized by the following:

- comfort-oriented engine settings.
- optimal fuel consumption resulting from the automatic transmission shifting up sooner.
- the vehicle pulling away more gently in forward and reverse gears, unless the accelerator pedal is depressed fully.
- the vehicle having improved driving stability, for example on slippery road surfaces.
- the automatic transmission shifting up sooner. This results in the vehicle being driven at lower engine speeds and the wheels being less likely to spin.

##### Automatic drive program S

Drive program **S** is characterized by the following:

- sporty engine settings.
- the vehicle pulling away in first gear.
- the automatic transmission shifting up later. The fuel consumption possibly being higher as a result of the later automatic transmission shift points.

##### Manual drive program M

#### General notes

In this drive program, you can briefly change gear yourself by using the steering wheel paddle shifters. The transmission must be in position **D**.

You can activate manual drive program **M** in the **E** (**C** in Mercedes-AMG vehicles) and **S** automatic drive programs.

**Mercedes-AMG vehicles:** as well as temporary drive program **M**, you can also activate permanent drive program **M**. Further information about permanent drive program **M** (▷ page 175).

#### Activating

- ▶ Shift the transmission to position **D**.
- ▶ Pull the left or right steering wheel paddle shifter (▷ page 174). Manual drive program **M** is temporarily activated.



**All vehicles (except Mercedes-AMG vehicles:)** **M** and the selected gear appear in the multifunction display.

Further information on activating manual drive program **M** on PLUG-IN HYBRID vehicles (▷ page 250).

### Shifting gears

If you pull on the left or right steering wheel paddle shifter, the automatic transmission switches to manual drive program **M** for a limited amount of time. Depending on which paddle shifter is pulled, the automatic transmission immediately shifts into the next gear down or up, if permitted.

- ▶ **To shift up:** pull the right-hand steering wheel paddle shifter (▷ page 174).

The automatic transmission shifts up to the next gear.

If the maximum engine speed on the currently engaged gear is reached and you continue to accelerate, the automatic transmission automatically shifts up in order to prevent engine damage.

**Mercedes-AMG vehicles:** the automatic transmission will not shift up to the next gear when the engine speed is very low.

- ▶ **To shift down:** pull on the left-hand steering wheel paddle shifter (▷ page 174). The automatic transmission shifts down to the next gear.

If the engine exceeds the maximum engine speed when shifting down, the automatic transmission protects against engine damage by not shifting down.

Automatic down shifting occurs when coasting.

### Shift recommendation



The gearshift recommendations assist you in adopting an economical driving style. The recommended gear is shown in the multifunction display.

- ▶ Shift to recommended gear ② according to gearshift recommendation ① when shown in the multifunction display of the instrument cluster.

### Deactivating

If you have activated manual drive program **M**, it will remain active for a certain amount of time. Under certain conditions the minimum amount of time is extended, e.g. in the case of lateral acceleration, during an overrun phase or when driving on steep terrain.

If manual drive program **M** has been deactivated, the automatic transmission shifts into the automatic drive program that was last selected.

You can also deactivate manual drive program **M** yourself:

- ▶ Pull on the right-hand steering wheel paddle shifter and hold it in place (▷ page 174).

or

- ▶ Use the DIRECT SELECT lever to switch the transmission position.

or

- ▶ Use the program selector button to change the drive program (▷ page 173). Manual drive program **M** is deactivated. The automatic transmission switches to the previously activated drive program **E** (drive program **C** on Mercedes-AMG vehicles) or **S**.

### Manual drive program (Mercedes-AMG vehicles)

#### General information

In this drive program, you can permanently change gear yourself by using the steering wheel paddle shifters. The transmission must be in position **D**.

Manual drive program **M** is different from drive program **S** with regard to spontaneity, responsiveness and smoothness of gear changes.

As well as this permanent drive program **M**, you can also activate temporary drive program **M** (▷ page 174).

## Switching on the manual drive program

In manual drive program **M**, you can change gear using the steering wheel paddle shifters if the transmission is in position **D**. You can see the currently selected drive program and which gear is engaged in the multifunction display.

- ▶ Press the program selector button (▷ page 173) repeatedly until **M** appears in the multifunction display.

## Upshifting

**!** In manual drive program **M**, the automatic transmission does not shift up automatically even when the engine limiting speed for the current gear is reached. When the engine limiting speed is reached, the fuel supply is cut to prevent the engine from overrevving. Always make sure that the engine speed does not reach the red area of the tachometer. There is otherwise a risk of engine damage.



- ① Gear indicator
- ② Upshift indicator

Before the engine speed reaches the red area, an upshift indicator will be shown in the multifunction display.

- ▶ When message ② appears in the multifunction display, pull on the right-hand steering wheel paddle shifter.

## Downshifting

- ▶ Pull the left-hand steering wheel paddle shifter (▷ page 174). The automatic transmission shifts down to the next gear if this is permissible.

Maximum acceleration

- ▶ Pull the left-hand steering wheel paddle shifter until the transmission selects the optimum gear according to the speed.

If you slow down or stop without shifting down, the automatic transmission automatically shifts down.

## Switching off the manual drive program

- ▶ Press the program selector button (▷ page 173) repeatedly until **C** or **S** appears in the multifunction display.

## Problems with the transmission

Problem	Possible causes/consequences and ► Solutions
The transmission has problems shifting gear.	The transmission is losing oil. ► Have the transmission checked at a qualified specialist workshop immediately.
The acceleration ability is deteriorating. The transmission no longer changes gear.	The transmission is in emergency mode. <b>7G-TRONIC:</b> it is only possible to shift into <b>second</b> gear and reverse gear. <b>9G-TRONIC:</b> it is only partly possible to engage the gears or the transmission is in position <b>N</b> . ► Stop the vehicle. ► Shift the transmission to position <b>P</b> . ► Switch off the engine. ► Wait at least ten seconds before restarting the engine. ► Shift the transmission to position <b>D</b> or <b>R</b> . <b>7G-TRONIC:</b> If <b>D</b> is selected, the transmission shifts into <b>second</b> gear, if <b>R</b> is selected, the transmission shifts into reverse gear. ► Have the transmission checked at a qualified specialist workshop immediately.

Problems with PLUG-IN HYBRID operation (> page 254).

### Transfer case

This section is only valid for vehicles with 4-wheel drive (4MATIC). Power is always transmitted to both axles.

❗ Performance tests may only be carried out on a 2-axle dynamometer. The brake system or transfer case could otherwise be damaged. Contact a qualified specialist workshop for a performance test.

❗ Since ESP® engages automatically, the ignition must be switched off (the SmartKey or Start/Stop button must be in position **0** or **1**) if:

- the electric parking brake is being tested on a brake dynamometer
- the vehicle is being towed with only one axle raised (not permitted for vehicles with 4MATIC).

The brake system could otherwise be damaged.

❗ Vehicles with 4MATIC must not be towed with either the front or the rear axle raised, as doing so will damage the transmission.

## Refueling

### Important safety notes

#### WARNING

Fuel is highly flammable. If you handle fuel incorrectly, there is a risk of fire and explosion.

You must avoid fire, open flames, creating sparks and smoking. Switch off the engine and, if applicable, the auxiliary heating before refueling.

#### WARNING

Fuel is poisonous and hazardous to health. There is a risk of injury.

You must make sure that fuel does not come into contact with your skin, eyes or clothing

and that it is not swallowed. Do not inhale fuel vapors. Keep fuel away from children.

If you or others come into contact with fuel, observe the following:

- Wash away fuel from skin immediately using soap and water.
- If fuel comes into contact with your eyes, immediately rinse them thoroughly with clean water. Seek medical assistance without delay.
- If fuel is swallowed, seek medical assistance without delay. Do not induce vomiting.
- Immediately change out of clothing which has come into contact with fuel.

### WARNING

Electrostatic buildup can create sparks and ignite fuel vapors. There is a risk of fire and explosion.

Always touch the vehicle body before opening the fuel filler flap or touching the fuel pump nozzle. Any existing electrostatic buildup is thereby discharged.

Do not get into the vehicle again during the refueling process. Otherwise, electrostatic charge could build up again.

**!** Do not use diesel to refuel vehicles with a gasoline engine. Do not switch on the ignition if you accidentally refuel with the wrong fuel. Otherwise, the fuel will enter the fuel system. Even small amounts of the wrong fuel could result in damage to the fuel system and the engine. Notify a qualified specialist workshop and have the fuel tank and fuel lines drained completely.

**!** Overfilling the fuel tank could damage the fuel system.

**!** Take care not to spill any fuel on painted surfaces. You could otherwise damage the paintwork.

**!** Use a filter when refueling from a fuel can. Otherwise, the fuel lines and/or injection system could be blocked by particles from the fuel can.

If you overfill the fuel tank, fuel could spray out when the fuel pump nozzle is removed.

For further information on fuel and fuel quality (> page 428).

## Refueling

### General information

Pay attention to the important safety notes (> page 177).

**PLUG-IN HYBRID vehicles:** pressure in the fuel tank must be released before refueling.

**Except PLUG-IN HYBRID vehicles:** if you unlock/lock the vehicle from the outside, the fuel filler flap also unlocks/locks.

The position of the fuel filler cap is displayed in the instrument cluster . The arrow next to the filling pump indicates the side of the vehicle.

### Preparing to refuel

- ▶ Switch off the engine.
- ▶ Open the driver's door.
  - The on-board electronics now have status **0**. This is the same as the SmartKey having been removed.

or, if the SmartKey is inserted in the ignition lock:

- ▶ Remove the SmartKey from the ignition lock.

### Opening the fuel filler flap (except PLUG-IN HYBRID vehicles)

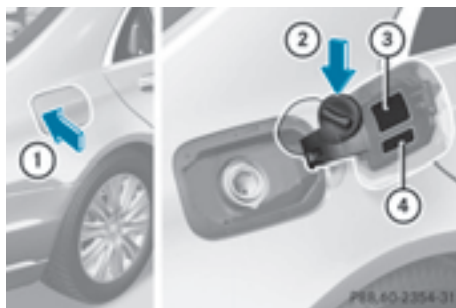

- ① To open the fuel filler flap
- ② To insert the fuel filler cap
- ③ Tire pressure table
- ④ Fuel type to be used

- ▶ Press the fuel filler flap in the direction of arrow ①.  
The fuel filler flap swings up.
- ▶ Turn the fuel filler cap counterclockwise and remove it.
- ▶ Insert the fuel filler cap into the holder on the inside of the fuel filler flap.
- ▶ Completely insert the filler neck of the fuel pump nozzle into the tank, hook in place and refuel.
- ▶ Only fill the tank until the pump nozzle switches off.  
Do not add any more fuel after the pump stops filling for the first time. Otherwise, fuel may leak out.

### Opening the fuel filler flap (PLUG-IN HYBRID vehicles)



- ▶ Pull switch ①.  
Indicator lamp ② flashes and the **Please Wait Depressurizing Tank** message appears in the multifunction display.  
If the fuel filler cap is open, indicator lamp ② lights up.  
The **Tank is Depressurized Ready for Refueling** message appears in the multifunction display.  
Please be sure to observe the information on refueling on the fuel filler flap.
- There is a malfunction if:
- indicator lamp ② first flashes and then goes out
  - the yellow engine diagnostics warning lamp lights up
- ❗ From a speed of 2 km/h, the fuel filler cap can no longer be opened.

- ❗ The opening process for the fuel filler cap may take up to 15 minutes.

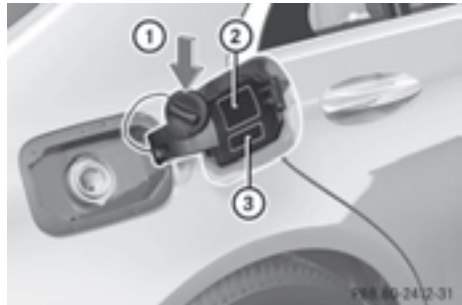

- ① To insert the fuel filler cap
  - ② Tire pressure table
  - ③ Fuel type to be used
- ▶ Turn the fuel filler cap counterclockwise and remove it.
  - ▶ Insert the fuel filler cap into the holder on the inside of the fuel filler flap.
  - ▶ Completely insert the filler neck of the fuel pump nozzle into the tank, hook in place and refuel.
  - ▶ Only fill the tank until the pump nozzle switches off.  
Do not add any more fuel after the pump stops filling for the first time. Otherwise, fuel may leak out.

### Closing the fuel filler flap

- ▶ Replace the cap on the filler neck and turn clockwise until it engages audibly.
- ▶ Close the fuel filler flap.

Close the fuel filler flap before locking the vehicle.

If you drive at speeds above 1 mph (2 km/h) with the fuel filler flap open, the **Fuel Filler Flap Open** message is shown in the multifunction display.

If you are driving with the fuel filler cap open, the  reserve fuel warning lamp flashes. A message appears in the multifunction display (▷ page 296).

In addition, the  Check Engine warning lamp may light up (▷ page 320).

- ❗ For further information on warning and indicator lamps in the instrument cluster, see (▷ page 320).

## Problems with fuel and the fuel tank

Problem	Possible causes/consequences and ► Solutions
Fuel is leaking from the vehicle.	<p> <b>WARNING</b></p> <p>The fuel line or the fuel tank is faulty. Risk of explosion or fire.</p> <ul style="list-style-type: none"> <li>► Apply the electric parking brake.</li> <li>► Switch off the engine.</li> <li>► Make sure that the ignition is switched off (► page 162).</li> </ul> <p>or</p> <ul style="list-style-type: none"> <li>► When using the SmartKey, turn the SmartKey to position <b>0</b> in the ignition lock and remove it (► page 162).</li> <li>► Do not restart the engine under any circumstances.</li> <li>► Consult a qualified specialist workshop.</li> </ul>
The fuel filler flap cannot be opened.	<p>The fuel filler flap is not unlocked.</p> <ul style="list-style-type: none"> <li>► Unlock the vehicle (► page 79).</li> <li>► <b>PLUG-IN HYBRID Vehicles:</b> depressurize the fuel tank (► page 178).</li> </ul>
	<p>The SmartKey battery is discharged or nearly discharged.</p> <ul style="list-style-type: none"> <li>► Unlock the vehicle using the mechanical key (► page 81).</li> </ul>
	<p>The fuel filler flap is unlocked, but the opening mechanism is jammed.</p> <ul style="list-style-type: none"> <li>► Consult a qualified specialist workshop.</li> </ul>

## Charging the high-voltage battery (PLUG-IN HYBRID vehicles)

## Important safety notes

 **DANGER**

The vehicle's high-voltage electrical system is under high voltage. If you modify components in the vehicle's high-voltage electrical system or touch damaged components, you may be electrocuted. The components in the vehicle's high-voltage electrical system may be damaged in an accident, although the damage is not visible. There is a risk of fatal injury.

Following an accident, do not touch any high-voltage components and never modify the vehicle's high-voltage electrical system. Have the vehicle towed away after an accident and the vehicle's high-voltage electrical system checked by a qualified specialist workshop.

 **WARNING**

In the event of a vehicle fire, the internal pressure of the high-voltage battery can exceed a critical value. In this case flammable gas escapes through a ventilation valve on the underbody. The gas can ignite. There is a risk of injury.

Leave the danger zone immediately. Secure the danger area at a suitable distance, whilst observing legal requirements.

 **DANGER**

If you use incorrectly installed mains sockets or adapters, extension cables or similar to connect the charging cable to a mains socket, this could lead to fires or an electric shock. There is a risk of fatal injury.

To avoid hazardous situations, observe the following:

- Only connect the charging cable to mains sockets that:
  - are installed correctly and
  - have been approved by an electrical specialist.
- For safety reasons, only use the charging cables supplied with the vehicle, or charging cables which have been approved for use with this vehicle.
- Never use a damaged charging cable.
- Do **not** use:
  - Extension cables
  - Cable drums
  - Multiple sockets
- Do not use a socket adapter to connect the charging cable to the mains socket. The only exception is if the adapter has been tested and approved by the manufacturer for charging the high-voltage battery in an electric vehicle.
- Always observe the safety notes in the socket adapter's operating instructions.

### **DANGER**

Connecting the charging cable to the vehicle via an incorrectly installed wallbox or by means of adapters, extension cables or similar could cause a fire or an electric shock. There is a risk of fatal injury.

To avoid hazardous situations, observe the following:

- Only connect the charging cable to a wallbox if:
  - the wallbox is installed correctly
  - the wallbox has been inspected by a qualified electrician and
  - the charging cable is undamaged
- Do not extend the charging cable
- Do not use an adapter
- Always observe the safety notes in the wallbox's operating instructions

The vehicle's high voltage electrical system is under high voltage.

- Do not tamper with the high-voltage components or the orange cables of the high-voltage electrical system.
- Do not touch high-voltage components or the orange cables of the high-voltage electrical system when a vehicle has been involved in a crash.
- Never touch damaged components or the damaged orange cables of the high-voltage electrical system.
- Do not remove the covers of the high-voltage electrical system components that are marked with a warning sticker.

### General notes

#### Method of operation

The vehicle is equipped with a high-voltage battery for driving. The high-voltage battery stores the energy needed to operate the electric motor and releases it again.

The electric motor uses energy that has been stored in the high-voltage battery when pulling away, accelerating and during the journey.

In overrun mode, kinetic energy is converted by means of energy recuperation into electrical energy and stored in the high-voltage battery. Information on overrun mode (> page 253).

The high-voltage battery can be charged as follows:

- through energy recuperation while the vehicle is in motion
- through the combustion engine while driving in CHARGE operating mode (> page 243)
- with the relevant charging cable at an electrical outlet while the vehicle is stationary
- at a wallbox while the vehicle is stationary
- at a charging station while the vehicle is stationary

The high-voltage battery can be charged in a nominal voltage range from 100 V to 240 V.

You can view the condition of charge of the high-voltage battery in the multifunction display. You can find information in "PLUG-IN HYBRID operation", section "Menus and submenus" under "Energy flow display" (> page 245).

## High and low outside temperatures

### Low outside temperatures

At very low outside temperatures the maximum power output of the high-voltage battery may be reduced. The high-voltage battery is then no longer able to provide the normal electrical power output.

### High outside temperatures

To prevent damage to the high-voltage battery due to very high outside temperatures, the maximum power output of the high-voltage battery is reduced by the vehicle.

## Energy consumption and electrical range

The maximum electrical range is generally reduced by:

- high and low outside temperatures
- operating the climate control system
- switching on consumers

The battery's physical characteristics are such that leaving the vehicle parked for long periods at low outdoor temperatures without charging it can lead to:

- a reduction in battery performance
- longer charge times

## Notes on battery care

Avoid storing or transporting the vehicle at excessively high or low temperatures over a long period.

If you park the vehicle and leave it stationary for long periods:

- check the condition of charge of the high-voltage battery more often
- connect the vehicle to a power supply

This prevents self-discharge and damage to the high-voltage battery.

## Terms of use

Please note the information on exceptions and limitations in warranty documentation and in the Maintenance Booklet.

## Handling the charging cable and charging cable controls

Do not leave the charging cable controls (> page 183) hanging loose from an electrical outlet. Otherwise, this could result in a poor contact with the electrical outlet and malfunctions when charging the vehicle.

To ensure that the brackets within the charging cable controls are not subjected to incorrect loads, observe the following:

- Never lift or carry the controls by the charging cable connector or the mains plug.
- To transport the charging cable, the charging cable can be:
  - wrapped around the controls or
  - secured to the housing of the controls

## Heat generated by the charging cable and charging cable connector

Pay attention to the "Important safety notes" (> page 180).

During the charging process, the charging cable and charging cable connector may heat up.

The charging cable and the charging cable connector will only heat up within the permissible limiting values, provided that:

- the power supply and the charging cable are not damaged
- the instructions for handling the charging cable and controls on the charging cable are observed

If the charging cable or charging cable connector become too hot, have the mains power supply checked.

## Protection device against overvoltage

**!** Overvoltage in the mains supply may damage the vehicle. For this reason, the vehicle is equipped with a protection device against overvoltage in the mains supply. This device may be triggered during severe thunderstorms, for example, and may lead to the building's fuse being tripped and an interruption in the power supply. These functions protect the vehicle. After the building fuse is switched on again, the charging process resumes automatically. Following an interruption in the power supply or tripping of the building's fuse, it may take up to 10 minutes for charging to resume automatically.



Switch on the building protection system again after it has been triggered. Otherwise, the charging process cannot be continued.

### General information about the charging procedure

Pay attention to the "Important safety notes" (▷ page 180).

The vehicle socket is located in the rear bumper on the right below the tail lamp.

The charge socket flap and the vehicle are centrally locked or unlocked simultaneously.

### Charging the high-voltage battery via the electrical outlet

#### Charging cable for electrical outlets

#### Important safety notes

**I** Only use the charging cable to charge the high-voltage battery. Do not use the charging cable for other purposes. It may otherwise be damaged.

The vehicle is supplied with a country-specific charging cable for connection to a mains socket. Only use the charging cable supplied with the vehicle or a charging cable approved for the vehicle.

**i** If you use the supplied 12 A charging cable to charge a high-voltage battery:

- the charge time increases considerably
- electrical consumption increases considerably

Where possible, charge the high-voltage battery at a charging station (▷ page 186). Only then can certified electrical energy consumption levels be reached.

**i** The charging process can vary depending on the power supply. Therefore, always observe the local information.

Information about charging from a wallbox can be found at (▷ page 185).

Information about charging at a charging station can be found at (▷ page 186).

### Stowing the charging cable

The charging cable can be stowed and held in place in the bag provided in the trunk of the vehicle.

### Controls on the charging cable

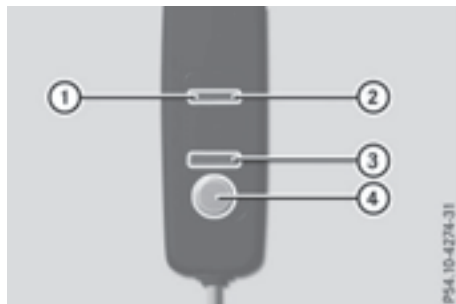

- ① On-board voltage indicator
- ② Protective and indicator system display
- ③ Charge current indicator
- ④ Charge current setting button

When displays ① and ② on the charging cable light up, this means the following:

Display ①	
Lights up green	The on-board voltage is connected. The high-voltage battery can be charged.
Flashes red	The power supply from the building is faulty.

Display ②	
Lights up green	There are no malfunctions. The high-voltage battery can be charged.
Flashes red	The protective and indicator system has detected a malfunction due to an internal malfunction. The high-voltage battery cannot be charged.

If the control detects residual current or a malfunction, the charging process is halted. Once the malfunction has been rectified the charging process is resumed automatically.

For information on problems relating to the charging process, see (▷ page 187).

## Setting the maximum charge current

### WARNING

If the charge current draw via a mains socket is too high during the charging process, the external electrical system may overheat.

There is a risk of fire.

Before beginning the charging process, check the maximum permissible charge current locally. Consult a qualified expert to do so where necessary.

If necessary, adjust your vehicle's settings.

- !** An excessive charge current can blow a fuse or lead to overheating of the external power supply. Check whether the external power supply is compatible with the set charge current. If necessary, lower the set charge current or use another power socket.

Before starting the charging process at a power socket, check the maximum permissible charge current for the relevant power socket or the building.

You can set the maximum permissible charge current:



- on the controls of the charging cable
- in the on-board computer menu (> page 272).

The lower value of the two charge current settings – on the charge cable controls and in the on-board computer – determines the maximum charge current. If you cannot set the precise maximum permitted charge current, select the next lowest available value.

Only set the maximum permitted charge current in the on-board computer menu if:

- it is not possible to set the charge current on the charging cable
- the precise maximum permitted charge current can only be set via the on-board computer

How to set the maximum permissible charge current on the charging cable, is described as follows.

- **To adjust the setting:** press button  repeatedly until the desired setting is selected in display .
- Two LEDs are flashing: minimum setting
  - All LEDs are flashing: maximum setting

If, after the charging process, the charging cable is:

- left connected to the power socket, the currently selected values will be used for the next charging process.
- removed from the power socket, the values will be reset to the minimum setting for the next charging process. You may then need to reset the values of the maximum charge current.

- i** If the vehicle requires more time than usual when charging, check the maximum charge current settings using the controls on the charging cable or in the on-board computer's menu.

## Indicator lamp on the vehicle socket

When the indicator lamp on the vehicle socket lights up, this means the following:

Indicator lamp	
Flashes orange	The connection between the vehicle and the current source is being established before charging begins.
Flashes green	The high-voltage battery is being charged.
Flashes red	A malfunction has occurred while charging. The indicator lamp goes out after approximately 90 seconds.
Lights up orange	A charging break for the high-voltage battery is taking place. The indicator lamp goes out after approximately 90 seconds.
Lights up green	The high-voltage battery is fully charged. The indicator lamp goes out after approximately 90 seconds.

- i** If the indicator lamp is off, lock or unlock the vehicle. The indicator lamp then displays the current status of the charging process again.

## Connecting the charging cable

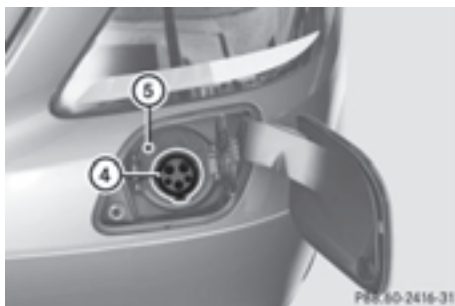
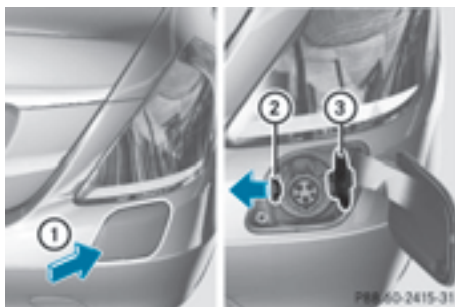

- ▶ Shift the transmission to position **P**.
- ▶ Switch the ignition off.
- ▶ Press the charge socket flap in the direction of arrow ①.  
The charge socket flap swings up.
- ▶ Press fastener ② to the left.  
Socket cap ③ is open.
- ▶ Insert the power supply plug into the electrical outlet to the stop.
- ▶ Insert the charging cable connector into vehicle socket ④ to the stop.  
Indicator lamp ⑤ first flashes orange and then green.  
The high-voltage battery is being charged.

If the charging cable is connected to the vehicle, you cannot start the engine or move the vehicle. When the charging process begins, you can view the charging prediction in the **Settings** menu of the on-board computer. The charging prediction is either the anticipated condition of charge at the programmed departure time or the time when the high-voltage battery will be fully charged (▷ page 272).

- ❗ Depending on the temperature, the fan and battery cooling system may audibly switch on during the charging process.

## Removing the charging cable

The high-voltage battery is fully charged when:

- the charge level display reaches 100% in the multifunction display (▷ page 245)
- the indicator lamp in the vehicle socket lights up green after unlocking or locking the vehicle



- ▶ Press and hold button ⑥ on the charging cable connector and remove the charging cable connector from the vehicle socket.
- ▶ Close socket cap ③.
- ▶ Close charge socket flap ①.
- ▶ Remove the mains plug from the mains socket and safely stow away the charging cable inside the vehicle (▷ page 183).

## Charging the high-voltage battery from the wallbox

### General notes

It is recommended that you charge your vehicle using a wallbox or at a charging station.

Make sure that the maximum charging current is not limited in the **Settings** menu of the on-board computer. You must select the maximum value if charging at a wallbox or a charging station (▷ page 272).

Pay attention to the "Important safety notes" (▷ page 180).

## Connecting the charging cable

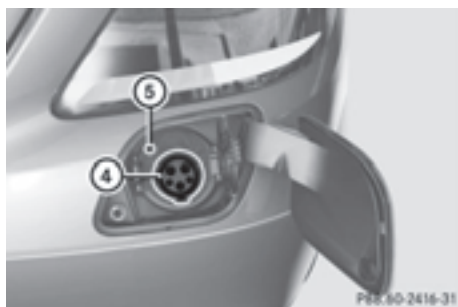
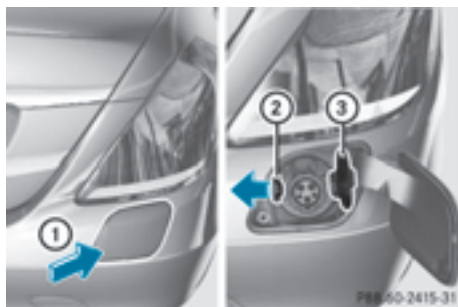

- ▶ Shift the transmission to position **P**.
- ▶ Switch the ignition off.
- ▶ Press the charge socket flap in direction of arrow ①.  
The charge socket flap swings up.
- ▶ Press fastener ② to the left.  
Socket cap ③ is open.
- ▶ Insert the charging cable connector into vehicle socket ④ to the stop.  
Indicator lamp ⑤ first flashes orange and then green.  
The high-voltage battery is being charged.

If the charging cable is connected to the vehicle, you cannot start the engine or move the vehicle. When the charging process begins, you can view the charging prediction in the **Settings** menu of the on-board computer. The charging prediction is either the anticipated condition of charge at the programmed departure time or the time when the high-voltage battery will be fully charged (▷ page 272).

- ▶ Depending on the temperature, the fan and battery cooling system may audibly switch on during the charging process.

## Removing the charging cable

The high-voltage battery is fully charged when:

- the charge level display reaches 100% in the multifunction display (▷ page 245)
- the indicator lamp in the vehicle socket lights up green after unlocking or locking the vehicle



- ▶ Press and hold button ⑥ on the charging cable connector and remove the charging cable connector from the vehicle socket.
- ▶ Close socket cap ③.
- ▶ Close charge socket flap ①.

## Charging the high-voltage battery at the charging station

Before beginning the charging process at a charging station without communication capabilities, you must first activate the station, e.g. using an RFID card. Observe the on-site operator instructions for the charging station.

The connection for the vehicle at a charging station is identical to the connection on a wallbox (▷ page 185).

Problems with the charging process	
Problem	Possible causes/consequences and ► Solutions
The charge socket flap cannot be opened.	<p>The charge socket flap is not unlocked.</p> <ul style="list-style-type: none"> <li>► Unlock the vehicle (▷ page 79).</li> </ul> <p>If the key battery is discharged:</p> <ul style="list-style-type: none"> <li>► Unlock the driver's door using the mechanical key (▷ page 81).</li> <li>or</li> <li>► Unlock the vehicle centrally from the inside (▷ page 86).</li> </ul> <p>The charge socket flap is unlocked, but the opening mechanism is jammed.</p> <ul style="list-style-type: none"> <li>► Lock the vehicle and unlock it again.</li> </ul> <p>If, after that, the opening mechanism is still jammed:</p> <ul style="list-style-type: none"> <li>► Consult a qualified specialist workshop.</li> </ul>
The high-voltage battery is not being charged.	<p>The indicator lamp on the vehicle socket flashes red. A malfunction has occurred during the initialization of the charging process or during charging.</p> <ul style="list-style-type: none"> <li>► Disconnect the charging cable connector from the vehicle socket and plug it back into the vehicle socket.</li> </ul> <p>If the problem persists:</p> <ul style="list-style-type: none"> <li>► Have the mains socket checked for correct function or use another mains socket.</li> <li>or</li> <li>► Use a different charging station.</li> <li>or</li> <li>► Consult a qualified specialist workshop.</li> </ul>

Problem	Possible causes/consequences and ► Solutions
	<p>The indicator lamp on the vehicle socket does not light up. No connection can be established between the vehicle and the external power source.</p> <ul style="list-style-type: none"> <li>► Connect the charging cable once again.</li> </ul> <p>If the problem persists:</p> <ul style="list-style-type: none"> <li>► Have the mains socket checked for correct function or use another mains socket.</li> </ul> <p>or</p> <ul style="list-style-type: none"> <li>► Use a different charging station.</li> </ul> <p>or</p> <ul style="list-style-type: none"> <li>► Consult a qualified specialist workshop.</li> </ul>
<p>The charging cable connector cannot be removed from the vehicle socket.</p>	<p>The snap fastener on the charging cable connector is locked.</p> <ul style="list-style-type: none"> <li>► Press and hold the button on the charging cable connector. The snap fastener on the vehicle socket is unlocked.</li> <li>► Remove the charging cable connector from the vehicle socket.</li> </ul> <p>If the snap fastener on the charging cable connector is locked:</p> <ul style="list-style-type: none"> <li>► Press and hold the button on the charging cable connector and try to release the lock.</li> </ul>

## Online access to the vehicle

### General information

#### WARNING

If you operate information systems and communication equipment integrated in the vehicle while driving, you will be distracted from traffic conditions. You could also lose control of the vehicle. There is a risk of an accident.

Only operate the equipment when the traffic situation permits. If you are not sure that this is possible, park the vehicle paying attention to traffic conditions and operate the equipment when the vehicle is stationary.

- i** **Operation of integrated information systems and communications equipment in the vehicle:** you must observe the legal requirements for the country in which you are currently driving.

Via the "My Mercedes Electric - Vehicle Homepage", you can call up remote query and remote configuration functions for your vehicle. This is

possible from an Internet-enabled computer, as well as many modern smartphones.

Please call the Mercedes-Benz Customer Assistance Center (USA) at the hotline number **1-800-FOR-MERCEDES (1-800-367-6372)** to obtain the relevant Internet address.

Access to "My Mercedes Electric - Vehicle Homepage" is dependent on the contractual periods of mbrace. Activated access to the mbrace emergency call system is required for use.

In order to use the "My Mercedes Electric - Vehicle Homepage", you must agree to the local terms of use.

Further information on supported devices, available languages and contractual periods can be obtained from any authorized Mercedes-Benz Center.

In order to call up the "Mercedes Electric - Vehicle Homepage", the vehicle must be connected to the Internet (▷ page 189).

### Notes on data protection

Bear in mind that the "My Mercedes Electric - Vehicle Homepage" offers access to your data.

**i Prevent unauthorized persons from accessing this data.**

Every person who has access to the information stated can use the functions on the "My Mercedes Electric - Vehicle Homepage".

**i Information when selling a vehicle or buying a used vehicle:**

- If you sell your vehicle, you are obliged to delete the vehicle from your personal area on the "My Mercedes Electric - Vehicle Homepage".
- If you have bought a used vehicle, it is possible that the previous owner still has access to the "My Mercedes Electric - Vehicle Homepage".

**Calling up functions**

The "My Mercedes Electric - Vehicle Homepage" allows you access to information about your vehicle and its functions using remote query and remote configuration.

The following functions can be accessed:

- request the current condition of charge of the high-voltage battery
- program the departure time (▷ page 272)
- set or activate the "Pre-entry climate control at departure time" function (see the separate COMAND operating instructions)

Information on additional functions and operating instructions can be found on the "My Mercedes Electric - Vehicle Homepage".

**Connecting the vehicle to the Internet**

**i** This function is not available in all countries and requires activated access to the mbrace emergency call system.

The "My Mercedes Electric - Vehicle Homepage" can be used if the vehicle has a connection to the Internet via a mobile phone network. The necessary data is transmitted by radio. The vehicle automatically recognizes whether a connection to the Internet is possible or not. No presets are necessary.

**i** Restrictions in reception are possible if the vehicle is in an underground car park, for example. Restrictions may also occur in areas with poor mobile network coverage.

**Parking**

**Important safety notes**

**⚠ WARNING**

Flammable material such as leaves, grass or twigs may ignite if they come into contact with hot parts of the exhaust system or exhaust gas flow. There is a risk of fire.

Park the vehicle so that no flammable materials come into contact with parts of the vehicle which are hot. Take particular care not to park on dry grassland or harvested grain fields.

**⚠ WARNING**

If you leave children unsupervised in the vehicle, they could set it in motion by, for example:

- release the parking brake.
- shift the automatic transmission out of the parking position **P**.
- start the engine.

In addition, they may operate vehicle equipment and become trapped. There is a risk of an accident and injury.

When leaving the vehicle, always take the SmartKey with you and lock the vehicle. Never leave children unsupervised in the vehicle.

**!** Always secure the vehicle correctly against rolling away. Otherwise, the vehicle or its drivetrain could be damaged.

To ensure that the vehicle is secured against rolling away unintentionally:

- the electric parking brake must be applied.
- the transmission must be in position **P** and the SmartKey must be removed from the ignition lock.
- the front wheels must be turned towards the curb on steep uphill or downhill gradients.
- the empty vehicle must be secured at the front axle with a wheel chock or similar, for example, on uphill or downhill gradients.
- a laden vehicle must also be secured at the rear axle with a wheel chock or similar, for example, on uphill or downhill gradients.

## Switching off the engine

### Important safety notes

#### WARNING

The automatic transmission switches to neutral position **N** when you switch off the engine. The vehicle may roll away. There is a risk of an accident.

After switching off the engine, always switch to parking position **P**. Prevent the parked vehicle from rolling away by applying the parking brake.

### Using the SmartKey

- ▶ Apply the electric parking brake.
- ▶ Shift the transmission to position **P**.
- ▶ Turn the SmartKey to position **0** in the ignition lock and remove it. The immobilizer is activated. If you switch the engine off with the transmission in position **R** or **D**, the automatic transmission shifts to **N** automatically. If you then open the driver's door or the front-passenger door or remove the SmartKey from the ignition, the automatic transmission shifts to **P** automatically.

If you want the automatic transmission to remain in neutral **N**, e.g. when having the vehicle cleaned in an automatic car wash with a towing system:

- ▶ Switch on the ignition.
- ▶ Depress the brake pedal and keep it depressed.
- ▶ Shift to neutral **N**.
- ▶ Release the brake pedal.
- ▶ Release the electric parking brake.
- ▶ Switch off the ignition and leave the SmartKey in the ignition lock.

### Using the Start/Stop button

- ▶ Apply the electric parking brake.
- ▶ Shift the transmission to position **P**.
- ▶ Press the Start/Stop button (▷ page 162) The engine stops and all the indicator lamps in the instrument cluster go out.

When the driver's door is closed, this corresponds to SmartKey position **1**. When the driver's door is open, this corresponds to SmartKey position **0**: "SmartKey removed".

If you switch the engine off with the transmission in position **R** or **D**, the automatic transmission shifts to **N** automatically.

If you then open the driver's or front-passenger door, the automatic transmission shifts to **P** automatically.

If you want the automatic transmission to remain in neutral **N**, e.g. when having the vehicle cleaned in an automatic car wash with a towing system:

- ▶ Switch on the ignition.
- ▶ Depress the brake pedal and keep it depressed.
- ▶ Remove the Start/Stop button from the ignition lock.
- ▶ Insert the SmartKey into the ignition lock.
- ▶ Shift to neutral **N**.
- ▶ Release the brake pedal.
- ▶ Release the electric parking brake.
- ▶ Switch off the ignition and leave the SmartKey in the ignition lock.

The engine can be switched off in an emergency while the vehicle is in motion by pressing and holding the Start/Stop button for three seconds. This function operates independently of the ECO start/stop automatic engine switch-off function.

## Electric parking brake

### General notes

#### WARNING

If you leave children unsupervised in the vehicle, they could set it in motion by, for example:

- release the parking brake.
- shift the automatic transmission out of the parking position **P**.
- start the engine.

In addition, they may operate vehicle equipment and become trapped. There is a risk of an accident and injury.



When leaving the vehicle, always take the SmartKey with you and lock the vehicle. Never leave children unsupervised in the vehicle.

The function of the electric parking brake is dependent on the on-board voltage. If the on-board voltage is low or there is a malfunction in the system, it may not be possible to apply the released parking brake.

- ▶ If this is the case, only park the vehicle on level ground and secure it to prevent it rolling away.
- ▶ Shift the automatic transmission to position **P**.

It may not be possible to release an applied parking brake if the on-board voltage is low or there is a malfunction in the system. Contact a qualified specialist workshop.

The electric parking brake performs a function test at regular intervals while the engine is switched off. The sounds that can be heard while this is occurring are normal.

### Applying or releasing manually



- ▶ **To engage:** push handle ①.  
When the electric parking brake is applied, the red **PARK** (USA only) or **(P)** (Canada only) indicator lamp lights up in the instrument cluster.

The electric parking brake can also be applied when the SmartKey is removed.

- ▶ **To release:** pull handle ①.  
The red **PARK** (USA only) or **(P)** (Canada only) indicator lamp in the instrument cluster goes out.

The electric parking brake can only be released:

- when the SmartKey is in position **1** or **2** in the ignition lock (▷ page 162) or
- if the ignition was switched on using the Start/Stop button

### Applying automatically

The electric parking brake is automatically applied when the transmission is in position **P** and:

- the engine is switched off or
- the driver is not wearing a seat belt and the driver's door is opened

To prevent the electric parking brake from being automatically applied, pull handle ①.

The electric parking brake is also engaged automatically if:

- **DISTRONIC PLUS** brings the vehicle to a standstill or
- the **HOLD** function is keeping the vehicle stationary
- **Active Parking Assist** is keeping the vehicle stationary

In addition, at least one of the following conditions must be fulfilled:

- the engine is switched off
- the driver is not wearing a seat belt and the driver's door is opened
- there is a system malfunction
- the power supply is insufficient
- the vehicle is stationary for a lengthy period

The red **PARK** (USA only) or **(P)** (Canada only) indicator lamp in the instrument cluster lights up.

The electric parking brake is not automatically engaged if the engine is switched off by the **ECO** start/stop function.

### Releasing automatically

The electric parking brake is released automatically when all of the following conditions are fulfilled:

- the engine is running.
- the transmission is in position **D** or **R**.

- the seat belt has been fastened
- you depress the accelerator pedal

If the automatic transmission is in position **R**, the trunk lid must be closed.

If your seat belt is not fastened, the following conditions must be fulfilled to automatically release the electric parking brake:

- the driver's door is closed.
- you have shifted out of transmission position **P** or you have previously driven faster than 2 mph (3 km/h).

Ensure that you do not depress the accelerator pedal unintentionally. Otherwise the parking brake will be released and the vehicle will start to move.

### Emergency braking

The vehicle can also be braked during an emergency by using the electric parking brake.

- ▶ While driving, push handle ① of the electric parking brake (> page 190). The vehicle is braked as long as you keep handle ① of the electric parking brake pressed. The longer electric parking brake handle ① is depressed, the greater the braking force.

During braking:

- a warning tone sounds
- the **Please Release Parking Brake** message appears
- the red **PARK** (USA only) or **(P)** (Canada only) indicator lamp in the instrument cluster flashes

When the vehicle has been braked to a standstill, the electric parking brake is engaged.

### Parking the vehicle for a long period

If you leave the vehicle parked for longer than four weeks, the battery may be damaged by exhaustive discharging.

If you leave the vehicle parked for longer than six weeks, the vehicle may suffer damage as a result of lack of use.

- ▶ Visit a qualified specialist workshop and seek advice.

**PLUG-IN HYBRID vehicles:** observe the important safety notes for the high-voltage battery (> page 374).

## Driving tips

### General driving tips

#### Important safety notes

##### WARNING

If you switch off the ignition while driving, safety-relevant functions are only available with limitations, or not at all. This could affect, for example, the power steering and the brake boosting effect. You will require considerably more effort to steer and brake. There is a risk of an accident.

Do not switch off the ignition while driving.

##### WARNING

If you operate mobile communication equipment while driving, you will be distracted from traffic conditions. You could also lose control of the vehicle. There is a risk of an accident.

Only operate this equipment when the vehicle is stationary.

Observe the legal requirements for the country in which you are driving. Some jurisdictions prohibit the driver from using a mobile phone while driving a vehicle.

If you make a call while driving, always use hands-free mode. Only operate the telephone when the traffic situation permits. If you are unsure, pull over to a safe location and stop before operating the telephone.

Bear in mind that at a speed of only 30 mph (approximately 50 km/h), the vehicle covers a distance of 44 ft (approximately 14 m) per second.

### Drive sensibly – save fuel

Observe the following tips to save fuel:

- ▶ The tires should always be inflated to the recommended tire pressure.
- ▶ Remove unnecessary loads.
- ▶ Remove roof racks when they are not needed.
- ▶ Warm up the engine at low engine speeds.
- ▶ Avoid frequent acceleration or braking.
- ▶ Have all maintenance work carried out as indicated by the service intervals in the Main-

tenance Booklet or by the service interval display.

Fuel consumption also increases when driving in cold weather, in stop-start traffic and in hilly terrain.

## Drinking and driving

### WARNING

Drinking and driving and/or taking drugs and driving are very dangerous combinations. Even a small amount of alcohol or drugs can affect your reflexes, perceptions and judgment.

The possibility of a serious or even fatal accident is greatly increased when you drink or take drugs and drive.

Do not drink or take drugs and drive or allow anyone to drive who has been drinking or taking drugs.

## Emission control

### WARNING

Combustion engines emit poisonous exhaust gases such as carbon monoxide. Inhaling these exhaust gases leads to poisoning. There is a risk of fatal injury. Therefore never leave the engine running in enclosed spaces without sufficient ventilation.

Certain engine systems are designed to keep the level of poisonous components in exhaust fumes within legal limits.

These systems only work at peak efficiency if they are serviced exactly in accordance with the manufacturer's specifications. Always have work on the engine carried out at a qualified specialist workshop. Mercedes-Benz recommends that you use an authorized Mercedes-Benz Center for this purpose. In particular, work relevant to safety or on safety-related systems must be carried out at a qualified specialist workshop.

The engine settings must not be changed under any circumstances. Furthermore, all specific service work must be carried out at regular intervals and in accordance with the Mercedes-Benz service requirements. Details can be found in the Maintenance Booklet.

## ECO display



The ECO display provides feedback on how economical your driving characteristics are. The ECO display assists you in achieving the most economical driving style for the selected settings and prevailing conditions. Your driving style can significantly influence the vehicle's consumption.

The ECO display consists of three bars:

- **Accel.**
- **Constant**
- **Coasting**

The percent value is the average value of the three bars. The three bars and the mean value begin at the value of 50%. A higher percentage indicates a more economical driving style.

The ECO display does not indicate the actual fuel consumption. A fixed percentage count in the ECO display does not indicate a fixed consumption.

Apart from driving style, consumption is dependent on many factors such as, e.g.:

- load
- tire pressure
- cold start
- choice of route
- electrical consumers switched on

These factors are not included in the ECO display.

The evaluation of your driving style is carried out using the following three categories:

- **Accel.** (evaluation of all acceleration processes)
  - The bar fills up: moderate acceleration, especially at higher speeds
  - The bar empties: sporty acceleration
- **Constant** (assessment of driving behavior at all times)
  - The bar fills up: constant speed and avoidance of unnecessary acceleration and deceleration
  - The bar empties: fluctuations in speed
- **Coasting** (assessment of all deceleration processes)
  - The bar fills up: anticipatory driving, keeping your distance and early release of the accelerator. The vehicle can coast without use of the brakes.
  - The bar empties: frequent braking

An economical driving style specially requires driving at moderate engine speeds.

To achieve a higher value in the categories **Accel.** and **Constant**,

- observe the gearshift recommendations.
- drive in drive program **E**

On long journeys at a constant speed, e.g. on the highway, only the bar for **Constant** will change.

The ECO display summarizes the driving characteristics from the start of the journey to its completion. For this reason, the bars change dynamically at the beginning of the journey. On longer journeys, there are fewer changes. For more dynamic changes, carry out a manual reset.

For further information on the ECO display, see (▷ page 262).

## Brakes

### Important safety notes

#### WARNING

If you shift down on a slippery road surface in an attempt to increase the engine's braking effect, the drive wheels could lose their grip. There is an increased danger of skidding and accidents.

Do not shift down for additional engine braking on a slippery road surface.

## Downhill gradients

 On long and steep gradients, you must reduce the load on the brakes by shifting to a lower gear in good time. This allows you to take advantage of the engine's braking effect. This helps you to avoid overheating the brakes and wearing them out excessively.

When you take advantage of engine braking, a drive wheel may not turn for some time, e.g. on a slippery road surface. This could cause damage to the drive train. This type of damage is not covered by the Mercedes-Benz warranty.

## Heavy and light loads

#### WARNING

If you rest your foot on the brake pedal while driving, the braking system can overheat. This increases the stopping distance and can even cause the braking system to fail. There is a risk of an accident.

Never use the brake pedal as a footrest. Never depress the brake pedal and the accelerator pedal at the same time.

 Depressing the brake pedal constantly results in excessive and premature wear to the brake pads.

If the brakes have been subjected to a heavy load, do not stop the vehicle immediately. Drive on for a short while. This allows the airflow to cool the brakes more quickly.

## Wet roads

If you have driven for a long time in heavy rain without braking, there may be a delayed reaction from the brakes when braking for the first time. This may also occur after the vehicle has been washed or driven through deep water.

You have to depress the brake pedal more firmly. Maintain a greater distance from the vehicle in front.

After driving on a wet road or having the vehicle washed, brake firmly while paying attention to the traffic conditions. This will warm up the brake discs, thereby drying them more quickly and protecting them against corrosion.

## Limited braking performance on salt-treated roads

If you drive on salted roads, a layer of salt residue may form on the brake discs and brake pads. This can result in a significantly longer braking distance.

- In order to prevent any salt build-up, apply the brakes occasionally while paying attention to the traffic conditions.
- Carefully depress the brake pedal and the beginning and end of a journey.
- Maintain a greater distance to the vehicle ahead.

## Servicing the brakes

**!** The brake fluid level may be too low, if:

- if the red brake warning lamp lights up in the instrument cluster and
- you hear a warning tone while the engine is running

Observe additional warning messages in the multifunction display.

The brake fluid level may be too low due to brake pad wear or leaking brake lines.

Have the brake system checked immediately. Consult a qualified specialist workshop to arrange this.

**!** **Vehicles with 4MATIC:** function or performance tests may only be carried out on a 2-axle dynamometer. If you wish to operate the vehicle on such a dynamometer, please consult a qualified specialist workshop in advance. You could otherwise damage the drive train or the brake system.

**!** **Vehicles with 4MATIC:** the ESP® system operates automatically. The engine and the ignition must therefore be switched off (the SmartKey must be in position **0** or **1** in the ignition lock or the Start/Stop button must be in position **0** or **1**) if the electric parking brake is tested on a brake dynamometer.

Braking triggered automatically by ESP® may cause severe damage to the brake system.

**!** **Vehicles without 4MATIC:** the ESP® system operates automatically. The engine and the ignition must therefore be switched off (the SmartKey must be in position **0** or **1** in the ignition lock or the Start/Stop button must be in position **0** or **1**) if:

- the electric parking brake is tested using a brake dynamometer.
- the vehicle is towed with one axle raised.

Braking triggered automatically by ESP® may cause severe damage to the brake system.

All checks and maintenance work on the brake system must be carried out at a qualified specialist workshop.

Have brake pads installed and brake fluid replaced at a qualified specialist workshop.

If the brake system has only been subject to moderate loads, you should test the functionality of your brakes at regular intervals.

Information on BAS (Brake Assist) (> page 69) and BAS PLUS (Brake Assist PLUS) (> page 69).

For safety reasons, Mercedes-Benz recommends only installing the following brake disks and brake pads/linings:

- brake disks that have been approved by Mercedes-Benz
- brake pads/linings that have been approved by Mercedes-Benz or that are of an equivalent standard of quality

Other brake disks or brake pads/linings can compromise the safety of your vehicle.

Always replace all brake disks and brake pads/linings on an axle at the same time. Always install new brake pads/linings when replacing brake disks.

The vehicle is equipped with lightweight brake disks to which the wheel assembly with rim and threaded connection is matched.

The use of brake disks other than those approved by Mercedes-Benz can change the track width and is subject to approval, if applicable.

Shock-type loads when handling the brake discs, such as when changing wheels, can lead to a reduction in comfort when driving with lightweight brake discs. Avoid shock-type loads on the lightweight brake disks, particularly on the brake plate.

Mercedes-Benz recommends that you only use brake fluid that has been specially approved for your vehicle by Mercedes-Benz, or which corre-

sponds to an equivalent quality standard. Brake fluid which has not been approved for Mercedes-Benz vehicles or which is not of an equivalent quality could affect your vehicle's operating safety.

### AMG high-performance and ceramic brakes

The high-performance brake system is only available on Mercedes-AMG vehicles.

The AMG brake systems are designed for heavy loads. This may lead to noise when braking. This will depend on:

- Speed
- Braking force
- Environmental conditions, such as temperature and humidity

The wear of individual components of the brake system, such as the brake pads/linings or brake discs, depends on the individual driving style and operating conditions.

For this reason, it is impossible to state a mileage that will be valid under all circumstances. An aggressive driving style will lead to high wear. You can obtain more information on this from a qualified specialist workshop.

New and replaced brake pads and discs only reach their optimum braking effect after several hundred kilometers of driving. Compensate for this by applying greater force to the brake pedal. Keep this in mind, and adapt your driving and braking accordingly during this break-in period.

Excessive heavy braking results in correspondingly high brake wear. Observe the brake wear warning lamp in the instrument cluster and note any brake status messages in the multifunction display. Especially for high performance driving, it is important to maintain and have the brake system checked regularly.

### Driving on wet roads

#### Hydroplaning

If water has accumulated to a certain depth on the road surface, there is a danger of hydroplaning occurring, even if:

- you drive at low speeds
- the tires have adequate tread depth

For this reason, in the event of heavy rain or in conditions in which hydroplaning may occur, you must drive in the following manner:

- lower your speed
- avoid ruts
- avoid sudden steering movements
- brake carefully

### Driving on flooded roads

**!** Do not drive through flooded areas. Check the depth of any water before driving through it. Drive slowly through standing water. Otherwise, water may enter the vehicle interior or the engine compartment. This can damage the electronic components in the engine or the automatic transmission. Water can also be drawn in by the engine's air suction nozzles and this can cause engine damage.

### Winter driving

#### WARNING

If you shift down on a slippery road surface in an attempt to increase the engine's braking effect, the drive wheels could lose their grip. There is an increased danger of skidding and accidents.

Do not shift down for additional engine braking on a slippery road surface.

#### DANGER

If the exhaust pipe is blocked or adequate ventilation is not possible, poisonous gases such as carbon monoxide (CO) may enter the vehicle. This is the case, e.g. if the vehicle becomes trapped in snow. There is a risk of fatal injury.

If you leave the engine or the auxiliary heating running, make sure the exhaust pipe and area around the vehicle are clear of snow. To ensure an adequate supply of fresh air, open a window on the side of the vehicle that is not facing into the wind.

Have your vehicle winter-proofed at a qualified specialist workshop at the onset of winter.

Drive particularly carefully on slippery road surfaces. Avoid sudden acceleration, steering and braking maneuvers. Do not use the cruise control or DISTRONIC PLUS.

If the vehicle threatens to skid or cannot be stopped when moving at low speed:

► Shift the transmission to position **N**.

The outside temperature indicator is not designed to serve as an ice-warning device and is therefore unsuitable for that purpose. Changes in the outside temperature are displayed after a short delay.

Indicated temperatures just above the freezing point do not guarantee that the road surface is free of ice. The road may still be icy, especially in wooded areas or on bridges.

You should pay special attention to road conditions when temperatures are around freezing point.

For more information on driving with snow chains, see (▷ page 386).

For more information on driving with summer tires, see (▷ page 386).

Observe the notes in the "Winter operation" section (▷ page 386).

## Driving systems

### Mercedes-Benz Intelligent Drive

Mercedes-Benz Intelligent Drive stands for innovative driver assistance and safety systems which enhance comfort and support the driver in critical situations. With these intelligent co-ordinated systems Mercedes-Benz has set a milestone on the path towards autonomous driving. Mercedes-Benz Intelligent Drive embraces all elements of active and passive safety in one well thought out system – for the safety of the vehicle occupants and that of other road users.

Further information on driving safety systems (▷ page 68).

### Cruise control

#### General notes

Cruise control maintains a constant road speed for you. It brakes automatically in order to avoid exceeding the set speed. Change into a lower gear in good time on long and steep downhill

gradients. This is especially important if the vehicle is laden. By doing so, you will make use of the braking effect of the engine. This relieves the load on the brake system and prevents the brakes from overheating and wearing too quickly.

You can use cruise control if you want to drive at a steady speed for a prolonged period of time. You can store any road speed above 20 mph (30 km/h).

#### Important safety notes

If you fail to adapt your driving style, cruise control can neither reduce the risk of an accident nor override the laws of physics. Cruise control cannot take into account the road, traffic and weather conditions. Cruise control is only an aid. You are responsible for the distance to the vehicle in front, for vehicle speed, for braking in good time and for staying in your lane.

Do not use cruise control:

- in road and traffic conditions which do not allow you to maintain a constant speed, e.g. in heavy traffic or on winding roads
- on slippery road surfaces. Braking or accelerating could cause the drive wheels to lose traction and the vehicle could then skid
- when there is poor visibility, e.g. due to fog, heavy rain or snow

If there is a change of drivers, advise the new driver of the speed stored.

#### Cruise control lever

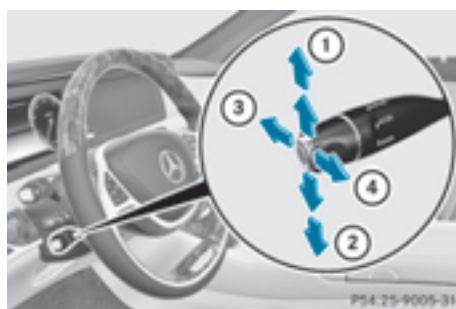

- ① To activate or increase speed
- ② To activate or reduce speed
- ③ To deactivate cruise control
- ④ To activate at the current speed/last stored speed

When you activate cruise control, the stored speed is shown in the multifunction display for five seconds. In the speedometer, the segments between the stored speed and the maximum speed light up.

### Storing and maintaining the current speed



You can store the current speed if you are driving faster than 20 mph (30 km/h).

- ▶ Accelerate the vehicle to the desired speed.
- ▶ Briefly press the cruise control lever up ① or down ②.
- ▶ Remove your foot from the accelerator pedal. Cruise control is activated. The vehicle automatically maintains the stored speed.

**i** Cruise control may be unable to maintain the stored speed on uphill gradients. The stored speed is resumed when the gradient evens out. Cruise control maintains the stored speed on downhill gradients by automatically applying the brakes.

### Calling up the last speed stored

#### WARNING

If you call up the stored speed and it is lower than the current speed, the vehicle decelerates. If you do not know the stored speed, the vehicle could decelerate unexpectedly. There is a risk of an accident.

Pay attention to the road and traffic conditions before calling up the stored speed. If you do not know the stored speed, store the desired speed again.



- ▶ Briefly pull the cruise control lever towards you ①.
- ▶ Remove your foot from the accelerator pedal. The first time cruise control is activated, it stores the current speed or regulates the speed of the vehicle to the previously stored speed.

### Setting a speed



Keep in mind that it may take a brief moment until the vehicle has accelerated or braked to the speed set.

- ▶ Press the cruise control lever up ① for a higher speed or down ② for a lower speed.
- ▶ **To adjust the set speed in 1 mph increments (1 km/h increments):** briefly press the cruise control lever up ① or down ② to the pressure point. Every time the cruise control lever is pressed up ① or down ② the last speed stored is increased or reduced.
- ▶ **To adjust the set speed in 5 mph increments (10 km/h increments):** briefly press the cruise control lever up ① or down ② to the pressure point. Every time the cruise control lever is pressed up ① or down ② the last speed stored is increased or reduced.



- i** Cruise control is not deactivated if you depress the accelerator pedal. If you accelerate to overtake, cruise control adjusts the vehicle's speed to the last speed stored after you have finished overtaking.

## Deactivating cruise control



There are several ways to deactivate cruise control:

- ▶ Briefly press cruise the control lever forwards ①.

or

- ▶ Brake.

Cruise control is automatically deactivated if:

- you engage the electric parking brake
- you are driving at less than 20 mph (30 km/h)
- ESP® intervenes or you deactivate ESP®
- you shift the transmission to position **N** while driving

If cruise control is deactivated, you will hear a warning tone. You will see the **Cruise Control Off** message in the multifunction display for approximately five seconds.

- i** When you switch off the engine, the last speed stored is cleared.

## DISTRONIC PLUS

### General notes

DISTRONIC PLUS regulates the speed and automatically helps you maintain the distance to the vehicle detected in front. Vehicles are detected with the aid of the radar sensor system. DISTRONIC PLUS brakes automatically so that the set speed is not exceeded.

Change into a lower gear in good time on long and steep downhill gradients. This is especially important if the vehicle is laden. By doing so, you will make use of the braking effect of the engine. This relieves the load on the brake system and prevents the brakes from overheating and wearing too quickly.

If DISTRONIC PLUS detects that there is a risk of a collision, you will be warned visually and acoustically. DISTRONIC PLUS cannot prevent a collision without your intervention. An intermittent warning tone will then sound and the distance warning lamp will light up in the instrument cluster. Brake immediately in order to increase the distance to the vehicle in front or take evasive action provided it is safe to do so. DISTRONIC PLUS operates in range between 0 mph (0 km/h) and 120 mph (200 km/h).

Do not use DISTRONIC PLUS while driving on roads with steep gradients.

As DISTRONIC PLUS transmits radar waves, it can resemble the radar detectors of the responsible authorities. You can refer to the relevant chapter in the Operator's Manual if questions are asked about this.

- i** USA only: This device has been approved by the FCC as a "Vehicular Radar System". The radar sensor is intended for use in an automotive radar system only. Removal, tampering, or altering of the device will void any warranties, and is not permitted by the FCC. Do not tamper with, alter, or use in any non-approved way.

Any unauthorized modification to this device could void the user's authority to operate the equipment.

- i** Canada only: This device complies with RSS-210 of Industry Canada. Operation is subject to the following two conditions:
  1. This device may not cause harmful interference, and
  2. This device must accept any interference received, including interference that may cause undesired operation of the device.

Removal, tampering, or altering of the device will void any warranties, and is not permitted. Do not tamper with, alter, or use in any non-approved way.

Any unauthorized modification to this device could void the user's authority to operate the equipment.

## Important safety notes

### WARNING

DISTRONIC PLUS does not react to:

- people or animals
- stationary obstacles on the road, e.g. stopped or parked vehicles
- oncoming and crossing traffic

As a result, DISTRONIC PLUS may neither give warnings nor intervene in such situations.

There is a risk of an accident.

Always pay careful attention to the traffic situation and be ready to brake.

### WARNING

DISTRONIC PLUS cannot always clearly identify other road users and complex traffic situations.

In such cases, DISTRONIC PLUS may:

- give an unnecessary warning and then brake the vehicle
- neither give a warning nor intervene
- accelerate or brake unexpectedly

There is a risk of an accident.

Continue to drive carefully and be ready to brake, in particular when warned to do so by DISTRONIC PLUS.

### WARNING

DISTRONIC PLUS brakes your vehicle with up to 50% of the maximum possible deceleration. If this braking force is insufficient, DISTRONIC PLUS warns you visually and audibly. There is a risk of an accident.

In such cases, apply the brakes yourself and try to take evasive action.

**!** If DISTRONIC PLUS or the HOLD function is activated, the vehicle brakes automatically in certain situations.

To prevent damage to the vehicle, deactivate DISTRONIC PLUS and the HOLD function in the following or other similar situations:

- when towing the vehicle
- in the car wash

If you fail to adapt your driving style, DISTRONIC PLUS can neither reduce the risk of accident nor override the laws of physics. DISTRONIC PLUS cannot take into account the road, traffic and weather conditions. DISTRONIC PLUS is only an aid. You are responsible for the distance to the vehicle in front, for vehicle speed, for braking in good time and for staying in your lane.

Do not use DISTRONIC PLUS:

- in road and traffic conditions which do not allow you to maintain a constant speed, e.g. in heavy traffic or on winding roads
- on slippery road surfaces. Braking or accelerating could cause the drive wheels to lose traction and the vehicle could then skid
- when there is poor visibility, e.g. due to fog, heavy rain or snow

DISTRONIC PLUS may not detect narrow vehicles driving in front, e.g. motorcycles, or vehicles driving on a different line.

In particular, the detection of obstacles can be impaired if:

- there is dirt on the sensors or anything else covering the sensors
- there is snow or heavy rain
- there is interference by other radar sources
- there are strong radar reflections, for example, in parking garages

If DISTRONIC PLUS no longer detects a vehicle in front, DISTRONIC PLUS may unexpectedly accelerate the vehicle to the stored speed.

This speed may:

- be too high if you are driving in a filter lane or an exit lane
- be so high in the right lane that you pass vehicles driving on the left (left-hand drive countries)
- be so high in the left lane that you pass vehicles driving on the right (right-hand drive countries)

If there is a change of drivers, advise the new driver of the speed stored.

## Cruise control lever

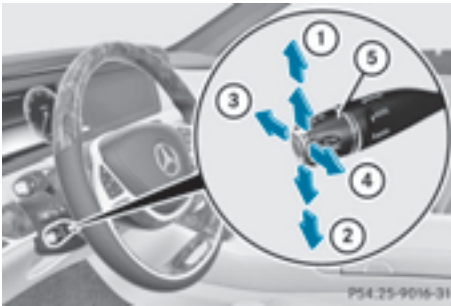

- ① To activate or increase speed
- ② To activate or reduce speed
- ③ To deactivate DISTRONIC PLUS
- ④ To activate at the current speed/last stored speed
- ⑤ To set the specified minimum distance

## Activating DISTRONIC PLUS

### Activation conditions

In order to activate DISTRONIC PLUS, the following conditions must be fulfilled:

- the engine must be started. It may take up to two minutes after pulling away before DISTRONIC PLUS is operational.
- the electric parking brake must be released.
- ESP® must be active, but not intervening.
- Active Parking Assist must not be activated.
- the transmission must be in position **D**.
- the driver's door must be closed when you shift from **P** to **D** or your seat belt must be fastened.
- the front-passenger door and rear doors must be closed.

## Activating

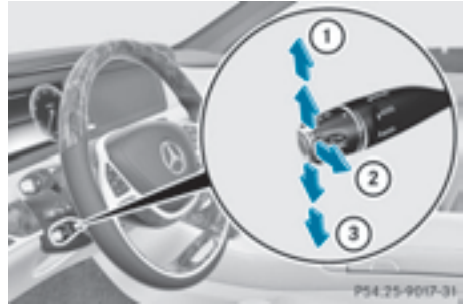

- ▶ Briefly pull the cruise control lever towards you ②, up ① or down ③ . DISTRONIC PLUS is selected.
- ▶ **To adjust the set speed in 1 mph increments (1 km/h increments):** briefly press the cruise control lever up ① to the pressure point for a higher speed, or down ③ for a lower speed. Every time the cruise control lever is pressed up or down, the last speed stored is increased or reduced.

or

- ▶ **To adjust the set speed in 5 mph increments (10 km/h increments):** briefly press the cruise control lever up ① past the pressure point for a higher speed, or down ③ for a lower speed. Every time the cruise control lever is pressed up or down, the last speed stored is increased or reduced.
- ▶ Remove your foot from the accelerator pedal. Your vehicle adapts its speed to that of the vehicle in front, but only up to the desired stored speed.

**i** If you do not fully release the accelerator pedal, the **DISTRONIC PLUS Suspended** message appears in the multifunction display. The set distance to a slower-moving vehicle in front will then not be maintained. You will be driving at the speed you determine by the position of the accelerator pedal.

You can also activate DISTRONIC PLUS when stationary. The lowest speed that can be set is 20 mph (30 km/h).

- ▶ Briefly pull the cruise control lever towards you ② or press it up ① or down ③. DISTRONIC PLUS is selected.

### Activating at the current speed/last stored speed

#### WARNING

If you call up the stored speed and it differs from the current speed, the vehicle accelerates or decelerates. If you do not know the stored speed, the vehicle could accelerate or brake unexpectedly. There is a risk of an accident.

Pay attention to the road and traffic conditions before calling up the stored speed. If you do not know the stored speed, store the desired speed again.



- ▶ Briefly pull the cruise control lever towards you ①.
- ▶ Remove your foot from the accelerator pedal. DISTRONIC PLUS is activated. The first time it is activated, the current speed is stored. Otherwise, it sets the vehicle cruise speed to the previously stored value.

### Driving with DISTRONIC PLUS

#### Pulling away and driving



- ▶ If you want to pull away with DISTRONIC PLUS: remove your foot from the brake pedal.

- ▶ Briefly pull the cruise control lever towards you ①.

or

- ▶ Accelerate briefly.

Your vehicle pulls away and adapts its speed to that of the vehicle in front. If no vehicle is detected in front, your vehicle accelerates to the set speed.

The vehicle can also pull away when it is facing an unidentified obstacle or is driving on a different line from another vehicle. The vehicle then brakes automatically. Be ready to brake at all times.

If there is no vehicle in front, DISTRONIC PLUS operates in the same way as cruise control.

If DISTRONIC PLUS detects that the vehicle in front has slowed down, it brakes your vehicle. In this way, the distance you have selected is maintained.

If DISTRONIC PLUS detects a faster-moving vehicle in front, it increases the driving speed. However, the vehicle is only accelerated up to the speed you have stored.

#### Selecting the drive program

##### All vehicles (except AMG vehicles):

DISTRONIC PLUS supports a sporty driving style when you select the **S** drive program (▷ page 173). Acceleration behind the vehicle in front or to the set speed is then noticeably more dynamic. If you have selected the **E** driving program, the vehicle accelerates more gently. This setting is recommended in stop-and-start traffic.

**AMG vehicles:** DISTRONIC Plus supports a sporty driving style when you select the **S** or **M** drive program (▷ page 173). Acceleration behind the vehicle in front or to the set speed is then noticeably more dynamic. When you select the **C** drive program, the vehicle accelerates more gently. This setting is recommended in stop-and-start traffic.

#### Changing lanes

If you change to the passing lane, DISTRONIC PLUS supports you when:

- you are driving faster than 45 mph (70 km/h)
- you switch on the appropriate turn signal
- DISTRONIC PLUS does not detect a danger of collision

If these conditions are fulfilled, your vehicle is accelerated. Acceleration will be interrupted if changing lanes takes too long or if the distance between your vehicle and the vehicle in front becomes too small.

- i** When you change lanes, DISTRONIC PLUS monitors the left lane on left-hand-drive vehicles or the right lane on right-hand-drive vehicles.

## Stopping

### WARNING

When leaving the vehicle, even if it is braked only by DISTRONIC PLUS, it could roll away if:

- there is a malfunction in the system or in the voltage supply.
- DISTRONIC PLUS has been deactivated with the cruise control lever, e.g. by a vehicle occupant or from outside the vehicle.
- the electrical system in the engine compartment, the battery or the fuses have been tampered with.
- the battery is disconnected.
- the accelerator pedal has been depressed, e.g. by a vehicle occupant.

There is a risk of an accident.

If you wish to exit the vehicle, always turn off DISTRONIC PLUS and secure the vehicle against rolling away.

For further information on deactivating DISTRONIC PLUS (▷ page 205).

If DISTRONIC PLUS detects that the vehicle in front is stopping, it brakes your vehicle until it is stationary.

Once your vehicle is stationary, it remains stationary and you do not need to depress the brake.

After a time, the electric parking brake secures the vehicle and relieves the service brake.

Depending on the specified minimum distance, your vehicle will come to a standstill at a sufficient distance behind the vehicle in front. The specified minimum distance is set using the control on the cruise control lever.

When DISTRONIC PLUS is activated, the transmission is shifted automatically to position **P** if:

- the driver's seat belt is not fastened and the driver's door is open.
- the engine is switched off, unless it is automatically switched off by the ECO start/stop function.

The electric parking brake secures the vehicle automatically if DISTRONIC PLUS is activated when the vehicle is stationary and:

- a system malfunction occurs.
- the power supply is not sufficient.

If a malfunction in the electric parking brake occurs, then the transmission may also be shifted into position **P** automatically.

## Setting a speed

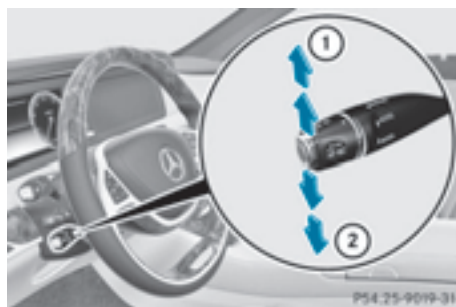

- ▶ Press the cruise control lever up ① for a higher speed or down ② for a lower speed.
- ▶ **To adjust the set speed in 1 mph increments (1 km/h increments):** briefly press the cruise control lever up ① or down ② to the pressure point. Every time the cruise control lever is pressed up ① or down ② the last speed stored is increased or reduced.
- ▶ **To adjust the set speed in 5 mph increments (10 km/h increments):** briefly press the cruise control lever up ① or down ② to the pressure point. Every time the cruise control lever is pressed up ① or down ②, the last speed stored is increased or reduced.

- i** If you accelerate to overtake, DISTRONIC PLUS adjusts the vehicle's speed to the last speed stored after you have finished overtaking.

## Setting a specified minimum distance

You can set the specified minimum distance for DISTRONIC PLUS by varying the time span between one and two seconds. With this function, you can set the minimum distance that DISTRONIC PLUS keeps to the vehicle in front, dependent on vehicle speed. You can see this distance in the multifunction display (▷ page 204).

- i** Make sure that you maintain the minimum distance to the vehicle in front as required by law. Adjust the distance to the vehicle in front if necessary.



- ▶ **To increase:** turn control ② in direction ③. DISTRONIC PLUS then maintains a greater distance between your vehicle and the vehicle in front.
- ▶ **To decrease:** turn control ② in direction ①. DISTRONIC PLUS then maintains a shorter distance between your vehicle and the vehicle in front.

## DISTRONIC PLUS displays in the instrument cluster

### Displays in the speedometer



When you switch on DISTRONIC PLUS, triangle ② shows the stored speed.

If DISTRONIC PLUS detects a vehicle in front, segments between the speed of the vehicle in front ① and stored speed ② light up. The segments likewise light up if a vehicle in front is detected in the fast lane.

- i** For design reasons, the speed displayed in the speedometer may differ slightly from the speed set for DISTRONIC PLUS.

## Display when DISTRONIC PLUS is deactivated



- ① Vehicle in front, if detected
- ② Distance indicator, current distance to the vehicle in front
- ③ Specified minimum distance to the vehicle in front; adjustable
- ④ Own vehicle

In the Assistance menu (▷ page 269) of the on-board computer, you can select the assistance graphics display.

- ▶ Select the **Assistance Graphic** function using the on-board computer (▷ page 268).

## Display when DISTRONIC PLUS is activated



- ① DISTRONIC PLUS active (text only appears when the cruise control lever is actuated)
- ② Vehicle in front, if detected
- ③ Specified minimum distance to the vehicle in front; adjustable
- ④ Own vehicle

In the Assistance menu (▷ page 269) of the on-board computer, you can select the assistance graphics display.

- ▶ Select the **Assistance Graphic** function using the on-board computer (▷ page 268).

You will see the stored speed for about five seconds when you activate DISTRONIC PLUS.

## Deactivates DISTRONIC PLUS



There are several ways to deactivate DISTRONIC PLUS:

- ▶ Briefly press the cruise control lever forwards ①

or

- ▶ Brake, unless the vehicle is stationary

When you deactivate DISTRONIC PLUS, you will see the **DISTRONIC PLUS Off** message in the

multifunction display for approximately five seconds.

- ❗ The last speed stored remains stored until you switch off the engine.
- ❗ DISTRONIC PLUS is not deactivated if you depress the accelerator pedal.

DISTRONIC PLUS is automatically deactivated if:

- you engage the electric parking brake or if the vehicle is automatically secured with the electric parking brake
- ESP® intervenes or you deactivate ESP®
- the transmission is in the **P**, **R** or **N** position
- you pull the cruise control lever towards you in order to pull away and the front-passenger door or one of the rear doors is open
- the vehicle has skidded
- you activate Active Parking Assist

If DISTRONIC PLUS is deactivated, you will hear a warning tone. You will see the **DISTRONIC PLUS Off** message in the multifunction display for approximately five seconds.

## Tips for driving with DISTRONIC PLUS

### General notes

Pay particular attention in the following traffic situations:

- Cornering, going into and coming out of a bend
- Vehicles traveling on a different line
- Other vehicles changing lanes
- Narrow vehicles
- Obstructions and stationary vehicles
- Crossing vehicles

In such situations, brake if necessary. DISTRONIC PLUS is then deactivated.

### Cornering, going into and coming out of a bend

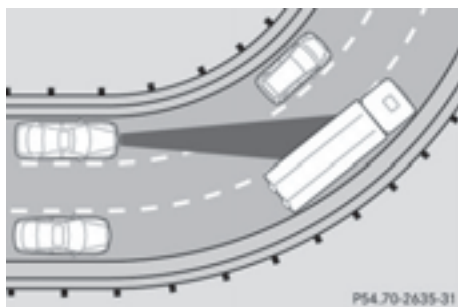

The ability of DISTRONIC PLUS to detect vehicles when cornering is limited. Your vehicle may brake unexpectedly or late.

### Vehicles traveling on a different line

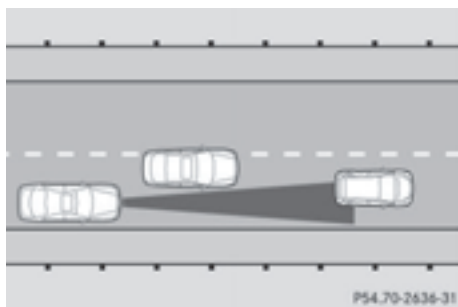

DISTRONIC PLUS may not detect vehicles traveling on a different line. The distance to the vehicle in front will be too short.

### Other vehicles changing lanes

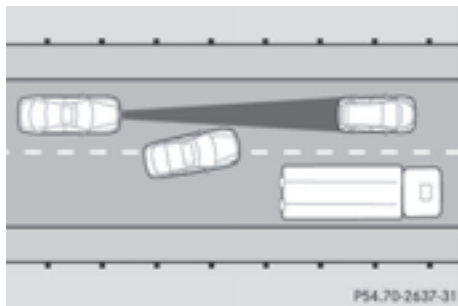

DISTRONIC PLUS has not detected the vehicle cutting in yet. The distance to this vehicle will be too short.

### Narrow vehicles

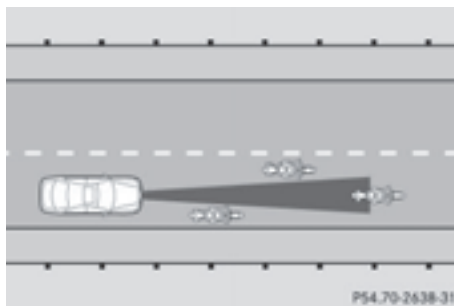

DISTRONIC PLUS has not yet detected the vehicle in front on the edge of the road, because of its narrow width. The distance to the vehicle in front will be too short.

### Obstructions and stationary vehicles

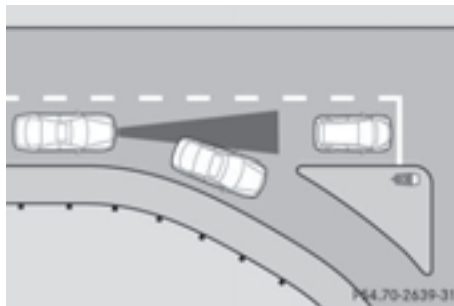

DISTRONIC PLUS does not brake for obstacles or stationary vehicles. If, for example, the detected vehicle turns a corner and reveals an obstacle or stationary vehicle, DISTRONIC PLUS will not brake for these.

### Crossing vehicles

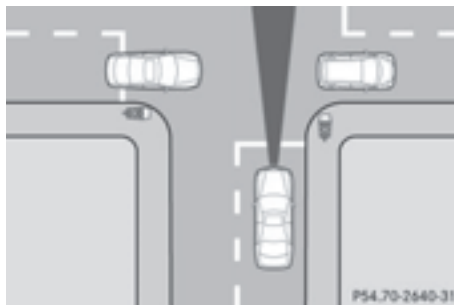

DISTRONIC PLUS may mistakenly detect vehicles that are crossing your lane. Activating



DISTRONIC PLUS at traffic lights with crossing traffic, for example, could cause your vehicle to pull away unintentionally.

## DISTRONIC PLUS with Steering Assist and Stop&Go Pilot

### General notes



DISTRONIC PLUS with Steering Assist and Stop&Go Pilot aids you in keeping the vehicle in the center of the driving lane by means of moderate steering interventions at speeds of 0 - 125 mph (0 - 200 km/h).

It monitors the area in front of your vehicle by means of multifunction camera ①, at the top of the windshield.

At speeds of 0 - 37 mph (0 - 60 km/h), Stop&Go Pilot focuses on the vehicle in front, taking into account lane markings, e.g. when following vehicles in a traffic jam.

At speeds of more than 37 mph (60 km/h) Steering Assist focuses on detected lane markings (left and right), and only on the vehicle in front if lane markings are missing.

Steering Assist and Stop&Go Pilot do not provide any support if these conditions do not exist. DISTRONIC PLUS must be active in order for the function to be available.

### Important safety notes

If you fail to adapt your driving style, DISTRONIC PLUS with Steering Assist and Stop&Go Pilot can neither reduce the risk of an accident nor override the laws of physics. It cannot take account of road, weather and traffic conditions. DISTRONIC PLUS with Steering Assist and Stop&Go Pilot is only an aid. You are responsible for the distance to the vehicle in front, for vehicle speed, for braking in good time and for staying in your lane.

DISTRONIC PLUS with Steering Assist and Stop&Go Pilot does not detect road and traffic conditions. If you are following a vehicle which is driving towards the edge of the road, your vehicle could come into contact with the curb or other road boundaries. Be particularly aware of other road users, e.g. cyclists, that are directly next to your vehicle.

Obstacles such as building site huts on the lane or projecting out into the lane are not detected.

An inappropriate steering intervention, e.g. after intentionally driving over a lane marking, can be corrected at any time if you steer slightly in the opposite direction.

DISTRONIC PLUS with Steering Assist and Stop&Go Pilot cannot continuously keep your vehicle in lane. In some cases, the steering intervention is not sufficient to bring the vehicle back to the lane. In such cases, you must steer the vehicle yourself to ensure that it does not leave the lane.

The support provided by the system can be impaired if:

- there is poor visibility, e.g. due to insufficient illumination of the road, or due to snow, rain, fog or spray
- there is glare, e.g. from oncoming traffic, the sun or reflections (e.g. when the road surface is wet)
- the windshield is dirty, fogged up, damaged or covered, for instance by a sticker, in the vicinity of the camera
- there are no, several or unclear lane markings for a lane, e.g. in areas with road construction work
- the lane markings are worn away, dark or covered up, e.g. by dirt or snow
- the distance to the vehicle in front is too small and the lane markings thus cannot be detected
- the lane markings change quickly, e.g. lanes branch off, cross one another or merge
- the road is narrow and winding
- there are strong shadows cast on the road

The system is switched to passive and no longer assists you by performing steering interventions if:

- you actively change lane
- you switch on the turn signal
- take your hands off the steering wheel or do not steer for a prolonged period of time

**i** Steering Assist and Stop&Go Pilot are activated again automatically after a lane change is completed.

Steering Assist and Stop&Go Pilot do not provide any support:

- on very sharp corners
- when a loss of tire pressure or a defective tire has been detected and displayed

Pay attention also to the important safety notes for DISTRONIC PLUS (> page 200).

The steering interventions are carried out with a limited steering moment. The system requires the driver to keep his hands on the steering wheel and to steer himself.

If you do not steer yourself or if you take your hands off the steering wheel for a prolonged period of time, the system will first alert you with a visual warning. A steering wheel symbol appears in the multifunction display. If you have still not started to steer and have not taken hold of the steering wheel after five seconds at the latest, a warning tone also sounds to remind you to take control of the vehicle. Steering Assist and Stop&Go Pilot are switched to passive. DISTRONIC PLUS remains active.

### Activating Steering Assist and Stop&Go Pilot

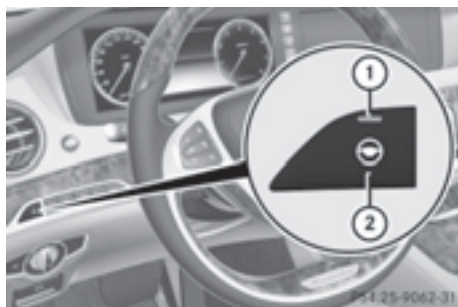

- ▶ Press button ②. Indicator lamp ① lights up. The **DTR+: Steering Assist. On** message appears in the multifunction display. Steering Assist and Stop&Go Pilot are activated.

### Information in the multifunction display



If Steering Assist and Stop&Go Pilot are activated but not ready for a steering intervention, steering wheel symbol ① appears in gray. If the system provides you with support by means of steering interventions, symbol ① is shown in green.

### Deactivating Steering Assist and Stop&Go Pilot

- ▶ Press button ②. Indicator lamp ① goes out. The **DTR+: Steering Assist. Off** message appears in the multifunction display. Steering Assist and Stop&Go Pilot are deactivated.

When DISTRONIC PLUS is deactivated or not available, Steering Assist and Stop&Go Pilot are deactivated automatically.

### HOLD function

#### General notes

The HOLD function can assist the driver in the following situations:

- when pulling away, especially on steep slopes
- when maneuvering on steep slopes
- when waiting in traffic

The vehicle is kept stationary without the driver having to depress the brake pedal.

The braking effect is canceled and the HOLD function deactivated when you depress the accelerator pedal to pull away.

## Important safety notes

### WARNING

When leaving the vehicle, it can still roll away despite being braked by the HOLD function if:

- there is a malfunction in the system or in the voltage supply.
- the HOLD function has been deactivated by pressing the accelerator pedal or the brake pedal, e.g. by a vehicle occupant.
- the electrical system in the engine compartment, the battery or the fuses have been tampered with.
- the battery is disconnected

There is a risk of an accident.

If you wish to exit the vehicle, always turn off the HOLD function and secure the vehicle against rolling away.

Further information on deactivating the HOLD function (▷ page 209).

**!** If DISTRONIC PLUS or the HOLD function is activated, the vehicle brakes automatically in certain situations.

To prevent damage to the vehicle, deactivate DISTRONIC PLUS and the HOLD function in the following or other similar situations:

- when towing the vehicle
- in the car wash

## Activation conditions

You can activate the HOLD function if all of the following conditions are fulfilled:

- the vehicle is stationary.
- the engine is running or if it has been automatically switched off by the ECO start/stop function.
- the driver's door is closed or your seat belt is fastened.
- the electric parking brake is released.
- the transmission is in position **D**, **R** or **N**.
- DISTRONIC PLUS is deactivated.

## Activating the HOLD function



- ▶ Make sure that the activation conditions are met.
- ▶ Depress the brake pedal.
- ▶ Quickly depress the brake pedal further until ① appears in the multifunction display. The HOLD function is activated. You can release the brake pedal.

**i** If depressing the brake pedal the first time does not activate the HOLD function, wait briefly and then try again.

## Deactivating the HOLD function

The HOLD function is deactivated automatically if:

- you accelerate and the transmission is in position **D** or **R**.
- you shift the transmission to position **P**.
- you depress the brake pedal again with a certain amount of pressure until **HOLD** disappears from the multifunction display.
- you secure the vehicle using the electric parking brake.
- you activate DISTRONIC PLUS.

**i** After a time, the electric parking brake secures the vehicle and relieves the service brake. The HOLD function is then deactivated.

When the HOLD function is activated, the transmission is shifted automatically to position **P** if:

- the driver's seat belt is not fastened and the driver's door is open.
- the engine is switched off, unless it is automatically switched off by the ECO start/stop function.

The electric parking brake secures the vehicle automatically if the HOLD function is activated when the vehicle is stationary and:

- a system malfunction occurs.
- the power supply is not sufficient.

If a malfunction in the electric parking brake occurs, then the transmission may also be shifted into position **P** automatically.

## MAGIC BODY CONTROL

### General notes

MAGIC BODY CONTROL consists of Active Body Control (ABC), ROAD SURFACE SCAN as well as automatic vehicle stabilization in the event of a crosswind.

Your vehicle automatically adjusts its ride height to improve driving safety and reduce fuel consumption. The suspension mode is adjusted according to your selection (sports or comfort), the road surface conditions and the vehicle load. A multifunction camera detects bumps in the road surface before the vehicle drives over them. This reduces chassis movements.

### Important safety notes

#### WARNING

When the vehicle is being lowered, people could become trapped if their limbs are between the vehicle body and the wheels or underneath the vehicle. There is a risk of injury.

Make sure no one is underneath the vehicle or in the immediate vicinity of the wheel arches when the vehicle is being lowered.

- ❗ The vehicle is lowered when the engine is switched off. When parking, position your vehicle so that it does not make contact with the curb as the vehicle is lowered. Your vehicle could otherwise be damaged.

### Crosswind Assist

The crosswind stabilization operates by changing wheel loads through adjusting the ABC spring struts. It reduces impairments in handling when driving in a straight line and assists during countersteering.

Crosswind Assist is active in the speed range between 50 mph (80 km/h) and 130 mph (210 km/h) when driving straight ahead or cornering gently.

## Active Body Control ABC

### Vehicle level

**All vehicles except AMG vehicles:** depending on the vehicle level that has been set, the vehicle automatically adjusts its height dependent on the current speed. The vehicle is lowered by up to 0.6 in (15 mm) as the speed increases. As the speed is reduced, the vehicle is raised up to the set vehicle height.

**AMG vehicles:** depending on the vehicle level that has been selected, the vehicle automatically adjusts its height dependent on the current speed. The vehicle is lowered by up to 0.4 in (10 mm) below the normal level as the speed increases. As the speed is reduced, the vehicle is raised up to the set vehicle height.

Select the "Normal" setting for normal road conditions and "Raised" for driving with snow chains or in particularly poor road conditions.



Setting the vehicle level

- ▶ **To raise the vehicle:** press button ①. Indicator lamp ② lights up.
- ▶ **To lower the vehicle:** press button ① again. Indicator lamp ② goes out.

Your selection remains stored even if you remove the SmartKey from the ignition lock.

### Suspension tuning

The electronically controlled ABC suspension system detects the vehicle level and the vehicle load and adjusts the setting accordingly. You can also choose between a particularly sporty or a comfortable tuning.

The ABC suspension system is tuned individually to each wheel and depends on:

- your driving style, e.g. sporty
- the road surface condition, e.g. bumps
- your individual selection, i.e. sports or comfort
- the vehicle load
- the force of the side wind

Your selection remains stored even if you remove the SmartKey from the ignition lock.

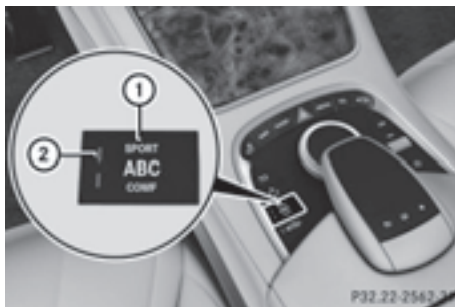

The firmer setting of the suspension tuning in SPORT mode ensures even better contact with the road. The steering response behavior is sporty. Select this mode when employing a sporty driving style on flat roads, e.g. on highways.

Selecting the sports suspension setting

- ▶ **When indicator lamp ② is off:** press button ① repeatedly until only indicator lamp ② is on.  
Sports suspension tuning is selected.

**All vehicles except AMG vehicles:** the **Active Body Control SPORT** message appears in the multifunction display.

**AMG vehicles:** the **AMG Suspension System SPORT** message appears in the multifunction display.

In COMFORT mode, the driving characteristics of your vehicle are especially comfortable. The steering response behavior is balanced. Select this mode if you favor a comfortable driving style.

Selecting the comfortable suspension setting

- ▶ **When indicator lamp ② is off:** press button ① repeatedly until only indicator lamp ② is on.  
Comfortable suspension tuning is selected.

**All vehicles except AMG vehicles:** the **Active Body Control COMFORT** message appears in the multifunction display.

**AMG vehicles:** the **AMG Suspension System COMFORT** message appears in the multifunction display.

## ROAD SURFACE SCAN

- ① This function is not available in all countries.



The ROAD SURFACE SCAN function monitors the road in front of the vehicle using multifunction camera ① at the top of the windshield. This function is automatically active if you select comfort suspension tuning. The system is operational at speeds of up to 81 mph (130 km/h).

This function allows bumps in the road surface to be detected before the vehicle drives over them. The spring struts are then actuated, with the result that chassis movements are significantly reduced when driving over bumps.

The system is deactivated when you select the raised vehicle level or sports mode.

The system may be impaired or may not function if:

- the road surface is insufficiently lit
- there is poor visibility, e.g. snow, rain, fog or spray
- there is glare, e.g. from the sun or from oncoming traffic
- the windshield is dirty, fogged up or covered, for instance by a sticker, in the vicinity of the camera
- the road surface has no texture or is reflective, e.g. in the case of newly laid asphalt, concrete slabs or puddles
- the distance to the vehicle in front is too short

- sections of the route have a very small radius of curvature
- you accelerate hard or brake sharply

## AIRMATIC

### General notes

AIRMATIC is an air suspension with variable damping for improved driving comfort. All-round level control ensures the best possible suspension and constant ground clearance, even with a laden vehicle. When you drive fast, the vehicle is lowered automatically to improve driving safety and to reduce fuel consumption. There is also the option to manually adjust the vehicle level. AIRMATIC consists of level setting, level control and the Adaptive Damping System ADS PLUS.

### Important safety notes

#### WARNING

When the vehicle is being lowered, people could become trapped if their limbs are between the vehicle body and the wheels or underneath the vehicle. There is a risk of injury.

Make sure no one is underneath the vehicle or in the immediate vicinity of the wheel arches when the vehicle is being lowered.

### Vehicle level

#### Setting the raised vehicle level



It is possible to choose between the "Normal" and "Raised" vehicle levels. Select the "Normal" setting for normal road surfaces and "Raised" for driving with snow chains or on particularly

poor road surfaces. Your selection remains stored even if you remove the SmartKey from the ignition lock.

- ▶ Start the engine.

If indicator lamp ② is not lit:

- ▶ Press button ①.  
Indicator lamp ② lights up. The vehicle is raised by 1.0 in (25 mm) compared to the normal level.

The **Vehicle Rising** message appears in the multifunction display.

- i** The message disappears after ten seconds, irrespective of the level reached. If necessary, the vehicle is raised further.

The "Raised level" setting is canceled if you:

- drive at a speed above approximately 75 mph (120 km/h)
- drive for approximately three minutes at a speed above 50 mph (80 km/h)

#### Setting the normal vehicle level

- ▶ Start the engine.

If indicator lamp ② is lit:

- ▶ Press button ①.  
Indicator lamp ② goes out. The vehicle is adjusted to normal level.

### Suspension tuning

#### General notes

The Adaptive Damping System ADS PLUS automatically controls the calibration of the dampers.

The damping is tuned individually to each wheel and depends on:

- your driving style, e.g. sporty
- the road surface condition, e.g. bumps
- your individual selection, i.e. sports or comfort

Your selection remains stored even if you remove the SmartKey from the ignition lock.

- i** You can choose between the sporty and comfortable mode. One of the two modes is always active.

## Sports tuning

The firmer setting of the suspension tuning in SPORT mode ensures the best possible contact with the road. Select this mode when employing a sporty driving style, e.g. on winding country roads.

### All vehicles except Mercedes-AMG vehicles:

- ▶ **If indicator lamp ② is not lit:** press button ①. Indicator lamp ② lights up. Sports suspension tuning is selected. The vehicle is lowered by 0.4 in (10 mm) compared to the normal level.

The **AIRMATIC SPORT** message appears in the multifunction display.

### Mercedes-AMG vehicles:

- ▶ **If indicator lamp ② is not lit:** press button ①. Indicator lamp ② lights up. If the driving speed is higher than 75 mph (120 km/h), the vehicle is automatically lowered by another 0.4 in (10 mm) compared to the normal level in sport mode.

The **AMG Suspension System SPORT** message appears in the multifunction display.

## Comfort tuning



In comfort mode, the driving characteristics of your vehicle are more comfortable. Therefore, select this mode if you favor a more comfortable driving style. Select comfort mode also when driving fast on straight roads, e.g. on straight stretches of highway.

- ▶ **If indicator lamp ② is not lit:** press button ①. Indicator lamp ② lights up. Comfort tuning is selected.

**All vehicles except Mercedes-AMG vehicles:** the **AIRMATIC COMFORT** message appears in the multifunction display.

**Mercedes-AMG vehicles:** the **AMG Suspension System COMFORT** message appears in the multifunction display.

If the driving speed is higher than 75 mph (120 km/h), the vehicle is automatically lowered in comfort mode by 0.4 in (10 mm) compared to the normal level.

## Load compensation

The vehicle can compensate differences in the vehicle level by raising or lowering the axles.

### 4MATIC (permanent four-wheel drive)

4MATIC ensures that all four wheels are permanently driven. Together with ESP®, it improves the traction of your vehicle whenever a drive wheel spins due to insufficient grip.

If you fail to adapt your driving style, 4MATIC can neither reduce the risk of accident nor override the laws of physics. 4MATIC cannot take account of road, weather and traffic conditions. 4MATIC is only an aid. You are responsible for the distance to the vehicle in front, for vehicle speed, for braking in good time and for staying in your lane.

If a drive wheel spins due to insufficient grip:

- Only depress the accelerator pedal as far as necessary when pulling away.
- Accelerate less when driving.

**!** Never tow the vehicle with one axle raised. This may damage the transfer case. Damage of this sort is not covered by the Mercedes-Benz Limited Warranty. All wheels must remain either on the ground or be fully raised. Observe the instructions for towing the vehicle with all wheels in full contact with the ground.

**i** In wintry driving conditions, the maximum effect of 4MATIC can only be achieved if you use winter tires (M+S tires), with snow chains if necessary.

## PARKTRONIC

### Important safety notes

PARKTRONIC is an electronic parking aid with ultrasonic sensors. It monitors the area around your vehicle using six sensors in the front bumper and six sensors in the rear bumper. PARKTRONIC indicates visually and audibly the distance between your vehicle and an object. PARKTRONIC is only an aid. It is not a replacement for your attention to your immediate surroundings. You are always responsible for safe maneuvering, parking and exiting a parking space. When maneuvering, parking or pulling out of a parking space, make sure that there are no persons, animals or objects in the area in which you are maneuvering.

**!** When parking, pay particular attention to objects above or below the sensors, such as flower pots or trailer drawbars. PARKTRONIC does not detect such objects when they are in the immediate vicinity of the vehicle. You could damage the vehicle or the objects.

The sensors may not detect snow and other objects that absorb ultrasonic waves.

Ultrasonic sources such as an automatic car wash, the compressed-air brakes on a truck or a pneumatic drill could cause PARKTRONIC to malfunction.

PARKTRONIC may not function correctly on uneven terrain.

PARKTRONIC is activated automatically when you:

- switch on the ignition
- shift the transmission to position **D**, **R** or **N**

PARKTRONIC is deactivated at speeds above 11 mph (18 km/h). It is reactivated at lower speeds.

### Range of the sensors

#### General notes

PARKTRONIC does not take objects into consideration that are:

- below the detection range, e.g. people, animals or objects.
- above the detection range, e.g. overhanging loads, truck overhangs or loading ramps.



① Sensors in the front bumper, left-hand side (example)

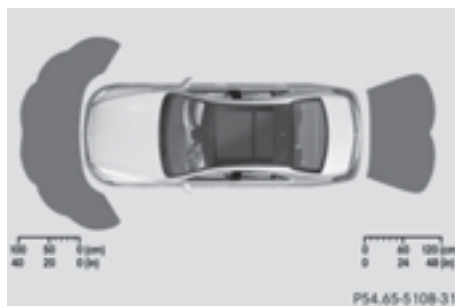
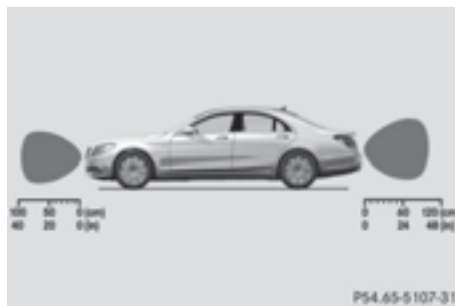

The sensors must be free from dirt, ice or slush. They can otherwise not function correctly. Clean the sensors regularly, taking care not to scratch or damage them (> page 362).

#### Front sensors

Center	Approx. 40 in (approx. 100 cm)
Corners	Approx. 24 in (approx. 60 cm)



## Rear sensors

Center	Approx. 48 in (approx. 120 cm)
Corners	Approx. 32 in (approx. 80 cm)

## Minimum distance

Center	Approx. 8 in (approx. 20 cm)
Corners	Approx. 6 in (approx. 15 cm)

If there is an obstacle within this range, the relevant warning displays light up and a warning tone sounds. If the distance falls below the minimum, the distance may no longer be shown.

## Warning displays



- ① Segments on the left-hand side of the vehicle
- ② Segments on the right-hand side of the vehicle
- ③ Segments showing operational readiness

The warning displays show the distance between the sensors and the obstacle. The warning display for the front area is in the instrument cluster. The warning display for the rear area is located on the headliner in the rear compartment.

The warning display for each side of the vehicle is divided into five yellow and two red segments. PARKTRONIC is operational if operational readiness indicator ③ lights up.

The selected transmission position and the direction in which the vehicle is rolling determine which warning display is active when the engine is running.

Transmission position	Warning display
D	Front area activated
R, N or the vehicle is rolling backwards	Rear and front areas activated
P	No areas activated

One or more segments light up as the vehicle approaches an obstacle, depending on the vehicle's distance from the obstacle.

From the:

- sixth segment onwards, you will hear an intermittent warning tone for approximately two seconds.
- seventh segment onwards, you will hear a warning tone for approximately two seconds. This indicates that you have now reached the minimum distance.

## Deactivating/activating PARKTRONIC



- ① Indicator lamp
- ② Deactivating/activating PARKTRONIC

If indicator lamp ① is on then PARKTRONIC is deactivated. Active Parking Assist is then also deactivated.

- ⓘ PARKTRONIC is automatically activated when you turn the SmartKey to position 2 in the ignition lock.

## Problems with PARKTRONIC

Problem	Possible causes/consequences and ► Solutions
Only the red segments in the PARKTRONIC warning displays are lit. You also hear a warning tone for approximately two seconds. PARKTRONIC is then deactivated and the indicator lamp on the PARKTRONIC button lights up.	<p>PARKTRONIC has malfunctioned and has switched off.</p> <p>► If problems persist, have PARKTRONIC checked at a qualified specialist workshop.</p>
Only the red segments in the PARKTRONIC warning displays are lit. PARKTRONIC is then deactivated.	<p>The PARKTRONIC sensors are dirty or there is interference.</p> <p>► Clean the PARKTRONIC sensors (▷ page 362).</p> <p>► Switch the ignition back on.</p> <p>The problem may be caused by an external source of radio or ultrasound waves.</p> <p>► See if PARKTRONIC functions in a different location.</p>

## Active Parking Assist

### General notes

Active Parking Assist is an electronic parking aid with ultrasound. It measures the road on both sides of the vehicle. A parking symbol indicates a suitable parking space. Active steering intervention and brake application can assist you during parking and when exiting a parking space. You may also use PARKTRONIC (▷ page 214).

### Important safety notes

Active Parking Assist is merely an aid. It is not a replacement for your attention to your immediate surroundings. You are always responsible for safe maneuvering, parking and exiting a parking space. Make sure that no persons, animals or objects are in the maneuvering range. When PARKTRONIC is switched off, Active Parking Assist is also unavailable.

#### WARNING

While parking or pulling out of a parking space, the vehicle swings out and can drive onto areas of the oncoming lane. This could

result in a collision with another road user. There is a risk of an accident.

Pay attention to other road users. Stop the vehicle if necessary or cancel the Active Parking Assist parking procedure.

**!** If unavoidable, you should drive over obstacles such as curbs slowly and not at a sharp angle. Otherwise, you may damage the wheels or tires.

Active Parking Assist may possibly indicate parking spaces which are not suitable for parking, for example:

- where parking or stopping is prohibited
- in front of driveways or entrances and exits
- on unsuitable surfaces

Parking tips:

- On narrow roads, drive as close to the parking space as possible.
- Parking spaces that are littered or overgrown might be identified or measured incorrectly.
- Parking spaces that are partially occupied by trailer drawbars might not be identified as such or be measured incorrectly.

- Snowfall or heavy rain may lead to a parking space being measured inaccurately.
- Pay attention to the PARKTRONIC (▷ page 215) warning messages during the parking procedure.
- You can intervene in the steering procedure to correct it at any time. Active Parking Assist will then be canceled.
- When transporting a load which protrudes from your vehicle, you should not use Active Parking Assist.
- Never use Active Parking Assist when snow chains are installed.
- Make sure that the tire pressures are always correct. This has a direct influence on the parking characteristics of the vehicle.

Use Active Parking Assist for parking spaces:

- parallel or at right angles to the direction of travel
- that are on straight roads, not bends
- that are on the same level as the road, e.g. not on the pavement

### Detecting parking spaces

Objects located above the height range of Active Parking Assist will not be detected when the parking space is measured. These are not taken into account when the parking procedure is calculated, e.g. overhanging loads, tail sections or loading ramps of goods vehicles.

#### WARNING

If there are objects above the detection range:

- Active Park Assist may steer too early
- the vehicle may not stop in front of these objects

You may cause a collision as a result. There is a risk of an accident.

If objects are located above the detection range, stop and deactivate Active Parking Assist.

For further information on the detection range (▷ page 214).

Active Parking Assist does not assist you parking in spaces at right angles to the direction of travel if:

- two parking spaces are located directly next to one another
- the parking space is directly next to a low obstacle such as a low curb
- you park forwards

Active Parking Assist does not assist you parking in spaces that are parallel or at right angles to the direction of travel if:

- the parking space is on a curb
- the system reads the parking space as being blocked, for example by foliage or grass paving blocks
- the area is too small for the vehicle to maneuver into
- the parking space is bordered by an obstacle, e.g. a tree, a post or a trailer



- ① Detected parking space on the left
- ② Parking symbol
- ③ Detected parking space on the right

Active Parking Assist is switched on automatically when driving forwards. The system is operational at speeds of up to approximately 22 mph (35 km/h). While in operation, the system independently locates and measures parking spaces on both sides of the vehicle.

Active Parking Assist will only detect parking spaces:

- parallel or at right angles to the direction of travel
- that are parallel to the direction of travel and at least 59 in (1.5 m) wide

- that are parallel to the direction of travel and at least 39.5 in (1.0 m) longer than your vehicle
- that are at right angles to the direction of travel and at least 39.5 in (1.0 m) wider than your vehicle

**i** Note that Active Parking Assist cannot measure the size of a parking space if it is at right angles to the direction of travel. You will need to judge whether your vehicle will fit into the parking space.

When driving at speeds below 19 mph (30 km/h), you will see the parking symbol as a status indicator in the instrument cluster. When a parking space has been detected, an arrow towards the right or the left also appears. By default, Active Parking Assist only displays parking spaces on the front-passenger side. Parking spaces on the driver's side are displayed as soon as the turn signal on the driver's side is activated. When parking on the driver's side, this must remain switched on until you acknowledge the use of Active Parking Assist by pressing the  button on the multifunction steering wheel. The system automatically determines whether the parking space is parallel or at right angles to the direction of travel.

A parking space is displayed while you are driving past it, and until you are approximately 50 ft (15 m) away from it.

## Parking

### WARNING

If you leave the vehicle when it is only being braked by Active Parking Assist it could roll away if:

- there is a malfunction in the system or in the voltage supply.
- the electrical system in the engine compartment, the battery or the fuses have been tampered with.
- the battery is disconnected.
- the accelerator pedal has been depressed, e.g. by a vehicle occupant.

There is a risk of an accident.

Before leaving the vehicle, always secure it against rolling away.

**i** When PARKTRONIC detects obstacles, Active Parking Assist brakes automatically during the parking process. You are responsible for braking in good time.

► Stop the vehicle when the parking space symbol shows the desired parking space in the instrument cluster.

► Shift the transmission to position **R**.

The **Start Park Assist? Yes: OK No:**  message appears in the multifunction display.

► **To cancel the procedure:** press the  button on the multifunction steering wheel or pull away.

or

► **To park using Active Parking Assist:** press the  button on the multifunction steering wheel.

The **Park Assist Active Accelerate and Brake Observe Surroundings** message appears in the multifunction display.

► Let go of the multifunction steering wheel.

► Back up the vehicle, being ready to brake at all times. When backing up, drive at a speed below approximately 6 mph (10 km/h). Otherwise Active Parking Assist will be canceled. Active Parking Assist brakes the vehicle to a standstill when the vehicle approaches the rear border of the parking space.

Maneuvering may be required in tight parking spaces.

The **Park Assist Active Select D Observe Surroundings** message appears in the multifunction display.

► Shift the transmission to position **D** while the vehicle is stationary.

Active Parking Assist immediately steers in the other direction.

The **Park Assist Active Accelerate and Brake Observe Surroundings** message appears in the multifunction display.

**i** You will achieve the best results by waiting for the steering procedure to complete before pulling away.

► Drive forwards and be ready to brake at all times.

Active Parking Assist brakes the vehicle to a standstill.

The **Park Assist Active Select R Observe Surroundings** message appears in the multifunction display.

As soon as the parking procedure is complete, the **Park Assist Switched Off** message appears and a warning tone sounds. The vehicle is now parked. The vehicle is kept stationary without the driver having to depress the brake pedal. The braking effect is canceled when you depress the accelerator pedal.

Active Parking Assist no longer supports you with steering interventions and brake applications. When Active Parking Assist is finished, you must steer and brake again yourself. PARKTRONIC is still available.

Parking tips:

- The way your vehicle is positioned in the parking space after parking is dependent on various factors. These include the position and shape of the vehicles parked in front and behind it and the conditions of the location. It may be the case that Active Parking Assist guides you too far into a parking space, or not far enough into it. In some cases, it may also lead you across or onto the curb. If necessary, you should cancel the parking procedure with Active Parking Assist.
- You can also select preselect transmission position **D**. The vehicle redirects and does not drive as far into the parking space. Should the transmission change take place too early, the parking procedure will be canceled. A sensible parking position can no longer be achieved from this position.

### Exiting a parking space



In order that Active Parking Assist can support you when you exit the parking space:

- the border of the parking space must be high enough at the front and the rear. A curb is too small, for example.
- the border of the parking space must not be too wide, as the position of the vehicle must not exceed an angle of 45° to the starting position as it is maneuvering into the parking space.
- a maneuvering distance of at least 3.3 ft (1.0 m) must be available.

Active Parking Assist can only assist you with exiting a parking space if you have parked the vehicle parallel to the direction of travel using Active Parking Assist.

- ❗ If PARKTRONIC detects obstacles, Active Parking Assist brakes automatically whilst the

vehicle exits the parking space. You are responsible for braking in good time.

- ▶ Start the engine.
- ▶ Release the electric parking brake.
- ▶ Switch on the turn signal in the direction you will drive out of the parking space.
- ▶ Shift the transmission to position **D** or **R**. The **Start Park Assist? Yes: OK No:**  message appears in the multifunction display.
- ▶ **To cancel the procedure:** press the  button on the multifunction steering wheel or pull away.

or

- ▶ **To exit a parking space using Active Parking Assist:** press the  button on the multifunction steering wheel. The **Park Assist Active Accelerate and Brake Observe Surroundings** message appears in the multifunction display.
- ▶ Let go of the multifunction steering wheel.
- ▶ Pull away, being ready to brake at all times. Do not exceed a maximum speed of approximately 6 mph (10 km/h) when exiting a parking space. Otherwise Active Parking Assist will be canceled.
- ▶ Shift the transmission to position **D** or **R** as required or according to the message while the vehicle is stationary. Active Parking Assist immediately steers in the other direction. The **Park Assist Active Accelerate and Brake Observe Surroundings** message appears in the multifunction display.

- ❗ You will achieve the best results by waiting for the steering procedure to complete before pulling away.

If you back up after activation, the steering wheel is moved to the straight-ahead position.

- ▶ Drive forwards and back up as prompted by the PARKTRONIC warning displays, several times if necessary.

Once you have exited the parking space completely, the steering wheel is moved to the straight-ahead position. You hear a tone and the **Park Assist Switched Off** message appears in the multifunction display. You will then have to steer and merge into traffic on your own. PARKTRONIC is still available. You can take over the steering, before the vehicle has exited the parking space completely. This is useful, for

example when you recognize that it is already possible to pull out of the parking space.

### Canceling Active Parking Assist

- ▶ Stop the movement of the multifunction steering wheel or steer yourself. Active Parking Assist will be canceled at once. The **Park Assist Canceled** message appears in the multifunction display.

or

- ▶ Press the PARKTRONIC button (> page 215). PARKTRONIC is switched off and Active Parking Assist is immediately canceled. The **Park Assist Canceled** message appears in the multifunction display.

Active Parking Assist is canceled automatically if:

- the electric parking brake is engaged
- transmission position **P** is selected
- parking using Active Parking Assist is no longer possible
- you are driving faster than 6 mph (10 km/h)
- a wheel spins, ESP® intervenes or fails. The  warning lamp lights up in the instrument cluster

A warning tone sounds. The parking symbol disappears and the multifunction display shows the **Park Assist Canceled** message.

When Active Parking Assist is canceled, you must steer and brake again yourself.

If a system malfunction occurs, the vehicle is braked to a standstill. To drive on, depress the accelerator again.

### Rear view camera

#### General notes



Rear view camera ① is in the trunk lid handle. Rear view camera ① is an optical parking and maneuvering aid. It shows the area behind the vehicle with guide lines in the multimedia system.

The area behind the vehicle is displayed as a mirror image, as in the rear view mirror.

- ① The text shown in the multimedia system depends on the language setting. The following are examples of rear view camera displays in the multimedia system.

### Important safety notes

The rear view camera is only an aid. It is not a replacement for your attention to your immediate surroundings. You are always responsible for safe maneuvering and parking. When maneuvering or parking, make sure that there are no persons, animals or objects in the area in which you are maneuvering.

Under the following circumstances, the rear view camera will not function, or will function in a limited manner:

- if the trunk lid is open
- in heavy rain, snow or fog
- at night or in very dark places
- if the camera is exposed to very bright light
- if the area is lit by fluorescent bulbs or LED lighting (the display may flicker)
- if the camera lens fogs up, e.g. when driving into a heated garage in winter, causing a rapid change in temperature
- if the camera lens is dirty or obstructed
- if the rear of your vehicle is damaged. In this event, have the camera position and setting checked at a qualified specialist workshop

The field of vision and other functions of the rear view camera may be restricted due to additional accessories on the rear of the vehicle (e.g. license plate holder, bicycle rack).

The guide lines on the multimedia system show the distances to your vehicle. The distances only apply to road level.

- ① The rear view camera is protected from raindrops and dust by means of a flap. When the rear view camera is activated, this flap opens.

The flap closes again when:

- you have finished the maneuvering process
- you switch off the engine
- you open the trunk

Observe the notes on cleaning (▷ page 363).

For technical reasons, the flap may remain open briefly after the rear view camera has been deactivated.

### Activating/deactivating the rear view camera

- ▶ **To activate:** make sure that the SmartKey is in position **2** in the ignition lock.
- ▶ Make sure that the **Activation by R gear** function is selected in the multimedia system (see the separate operating instructions).
- ▶ Engage reverse gear.  
The rear view camera flap opens. The multimedia system shows the area behind the vehicle with guide lines.  
The image from the rear view camera is available throughout the maneuvering process.

**To deactivate:** the rear view camera deactivates if you shift the transmission to **P** or after driving forwards a short distance.

### Displays in the multimedia system

The rear view camera may show a distorted view of obstacles, show them incorrectly or not at all. The rear view camera does not show objects in the following positions:

- very close to the rear bumper
- under the rear bumper
- in the area immediately above the handle in the trunk lid

**!** Objects not at ground level may appear to be further away than they actually are, e.g.:

- the bumper of a parked vehicle
- the drawbar of a trailer
- the ball coupling of a trailer tow hitch
- the rear section of an HGV
- a slanted post

Use the guidelines only for orientation.

Approach objects no further than the bottom-most guideline.



- ① Yellow guide line at a distance of approximately 13 ft (4.0 m) from the rear of the vehicle
- ② White guide line without turning the steering wheel, vehicle width including the exterior mirrors (static)
- ③ Yellow guide line for the vehicle width including the exterior mirrors, for current steering wheel angle (dynamic)
- ④ Yellow lane marking tires at current steering wheel angle (dynamic)



- ⑤ Yellow guide line at a distance of approximately 3 ft (1.0 m) from the rear of the vehicle
- ⑥ Vehicle center axle (marker assistance)
- ⑦ Bumper
- ⑧ Red guide line at a distance of approximately 12 in (0.30 m) from the rear of the vehicle

The guide lines are shown when the transmission is in position **R**.

The distance specifications only apply to objects that are at ground level.



- ① Front warning display
- ② Additional PARKTRONIC measurement operational readiness indicator
- ③ Rear warning display

**Vehicles with PARKTRONIC:** when PARKTRONIC is operational (▷ page 215), additional measurement operational readiness indicator ② appears in the multimedia system. If the PARKTRONIC warning displays are active or light up, warning displays ① and ③ are also active or light up correspondingly in the multimedia system.

## "Reverse parking" function

### Backing up straight into a parking space without turning the steering wheel



- ① White guide line without turning the steering wheel, vehicle width including the exterior mirrors (static)
- ② Yellow guide line for the vehicle width including the exterior mirrors, for current steering wheel angle (dynamic)
- ③ Yellow guide line at a distance of approximately 3 ft (1.0 m) from the rear of the vehicle
- ④ Red guide line at a distance of approximately 12 in (0.30 m) from the rear of the vehicle

- ▶ Make sure that the rear view camera is switched on.  
The lane and the guide lines are shown.
- ▶ With the help of white guide line ①, check whether the vehicle will fit into the parking space.
- ▶ Using white guide line ① as a guide, carefully back up until you reach the end position. Red guide line ④ is then at the end of the parking space. The vehicle is almost parallel in the parking space.

### Reverse perpendicular parking with the steering wheel at an angle



- ① Parking space marking
- ② Yellow guide line for the vehicle width including the exterior mirrors, for current steering wheel angle (dynamic)
- ▶ Drive past the parking space and bring the vehicle to a standstill.
- ▶ Make sure that the rear view camera is switched on.  
The lane and the guide lines are shown.
- ▶ While the vehicle is at a standstill, turn the steering wheel in the direction of the parking space until yellow guide line ② reaches parking space marking ①.
- ▶ Keep the steering wheel in that position and back up carefully.





- ① Yellow guide line for the vehicle width including the exterior mirrors, for current steering wheel angle (dynamic)
- ▶ Stop the vehicle when it is almost exactly in front of the parking space. The white lane should be as close to parallel with the parking space marking as possible.



- ① White guide line at current steering wheel angle
- ② Parking space marking
- ▶ Turn the steering wheel to the center position while the vehicle is stationary.



- ① Red guide line at a distance of approximately 12 in (0.30 m) from the rear of the vehicle
- ② White guide line without turning the steering wheel
- ③ End of parking space
- ▶ Back up carefully until you have reached the final position. Red guide line ① is then at end of parking space ③. The vehicle is almost parallel in the parking space.

### 180° view



- ① Symbol for the 180° view function
- ② Own vehicle
- ③ PARKTRONIC warning displays

You can also use the rear view camera to select a 180° view.

When PARKTRONIC is operational (▷ page 215), a symbol for your own vehicle appears in the multimedia system. If the PARKTRONIC warning displays are active, warning displays ② light up in the multimedia system in yellow or red accordingly.

## Object detection

The rear view camera can detect moving and stationary objects. If, for example, a pedestrian or another vehicle is detected, these objects are marked with bars. The system is only able to detect and mark stationary objects when your vehicle is moving. When the vehicle is stationary, moving objects can be detected and marked.

To ensure that you can use the function, it must be switched on in the multimedia system (see the separate operating instructions).

### 360° camera (surround view)

#### General notes

The 360° camera is a system consisting of four cameras.

The system processes images from the following cameras:

- Rear view camera
- Front camera
- Two side cameras in the exterior mirrors

The cameras capture the immediate surroundings of the vehicle. The 360° camera assists you, for instance when parking or at exits with reduced visibility.

You can show images from the 360° camera in full-screen mode or in six different split-screen views on the multimedia system. A split-screen view also includes a top view of the vehicle. This view is calculated from the data supplied by the installed cameras (virtual camera).

The six split-screen views are:

- top view and picture from the rear view camera (130° viewing angle)
- top view and image from the front camera (130° viewing angle without displaying the maximum steering wheel angle)
- top view and enlarged rear view
- top view and enlarged front view
- top view and images from the rear-facing side cameras (rear wheel view)
- top view and images from the forward-facing side cameras (front wheel view)

When the function is active and you shift the transmission from **D** or **R** to **N**, the guide lines are hidden in the multimedia system.

When you change between transmission positions **D** and **R**, you see the previously selected front or rear view.

Distances measured by PARKTRONIC will also be optically displayed:

- in split screen view as red or yellow brackets around the vehicle icon in the top view, or
- at the bottom right as red or yellow brackets around the vehicle symbol in full-screen mode

The line thickness and color of the brackets show how far the vehicle is from an object.

- yellow brackets with thin lines: PARKTRONIC is active
- yellow brackets with normal lines: an object is present in close range of the vehicle
- red line: an object is present in the immediate close range of the vehicle

#### Important safety notes

The 360° camera is only an aid and may show a distorted view of obstacles, show them incorrectly or not at all. The 360° camera is not a substitute for attentive driving.

You are always responsible for safe maneuvering and parking. When maneuvering or parking, make sure that there are no persons, animals or objects in the area in which you are maneuvering.

You are always responsible for safety, and must always pay attention to your surroundings when parking and maneuvering. This applies to the areas behind, in front of and beside the vehicle. You could otherwise endanger yourself and others.

The 360° camera will not function or will function in a limited manner:

- if the doors are open
- if the exterior mirrors are folded in
- if the trunk lid is open
- in heavy rain, snow or fog
- at night or in very dark places
- if the cameras are exposed to very bright light
- if the area is lit by fluorescent bulbs or LED lighting (the display may flicker)
- if the camera lenses fog up, e.g. when driving into a heated garage in winter, causing a rapid change in temperature

- if the camera lenses are dirty or covered. Observe the notes on cleaning (▷ page 363)
- if the vehicle components in which the cameras are installed are damaged. In this event, have the camera position and setting checked at a qualified specialist workshop

Do not use the 360° camera in this case. You can otherwise injure others or cause damage to objects or the vehicle.

The guide lines on the multimedia system show the distances to your vehicle. The distances only apply to road level.

The cameras in the front and in the rear area are each protected by a flap. These flaps are opened when the 360° camera is activated. Observe the notes on cleaning (▷ page 363). For technical reasons, the flaps may remain open briefly after the 360° camera has been deactivated.

The field of vision and other functions of the camera system may be restricted due to additional accessories on the rear of the vehicle (e.g. license plate holder, bicycle rack).

On vehicles with height-adjustable chassis, depending on technical conditions, leaving the standard height can result in:

- inaccuracies in the guide lines
- inaccuracies in the display of generated images (top view)

### Activation conditions

The 360° camera image can be displayed if:

- the multimedia system is switched on
- the **360° Camera** function is switched on



**i** If the 360° camera is activated at speeds above approximately 19 mph (30 km/h), a warning message appears.

The warning message disappears if:

- the vehicle's speed falls below approximately 19 mph (30 km/h). The 360° camera is then activated.
- the message is confirmed with the  button.

### Switching the 360° camera on and off using the button



- ▶ **To switch on:** press button . Depending on whether position **D** or **R** is engaged, the following is shown:
  - full screen display with the image from the front camera
  - full screen display with the image from the rear view camera
- ▶ **To switch off:** press button  again.

### Switching on the 360° camera and multimedia system

- ▶ Press the  button in the center console. The vehicle menu is displayed.
- ▶ To select the 360° camera: turn and press the controller. Depending on whether position **D** or **R** is engaged, the following is shown:
  - a split screen with top view and the image from the front camera or
  - a split screen with top view and the image from the rear view camera

### Activating the 360° camera using reverse gear

The 360° camera images can be automatically displayed by engaging reverse gear.

- ▶ Make sure that the SmartKey is in position **2** in the ignition lock.
- ▶ Make sure that the **Activation by R gear** function is selected in the multimedia system (see the separate operating instructions).
- ▶ **To show the 360° camera image:** engage reverse gear. The multimedia system shows the area behind the vehicle in split-screen mode. You

see the top view of the vehicle and the image from the rear view camera.

### Selecting the split-screen and full screen displays

Switching between split screen views:

- ▶ To switch to the line with the vehicle icons: slide  $\uparrow$   $\odot$  the controller.
- ▶ To select a vehicle icon: turn the controller.

Switching to full screen mode:

- ▶ **180° View** Turn and press the controller.

**i** The 180° option is only available in the following views:

- Top view with picture from the rear view camera
- Top view with picture from the front camera

### Displays in the multimedia system

#### Important safety notes

The camera system may show a distorted view of obstacles, show them incorrectly or not at all. Obstacles are not shown by the system in the following locations:

- under the front and rear bumpers
- very close to the front and rear bumpers
- in close range above the handle on the trunk lid
- very close to the exterior mirrors
- in the transitional areas between the various cameras in the virtual top view

**!** Objects not at ground level may appear to be further away than they actually are, e.g.:

- the bumper of a parked vehicle
- the drawbar of a trailer
- the ball coupling of a trailer tow hitch
- the rear section of an HGV
- a slanted post

Use the guidelines only for orientation.

Approach objects no further than the bottom-most guideline.

### Top view with picture from the rear view camera

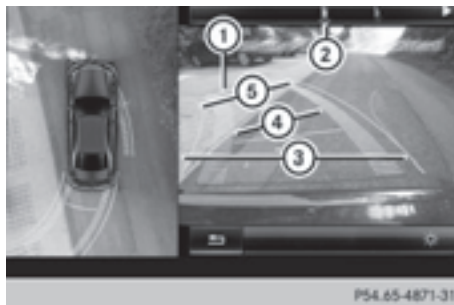

- ① Yellow guide line at a distance of approximately 13 ft (4.0 m) from the rear of the vehicle
- ② Symbol for the split screen setting with top view and rear view camera image
- ③ Guide line for the maximum steering angle
- ④ Yellow lane marking tires at current steering wheel angle (dynamic)
- ⑤ Yellow guide line for the vehicle width including the exterior mirrors, for current steering wheel angle (dynamic)



- ⑥ Vehicle center axle (marker assistance)
- ⑦ Yellow guide line at a distance of approximately 3 ft (1.0 m) from the rear of the vehicle
- ⑧ Bumper
- ⑨ Red guide line at a distance of approximately 12 in (0.30 m) from the rear of the vehicle

The guide lines are shown when the transmission is in position **R**.

The distance specifications only apply to objects that are at ground level.

### Top view with picture from the front camera



- ① Symbol for the split screen setting with top view and front camera image
- ② Yellow guide line at a distance of approximately 13 ft (4.0 m) from the front of the vehicle
- ③ Yellow guide line for the vehicle width including the exterior mirrors, for current steering wheel angle (dynamic)
- ④ Yellow lane marking tires at current steering wheel angle (dynamic)
- ⑤ Red guide line at a distance of approximately 12 in (0.30 m) from the front of the vehicle
- ⑥ Yellow guide line at a distance of approximately 3 ft (1.0 m) from the front of the vehicle

### top view and enlarged rear view



- ① Symbol for the split screen setting with top view and rear view camera image enlarged
- ② Red guide line at a distance of approximately 12 in (0.30 m) from the rear of the vehicle

This view assists you in estimating the distance to the vehicle behind you.

- i** This setting can also be selected as an enlarged front view.

### Top view with image from the side cameras

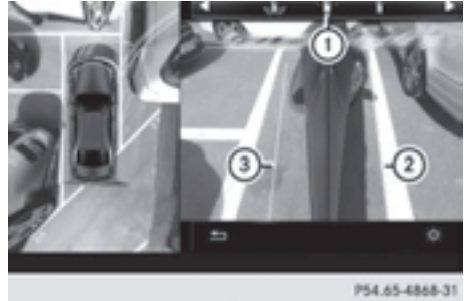

- ① Symbol for the top view and forward-facing side camera setting
  - ② Yellow guide line for the vehicle width including the exterior mirrors (right side of vehicle)
  - ③ Yellow guide line for the vehicle width including the exterior mirrors (left side of vehicle)
- i** You can also select the side camera setting for the rear-facing view.

### 180° view



- ① Symbol for the full screen setting with rear view camera image
  - ② Own vehicle
  - ③ PARKTRONIC warning displays
- i** 180° view can also be selected as front view.

Select this view when you are driving out of an exit and the view of crossing traffic is restricted, for example.

## Exiting 360° camera display mode

The 360° camera display is stopped

- when you select transmission position **P**, or
- when you are driving at moderate speeds

The view which was active before the 360° camera was displayed appears in the multimedia system. You can also stop the 360° camera display split-screen view by selecting the  symbol in the display and then confirming with the COMAND controller.

## ATTENTION ASSIST

### General notes

ATTENTION ASSIST helps you during long, monotonous journeys, such as on highways. It is active in the 37 mph (60 km/h) to 125 mph (200 km/h) range. If ATTENTION ASSIST detects typical indicators of fatigue or increasing lapses in concentration on the part of the driver, it suggests taking a break.

### Important safety notes

ATTENTION ASSIST is only an aid to the driver. It might not always recognize fatigue or increasing inattentiveness in time or fail to recognize them at all. The system is not a substitute for a well-rested and attentive driver.

The functionality of ATTENTION ASSIST is restricted and warnings may be delayed or not occur at all:

- if the length of the journey is less than approximately 30 minutes
- if the road condition is poor, e.g. if the surface is uneven or if there are potholes
- if there is a strong side wind
- if you have adopted a sporty driving style with high cornering speeds or high rates of acceleration
- if you are predominantly driving slower than 37 mph (60 km/h) or faster than 125 mph (200 km/h)
- if you are driving with the active Steer Assist of DISTRONIC PLUS
- if the time has been set incorrectly
- in active driving situations, such as when you change lanes or change your speed

The ATTENTION ASSIST tiredness assessment is deleted and restarted when continuing the journey, if:

- you switch off the engine
- you take off your seat belt and open the driver's door, e.g. for a change of drivers or to take a break

## Displaying the attention level



You can have current status information displayed in the assistance menu (▷ page 269) of the on-board computer.

- ▶ Select the Assistance display for ATTENTION ASSIST using the on-board computer (▷ page 268).

The following information is displayed:

- length of the journey since the last break.
- the attention level determined by ATTENTION ASSIST (**Attention Level**), displayed in a bar display in five levels from high to low
- if ATTENTION ASSIST is unable to calculate the attention level and cannot issue a warning, the **System Suspended** message appears. The bar display then changes the display, e.g. if you are driving at a speed below 37 mph (60 km/h) or above 124 mph (200 km/h).

## Activating ATTENTION ASSIST

- ▶ Activate ATTENTION ASSIST using the on-board computer (▷ page 271).  
The system determines the attention level of the driver depending on the setting selected:

If **Standard** is selected: the sensitivity with which the system determines the attention level is set to normal.

If **Sensitive** is selected: the sensitivity is set higher. The attention level detected by Attention

Assist is adapted accordingly and the driver is warned earlier.

When ATTENTION ASSIST is deactivated, the  symbol appears in the multifunction display in the assistance graphic display.

When ATTENTION ASSIST has been deactivated, it is automatically reactivated after the engine has been stopped. The sensitivity selected corresponds to the last selection activated (standard/sensitive).

### Warning in the multifunction display

If fatigue or increasing lapses in concentration are detected, a warning appears in the multifunction display: **ATTENTION ASSIST Take a Break!**

In addition to the message shown in the multifunction display, you will then hear a warning tone.

- ▶ If necessary, take a break.
- ▶ Confirm the message by pressing the  button on the steering wheel.

On long journeys, take regular breaks in good time to allow yourself to rest properly. If you do not take a break and ATTENTION ASSIST continues to detect increasing lapses in concentration, you will be warned again after 15 minutes at the earliest. This will only happen if ATTENTION ASSIST still detects typical indicators of fatigue or increasing lapses in concentration.

If a warning is given in the multifunction display, the multimedia system offers a service station search. You can select a service station and navigation to this service station will then begin. This function can be activated and deactivated in the multimedia system.

## Traffic Sign Assist

### General notes

Traffic Sign Assist displays the maximum speed permitted to the driver in the instrument cluster. The data and general traffic regulations stored in the navigation system are used to determine the current speed limit.

Traffic Sign Assist is a map-based system, and for this reason, traffic signs put up temporarily (e.g. near roadworks) are not detected.

If a traffic sign that is relevant to your vehicle is passed, the display of the speed limits is updated.

Traffic signs with a restriction indicated by an additional sign (e.g. in wet conditions) are also shown.

The traffic signs are only displayed with the restrictions if:

- the regulation must be observed with the restriction, or
- Traffic Sign Assist is unable to determine whether the restriction applies

If Traffic Sign Assist is unable to determine a maximum permitted speed from any of the available sources, no speed limit is displayed in the instrument cluster either.



Traffic Sign Assist is not available in all countries. In this case, symbol  is shown in the assistance graphic display (▷ page 268).

### Important safety notes

Traffic Sign Assist is only an aid and is not always able to correctly display speed limits. Traffic signs always have priority over the Traffic Sign Assist display.

The system may be either functionally impaired or temporarily unavailable if the information in the digital street map of the navigation system is incorrect or out of date.

### Activating Traffic Sign Assist

- ▶ Activate the Traffic Sign Assist display using the on-board computer (▷ page 270).

If you have activated the Traffic Sign Assist display in the on-board computer, the traffic regulations (speed limits and overtaking restrictions) are displayed in the instrument cluster for five seconds respectively. The wrong-way warning

and the traffic sign display for speed limits and overtaking restrictions remain active even when the display has been deactivated.

### Instrument cluster display

#### Displaying the assistance graphic

- ▶ Call up the assistance graphics display function using the on-board computer (> page 268).
- ▶ Select the Traffic Sign Assist display. Detected traffic signs are displayed in the instrument cluster.

#### Speed limit with unknown restriction



- ① Maximum permitted speed
- ② Maximum permitted speed for vehicles for which the restriction in the additional sign is relevant
- ③ Additional sign for unknown restriction

A maximum permitted speed of 80 mph (80 km/h) and a speed limit of 60 km/h (60 mph) with an unknown restriction apply.

#### Speed limits in wet conditions



- ① Maximum permitted speed
- ② Additional signs for wet conditions

A maximum permitted speed of 80 mph (80 km/h) applies in wet conditions and if Traffic Sign Assist has determined that the restriction must be observed.

#### Canceling the speed limit



The speed limit no longer applies ①.

- ① The unit for the speed limit (km/h or mph) depends on the country in which you are driving. It is generally neither shown on the traffic sign nor on the instrument cluster but must be taken into account when observing the maximum permitted speed.

### Night View Assist Plus

#### General notes



In addition to the illumination provided by the normal headlamps, Night View Assist Plus uses infrared light to illuminate the road. Night View Assist Plus camera ② picks up the infrared light and displays a monochrome image in the multi-function display. The image shown in the display corresponds to a road lit up by high-beam headlamps. This enables you to see the road's course and any obstacles in good time. When pedestrian recognition is active, pedestrians recog-



nized by the system are visually highlighted in color in the Night View Assist Plus display with small frame corners.

In addition, an infrared camera is integrated into the radiator trim ①. The camera helps detect pedestrians and animals. Observe the notes on cleaning the infrared camera (▷ page 364).

- ① Infrared light is not visible to the human eye and therefore does not glare. Night View Assist Plus can therefore remain switched on even if there is oncoming traffic.

### Important safety notes

Night View Assist Plus is only an aid and is not a substitute for attentive driving. Do not rely on the Night View Assist Plus display. You are responsible for the distance to the vehicle in front, for vehicle speed and for braking in good time. Drive carefully and always adapt your driving style to suit the prevailing road and traffic conditions.

The system may be impaired or may not function if:

- there is poor visibility, e.g. due to snow, rain, fog or spray
- the windshield is dirty, fogged up or covered, for instance by a sticker, in the vicinity of the camera
- the infrared camera in the radiator trim is dirty, fogged up or obscured
- on bends, hilltops or downhill gradients
- at high outside temperatures

Night View Assist Plus cannot display objects directly in front of or beside the vehicle.

It is possible that, in addition to people and animals, other objects are also marked or highlighted.

### Pedestrian and animal recognition

#### General notes

Pedestrian or animal recognition may be impaired or inoperative if:

- pedestrians or animals are partially or entirely obscured by other objects, e.g. parked vehicles
- the silhouette of the pedestrian or of the animal in the Night View Assist Plus display is incomplete or interrupted, e.g. by powerful light reflections

- pedestrians or animals do not contrast with the surroundings
- the camera system no longer recognizes pedestrians as persons due to special clothing or other objects
- pedestrians are not in an upright position, e.g. sitting, squatting or lying
- animals are not recognized by the system, e.g. because of their size or shape

Pedestrian and animal recognition is deactivated at temperatures above 90 °F (32 °C). The spotlight function and automatic delayed switch-off are then no longer active.

#### Pedestrian recognition



- ① Night View Assist Plus display
- ② Readiness symbol for active pedestrian recognition
- ③ Highlighting
- ④ Pedestrian recognized

Night View Assist Plus can recognize pedestrians using typical characteristics, e.g. the body contours and posture of a person standing upright.

Pedestrian recognition is then switched on automatically if:

- Night View Assist Plus is activated.
- you are driving faster than approximately 6 mph (10 km/h).
- it is dark.

If pedestrian recognition is active, readiness symbol ② appears. Persons who are detected are highlighted by framing ③. If the pedestrian recognition system has brought a pedestrian to your attention, look through the windshield to evaluate the situation. The actual distance to objects and pedestrians cannot be gaged accurately by looking at a screen.

## Animal recognition

Animals can be recognized in the following situations:

- darkness
- outside built-up areas
- below an ambient temperature of 90 °F (32 °C).

Night View Assist Plus can recognize larger animals such as deer, cows or horses using typical characteristics.

The system does not detect:

- smaller animals, e.g. dogs and cats
- animals whose silhouette is not clearly recognizable

When detected, animals are marked with small color frame corners. In contrast to pedestrian recognition, there is no separate readiness symbol in the multifunction display.

## Activating/deactivating Night View Assist Plus

### Activation conditions

You can only activate Night View Assist Plus if all of the following conditions are met:

- the ignition is switched on (> page 162) or the engine has been started.
- the light switch is in the **AUTO** or  position.
- reverse gear has not been engaged.

### Activating Night View Assist Plus



- ▶ Press button ①.

The Night View Assist Plus display appears in the multifunction display.

- ❗ The infrared headlamps only switch on in the dark from speeds of approximately 6 mph (10 km/h). This means that you do not have

the full visual range while the vehicle is stationary and cannot check whether Night View Assist Plus is working. The infrared headlamps are deactivated at speeds below 3 mph (5 km/h). The Night View image continues to be displayed until you deactivate it by pressing button ①.

### Automatic activation

You can select the **Night View Assist Automatic Activation** option via the Night View Assist menu. The pedestrian and animal search function remains active even when the Night View image is not displayed. In the dark, in unlit surroundings and at speeds of more than 60 km/h, the Night View image is automatically displayed in the multifunction display as soon as pedestrians or animals are detected.

- ▶ In the assistance menu, select automatic activation of Night View Assist Plus (> page 270).

### Deactivating Night View Assist Plus

- ▶ Press button ①.

The Night View Assist Plus display disappears from the multifunction display. Night View Assist is deactivated.

## Spotlight function

### General notes

Under certain conditions, the spotlight function uses the headlamps to flash at detected pedestrians.

The spotlight function is only active if:

- pedestrian recognition is active
- the road surface is not lit
- the driving speed is at least 40 mph (60 km/h)
- the "Adaptive Highbeam Assist PLUS" function is activated (> page 133)

The spotlight function is not active or is active only to a limited extent if:

- you are driving in city traffic
- there are pedestrians located in the area of an oncoming vehicle or a vehicle in front

### Activating the spotlight function

The pedestrian detection with spotlight function is running the background. If the prerequisites are met, the spotlight function uses the head-

lamps to flash four short pulses at a pedestrian detected on or near to the road surface.

- In the light menu, select the spotlight function of Night View Assist Plus (▷ page 274).

The spotlight function does not flash at animals.

### Display in the assistance graphic



Pedestrian symbol ① in the assistance graphic indicates the status of the spotlight function. If the symbol is displayed not filled in, the function is switched on. If the symbol is displayed filled in, the conditions for the spotlight function are met.

Displaying the assistance graphic

- Select the **Assistance Graphic** menu using the on-board computer (▷ page 268).

## Problems with Night View Assist Plus

Problem	Possible causes/consequences and ► Solutions
The picture quality of Night View Assist Plus has deteriorated.	The windshield is fogged up on the inside. ► Fold down camera cover (▷ page 364). ► Defrost the windshield (▷ page 151).
	The windshield is iced up. ► De-ice the windshield (▷ page 151).
	The windshield wipers are smearing the windshield. ► Replace the wiper blades (▷ page 136).
	The windshield is smeared after the vehicle has been cleaned in a car wash. ► Clean the windshield (▷ page 362).
	There is windshield chip damage in the camera's field of vision. ► Replace the windshield.
The pedestrian and animal recognition is not available.	the infrared camera in the radiator trim is dirty ► Use a soft cloth and water to clean the infrared camera.

### Driving Assistance PLUS package

#### General notes

The Driving Assistance PLUS package consists of DISTRONIC PLUS (▷ page 199), Active Blind Spot Assist (▷ page 234) and Active Lane Keeping Assist (▷ page 237).

#### Active Blind Spot Assist

##### General notes

Active Blind Spot Assist uses a radar sensor system, pointed toward the rear of the vehicle, to monitor the area to the sides of the vehicle which the driver is unable to see. A warning display in the exterior mirrors draws your attention to vehicles detected in the monitored area. If you then switch on the corresponding turn signal to change lane, you will also receive an optical and audible warning. If a risk of lateral collision is detected, corrective braking may help you avoid a collision. Before a course-correcting brake application, Active Blind Spot Assist evaluates the space in the direction of travel and at the sides of the vehicle. For this, Active Blind

Spot Assist uses the forward-facing radar sensors.

Active Blind Spot Assist supports you from a speed of approximately 20 mph (30 km/h).

#### Important safety notes

Active Blind Spot Assist is only an aid and is not a substitute for attentive driving.

#### WARNING

Active Blind Spot Assist does not react to:

- vehicles overtaken too closely on the side, placing them in the blind spot area
- vehicles which approach with a large speed differential and overtake your vehicle

As a result, Active Blind Spot Assist may neither give warnings nor intervene in such situations. There is a risk of an accident.

Always observe the traffic conditions carefully, and maintain a safe lateral distance.

**i** USA only: This device has been approved by the FCC as a "Vehicular Radar System". The radar sensor is intended for use in an automotive radar system only. Removal, tamper-

ing, or altering of the device will void any warranties, and is not permitted by the FCC. Do not tamper with, alter, or use in any non-approved way.

Any unauthorized modification to this device could void the user's authority to operate the equipment.

**i** Canada only: This device complies with RSS-210 of Industry Canada. Operation is subject to the following two conditions:

1. This device may not cause harmful interference, and

2. This device must accept any interference received, including interference that may cause undesired operation of the device.

Removal, tampering, or altering of the device will void any warranties, and is not permitted. Do not tamper with, alter, or use in any non-approved way.

Any unauthorized modification to this device could void the user's authority to operate the equipment.

### Radar sensors

The Active Blind Spot Assist radar sensors are integrated into the front and rear bumpers and behind a cover in the radiator trim. Make sure that the bumpers and the cover in the radiator grill are free of dirt, ice or slush. The rear sensors must not be covered, for example by cycle racks or overhanging cargo. Following a severe impact or in the event of damage to the bumpers, have the function of the radar sensors checked at a qualified specialist workshop. Active Blind Spot Assist may otherwise no longer work properly.

### Monitoring area

#### WARNING

Active Blind Spot Assist does not detect all traffic situations and road users. There is a risk of an accident.

Always make sure that there is sufficient distance on the side for other traffic or obstacles.

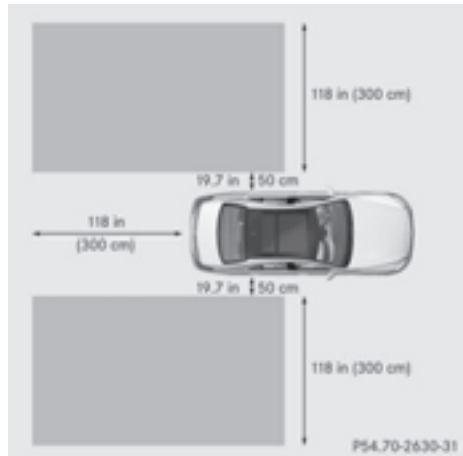

Active Blind Spot Assist monitors the area up to 10 ft (3.0 m) behind your vehicle and directly next to your vehicle, as shown in the diagram.

The detection of obstacles can be impaired in the case of:

- there is dirt on the sensors or anything else covering the sensors
  - poor visibility, e.g. due to rain, snow or spray
- Vehicles in the monitoring range are then not indicated.

Active Blind Spot Assist may not detect narrow vehicles, such as motorcycles or bicycles, or may only detect them too late.

If the lanes are narrow, vehicles driving in the lane beyond the lane next to your vehicle may be indicated, especially if the vehicles are not driving in the middle of their lane. This may be the case if there are vehicles at the inner edge of your lane.

Due to the nature of the system:

- warnings may be issued in error when driving close to crash barriers or similar solid lane borders.
- warnings may be interrupted when driving alongside particularly long vehicles, e.g. trucks, for a prolonged time.

## Warning display

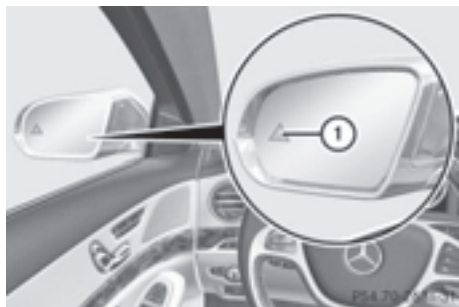

### ① Warning display

Active Blind Spot Assist is not operational at speeds below approximately 20 mph (30 km/h). Vehicles in the monitoring range are then not indicated.

If a vehicle is detected within the blind spot monitoring range at speeds above 20 mph (30 km/h), warning lamp ① on the corresponding side lights up red. This warning is always emitted when a vehicle enters the blind spot monitoring range from behind or from the side. When you overtake a vehicle, the warning only occurs if the difference in speed is less than 7 mph (12 km/h).

If you select the reverse gear, Active Blind Spot Assist is not operational.

The brightness of the warning lamps is automatically adapted to the brightness of the surroundings.



When Active Blind Spot Assist is activated, gray radar waves propagating backwards appear next to the vehicle in the assistance display in the multifunction display. Above a speed of 20 mph (30 km/h), the color of the radar waves in the assistance display changes to green ②. Active Blind Spot Assist is then ready for use.

## Visual and acoustic collision warning

If you switch on the turn signals to change lanes and a vehicle is detected in the side monitoring range, you receive a visual and acoustic collision warning. You will then hear a double warning

tone and red warning lamp ① flashes. If the turn signal remains on, detected vehicles are indicated by the flashing of red warning lamp ①. There are no further warning tones.

## Course-correcting brake application

If Active Blind Spot Assist detects a risk of a lateral collision in the monitoring range, a course-correcting brake application is carried out. This is meant to assist you in avoiding a collision.

### ⚠ WARNING

A course-correcting brake application cannot always prevent a collision. There is a risk of an accident.

Always steer, brake or accelerate yourself, especially if Active Blind Spot Assist warns you or makes a course-correcting brake application. Always maintain a safe distance at the sides.



If a course-correcting brake application occurs, red warning lamp ① flashes in the exterior mirror and a dual warning tone sounds. In addition, display ② underlining the danger of a side collision appears in the multifunction display.

In very rare cases, the system may make an inappropriate brake application. A course-correcting brake application may be interrupted at any time by countersteering slightly or accelerating.

The course-correcting brake application is available in the speed range between 20 mph (30 km/h) and 120 mph (200 km/h).

Either no braking application, or a course-correcting brake application adapted to the driving situation occurs if:

- there are vehicles or obstacles, e.g. crash barriers, located on both sides of your vehicle.
- a vehicle approaches you too closely at the side.
- you have adopted a sporty driving style with high cornering speeds.
- you clearly brake or accelerate.
- a driving safety system intervenes, e.g. ESP® or PRE-SAFE® Brake.
- ESP® is switched off.
- a loss of tire pressure or a defective tire is detected.

### Switching on Active Blind Spot Assist

- ▶ Make sure that Active Blind Spot Assist is activated in the on-board computer (> page 271).
- ▶ Turn the SmartKey to position **2** in the ignition lock.  
Warning lamps ① in the exterior mirrors light up red for approximately 1.5 seconds. Gray radar waves propagating backwards appear next to the vehicle in the assistance display in the multifunction display.

## Active Lane Keeping Assist

### General notes



Active Lane Keeping Assist monitors the area in front of your vehicle by means of multifunction camera ① at the top of the windshield. Various different areas to the front, rear and side of your vehicle are also monitored with the aid of the radar sensor system. Active Lane Keeping Assist detects lane markings on the road and can warn you before you leave your lane unin-

tionally. If you do not react to the warning, a lane-correcting application of the brakes can bring the vehicle back into the original lane.

This function is available in a speed range between 40 mph and 120 mph (60 km/h and 200 km/h).

### Important safety notes

If you fail to adapt your driving style, Active Lane Keeping Assist can neither reduce the risk of accident nor override the laws of physics. Active Lane Keeping Assist cannot take account of road and weather conditions. It may not recognize traffic situations. Active Lane Keeping Assist is only an aid. You are responsible for the distance to the vehicle in front, for vehicle speed, for braking in good time and for staying in your lane.

Active Lane Keeping Assist cannot continuously keep your vehicle in its lane.

### ⚠ WARNING

Active Lane Keeping Assist cannot always clearly detect lane markings.

In such cases, Active Lane Keeping Assist can:

- give an unnecessary warning and then make a course-correcting brake application to the vehicle
- not give a warning or intervene

There is a risk of an accident.

Always pay particular attention to the traffic situation and keep within the lane, especially if Active Lane Keeping Assist alerts you. Terminate the intervention in a non-critical driving situation.

The system may be impaired or may not function if:

- there is poor visibility, e.g. due to insufficient illumination of the road, or due to snow, rain, fog or spray
- there is glare, e.g. from oncoming traffic, the sun or reflections (e.g. when the road surface is wet)
- the windshield is dirty, fogged up, damaged or covered, for instance by a sticker, in the vicinity of the camera

- the radar sensors in the front or rear bumpers or the radiator trim are dirty, e.g. obscured by snow
  - there are no, several or unclear lane markings for a lane, e.g. in areas with road construction work
  - the lane markings are worn away, dark or covered up, e.g. by dirt or snow
  - the distance to the vehicle in front is too small and the lane markings thus cannot be detected
  - the lane markings change quickly, e.g. lanes branch off, cross one another or merge
  - the road is narrow and winding
  - there are strong shadows cast on the road
- If no vehicle is detected in the adjacent lane and broken lane markings are detected, no lane-correcting brake application is made.

### Warning vibration in the steering wheel

A warning may be given if a front wheel passes over a lane marking. It will warn you by means of intermittent vibration in the steering wheel for up to 1.5 seconds.

In order that you are warned only when necessary and in good time if you cross the lane marking, the system recognizes certain conditions and warns you accordingly.

The warning vibration occurs earlier if:

- you approach the outer lane marking on a bend.
- the road has very wide lanes, e.g. a highway.
- the system recognizes solid lane markings.

The warning vibration occurs later if:

- the road has narrow lanes
- you cut the corner on a bend

### Lane-correcting brake application

If you leave your lane, under certain circumstances the vehicle will brake briefly on one side. This is meant to assist you in bringing the vehicle back to the original lane.

#### WARNING

A lane-correcting brake application cannot always bring the vehicle back into the original lane. There is a risk of an accident.

Always steer, brake or accelerate yourself, especially if Active Lane Keeping Assist warns

you or makes a lane-correcting brake application.

#### WARNING

Active Lane Keeping Assist does not detect traffic conditions or road users. In very rare cases, the system may make an inappropriate brake application, e.g. after intentionally driving over a solid lane marking. There is a risk of an accident.

An inappropriate brake application may be interrupted at any time if you steer slightly in the opposite direction. Always make sure that there is sufficient distance on the side for other traffic or obstacles.



If a lane-correcting brake application occurs, display ① appears in the multifunction display. The brake application also slightly reduces vehicle speed.

A lane-correcting brake application can be made after driving over a lane marking recognized as being solid or broken. Before this, a warning must be given by means of intermittent vibration in the steering wheel. In addition, a lane with lane markings on both sides must be recognized.

In the case of a broken lane marking being detected, a lane-correcting brake application can only be made if a vehicle has been detected in the adjacent lane. The following vehicles can have an influence on brake application: oncoming traffic, vehicles that are overtaking and vehicles that are driving parallel to your vehicle.

- i** A further lane-correcting brake application can only occur after your vehicle has returned to the original lane.



No lane-correcting brake application occurs if:

- you clearly and actively steer, brake or accelerate.
- you cut the corner on a sharp bend.
- you have switched on the turn signal.
- a driving safety system intervenes, e.g. ESP®, PRE-SAFE® Brake or Active Blind Spot Assist.
- you have adopted a sporty driving style with high cornering speeds or high rates of acceleration.
- ESP® is switched off.
- the transmission is not in position D.
- a loss of tire pressure or a defective tire has been detected and displayed.
- an obstacle in the lane in which you are driving has been detected.

Active Lane Keeping Assist may not detect other road users or traffic situations. An inappropriate brake application may be interrupted at any time if you:

- steer slightly in the opposite direction
- switch on the turn signal
- clearly brake or accelerate

A lane-correcting brake application is interrupted automatically if:

- a driving safety system intervenes, e.g. ESP®, PRE-SAFE® Brake or Active Blind Spot Assist.
- lane markings can no longer be recognized.

### Switching on Active Lane Keeping Assist



- ▶ Press button ②.

Indicator lamp ① lights up. The **Lane Keeping Assist On** message appears in the multifunction display. If all conditions have been satisfied, a warning or steering intervention may be made.

If you drive at speeds above 40 mph (60 km/h) and lane markings are detected,

the lines in the assistance graphics display (▷ page 268) are shown in green. Active Lane Keeping Assist is ready for use.

- ▶ **To switch off:** press button ②.

Indicator lamp ① goes out. The Active Lane Keeping Assist is deactivated. The **Lane Keeping Assist Off** message appears in the multifunction display.

### Selecting Standard or Adaptive setting

- ▶ In the **DriveAssist** menu on the on-board computer, select the **Active Lane Keeping Assist** function (▷ page 271).

- ▶ Select **Standard** or **Adaptive**.

When **Standard** is selected, no warning vibration occurs if:

- you switch on the turn signals. In this event, the warnings are suppressed for a certain period of time.
- a driving safety system intervenes, such as ABS, BAS or ESP®.

When **Adaptive** is selected, no warning vibration occurs if:

- you switch on the turn signals. In this event, the warnings are suppressed for a certain period of time.
- a driving safety system intervenes, e.g. ABS, BAS or ESP®.
- you accelerate hard, e.g. kickdown.
- you brake hard.
- you steer actively, e.g. swerve to avoid an obstacle or change lanes quickly.
- you cut the corner on a sharp bend.

In order that you are warned only when necessary and in good time if you cross the lane marking, the system recognizes certain conditions and warns you accordingly.

The warning vibration occurs earlier if:

- you approach the outer lane marking on a bend.
- the road has very wide lanes, e.g. a highway.
- the system recognizes solid lane markings.

The warning vibration occurs later if:

- the road has narrow lanes
- you cut the corner on a bend

## PLUG-IN HYBRID operation

### Points to remember

#### General notes

Hybrid technology combines a fuel efficient internal combustion engine with a powerful electric motor. In **HYBRID** mode, the hybrid drive system automatically selects the most efficient operating mode for every driving situation. Drive the vehicle in the usual manner.

To save fuel in **HYBRID** mode, the hybrid drive system switches off the combustion engine as often as possible during the journey when power output requirements are low. When power output requirements are low, the electric motor powers the vehicle. The combustion engine is automatically activated when power output requirements are high. The engine is usually switched off when the vehicle is stationary. Consequently, there is usually no engine idling as with combustion engine vehicles.

For pulling away and accelerating, the electric motor supports the internal combustion engine using the power stored in the high-voltage battery. In addition, the power is used for partially electric driving, operation of the electric coolant compressor and to support the 12 V on-board electrical system. In this way the hybrid drive system helps to reduce your vehicle's fuel consumption.

Observe the driving tips on PLUG-IN HYBRID operation (▷ page 251).

#### Regenerative Brake System

If you release the accelerator pedal when the vehicle is in motion, overrun recuperation is initiated. The electric motor is operated as a generator when in overrun mode and when you brake. Hybrid technology converts the kinetic energy of the vehicle into electricity and stores it in the high-voltage battery.

Observe the important safety notes for the Regenerative Brake System (▷ page 44).

### Important safety notes

If the engine is switched off by the ECO start/stop function and you open the driver's door:

- a message appears in the multifunction display and
- a warning tone sounds

Further information (▷ page 297).

All of the vehicle's systems remain active, if:

- the vehicle is stationary
- the combustion engine is switched off and
- the READY indicator in the instrument cluster lights up

If you remove your foot from the brake pedal while in transmission position D or R, the vehicle may pull away automatically.

Observe the notes on the READY display of the ECO start/stop function (▷ page 252).

Vehicles with an electric motor generate much less driving noise than vehicles with internal combustion engines. As a result, your vehicle may not be heard by other road users in certain situations.

Depending on the vehicle's equipment and country-specific regulations, the vehicle can be equipped with Acoustic Vehicle Indication.

Acoustic Vehicle Indication generates a certain sound at a speed between 0 and 19 mph (30 km/h). This helps other road users, particularly pedestrians and cyclists, to hear your vehicle better. The sound can also be heard inside the vehicle.

The volume depends on the engine speed. The faster you accelerate, the louder the sound is. At a speed of over 19 mph (30 km/h) the sound is switched off. Above this speed, the natural sounds from the vehicle are sufficient that it can be heard in good time by other road users.

## Hybrid system overview

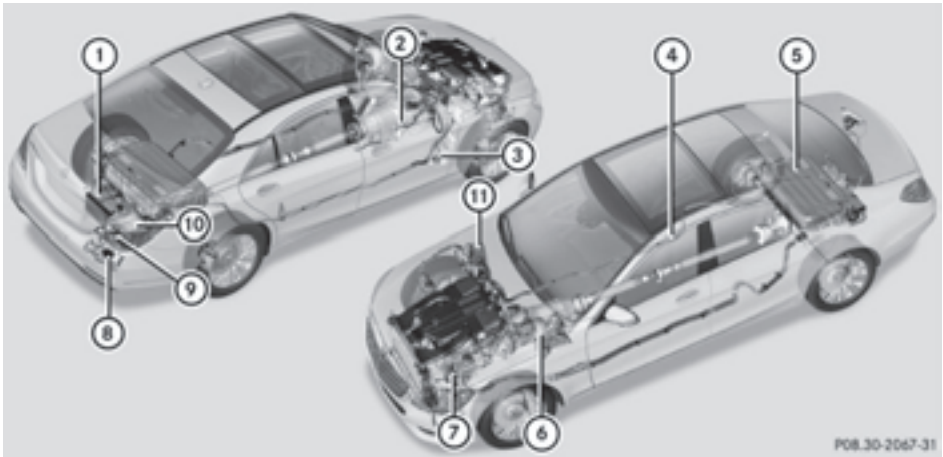

- ① 12 V battery
- ② Transmission with electric motor
- ③ Electric heater
- ④ High-voltage electrical system cables
- ⑤ High-voltage battery
- ⑥ Recuperative Brake System
- ⑦ Electric refrigerant compressor
- ⑧ Vehicle socket
- ⑨ Charger
- ⑩ Voltage transformer
- ⑪ Power electronics

You can switch off the hybrid drive system manually. For further information on the high-voltage switch-off device, see (▷ page 42).

## Instrument cluster



- ① Recuperative Brake System warning lamp (▷ page 315)
- ② Electric motor performance display (▷ page 242)
- ③ Condition of charge display for high-voltage battery (▷ page 245)
- ④ Driving mode display (▷ page 243)
- ⑤ Electrical range

## Displays and operation

## Electric motor performance display



The power display for the electric motor is located on the right-hand side of the instrument cluster.

The current condition of charge of the high-voltage battery is shown as a percentage in condition of charge display ⑤. 100% corresponds to the highest possible charge level of the high-voltage battery.

There are two further areas located to the left and right of condition of charge display ⑤:

- Area ① to ② (E-DRIVE):

This shows the electric output from the electric motor, e.g. during electric operation or in boost mode.

When the motor is switched on, the display is at lower limit ②. With increasing pressure on the accelerator pedal the display fills up from ② to ①.

**Driving with the electric motor:** when the display reaches upper limit ①, the combustion engine is switched on. If the display is approaching upper limit ① and you remove your foot from the accelerator pedal, the display empties again. The combustion engine is not switched on. At low speeds, you can thereby control the electric operation usage so that you only drive in electric mode.

**Driving with the combustion engine:** the electric motor supports the combustion engine by providing additional torque (boost mode) until the display reaches upper limit ①.

You can also select the operating mode of the hybrid drive system (> page 243).

- Area ③ to ④ (CHARGE):

This shows the recuperated energy which is stored in the high-voltage battery as electrical energy.

When the display reaches lower limit ④, the maximum recuperative braking power has been exhausted. The mechanical brake is activated.

### Selecting the operating mode



Button ① allows you to choose between different operating modes.

- ▶ Press button ① to change the operating mode.

The operating mode selected appears in the instrument cluster (> page 242).

If it is not possible to change operating modes, the display message **Change the current drive program before changing the operating mode.** or **Exit manual drive program M before changing the operating mode.** appears in the multi-function display. Further information on "Display messages" (> page 297).

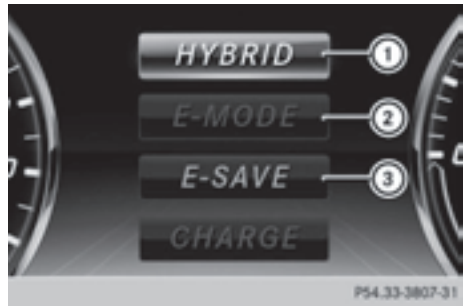

- ① Operating mode selected
- ② Operating mode unavailable
- ③ Operating mode available

<p><b>HYBRID</b></p>	<ul style="list-style-type: none"> <li>• Electric mode or driving with the internal combustion engine is possible</li> <li>• Automatic selection of drive mode with electric mode as often as possible</li> <li>• The high-voltage battery is discharged to approximately 20%</li> <li>• To subsequently maintain the condition of charge of the high-voltage battery, the electric output is reduced. All vehicle functions such as electric mode, energy recuperation or boost mode, for example, are still available.</li> </ul>
<p><b>E-MODE</b></p>	<ul style="list-style-type: none"> <li>• Electric-only operation mode up to the output limit of the electric motor</li> <li>• Electrical power output allotted using the haptic accelerator pedal (&gt; page 251)</li> <li>• Internal combustion engine activation using the haptic accelerator pedal</li> <li>• The power meter is shown on the right-hand side of the instrument cluster (&gt; page 244).</li> </ul>

<b>E-SAVE</b>	<ul style="list-style-type: none"> <li>• Electric mode or driving with the internal combustion engine is possible</li> <li>• Automatic selection of drive mode with electric mode as often as possible</li> <li>• The current condition of charge of the high-voltage battery is maintained so the electrical energy can be used at a later time.</li> </ul>
<b>CHARGE</b>	<ul style="list-style-type: none"> <li>• Electric drive is not possible</li> <li>• The high-voltage battery is charging while driving with the combustion engine</li> </ul>

In automatic drive program **S** (▷ page 250) and in manual drive program **M** (▷ page 250), only **HYBRID** operating mode is available.

If you switch from automatic drive program **S** to automatic drive program **E** or **E+**, **HYBRID** operating mode continues to be selected.

If manual drive program **M** is deactivated, the automatic transmission shifts:

- into the automatic drive program that was last selected
- into the driving mode that was last selected

Each time the engine is started, **HYBRID** mode is automatically selected.

### Power meter

The power meter supports you in electric mode and displays the output obtained.

If you select the **E-MODE** operating mode, the instrument cluster will display the power meter instead of the tachometer.

- i** The tachometer appears again if:
- you select **HYBRID**, **E-SAVE** or **CHARGE**
  - the current state of charge of the high-voltage battery is too low to drive the vehicle in the **E-MODE** electrical operating mode



The power meter is divided into the following areas:

- Limit ① (OFF):  
If the needle reaches limit ①, the electric motor and the combustion engine are switched off.
- Area ② to ④ (CHARGE):  
This shows the recuperated energy which is stored in the high-voltage battery as electrical energy.  
The more recuperated energy the high-voltage battery has, the further needle ④ travels in direction ③. When the needle reaches limit ③, the maximum amount of recuperative braking power has been reached.  
In addition to the recuperative braking power, the mechanical brakes are activated in the area between ② and ③.
- Output range of electric motor: ④ to ⑤:  
The electric output of the electric motor is displayed here. When the power meter needle reaches position ④, the electric motor is operational. With increasing pressure on the accelerator pedal, the needle moves towards ⑤.  
The output limit of the electric motor ⑤ can be felt via the additional pressure point in the haptic accelerator pedal.  
If you do not press the haptic accelerator pedal beyond the pressure point, you can control electric operation, at low speeds, to only drive in electric mode.
- Output range of combustion engine: ⑤ to ⑥:  
The output of the combustion engine and the electric motor is displayed here. When the power meter needle reaches position ⑤ and you press the haptic accelerator pedal beyond the pressure point, then the combustion engine is switched on.

The electric motor supports the combustion engine by providing additional torque when:

- the needle has exceeded area ⑤
- you press the haptic accelerator pedal beyond the pressure point and want to obtain more power

### Operating the on-board computer

You can display the current operating condition of the hybrid drive system in the multifunction display and the multimedia system display (▷ page 245).

In the multimedia system display, you can also call up a graphic display of the fuel consumption and generated electricity (▷ page 249).

### Menus and submenus







#### Selecting displays in the display of the multimedia system

- ▶ Press button  on the controller. The vehicle menu is displayed.
- ▶ To select **Energy Flow**: turn and press the controller. The energy flow is displayed.

or

- ▶ To select **Consumption**: turn and press the controller. Fuel consumption and the generated electric energy are displayed.
- ▶ To exit the display: press the  button on the controller.

#### Selecting the energy flow display in the multifunction display

- ▶ Use  on the steering wheel to call up the list of menus.
- ▶ Press the  or  button on the steering wheel to select the **Trip** menu.
- ▶ Confirm by pressing  on the steering wheel.
- ▶ Select **Energy Flow** with  or  . The active hybrid components are highlighted in the energy flow display.

### Energy flow display

#### Overview

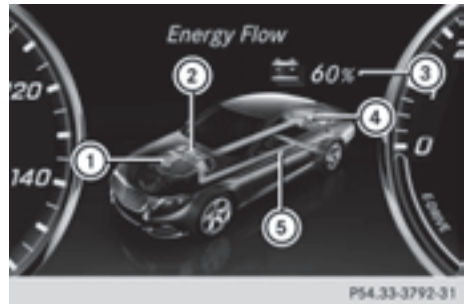

- ① Internal combustion engine
- ② Electric motor
- ③ High-voltage battery condition of charge
- ④ High-voltage battery
- ⑤ Energy flow

The active hybrid components are highlighted. The energy flow is indicated by arrows. The arrows have a different color depending on the operating state.

#### Automatic engine switch-off

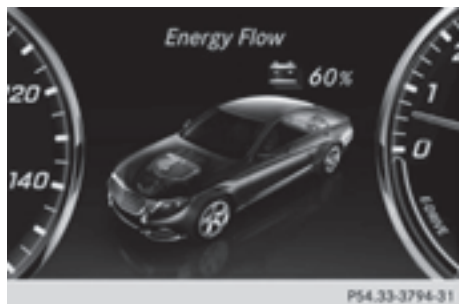

The engine and electric motor are switched off. The arrows for the energy flow are not shown. The condition of charge of the high-voltage battery is shown when the SmartKey is in position 2 in the ignition lock.

**Engine running while vehicle is stationary**

The combustion engine is running while the vehicle is stationary. The high-voltage battery is not being charged.

The arrows for the energy flow are not shown. The combustion engine is highlighted.

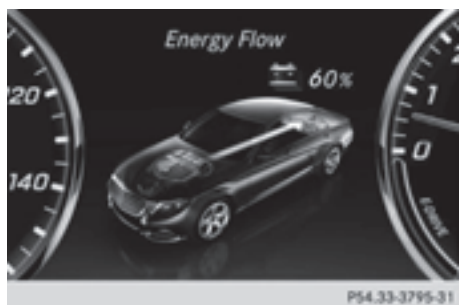
**Charging while vehicle is stationary**

The engine powers the electric motor. The electric motor operates as a generator. The high-voltage battery is being charged.

The arrow representing energy flow is shown in white.

**Driving using the engine**

The engine powers the vehicle.

The arrows for the energy flow are shown in white.

**Driving using the engine plus boost mode**

If you rapidly depress the accelerator, the electric motor supports the internal combustion engine by providing additional torque.

The arrows for the energy flow are shown in red.

**Driving using the engine plus energy recovery**

The engine powers the vehicle. The electric motor is operating as a generator, e.g. in over-run mode and when braking (> page 253). The kinetic energy of the vehicle is converted into electrical energy. The high-voltage battery is being charged.

The arrows for the energy flow are shown in green.



### Driving using the internal combustion engine and charging the high-voltage battery



The engine powers the vehicle. The engine also powers the electric motor. The electric motor operates as a generator. The high-voltage battery is being charged.

The arrows for the energy flow are shown in white.

### Driving using the internal combustion engine and discharging the high-voltage battery



The engine powers the vehicle. If the vehicle is approaching a downhill gradient with a high potential for energy recuperation, the condition of charge of the high-voltage battery is intentionally kept low or intentionally reduced.

The arrows for the energy flow are shown in white.

Further information on the route-based operating strategy (▷ page 253).

### Electric operation mode



The electric motor powers the vehicle. The high-voltage battery supplies energy to the electric motor.

The arrows for the energy flow are shown in green.

### Electric operation mode and charging the high-voltage battery



The electric motor is operating as a generator, e.g. in overrun mode and when braking (▷ page 253). The kinetic energy of the vehicle is converted into electrical energy. The high-voltage battery is being charged.

The arrows for the energy flow are shown in green.

### Charging the high-voltage battery when stationary

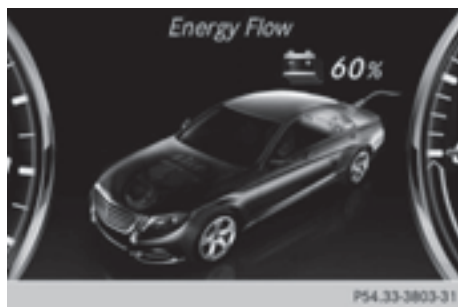







The engine and electric motor are switched off. The arrows for the energy flow are not shown. Further information on charging the high-voltage battery via:

- a mains socket (▷ page 183)
- a charging station (▷ page 186)
- a wallbox (▷ page 185)

### Displaying the total range and electrical range



The approximate range is based on the current driving style.

- ▶ Use  on the steering wheel to call up the list of menus.
- ▶ Press the  or  button on the steering wheel to select the **Trip** menu.
- ▶ Confirm by pressing  on the steering wheel.
- ▶ Press  or  to select the approximate total range and electrical range.

## Displaying fuel consumption and generated electricity

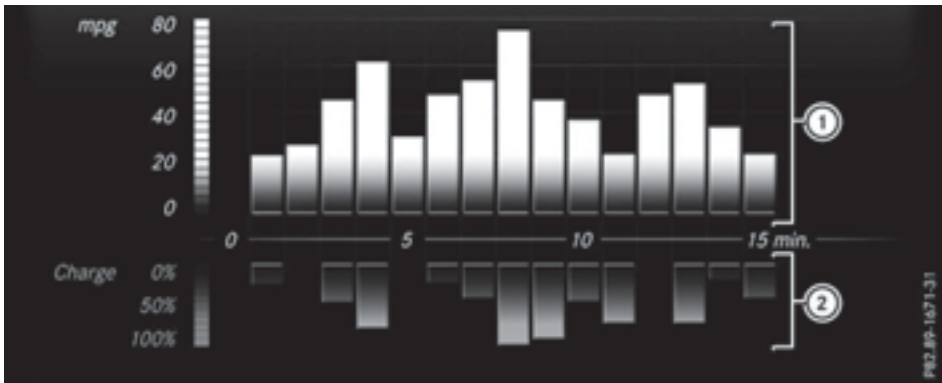

- ① Fuel consumption
- ② Electrical energy generated

Every bar of the graph displays the average value for one minute.

Fuel consumption indicator ① may differ from the indicator in the **From Start** trip computer in the **Trip** menu.

**To reset the values:** the values are reset along with the **From Start** trip computer (▷ page 262).

- ▶ To select **Consumption**: turn and press the controller.

Fuel consumption ① and electrical energy ② generated for the last 15 minutes are shown in the COMAND display.

### Starting the engine

The vehicle starts in electric mode without the internal combustion engine (noiseless start). The internal combustion engine starts only after the power demanded by the driver exceeds the available power that the electric motor can currently provide.

Noiseless start operation is dependent on the outside temperature and the operating temperature of the internal combustion engine. If not all conditions for noiseless start operation are fulfilled, the vehicle starts with the internal combustion engine.



- ▶ Switch on the ignition.
- ▶ Depress the brake pedal.
- ▶ Observe the notes on starting the engine (▷ page 164).
- ▶ Start the vehicle (▷ page 164).  
The vehicle is operational when READY indicator ① lights up.

### Pulling away

- ▶ Depress the brake pedal and keep it depressed.
- ▶ Shift the transmission to position **D** or **R**.
- ▶ If the **Apply Brake to Shift from 'P'** display message appears in the multifunction display, depress the brake pedal more firmly and select the desired transmission position.
- ▶ Release the brake pedal.
- ▶ Carefully depress the accelerator pedal.

For further information on pulling away (▷ page 165).

### Driving

#### Program selector button

#### Automatic drive programs **E**, **S** and **E+**



- ▶ Press program selector button ① to change the drive program. The selected drive program appears in the multifunction display.

The program selector button allows you to choose between different driving characteristics.

<b>E</b> Economy	<ul style="list-style-type: none"> <li>• Comfortable, economical driving</li> <li>• Electric operation mode is used as often as possible</li> <li>• ECO start/stop function is available</li> </ul>
<b>S</b> Sport	<ul style="list-style-type: none"> <li>• Sporty driving style with boost mode</li> <li>• The internal combustion engine is always switched on</li> </ul>
<b>E+</b> Economy Plus	<ul style="list-style-type: none"> <li>• Comfortable, economical driving</li> <li>• Electric operation mode is used as often as possible</li> <li>• The ECO start/stop function is available</li> <li>• Double pulses in the haptic accelerator pedal, as an indication to release the accelerator pedal (▷ page 251)</li> <li>• After the accelerator pedal has been released, the coasting characteristics of the vehicle are adapted to the traffic conditions</li> </ul>

For further information on the automatic drive program, see (▷ page 174).

#### Manual drive program

In addition to automatic drive programs **E** and **S**, you can switch to manual drive program **M** using the steering wheel paddle shifters.

In manual drive program **M**, you can briefly change gear yourself by using the steering wheel paddle shifters. The transmission must be in position **D**. In manual drive program **M** the internal combustion engine is always switched on.

Activating when driving with the electric motor:

- ▶ Pull the left or right steering wheel paddle shifter (▷ page 174).  
The combustion engine is switched on. Manual drive program **M** is temporarily activated. The selected gear and **M** appear in the multi-function display.

Activating when driving with the combustion engine:

- ▶ Pull the left or right steering wheel paddle shifter (▷ page 174).  
Manual drive program **M** is temporarily activated. The selected gear and **M** appear in the multifunction display.

The ECO start/stop function is not available in manual drive program **M**.

## Haptic accelerator pedal

### General notes

The haptic accelerator pedal helps you to reduce the fuel consumption and emissions of your vehicle.

There are two different functions available for this purpose:

- an additional point of resistance in **E-MODE** operating mode (▷ page 243)
- a double impulse in **E+** operating mode (▷ page 250)

### Additional point of resistance in the haptic accelerator pedal

The maximum available electric performance is indicated by a tangible point of resistance in the haptic accelerator pedal.

The additional point of resistance is available in **E-MODE** operating mode (▷ page 243).

If you depress the haptic accelerator pedal beyond the pressure point, the combustion engine is switched on.

### Double pulses in the haptic accelerator pedal

A tangible double pulse in the haptic accelerator pedal gives you a recommendation to release the accelerator pedal. The combustion engine can switch off and be disconnected from the drive train (overrun mode).

The double pulse is available in drive program **E+** (▷ page 250).

After the accelerator pedal has been released, the coasting characteristics of the vehicle are adapted to the traffic conditions.

To avoid getting too close to the vehicle in front, you must apply the brakes manually when necessary.

## Driving tips

### General driving tips

Drive carefully and maintain a safe distance from the vehicle in front. Avoid frequent and sudden acceleration as well as abrupt braking.

During partial electric driving, pulling away and acceleration, the electric motor supports the internal combustion engine.

During overrun in transmission position **D** and braking, the electric motor will operate as a generator.

Further information on the ECO start/stop function (▷ page 252).

Additional driving tips (▷ page 192).

### Stationary vehicle

If the vehicle is stopped, the combustion engine is, for the most part, switched off. Automatic climate control continues to function. The electromechanically assisted steering gear allows you to use the power steering without reduced comfort.

### Acceleration

Depending on the operating mode, pulling away and driving under low load conditions are performed:

- entirely by electric propulsion
- in combination with the internal combustion engine

When accelerating at an increased or full load, boost mode is utilized. The electric motor supports the internal combustion engine by providing additional torque when the accelerator is depressed rapidly.

### Overrun mode or braking

There are three possible operating modes when the hybrid vehicle is decelerating:

- energy recovery takes place even when the vehicle is decelerating purely in overrun mode (▷ page 240). The electric motor operates as

a generator and stores the recovered energy in the high-voltage battery

- when the brakes are applied lightly, the vehicle is slowed down further by the electric motor. This increases the energy recovery taking place (▷ page 240). The electric motor operates as a generator and stores the recovered energy in the high-voltage battery
- when the brakes are applied with greater force, the service brakes are also used to slow the vehicle down. The two systems work together

### Urban driving

Energy is recuperated during frequent deceleration and stopping in city traffic.

The vehicle can be driven by the electric motor alone up to a speed of approximately 81 mph (130 km/h).

The vehicle is driven by the electric motor alone only when all conditions for the automatic engine switch-off are fulfilled.

Further information on the automatic engine switch-off (▷ page 252).

### Driving on inter-urban roads

The following phases are possible when driving on inter-urban roads:

- rapid acceleration (boost mode)
- constant energy consumption
- energy recuperation
- electric operation mode

A great deal of recovered energy may be available, depending on the route profile. This reduces consumption and emissions.

### Highway driving

During highway driving, fuel consumption and emissions are favorably influenced in particular by reduced power losses.

The internal combustion engine will be switched off automatically, if:

- the driver removes his or her foot from the accelerator pedal in drive program **E** and a speed of 81 mph (130 km/h) is not exceeded
- the driver removes his or her foot from the accelerator pedal in drive program **E+** and a speed of 112 mph (180 km/h) is not exceeded

Further information on the automatic engine switch-off (▷ page 252).

## ECO start/stop function

### General notes

The ECO start/stop function switches the internal combustion engine off automatically when the vehicle stops moving and at high speeds (▷ page 253).

All vehicle systems remain active, e.g. the automatic climate control.

The ECO start/stop function is only available in drive programs **E** and **E+**. Electric-only operation is only possible in drive programs **E** and **E+**.

Additional information for drive programs **E** and **E+** (▷ page 250).

### Automatic engine switch-off

The engine is switched off automatically, including when:

- the driver removes his or her foot from the accelerator pedal in drive program **E** and a speed of 81 mph (130 km/h) is not exceeded (▷ page 253)
- the driver removes his or her foot from the accelerator pedal in drive program **E+** and a speed of 112 mph (180 km/h) is not exceeded (▷ page 253)
- the engine has reached its operating temperature
- the driver's seat belt is fastened and the driver's door is closed
- the driver only slightly depresses the accelerator pedal in order to, for example, maintain the current speed for a limited distance
- the hood is closed and engaged properly
- the high-voltage battery is charged sufficiently
- no malfunctions are present in the hybrid drive system

The internal combustion engine will not be switched off automatically, if:

- the self-diagnosis function of the engine control unit is still active
- there is a malfunction in the hybrid drive system
- the climate control of the vehicle requires it
- the high-voltage battery is being charged (▷ page 246)
- automatic emissions tests are running

### Automatic engine start

The automatically switched-off internal combustion engine starts automatically in certain situations, if:

- the power demand from the driver via the accelerator pedal is greater than the electric motor alone can provide
- the driver switches to drive program **S** or **M**
- the condition of charge of the high-voltage battery has reached the lower limit
- the settings of the automatic climate control require it, e.g. at external temperatures above 30 °C

### Overrun mode

In overrun mode, the combustion engine is switched off and is disconnected from the drive train. The electric motor:

- generates low thrust, which corresponds to the overrun mode of an active combustion engine
- functions as a generator and produces the necessary energy for the auxiliary consumers and charges the high-voltage battery

Overrun mode is possible in the following speed range:

- in drive program **E** below 81 mph (130 km/h)
- in drive program **E+** below 112 mph (180 km/h)

In drive program **E+**, after the accelerator pedal has been released the coasting characteristics of the vehicle are adapted to the traffic conditions. Further information about the haptic accelerator pedal (▷ page 251).

### Route-based operating strategy

For the route-based operating strategy, the system factors in information about the expected route when route guidance is active.

The information on the route is provided by the multimedia system and includes the following:

- road categories
- speed limitations
- data on downhill gradients

The use of electric energy is automatically optimally distributed from the beginning to the end of the journey, using information about the route. The distribution is pre-emptive and takes into consideration:

- the sections of the journey ahead
- the energy consumption on the whole route

The condition of charge of the high-voltage battery is thus systematically controlled. In addition, the control function takes into account that:

- the fuel savings through the use of electrical energy can vary, depending on the route (e.g. urban, interurban or highway)
- the use of electrical energy is held available in particular for electric operation (e.g. urban routes)

The vehicle thus automatically selects the optimum driving mode for the respective section of the route.

The route-based operating strategy is available under the following conditions:

- drive program **E+** is selected
- **HYBRID** driving mode is selected
- active route guidance is activated
- suitable map data is available

When the route-based operating strategy is being used, the area in front of the vehicle is shown as green in the multifunction display.

### Parking

- ▶ Apply the electric parking brake. The red  indicator lamp in the instrument cluster lights up.
- ▶ Use the DIRECT SELECT lever to shift the automatic transmission to **P**.
- ▶ Switch the ignition off. The READY indicator in the instrument cluster goes out.

Further information on parking and switching off the internal combustion engine (▷ page 190).

## Problems with PLUG-IN HYBRID operation

### Internal combustion engine

Problem	Possible causes/consequences and ► Solutions
You cannot start the internal combustion engine. The multifunction display shows no display messages. The READY indicator in the multifunction display is off.	<p>For example, self-diagnosis is not yet complete or the hybrid drive system is malfunctioning.</p> <ul style="list-style-type: none"> <li>► Switch off the ignition and turn it back on.</li> <li>► Try to start the internal combustion engine again.</li> </ul> <p>If the internal combustion engine still does not start:</p> <ul style="list-style-type: none"> <li>► Consult a qualified specialist workshop.</li> </ul>
You wish to pull away, but the ECO start/stop function does not start the internal combustion engine. The READY indicator in the multifunction display is off.	<p>The ECO start/stop function has failed. The warning and indicator lamps in the instrument cluster light up.</p> <ul style="list-style-type: none"> <li>► Shift the transmission to <b>P</b>.</li> <li>► Switch off the ignition and turn it back on.</li> <li>► Start the engine.</li> </ul>
	<p>The hybrid drive system is faulty.</p> <ul style="list-style-type: none"> <li>► Consult a qualified specialist workshop.</li> </ul>

### Regenerative Brake System

Problem	Possible causes/consequences and ► Solutions
Braking resistance is reduced and brake pedal travel is longer than usual.	<p> <b>Risk of accident</b></p> <p>The Regenerative Brake System is malfunctioning.</p> <ul style="list-style-type: none"> <li>► Observe the additional display messages in the multifunction display (► page 277).</li> <li>► Observe the information regarding indicator and warning lamps in the instrument cluster (► page 315).</li> </ul>



## Hybrid drive system

Problem	Possible causes/consequences and ► Solutions
<p>The hybrid drive system has been switched off automatically.</p>	<p>You have been in an accident.</p> <p>The hybrid drive system remains switched off if:</p> <ul style="list-style-type: none"> <li>• the internal combustion engine cannot be restarted after a few seconds.</li> <li>• the red  restraint system warning lamp in the instrument cluster is lit.</li> </ul> <p>► Consult a qualified specialist workshop.</p>
<p>The hybrid drive system has been switched off automatically. The multifunction display also shows a display message.</p>	<p>An electrical short circuit has occurred in the hybrid drive system or an electrical connection has been disconnected.</p> <ul style="list-style-type: none"> <li>► Observe the additional display messages in the multifunction display (► page 277).</li> <li>► Consult a qualified specialist workshop.</li> </ul>

### Useful information

- i** This Operator's Manual describes all models and all standard and optional equipment of your vehicle available at the time of publication of the Operator's Manual. Country-specific differences are possible. Please note that your vehicle may not be equipped with all features described. This also applies to safety-related systems and functions.
- i** Read the information on qualified specialist workshops (> page 28).

### Important safety notes

#### WARNING

If you operate information systems and communication equipment integrated in the vehicle while driving, you will be distracted from traffic conditions. You could also lose control of the vehicle. There is a risk of an accident. Only operate the equipment when the traffic situation permits. If you are not sure that this is possible, park the vehicle paying attention to traffic conditions and operate the equipment when the vehicle is stationary.

You must observe the legal requirements for the country in which you are currently driving when operating the on-board computer.

#### PLUG-IN HYBRID vehicles only:

#### WARNING

If the instrument cluster has failed or malfunctioned, you may not recognize function restrictions in systems relevant to safety. The operating safety of your vehicle may be impaired. There is a risk of an accident.

Pull over as soon as it is safe to do so and consult a qualified specialist workshop.

#### All vehicles, except PLUG-IN HYBRID vehicles:

#### WARNING

If the instrument cluster has failed or malfunctioned, you may not recognize function restrictions in systems relevant to safety. The

operating safety of your vehicle may be impaired. There is a risk of an accident.

Drive on carefully. Have the vehicle checked at a qualified specialist workshop immediately.

If the operating safety of your vehicle is impaired, pull over as soon as it is safe to do so. Contact a qualified specialist workshop.

The on-board computer only shows messages or warnings from certain systems in the multifunction display. You should therefore make sure your vehicle is operating safely at all times.

For an overview, see the instrument panel illustration (> page 33).

### Displays and operation



#### Instrument cluster lighting

The light sensor in the instrument cluster automatically controls the brightness of the multifunction display. In daylight, the displays in the instrument cluster are illuminated. A dimming function is not possible in daylight.

The lighting in the instrument cluster, in the displays and the controls in the vehicle interior can be adjusted using the brightness control knob.

The brightness control is located between the instrument cluster and the multimedia system display (> page 35).

- Turn the brightness control knob clockwise or counter-clockwise.

If you turn the light switch (> page 130) to the , **AUTO** or  position, the brightness will depend upon the brightness of the ambient light.

#### Tachometer

- !** Do not drive in the overrevving range, as this could damage the engine.

The red band in the tachometer indicates the engine's overrevving range.

The fuel supply is interrupted to protect the engine when the red band is reached.

PLUG-IN HYBRID vehicles: if you select the operating mode **E-MODE**, the display in the instrument cluster changes from tachometer to power meter (> page 242).

## Outside temperature display

You should pay special attention to road conditions when temperatures are around freezing point.

Bear in mind that the outside temperature display indicates the temperature measured and does not record the road temperature.

The outside temperature display is in the multifunction display (▷ page 258).

There is a short delay before a change in outside temperature is shown in the multifunction display.

## Coolant temperature display

### WARNING

Opening the hood when the engine is overheated or when there is a fire in the engine compartment could expose you to hot gases or other service products. There is a risk of injury.

Let an overheated engine cool down before opening the hood. If there is a fire in the engine compartment, keep the hood closed and contact the fire department.

**!** A display message is shown if the coolant temperature is too high.

If the coolant temperature is above 257 °F (125 °C) do not drive any further. The engine will otherwise be damaged.

All vehicles except PLUG-IN HYBRID vehicles: the coolant temperature gauge is in the lower area of the tachometer (▷ page 33).

PLUG-IN HYBRID vehicles: the multifunction display shows the coolant temperature in the **Coolant** submenu (▷ page 269).

Under normal operating conditions and with the specified coolant level, the coolant temperature may rise to 255 °F (124 °C).

## Operating the on-board computer



- ① Multifunction display
- ② Right control panel
- ③ Left control panel

▶ **To activate the on-board computer:** turn the SmartKey to position **1** in the ignition lock.

You can control the multifunction display and the settings in the on-board computer using the buttons on the multifunction steering wheel.

### Left control panel



- Opens the menu list







#### Press briefly:

- Scrolls in lists
- Selects a menu or function
- In the **Radio** or **Media** menu: opens the track or station list and selects a station, an audio track or a video scene
- In the **Telephone** menu: switches to the phone book and selects a name or a telephone number







#### Press and hold:

- Scrolls quickly through all lists
- In the **Radio** or **Media** menu: selects a station, audio track or video scene using rapid scrolling
- In the **Telephone** menu: starts rapid scrolling if the phone book is open

	<ul style="list-style-type: none"> <li>In all menus: confirms the selected entry in the list</li> <li>In the <b>Radio</b> or <b>Media</b> menu: opens the list of available radio sources or media</li> <li>In the <b>Telephone</b> menu: switches to the phone book and starts dialing the selected number</li> </ul>
	<ul style="list-style-type: none"> <li>Switches off the Voice Control System (see the separate operating instructions)</li> </ul>
	<p><b>Press briefly:</b></p> <ul style="list-style-type: none"> <li>Back</li> <li>In the <b>Radio</b> or <b>Media</b> menu: deselects the track or station list or list of available radio sources or media</li> <li>Hides display messages</li> <li>Exits the telephone book/redial memory</li> </ul>
	<p><b>Press and hold:</b></p> <ul style="list-style-type: none"> <li>Calls up the standard display in the <b>Trip</b> menu</li> </ul>

### Right control panel

	<ul style="list-style-type: none"> <li>Rejects or ends a call</li> <li>Exits the telephone book/redial memory</li> </ul>
	<ul style="list-style-type: none"> <li>Makes or accepts a call</li> <li>Switches to the redial memory</li> </ul>
	<ul style="list-style-type: none"> <li>Adjusts the volume</li> </ul>
	<ul style="list-style-type: none"> <li>Mute</li> </ul>
	<ul style="list-style-type: none"> <li>Switches on the Voice Control System (see the separate operating instructions)</li> </ul>

### Multifunction display







- ① Top status bar
- ② Display
- ③ Bottom status bar

Display panel ② shows the selected menu or submenu and display messages.





► **To open the menu list:** press the  button on the steering wheel.

The menu list appears in display panel ②.

#### Possible top status bar displays:

- -- °F Outside temperature (▷ page 257)
-  Turn signal, left (▷ page 131)
-  Low-beam headlamps (▷ page 131)
-  High-beam headlamps (▷ page 132)
-  Parking lamps and license plate lighting (▷ page 131)
-  Turn signal, right (▷ page 131)

#### Possible bottom status bar displays:

-  ECO start/stop function (▷ page 166)
- **READY** PLUG-IN HYBRID operation activated (▷ page 249)
- **HYBRID** Operating mode display in PLUG-IN HYBRID vehicles, further displays (▷ page 242)
-  Electric range (PLUG-IN HYBRID vehicles)
- **HOLD** HOLD function (▷ page 208)
- **P** Active Parking Assist (▷ page 216)
-  Adaptive Highbeam Assist Plus (▷ page 133)
-  DISTRONIC PLUS Steering Assist and Stop&Go Pilot (▷ page 207)
- --- km/h Additional speedometer (▷ page 274)

## Head-up display

### General notes

The head-up display projects information from the navigation system and the driver assistance system above the dashboard into the driver's field of vision. The head-up display allows the driver to see all of the information without having to take their eyes off the road.

A requirement for the display of the contents is that the following functions are available in the vehicle and are switched on:

- Cruise control
- DISTRONIC PLUS
- Traffic Sign Assist
- Navigation

### Important safety notes

The head-up display is only an aid and is not a substitute for attentive driving.

Speed limits and overtaking restrictions are not always correctly displayed. Traffic signs always have priority over the Traffic Sign Assist display.

The visibility of the head-up display is influenced by the following conditions:

- the driver's seat position
- the positioning of the display image
- the general ambient light
- sunglasses with polarization filters
- wet roads
- blocking of sunlight by objects on the display cover

In the event of extreme sunlight, sections of the display may fade. This can be reversed by switching the head-up display off and on again.

- i** Vehicles with the head-up display are equipped with a special windshield. Should repairs be necessary, have the windshield replaced at a qualified specialist workshop.

## Displays and operation

### Switching the head-up display on/off



- Press button ①.  
When the head-up display is switched on, the display appears in the driver's field of vision.

### Standard displays in the head-up display

The head-up display shows the following contents and information.

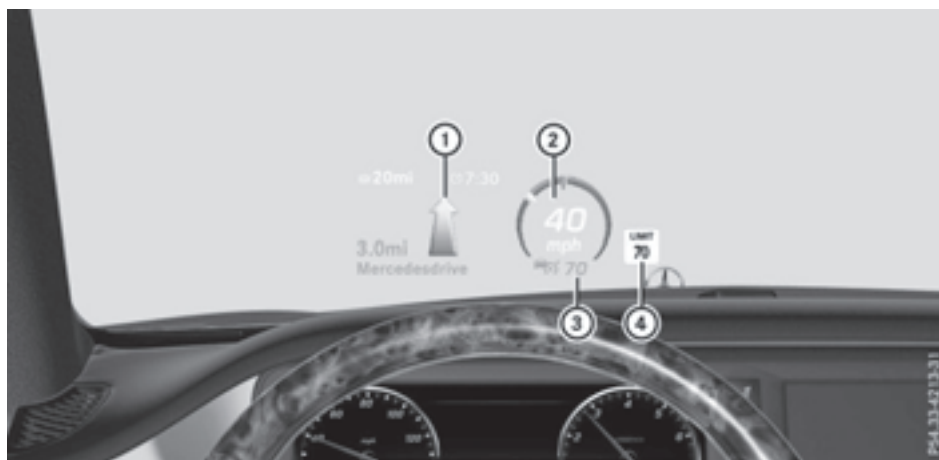

- ① Navigation messages
- ② Current speed
- ③ Cruise control or DISTRONIC PLUS set speed
- ④ Detected traffic signs

### AMG displays in the head-up display

AMG displays are only available in Mercedes-AMG vehicles.

The head-up display shows the following contents and information.



- ① Upshift indicator
- ② Currently selected gear, gearshift options when shifting manually
- ③ Current engine speed
- ④ Current speed

## Setting options

You can adjust the following settings in the head-up display submenu:

- adjust the position of the head-up display on the windshield (> page 273)
- adjust the brightness of the displays in the head-up display (> page 273)
- select displays in the head-up display (> page 273).

Using the **Display Content** function, you can, depending on your vehicle's equipment, choose between four standard displays. The selected contents then appear in the head-up display.

In Mercedes-AMG vehicles, you can also choose between two AMG displays. If you select an AMG display, the head-up display shows AMG-specific contents.

If you select a display with traffic signs, detected traffic signs from Traffic Sign Assist appear in the head-up display.

## Menus and submenus

### Menu overview

Press the  button on the steering wheel to open the menu list.

Operating the on-board computer (> page 257).

Depending on the vehicle equipment, you can select the following menu:

- **Trip** menu (> page 261)
- **Navi** menu (navigation instructions) (> page 263)
- **Radio** menu (> page 265)
- **Media** menu (> page 265)
- **Telephone** menu (> page 267)
- **Assistance Graphic** menu (> page 268)
- **Service** menu (> page 269)
- **Settings** menu (> page 269)
- **AMG** menu (Mercedes-AMG vehicles) (> page 275)

### Trip menu

#### Standard display

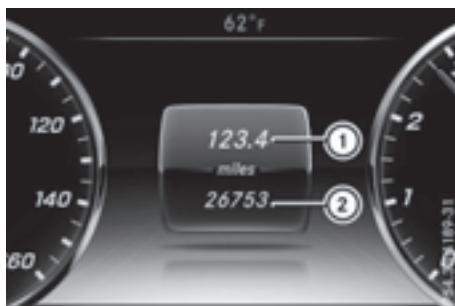







- ▶ Press and hold the  button on the steering wheel until the **Trip** menu with trip odometer ① and odometer ② appears.

#### Displaying the range and current fuel consumption



Mercedes-AMG vehicles: the menu only displays approximate range ①.

PLUG-IN HYBRID vehicles: the menu displays current fuel consumption ②. In the subsequent message, the multifunction display shows the approximate electrical range as well as the total range (> page 248).

- ▶ Press the  button on the steering wheel to open the menu list.
- ▶ Press  or  on the steering wheel to select the **Trip** menu.
- ▶ Confirm by pressing  on the steering wheel.
- ▶ Press the  or  button to select the display with approximate range ① and current fuel consumption ②. Approximate range ① that can be covered is calculated according to your current driving

style and the amount of fuel in the tank. If there is only a small amount of fuel left in the fuel tank, a vehicle being refueled  appears instead of approximate range ①.







Recuperation display ③ shows you if energy has been recuperated from the kinetic energy in overrun mode and saved in the battery.

Recuperation display ③ depends on the engine installed and is therefore not available in all vehicles.

## ECO display



The ECO display is not available in Mercedes-AMG vehicles.

- ▶ Press the  button on the steering wheel to open the menu list.
- ▶ Press  or  on the steering wheel to select the **Trip** menu.
- ▶ Confirm by pressing  on the steering wheel.
- ▶ Press the  or  button to select **ECO Display**.







If the ignition remains switched off for longer than four hours, the ECO display will be automatically reset.

For more information on the ECO display, see (> page 193).

## Trip computer "From Start" or "From Reset"



- ① Odometer
- ② Driving time
- ③ Average speed
- ④ PLUG-IN HYBRID vehicles: emission-free trip distance
- ⑤ Average fuel consumption

- ▶ Press the  button on the steering wheel to open the menu list.
- ▶ Press  or  on the steering wheel to select the **Trip** menu.
- ▶ Confirm by pressing  on the steering wheel.
- ▶ Select **From Start** or **From Reset** with  or .

The values in the **From Start** submenu are calculated from the start of a journey, while the values in the **From Reset** submenu are calculated from the last time the submenu was reset (> page 263).

In the following cases the trip computer is automatically reset **From Start**:

- the ignition has been switched off for more than four hours.
- 999 hours have been exceeded.
- 9,999 miles have been exceeded.

When 9,999 hours or 99,999 miles have been exceeded, the trip computer is automatically reset **From Reset**.



## Digital speedometer



- ▶ Press the button on the steering wheel to open the menu list.
- ▶ Press or on the steering wheel to select the **Trip** menu.
- ▶ Confirm by pressing on the steering wheel.
- ▶ Press the or button to select the digital speedometer.

## Resetting values



- ▶ Press the button on the steering wheel to open the menu list.
- ▶ Press or on the steering wheel to select the **Trip** menu.
- ▶ Confirm by pressing on the steering wheel.
- ▶ Press the or button to select the function that you wish to reset.
- ▶ Press to confirm your selection.
- ▶ Press to select **Yes** and confirm with .

You can reset the values of the following functions:

- Trip odometer
- "From Start" trip computer

- "From Reset" trip computer
- ECO display

If you reset the values in the ECO display, the values in the "From Start" trip computer are also reset. If you reset the values in the "From Start" trip computer, the values in the ECO display are also reset.

## Navigation system menu

### Displaying navigation instructions

In the **Navi** menu, the multifunction display shows navigation instructions. You can find further information on navigation instructions in the separate operating instructions.

- ▶ Switch on the multimedia system (see separate operating instructions).
- ▶ Press the button on the steering wheel to open the menu list.
- ▶ Press or on the steering wheel to select the **Navi** menu.
- ▶ Confirm by pressing on the steering wheel.

### Route guidance not active



- ① Direction of travel
- ② Current road

## Route guidance active

### No change of direction announced



- ① Distance to the next destination
- ② Estimated arrival time
- ③ Distance to the next change of direction
- ④ Current road

### Change of direction announced with a lane recommendation



- ① Road into which the change of direction leads
- ② Distance to the change of direction
- ③ Change-of-direction symbol
- ④ Lane not recommended (dark gray)
- ⑤ Possible lane (light gray)
- ⑥ Recommended lane and new lane during a change of direction (white)

On multilane roads, new lane recommendations can be displayed for the next change of direction if the digital map supports this data. During the change of direction, new lanes may be added.

Lane not recommended ④: you will not be able to complete the next change of direction if you stay in this lane.

Possible lane ⑤: you will only be able to complete the next change of direction in this lane.

Recommended lane ⑥: in this lane you will be able to complete the next change of direction and the one after that.

### Change of direction without lane recommendation



- ① Road into which the change of direction leads
- ② Distance to change of direction and visual distance display
- ③ Change-of-direction symbol

When a change of direction is to be made, you will see symbol ③ for the change of direction and distance graphic ②. The distance indicator shortens towards the top of the display as you approach the point of the announced change of direction. The change of direction starts once the distance display reaches zero.

### Change of direction with lane recommendation



- ① Road into which the change of direction leads
- ② Distance to change of direction and visual distance display
- ③ Change-of-direction symbol
- ④ Lane recommendation

## Other status indicators of the navigation system



① Additional information

Other possible additional information:

- **New Route... or Calculating Route...**

A new route is calculated.

- **Road Not Mapped**

The vehicle position is inside the area of the digital map but the road is not recognized, e.g. newly built streets, car parks or private land.

- **No Route**

No route could be calculated to the selected destination.

- 

You have reached the destination or an intermediate destination.

## Radio menu



① Frequency range















② Station frequency with memory position

③ Name of artist

④ Name of track

⑤ Genre

The multifunction display shows station ② with station frequency or station name. The preset position is only displayed along with station ② if this has been stored. You can store radio stations in the multimedia system.

- ▶ Switch on the multimedia system (see separate operating instructions).
- ▶ Press the  button on the steering wheel to open the menu list.
- ▶ Press  or  on the steering wheel to select the **Radio** menu.
- ▶ Confirm by pressing  on the steering wheel. Currently set station ② appears in the multifunction display.
- ▶ **To open the station list:** press the  or  button briefly.
- ▶ **To select a station in the station list:** press the  or  button briefly.
- ▶ **To select a station in the station list using rapid scrolling:** press and hold the  or  button.
- ▶ **To select the frequency range or station memory:** press  briefly.
- ▶ Press  or  to select the frequency range or station memory.
- ▶ Press  to confirm the selection.

 SIRIUS XM satellite radio functions like a normal radio.





Further information on radio operation can be found in the multimedia system (see the separate operating instructions).

## Media menu

### Changing the media source



You can change the media source and playback mode (audio, video or TV) at any time in the **Media** menu.

- ▶ Switch on the multimedia system (see separate operating instructions).
- ▶ Press the  button on the steering wheel to open the menu list.
- ▶ Press  or  on the steering wheel to select the **Media** menu.
- ▶ Confirm by pressing  on the steering wheel.
- ▶ **To open/close the media sources list:** press  briefly. The list shows the following media sources, for example:
  - Disc (CD/DVD)
  - SD memory card
  - Media Register
  - USB storage device
  - Bluetooth® capable audio device















Please observe further information on media support and media operation in the multimedia system (see separate operating instructions).

### Operating an audio player or audio media



- ① Media source, e.g. name of current CD
- ② Current title
- ③ Name of artist
- ④ Name of album
- ⑤ Folder name

Audio data from various audio devices or media can be played, depending on the equipment installed in the vehicle.

- ▶ Switch on the multimedia system (see separate operating instructions).
- ▶ Press the  button on the steering wheel to open the menu list.
- ▶ Press  or  on the steering wheel to select the **Media** menu.
- ▶ Confirm by pressing  on the steering wheel.
- ▶ **To select an audio player or data carrier:** press  briefly. The list containing the media sources appears.
  - ▶ Press  or  to select the corresponding audio player or media.
  - ▶ Press  to confirm the selection.
- ▶ **To open the track list:** press the  or  button briefly.
- ▶ **To select the next or previous track in the track list:** press the  or  button briefly.
- ▶ **To select a track from the track list using rapid scrolling:** press and hold  or  until the desired track is reached.

If you press and hold the button, the speed of rapid scroll increases after a short time. Not all audio drives or data carriers support this function.









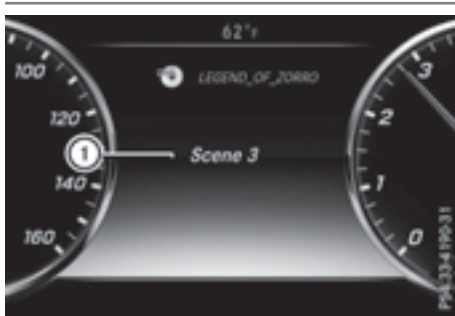





If the corresponding track information is stored on the audio drive or audio media, the multi-function display may display the following:

- track number
- track name
- artist
- album

The track information is not available in audio AUX mode (**A**uxiliary audio mode: external audio source connected).

## Video DVD operation



- ▶ Switch on the multimedia system (see separate operating instructions).
- ▶ Press the  button on the steering wheel to open the menu list.
- ▶ Press  or  on the steering wheel to select the **Media** menu.
- ▶ Confirm by pressing  on the steering wheel.
- ▶ **To select a DVD single drive or DVD media:** press  briefly. The list containing the media sources appears.
- ▶ Press  or  to select the corresponding DVD single drive or disc.
- ▶ Press  to confirm the selection.
- ▶ **To open the scene list:** press the  or  button briefly.
- ▶ **To select the next or previous scene in the scene list:** press the  or  button briefly.
- ▶ **To select a scene from the scene list using rapid scrolling:** press and hold  or  until desired scene ① is reached.
- ▶ Press  to confirm the selection.

## Telephone menu





### Introduction

#### **WARNING**

If you operate information systems and communication equipment integrated in the vehicle while driving, you will be distracted from traffic conditions. You could also lose control of the vehicle. There is a risk of an accident.

Only operate the equipment when the traffic situation permits. If you are not sure that this is possible, park the vehicle paying attention to traffic conditions and operate the equipment when the vehicle is stationary.

When telephoning, you must observe the legal requirements for the country in which you are currently driving.

- ▶ Switch on the mobile phone (see the manufacturer's operating instructions).
- ▶ Switch on the multimedia system (see separate operating instructions).
- ▶ Establish a Bluetooth® connection to the multimedia system; see the separate operating instructions.
- ▶ Press the  button on the steering wheel to open the menu list.
- ▶ Press  or  on the steering wheel to select the **Telephone** menu.
- ▶ Confirm by pressing  on the steering wheel.

You will see one of the following display messages in the multifunction display:

- **Phone READY** or the name of the network provider: the mobile phone has found a network and is ready to receive.
- **Phone No Service:** there is no network available or the mobile phone is searching for a network.

### Accepting a call



If someone calls you when you are in the **Telephone** menu, a display message appears in the multifunction display.









You can accept a call at any time regardless of the menu selected.

- ▶ Press the  button on the steering wheel to accept an incoming call.



### Rejecting or ending a call

- ▶ Press the  button on the steering wheel to reject or end a call.



### Selecting an entry in the phone book

- ▶ Press the  button on the steering wheel to open the menu list.
- ▶ Press  or  on the steering wheel to select the **Telephone** menu.
- ▶ Confirm by pressing  on the steering wheel.
- ▶ Press the ,  or  button to switch to the phone book.
- ▶ Press  or  to select the names one after the other.

or

- ▶ **To start rapid scrolling:** press and hold the  or  button for longer than one second.







The names in the phone book are displayed quickly one after the other.

If you press and hold the  or  button for longer than five seconds, the name appears with the next or previous letter initial letter in the alphabet.

Rapid scrolling stops when you release the button or reach the end of the list.

- ▶ **If only one telephone number is stored for a name:** press the  or  button to start dialing.

or











- ▶ **If there is more than one telephone number for a particular name:** press the  or  button to display the numbers.
- ▶ Press  or  to select the number you want to dial.
- ▶ Press the  or  button to start dialing.

or

- ▶ **To exit the telephone book:** press the  or  button.





### Redialing









The on-board computer saves the last names or numbers dialed in the redial memory.

- ▶ Press the  button on the steering wheel to open the menu list.
  - ▶ Press  or  on the steering wheel to select the **Telephone** menu.
  - ▶ Confirm by pressing  on the steering wheel.
  - ▶ Press the  button to switch to the redial memory.
  - ▶ Press the  or  button to select the desired name or number.
  - ▶ Press the  or  button to start dialing.
- or
- ▶ **To exit the redial memory:** press the  or  button.

### Assistance graphic menu



- ▶ Press the  button on the steering wheel to open the menu list.
- ▶ Press  or  on the steering wheel to select the **Assistance Graphic** menu.
- ▶ Confirm by pressing  on the steering wheel.  
The multifunction display shows the **DISTRONIC PLUS** distance display in the assistance graphic.  
The assistance graphic shows you the status of and/or information from other driving systems or driving safety systems:
  - **DISTRONIC PLUS** (> page 199)
  - **Spotlight function of Night View Assist Plus** (> page 274)

- Distance warning and the autonomous braking function COLLISION PREVENTION ASSIST PLUS (▷ page 71)
  - PRE-SAFE® Brake (▷ page 75)
  - Active Blind Spot Assist (▷ page 234)
  - ATTENTION ASSIST (▷ page 228)
  - Active Lane Keeping Assist (▷ page 237)
- ▶ Press  to display the ATTENTION ASSIST assessment.
- ▶ Press the  button on the steering wheel to open the menu list.
- ▶ Press  or  on the steering wheel to select the **Service** menu.
- ▶ Confirm by pressing  on the steering wheel.
- ▶ Press the  or  button to select **Coolant**.
- ▶ Press  to confirm the selection. The multifunction display shows the coolant temperature in a bar display.

## Service menu

### Introduction



Depending on the equipment installed in the vehicle, you have the following options in the **Service** menu:

- Calling up display messages in message memory (▷ page 277)
- Restarting the tire pressure loss warning system (▷ page 394)
- Checking the tire pressure electronically (▷ page 390)
- Calling up the service due date (▷ page 358).
- Displaying the coolant temperature (PLUG-IN HYBRID vehicles) (▷ page 269)
- Checking the oil level using the on-board computer (▷ page 355) (only S 600, Mercedes-Maybach S 600 and Mercedes-AMG S 65 models)

### Displaying the coolant temperature

The **Coolant** menu is only available on PLUG-IN HYBRID vehicles.

## Settings menu

### Introduction



Depending on the equipment installed in the vehicle, you have the following options in the **Settings** menu:

- Changing assistance settings (▷ page 269)
- Changing HYBRID settings (PLUG-IN HYBRID vehicles) (▷ page 272)
- Changing head-up display settings (▷ page 273)
- Changing the light settings (▷ page 274)
- Changing the instrument cluster settings (▷ page 274)
- Restoring the factory settings (▷ page 275)

## Assistance submenu

### Deactivating/activating ESP®

Observe the "Important safety notes" section in the description of ESP® (▷ page 73).

**⚠ WARNING**











If you deactivate ESP®, ESP® no longer stabilizes the vehicle. There is an increased risk of skidding and an accident.

Only deactivate ESP® in the situations described in the following.

It may be best to deactivate ESP® in the following situations:

- when using snow chains
- in deep snow
- on sand or gravel

For further information about ESP®, see (▷ page 73).

- ▶ Start the engine.
- ▶ Press the  button on the steering wheel to open the menu list.
- ▶ Press  or  on the steering wheel to select the **Settings** menu.
- ▶ Confirm by pressing  on the steering wheel.
- ▶ Use  or  to select the **DriveAssist** submenu.
- ▶ Press  to confirm your selection.
- ▶ Press the  or  button to select **ESP**.
- ▶ Press  to confirm.  
The current selection appears.
- ▶ **To activate/deactivate:** press the  button again.





ESP® is deactivated if the  warning lamp in the instrument cluster lights up continuously when the engine is running.







If the  warning lamp lights up continuously, ESP® is not available due to a malfunction.

Observe the information on warning lamps (▷ page 317).

Observe the information on display messages (▷ page 278).

**Automatic activation of Night View Assist Plus**

- ▶ Press  on the steering wheel to open the menu list.
- ▶ Press  or  on the steering wheel to select the **Settings** menu.
- ▶ Confirm by pressing  on the steering wheel.











- ▶ Use  or  to select the **DriveAssist** submenu.
- ▶ Press  to confirm your selection.
- ▶ Press the  or  button to select **Night View Assist**.
- ▶ Press  to confirm.  
The current selection appears.
- ▶ **To activate/deactivate:** press the  button again.

If Night View Assist Plus automatic activation is switched on, the night vision image is automatically shown in the multifunction display if an object is detected.

For further information about Night View Assist Plus (▷ page 232).



**Activating/deactivating Traffic Sign Assist**

Under certain conditions, the **Traffic Sign Assist** function allows you to choose if traffic signs and messages should be displayed in the lower part of the speedometer.









- ▶ Press the  button on the steering wheel to open the menu list.
- ▶ Press  or  on the steering wheel to select the **Settings** menu.
- ▶ Confirm by pressing  on the steering wheel.
- ▶ Use  or  to select the **DriveAssist** submenu.
- ▶ Press  to confirm your selection.
- ▶ Press the  or  button to select **Traffic Sign Assist**.
- ▶ Press  to confirm.  
The current selection appears.
- ▶ **To activate/deactivate:** press the  button again.  
Traffic signs and messages appear in the lower part of the speedometer if the function is activated.

For further information about Traffic Sign Assist, see (▷ page 229).

**Activating/deactivating COLLISION PREVENTION ASSIST PLUS**

- ▶ Press the  button on the steering wheel to open the menu list.
- ▶ Press  or  on the steering wheel to select the **Settings** menu.













- ▶ Confirm by pressing  on the steering wheel.
- ▶ Use  or  to select the **DriveAssist** submenu.
- ▶ Press  to confirm your selection.
- ▶ Press the  or  button to select **Collision Prevention**.
- ▶ Press  to confirm.  
The current selection appears.
- ▶ **To activate/deactivate:** press  again.

When COLLISION PREVENTION ASSIST PLUS is deactivated, the  symbol appears in the multifunction display in the **Assistance Graphic** menu.

For further information about COLLISION PREVENTION ASSIST PLUS, see (▷ page 71).

### Activating/deactivating PRE-SAFE® Brake



PRE-SAFE® Brake is only available for vehicles with the Driving Assistance Plus package.









- ▶ Press the  button on the steering wheel to open the menu list.
- ▶ Press  or  on the steering wheel to select the **Settings** menu.
- ▶ Confirm by pressing  on the steering wheel.
- ▶ Use  or  to select the **DriveAssist** submenu.
- ▶ Press  to confirm your selection.
- ▶ Press the  or  button to select **PRE-SAFE Brake**.
- ▶ Press  to confirm.  
The current selection appears.
- ▶ **To activate/deactivate:** press the  button again.

When PRE-SAFE® Brake is deactivated, the  symbol appears in the multifunction display in the **Assistance Graphic** menu.

For more information on PRE-SAFE® Brake, see (▷ page 75).

### Activating/deactivating Active Blind Spot Assist













- ▶ Press the  button on the steering wheel to open the menu list.
- ▶ Press  or  on the steering wheel to select the **Settings** menu.

- ▶ Confirm by pressing  on the steering wheel.
- ▶ Use  or  to select the **DriveAssist** submenu.
- ▶ Press  to confirm your selection.
- ▶ Press the  or  button to select **Blind Spot Assist**.
- ▶ Press  to confirm.  
The current selection appears.
- ▶ **To activate/deactivate:** press the  button again.

When Active Blind Spot Assist is activated, white radar waves propagating backwards appear next to the vehicle in the **Assistance Graphic**.

For further information about Active Blind Spot Assist, see (▷ page 234).





### Setting ATTENTION ASSIST







- ▶ Press the  button on the steering wheel to open the menu list.
- ▶ Press  or  on the steering wheel to select the **Settings** menu.
- ▶ Confirm by pressing  on the steering wheel.
- ▶ Use  or  to select the **DriveAssist** submenu.
- ▶ Press  to confirm your selection.
- ▶ Press  or  to select **ATTENTION ASSIST**.
- ▶ Press  to confirm your selection.
- ▶ Press  or  to select **Off, Standard** or **Sensitive**.
- ▶ Press the  button to confirm the selection.

When ATTENTION ASSIST is deactivated, the  symbol appears in the **Assistance Graphic** menu in the multifunction display.

For further information about ATTENTION ASSIST, see (▷ page 228).

### Activating/deactivating Active Lane Keeping Assist

- ▶ Press the  button on the steering wheel to open the menu list.
- ▶ Press  or  on the steering wheel to select the **Settings** menu.
- ▶ Confirm by pressing  on the steering wheel.

- ▶ Use  or  to select the **DriveAssist** submenu.
- ▶ Press  to confirm your selection.
- ▶ Press the  or  button to select **Lane Keeping Assist**.
- ▶ Press  to confirm.  
The current selection, **Standard** or **Adaptive**, appears.

▶ **To change the setting:** press  again.

For further information about Active Lane Keeping Assist, see (▷ page 237).

## HYBRID submenu (PLUG-IN HYBRID vehicles)

### Setting the maximum charge current

Using the **Max. Charge Current** function, you can limit the charge current value at which the high-voltage battery should be charged.







Before starting the charging process at a power socket, check the maximum permissible charge current for the relevant power socket or the building.



Only set the maximum permissible charge current using the function if:

- it is not possible to set the charge current on the charging cable
- the precise maximum permitted charge current can only be set via the on-board computer

Before charging the high-voltage battery at a wallbox or charging station, ensure that the charging current is not limited by the function. If charging at a wallbox or a charging station, select the maximum value.

Further information on charging the high-voltage battery and setting the charge current (PLUG-IN HYBRID vehicles) (▷ page 181).

- ▶ Press  on the steering wheel to open the menu list.
- ▶ Press  or  on the steering wheel to select the **Settings** menu.
- ▶ Confirm by pressing  on the steering wheel.
- ▶ Press  or  to select the **Hybrid** submenu.
- ▶ Press  to confirm.

- ▶ Press  or  to select the **Max. Charge Current** function.  
You will see the selected setting.
- ▶ Press the  button to save the setting.













Before charging the high-voltage battery, check the maximum permissible charge current for the relevant power socket.

Further information on charging the high-voltage battery (PLUG-IN HYBRID vehicles) (▷ page 181).









### Setting the departure time

You can climatize the vehicle interior prior to your departure with the "Set departure time" function. Further information on pre-entry climate control (▷ page 157).

If you recharge the high-voltage battery, the function also displays the charging prediction.

- ▶ Press the  button on the steering wheel to open the menu list.
- ▶ Press  or  on the steering wheel to select the **Settings** menu.
- ▶ Confirm by pressing  on the steering wheel.
- ▶ Press  or  to select the **Hybrid** submenu.
- ▶ Press  to confirm.
- ▶ Press  or  to select the **Departure Time** function.  
You will see the selected setting.
- ▶ Press the  button to save the setting.
- ▶ **To set no departure time:** press  or  to select **No Pre-selection**.
- ▶ Press  to confirm.  
If you recharge the high-voltage battery, the multifunction display also shows the time when the high-voltage battery will be fully charged.

or

- ▶ **To set a departure time:** press  or  **A**, **B** or **C** to select the desired preset.
- ▶ Press the  button to confirm the selection.
- ▶ Press  or  to set the hours.
- ▶ Press  to confirm.
- ▶ Press  or  to set the minutes.
- ▶ Press  to confirm.

If you recharge the high-voltage battery, the multifunction display shows the expected

condition of charge of the high-voltage battery for the departure time set.

Further information on charging the high-voltage battery (PLUG-IN HYBRID vehicles) (▷ page 181).

## Head-up display submenu

### Selecting other displays

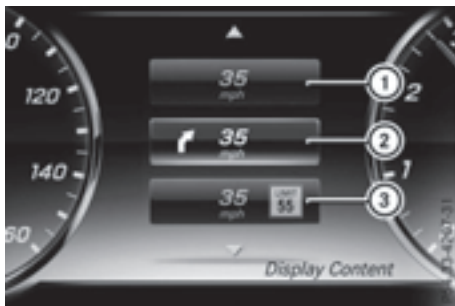

- ① Vehicle speed display
- ② Vehicle speed and navigation instruction display
- ③ Vehicle speed display and Traffic Sign Assist

Using the **Display Content** function, you can choose from up to four display options depending on the vehicle's equipment. The selected contents appear in the head-up display.

In Mercedes-AMG vehicles, you can also choose between two AMG displays. If you select an AMG display, the head-up display shows AMG-specific contents.

- ▶ Press the button on the steering wheel to open the menu list.
- ▶ Press or on the steering wheel to select the **Settings** menu.
- ▶ Confirm by pressing on the steering wheel.
- ▶ Press or to select the **Head-up Display** submenu.
- ▶ Press to confirm.
- ▶ Press or to select **Display Content**.
- ▶ Press to confirm.  
A graphic selection list appears.
- ▶ Press or to select the desired display.
- ▶ Press the button to confirm the selection.

For further information about the traffic sign displays, see Traffic Sign Assist (▷ page 229).

Further information on navigation displays can be found in the multimedia system; see the separate operating instructions.

### Setting the position

You can adjust the position of the head-up display on the windshield. You can compensate for height differences if the seat positions are changed, for example.

- ▶ Switch on the head-up display (▷ page 259).
- ▶ Press the button on the steering wheel to open the menu list.
- ▶ Press the or button on the steering wheel to select the **Settings** menu.
- ▶ Confirm by pressing on the steering wheel.
- ▶ Press or to select the **Head-up Display** submenu.
- ▶ Press to confirm.
- ▶ Press or to select the **Position** function.
- ▶ Press the button to save the setting.
- ▶ Press or to adjust the position to a level from **Level +5** (up) to **Level -5** (down).
- ▶ Press the or button to save the setting.

Using the Memory function, you can save and call up the set position of the head-up display as a single memory preset (▷ page 126).

### Setting the brightness

The brightness of the head-up display is automatically adjusted to the surrounding ambient light. You can also individually adjust the brightness of the head-up display.

- ▶ Switch on the head-up display (▷ page 259).
- ▶ Press on the steering wheel to open the menu list.
- ▶ Press the or button on the steering wheel to select the **Settings** menu.
- ▶ Confirm by pressing on the steering wheel.
- ▶ Use or to select the **Head-up Display** submenu.
- ▶ Press to confirm.
- ▶ Press or to select the **Brightness** function.
- ▶ Press the button to save the setting.

- ▶ Press or to adjust the brightness to a level from **Level +5** (bright) to **Level -5** (dark).
- ▶ Press the or button to save the setting.

### Light submenu

#### Switching the spotlight function on/off

- ▶ Press on the steering wheel to open the menu list.
- ▶ Press or on the steering wheel to select the **Settings** menu.
- ▶ Confirm by pressing on the steering wheel.
- ▶ Press or to select the **Lights** submenu.
- ▶ Press to confirm.
- ▶ Press the or button to select the **Spotlight** function.
- ▶ Press the button to save the setting. When the spotlight function is activated, the assistance graphic shows the pedestrian symbol.

Further information on the spotlight function (▷ page 232).

#### Switching the daytime running lamps on/off

This function is not available in Canada.

- ▶ Press the button on the steering wheel to open the menu list.
- ▶ Press or on the steering wheel to select the **Settings** menu.
- ▶ Confirm by pressing on the steering wheel.
- ▶ Use or to select the **Lights** submenu.
- ▶ Press to confirm.
- ▶ Using or , select the **Daytime Running Lights** function. If the **Daytime Running Lights** function has been switched on, the cone of light and the symbol are shown in white in the multifunction display.
- ▶ Press the button to save the setting.

Further information on daytime running lamps **Daytime Running Lights** (▷ page 130).

### Instrument cluster submenu

#### Selecting the distance unit

The **Display Unit Speed-/Odometer** function allows you to choose whether certain displays appear in kilometers or miles in the multifunction display.











- ▶ Press the button on the steering wheel to open the menu list.
- ▶ Press the or button on the steering wheel to select the **Settings** menu.
- ▶ Confirm by pressing on the steering wheel.
- ▶ Press or to select the **Instrument Cluster** submenu.
- ▶ Press to confirm.
- ▶ Press the or button to select the **Display Unit Speed-/Odometer** function. The current setting **km** or **Miles** appears.
- ▶ Press the button to save the setting.

The selected unit of measurement for distance applies to:











- speedometer
  - digital speedometer in the **Trip** menu
  - additional speedometer in the status area on the multifunction display
- The unit in the additional speedometer is displayed inversely to the selected distance unit.
- the odometer and trip odometer
  - the trip computer
  - the current consumption and the range
  - navigation instructions in the **Navi** menu
  - cruise control
  - SPEEDTRONIC
  - DISTRONIC PLUS
  - DISTRONIC PLUS with Steering Assist and Stop&Go Pilot
  - ASSYST PLUS service interval display

#### Switching the additional speedometer on/off

The **Additional Speedometer [km/h]** function allows you to choose whether the status area in the multifunction display shows the speed digitally. The unit in the additional speedometer is always inverse to the speedometer unit.

- ▶ Press  on the steering wheel to open the menu list.
- ▶ Press  or  on the steering wheel to select the **Settings** menu.
- ▶ Confirm by pressing  on the steering wheel.
- ▶ Press  or  to select the **Instrument Cluster** submenu.
- ▶ Press  to confirm your selection.
- ▶ Using  or , select the **Additional Speedometer [km/h]** function. The current selection appears.
- ▶ **To activate/deactivate:** press  again.

### Restoring the factory settings

- ▶ Press  on the steering wheel to open the menu list.
- ▶ Press  or  on the steering wheel to select the **Settings** menu.
- ▶ Confirm by pressing  on the steering wheel.
- ▶ Press  or  to select the **Factory Settings** submenu.
- ▶ Press  to confirm. The **Reset All Settings?** function appears.
- ▶ Press the  or  button to select **No** or **Yes**.
- ▶ Press the  button to confirm the selection. If you have selected and confirmed **Yes**, the multifunction display shows a confirmation message.





For safety reasons, the **Daytime Running Lights** function in the **Lights** submenu is only reset when the vehicle is stationary.

### AMG menu (Mercedes-AMG vehicles)

#### WARMUP



- ① Digital speedometer
- ② Gear indicator
- ③ Upshift indicator
- ④ Transmission fluid temperature
- ⑤ Engine oil temperature

- ▶ Press the  button on the steering wheel to open the menu list.
- ▶ Press  or  on the steering wheel to select the **AMG** menu.
- ▶ Confirm by pressing  on the steering wheel.







**Upshift indicator:** upshift indicator **UP** ③ indicates that the engine has reached the overrevving range when in the manual drive program.

**Engine/transmission oil temperature:** when the engine and transmission are at normal operating temperature, oil temperature ④ and ⑤ are displayed in white in the multifunction display.

If the multifunction display shows oil temperature ④ or ⑤ in blue, the engine or the transmission are not yet at normal operating temperature. Avoid driving at full engine output during this time.

## SETUP



- ① Drive program **C**, **S** or **M**
  - ② ESP® mode (**ON/OFF**)
  - ③ Suspension setting **SPORT** or **COMFORT**
- ▶ Press the  button on the steering wheel to open the menu list.
  - ▶ Press the  or  button on the steering wheel to select the **AMG** menu.
  - ▶ Confirm by pressing  on the steering wheel.
  - ▶ Press the  or  button until the **SETUP** display appears.

## Display messages

### Introduction

#### General notes

Display messages appear in the multifunction display.

Display messages with graphic displays may be shown in simplified form in the Operator's Manual and may therefore differ from the multifunction display.

Please respond in accordance with the display messages and follow the additional notes in this Operator's Manual.



With certain display messages, you will also hear a warning tone.

You can hide the display messages. The display messages are then stored in the message memory. Rectify the cause of a display message as soon as possible.

When you stop and park the vehicle, please observe the notes on:

- HOLD function (▷ page 208)
- Parking (▷ page 189)

#### Hiding display messages









- ▶ Press  or  on the steering wheel.  
The multifunction display hides the display message.

The multifunction display shows high-priority display messages in red. Some high-priority display messages cannot be hidden.

The multifunction display shows these messages continuously until the causes for the messages have been remedied.

#### Message memory

The on-board computer saves certain display messages in the **message memory**. You can call up the display messages:

- ▶ Press the  button on the steering wheel to open the menu list.
- ▶ Press  or  on the steering wheel to select the **Service** menu.
- ▶ Confirm by pressing  on the steering wheel.
- ▶ Press the  or  button to select the message memory.  
If there are no display messages, the **No Messages** message appears in the multifunction display.  
When there are display messages, the number of stored messages appears.
- ▶ Press  to confirm.
- ▶ Press the  or  button to scroll through the display messages.

## Safety systems

## Display messages





Currently Unavailable See Operator's Manual

## Possible causes/consequences and ► Solutions

ABS (Anti-lock Brake System), ESP® (Electronic Stability Program), BAS (Brake Assist), PRE-SAFE®, the HOLD function, Hill Start Assist, Crosswind Assist, STEER CONTROL, Active Lane Keeping Assist and Active Blind Spot Assist are temporarily unavailable.

BAS PLUS with Cross-Traffic Assist, PRE-SAFE® Brake, PRE-SAFE® PLUS and COLLISION PREVENTION ASSIST PLUS may also have failed.

In addition, the  and  warning lamps light up in the instrument cluster.

ATTENTION ASSIST is deactivated.

For example, the on-board voltage may be insufficient.

 **WARNING**

The brake system continues to function normally, but without the functions listed above. The wheels could therefore lock if you brake hard, for example.

The steerability and braking characteristics may be severely affected. The braking distance in an emergency braking situation can increase.

If ESP® is not operational, ESP® is unable to stabilize the vehicle.

There is an increased risk of skidding and an accident.

► Drive on carefully.

Carefully drive a suitable distance, making slight steering movements at a speed above 12 mph (20 km/h).

If the display message disappears, the functions mentioned above are available again.

If the multifunction display still shows the display message:

► Drive on carefully.



► Visit a qualified specialist workshop immediately.



Inoperative See Operator's Manual

ABS, ESP®, BAS, PRE-SAFE®, the HOLD function, Hill Start Assist, Crosswind Assist, STEER CONTROL, Active Lane Keeping Assist and Active Blind Spot are unavailable due to a malfunction.

BAS PLUS with Cross-Traffic Assist, PRE-SAFE® Brake, PRE-SAFE® PLUS and COLLISION PREVENTION ASSIST PLUS may also have failed.

The **BRAKE** (USA only) or  (Canada only),  and  warning lamps in the instrument cluster may also light up.

ATTENTION ASSIST is deactivated.



 **WARNING**









The brake system continues to function normally, but without the functions listed above. The wheels could therefore lock if you brake hard, for example.













The steerability and braking characteristics may be severely affected. The braking distance in an emergency braking situation can increase.











If ESP® is not operational, ESP® is unable to stabilize the vehicle.













Display messages	Possible causes/consequences and ► Solutions
	<p>There is an increased risk of skidding and an accident.</p> <ul style="list-style-type: none"> <li>► Drive on carefully.</li> <li>► Visit a qualified specialist workshop immediately.</li> </ul>
<div style="border: 1px solid black; padding: 2px; width: 40px; height: 40px; margin: 0 auto; text-align: center;">  </div> <p>Inoperative See Operator's Manual</p>	<p>ESP<sup>®</sup>, BAS, PRE-SAFE<sup>®</sup>, the HOLD function, Hill Start Assist, Cross-wind Assist, STEER CONTROL, Active Lane Keeping Assist and Active Blind Spot are unavailable due to a malfunction.</p> <p>BAS PLUS with Cross-Traffic Assist, PRE-SAFE<sup>®</sup> Brake, PRE-SAFE<sup>®</sup> PLUS and COLLISION PREVENTION ASSIST PLUS may also have failed.</p> <p>The  warning lamp also lights up in the instrument cluster. ATTENTION ASSIST is deactivated.</p> <p><b>⚠ WARNING</b></p> <p>The brake system continues to function normally, but without the functions listed above.</p> <p>The braking distance in an emergency braking situation can thus increase.</p> <p>If ESP<sup>®</sup> is not operational, ESP<sup>®</sup> is unable to stabilize the vehicle. There is an increased risk of skidding and an accident.</p> <ul style="list-style-type: none"> <li>► Drive on carefully.</li> <li>► Visit a qualified specialist workshop immediately.</li> </ul>

Display messages	Possible causes/consequences and ► Solutions
 <p data-bbox="82 220 318 293">Currently Unavailable See Operator's Manual</p>	<p data-bbox="342 172 1001 245">ESP®, BAS, PRE-SAFE®, the HOLD function, Hill Start Assist, Crosswind Assist, STEER CONTROL, Active Lane Keeping Assist and Active Blind Spot are unavailable due to a malfunction.</p> <p data-bbox="342 258 981 331">BAS PLUS with Cross-Traffic Assist, PRE-SAFE® Brake, PRE-SAFE® PLUS and COLLISION PREVENTION ASSIST PLUS may also have failed.</p> <p data-bbox="342 344 956 418">The  warning lamp also lights up in the instrument cluster. The self-diagnosis function might not be complete, for example. ATTENTION ASSIST is deactivated.</p> <p data-bbox="353 443 504 469"> <b>WARNING</b></p> <p data-bbox="342 485 994 558">The brake system continues to function normally, but without the functions listed above. The wheels could therefore lock if you brake hard, for example.</p> <p data-bbox="342 564 965 612">The braking distance in an emergency braking situation can thus increase.</p> <p data-bbox="342 625 969 673">If ESP® is not operational, ESP® is unable to stabilize the vehicle. There is an increased risk of skidding and an accident.</p> <p data-bbox="342 686 981 734">► Carefully drive a suitable distance, making slight steering movements at a speed above 12 mph (20 km/h).</p> <p data-bbox="365 740 1001 788">If the display message disappears, the functions mentioned above are available again.</p> <p data-bbox="342 801 913 826">If the multifunction display still shows the display message:</p> <ul data-bbox="342 839 837 896" style="list-style-type: none"> <li>► Drive on carefully.</li> <li>► Visit a qualified specialist workshop immediately.</li> </ul>
   <p data-bbox="82 1018 288 1059">Inoperative See Operator's Manual</p>	<p data-bbox="342 922 994 1024">EBD (electronic brake force distribution), ABS, ESP®, BAS, PRE-SAFE®, the HOLD function, Hill Start Assist, Crosswind Assist, STEER CONTROL, Active Lane Keeping Assist and Active Blind Spot Assist are unavailable due to a malfunction.</p> <p data-bbox="342 1031 981 1104">BAS PLUS with Cross-Traffic Assist, PRE-SAFE® Brake, PRE-SAFE® PLUS and COLLISION PREVENTION ASSIST PLUS may also have failed.</p> <p data-bbox="342 1114 994 1161">In addition, the  and  warning lamps light up in the instrument cluster and a warning tone sounds.</p> <p data-bbox="353 1181 504 1206"> <b>WARNING</b></p> <p data-bbox="342 1222 1001 1295">The brake system continues to function normally, but without the functions listed above. The front and rear wheels could therefore lock if you brake hard, for example.</p> <p data-bbox="342 1302 1001 1350">The steerability and braking characteristics may be severely affected. The braking distance in an emergency braking situation can increase.</p> <p data-bbox="342 1356 969 1404">If ESP® is not operational, ESP® is unable to stabilize the vehicle. There is an increased risk of skidding and an accident.</p> <ul data-bbox="342 1417 837 1474" style="list-style-type: none"> <li>► Drive on carefully.</li> <li>► Visit a qualified specialist workshop immediately.</li> </ul>





Display messages	Possible causes/consequences and ► Solutions
<p><b>PARK</b> (USA only)  (Canada only)</p> <p>Turn On the Ignition to Release the Parking Brake</p>	<p>The red  (USA only) or  (Canada only) indicator lamp lights up.</p> <p>You attempted to release the electric parking brake while the ignition was switched off.</p> <p>► Switch on the ignition.</p>
<p><b>PARK</b> (USA only)  (Canada only)</p> <p>Please Release Parking Brake</p>	<p>The red  (USA only) or  (Canada only) indicator lamp flashes and a warning tone sounds. A condition for automatic release of the electric parking brake is not fulfilled (► page 190).</p> <p>You are driving with the electric parking brake applied.</p> <p>► Release the electric parking brake manually.</p> <p>The red  (USA only) or  (Canada only) indicator lamp flashes and a warning tone sounds.</p> <p>You are using the electric parking brake for emergency braking (► page 190).</p>
<p><b>PARK</b> (USA only)  (Canada only)</p> <p>Parking Brake See Operator's Manual</p>	<p>The yellow  warning lamp lights up.</p> <p>The electric parking brake is malfunctioning.</p> <p><b>To apply:</b></p> <ul style="list-style-type: none"> <li>► Switch the ignition off.</li> <li>► Press the electric parking brake handle for at least ten seconds.</li> <li>► Shift the transmission to position <b>P</b>.</li> <li>► Consult a qualified specialist workshop.</li> </ul> <p>The yellow  warning lamp and the red  (USA only) or  (Canada only) indicator lamp light up.</p> <p>The electric parking brake is malfunctioning.</p> <p><b>To release:</b></p> <ul style="list-style-type: none"> <li>► Switch off the ignition and turn it back on.</li> <li>► Release the electric parking brake manually.</li> </ul> <p>or</p> <ul style="list-style-type: none"> <li>► Release the electric parking brake automatically (► page 190).</li> </ul> <p>If the electric parking brake still cannot be released:</p> <ul style="list-style-type: none"> <li>► Do not drive on.</li> <li>► Consult a qualified specialist workshop.</li> </ul>

Display messages	Possible causes/consequences and ► Solutions
	<p>The red  (USA only) or  (Canada only) indicator lamp flashes and the yellow  warning lamp lights up. The electric parking brake is malfunctioning.</p> <p><b>To release:</b></p> <ul style="list-style-type: none"> <li>► Switch off the ignition and turn it back on.</li> <li>► Release the electric parking brake manually.</li> </ul> <p><b>To apply:</b></p> <ul style="list-style-type: none"> <li>► Switch off the ignition and turn it back on.</li> <li>► Apply the electric parking brake manually.</li> </ul> <p>If the red  (USA only) or  (Canada only) indicator lamp continues to flash:</p> <ul style="list-style-type: none"> <li>► Do not drive on.</li> <li>► Secure the vehicle against rolling away (▷ page 406).</li> <li>► Shift the transmission to position <b>P</b>.</li> <li>► Turn the front wheels towards the curb.</li> <li>► Consult a qualified specialist workshop.</li> </ul>
	<p>The yellow  warning lamp lights up. The red  (USA only) or  (Canada only) indicator lamp flashes for about ten seconds after the electric parking brake has been applied or released. It then goes out or remains lit. The electric parking brake is malfunctioning.</p> <ul style="list-style-type: none"> <li>► Switch off the ignition and turn it back on.</li> <li>► Apply the electric parking brake.</li> </ul> <p>If it is not possible to engage the electric parking brake:</p> <ul style="list-style-type: none"> <li>► Shift the transmission to position <b>P</b>.</li> <li>► Visit a qualified specialist workshop.</li> </ul> <p>If it is not possible to release the electric parking brake:</p> <ul style="list-style-type: none"> <li>► Release the electric parking brake automatically (▷ page 190).</li> </ul> <p>If the electric parking brake still cannot be released:</p> <ul style="list-style-type: none"> <li>► Consult a qualified specialist workshop.</li> </ul>
	<p>The yellow  warning lamp lights up. If you manually apply or release the electric parking brake, the red  (USA only) or  (Canada only) indicator lamp flashes. The electric parking brake is malfunctioning. It is not possible to apply the electric parking brake manually.</p> <ul style="list-style-type: none"> <li>► Shift the transmission to position <b>P</b>.</li> <li>► Visit a qualified specialist workshop.</li> </ul>







Display messages	Possible causes/consequences and ► Solutions
<p><b>PARK</b> (USA only)  (Canada only)</p> <p>Parking Brake Inoperative</p>	<p>The yellow  warning lamp lights up. The red <b>PARK</b> (USA only) or  (Canada only) indicator lamp flashes for about ten seconds after the electric parking brake has been applied or released. It then goes out or remains lit.</p> <p>The electric parking brake is malfunctioning, e.g. because of overvoltage or undervoltage.</p> <ul style="list-style-type: none"> <li>► Remove the cause for the overvoltage or undervoltage, e.g. by charging the battery or restarting the engine.</li> <li>► Engage or release the electric parking brake.</li> </ul> <p>If it remains impossible to apply or release the electric parking brake:</p> <ul style="list-style-type: none"> <li>► Switch off the ignition and turn it back on.</li> <li>► Engage or release the electric parking brake.</li> </ul> <p>If the electric parking brake still cannot be released:</p> <ul style="list-style-type: none"> <li>► Consult a qualified specialist workshop.</li> </ul> <p>If the electric parking brake still cannot be applied:</p> <ul style="list-style-type: none"> <li>► Visit a qualified specialist workshop.</li> </ul> <p>The yellow  warning lamp lights up and the red <b>PARK</b> (USA only) or  (Canada only) indicator lamp flashes.</p> <p>It is not possible to apply the electric parking brake manually.</p> <ul style="list-style-type: none"> <li>► Shift the transmission to position <b>P</b>.</li> <li>► Visit a qualified specialist workshop.</li> </ul>
<p><b>BRAKE</b> (USA only)  (Canada only)</p> <p>Check Brake Fluid Level</p>	<p>There is not enough brake fluid in the brake fluid reservoir. In addition, the <b>BRAKE</b> (USA only) or  (Canada only) warning lamp lights up in the instrument cluster and a warning tone sounds.</p> <p> <b>WARNING</b></p> <p>The braking effect may be impaired. There is a risk of an accident.</p> <ul style="list-style-type: none"> <li>► Pull over and stop the vehicle safely as soon as possible, paying attention to road and traffic conditions. Do not continue driving under any circumstances.</li> <li>► Secure the vehicle against rolling away (▷ page 189).</li> <li>► Consult a qualified specialist workshop.</li> <li>► Do not add brake fluid. This does not correct the malfunction.</li> </ul>
<p></p> <p>Check Brake Pad Wear</p>	<p>The brake pads/linings have reached their wear limit.</p> <p>USA only: the red <b>BRAKE</b> brake system warning lamp also lights up while the engine is running.</p> <ul style="list-style-type: none"> <li>► Visit a qualified specialist workshop.</li> </ul>
<p></p> <p>Inoperative</p>	<p>One or more main features of the mbrace system are malfunctioning.</p> <ul style="list-style-type: none"> <li>► Visit a qualified specialist workshop.</li> </ul>







Display messages	Possible causes/consequences and ► Solutions
<p>Collision Prevention Assist Plus Currently Unavailable See Operator's Manual</p>	<p>COLLISION PREVENTION ASSIST PLUS is temporarily not operational. Possible causes are:</p> <ul style="list-style-type: none"> <li>• the radar sensor system is temporarily inoperative, e.g. due to electromagnetic radiation emitted by nearby TV or radio stations or other sources of electromagnetic radiation.</li> <li>• the system is outside the operating temperature range.</li> <li>• the on-board voltage is too low.</li> </ul> <p>When the causes stated above no longer apply, the display message disappears.</p> <p>COLLISION PREVENTION ASSIST PLUS is operational again.</p> <p>If the display message does not disappear:</p> <ul style="list-style-type: none"> <li>► Pull over and stop the vehicle safely as soon as possible, paying attention to road and traffic conditions.</li> <li>► Secure the vehicle against rolling away (▷ page 189).</li> <li>► Restart the engine.</li> </ul>
<p>Collision Prevention Assist Plus Inoperative</p>	<p>COLLISION PREVENTION ASSIST PLUS is temporarily inoperative due to a malfunction. Adaptive Brake Assist may also have failed.</p> <ul style="list-style-type: none"> <li>► Visit a qualified specialist workshop immediately.</li> </ul>
<p>PRE-SAFE Inoperative See Operator's Manual</p>	<p>Important functions of PRE-SAFE® have failed. All other occupant safety systems, e.g. air bags, remain available.</p> <ul style="list-style-type: none"> <li>► Visit a qualified specialist workshop immediately.</li> </ul>
<p>PRE-SAFE Functions Currently Limited See Operator's Manual</p>	<p>PRE-SAFE® PLUS or PRE-SAFE® Brake is temporarily inoperative. Possible causes are:</p> <ul style="list-style-type: none"> <li>• function is impaired due to heavy rain or snow.</li> <li>• the radar sensor system is temporarily inoperative, e.g. due to electromagnetic radiation emitted by nearby TV or radio stations or other sources of electromagnetic radiation.</li> <li>• the system is outside the operating temperature range.</li> <li>• the on-board voltage is too low.</li> </ul> <p>When the causes stated above no longer apply, the display message disappears.</p> <p>PRE-SAFE® PLUS and PRE-SAFE® Brake are operational again.</p> <p>If the display message does not disappear:</p> <ul style="list-style-type: none"> <li>► Pull over and stop the vehicle safely as soon as possible, paying attention to road and traffic conditions.</li> <li>► Secure the vehicle against rolling away (▷ page 189).</li> <li>► Restart the engine.</li> </ul>
<p>PRE-SAFE Functions Limited See Operator's Manual</p>	<p>PRE-SAFE® PLUS or PRE-SAFE® Brake is unavailable due to a malfunction. BAS PLUS with Cross-Traffic Assist may also have failed.</p> <ul style="list-style-type: none"> <li>► Visit a qualified specialist workshop immediately.</li> </ul>

Display messages	Possible causes/consequences and ► Solutions
<p>Radar Sensors Dirty See Operator's Manual</p>	<p>At least one of the following driving systems or driving safety systems is temporarily restricted or inoperative:</p> <ul style="list-style-type: none"> <li>• PRE-SAFE® PLUS</li> <li>• PRE-SAFE® Brake</li> <li>• COLLISION PREVENTION ASSIST PLUS</li> <li>• Active Lane Keeping Assist</li> <li>• Active Blind Spot Assist</li> <li>• DISTRONIC PLUS with Steering Assist and Stop&amp;Go Pilot</li> </ul> <p>If the radar sensor system in front is dirty, Active Blind Spot Assist will not perform a course-correcting brake application.</p> <p>Possible causes are:</p> <ul style="list-style-type: none"> <li>• the sensors in the radiator trim and/or in the bumpers are dirty</li> <li>• the function of the driving system and/or driving safety system is impaired due to heavy rain or snow.</li> </ul> <p>A warning tone also sounds.</p> <p>When the causes stated above no longer apply, the display message disappears. All driving systems and driving safety systems are operative again.</p> <p>If the display message does not disappear:</p> <ul style="list-style-type: none"> <li>► Pull over and stop the vehicle safely as soon as possible, paying attention to road and traffic conditions.</li> <li>► Secure the vehicle against rolling away (▷ page 189).</li> <li>► Switch off the engine.</li> <li>► Clean the sensors in the following locations (▷ page 362): <ul style="list-style-type: none"> <li>• in the radiator trim</li> <li>• in the front bumper</li> <li>• in the rear bumper, particularly in the middle of the rear bumper</li> </ul> </li> <li>► Restart the engine.</li> </ul> <p>The display message disappears.</p>
<p>Check Left Rear Belt See Operator's Manual or Check Right Rear Belt See Operator's Manual</p>	<p>The seat belt buckle extender on the right or left of the rear compartment is not in the predefined position. The belt strap may be jammed in the belt tongue.</p> <p> <b>WARNING</b></p> <p>If the seat belt buckle extender is not in the predefined position, the seat belt cannot provide the intended level of protection.</p> <p>There is an increased risk of injury.</p> <ul style="list-style-type: none"> <li>► Pull over and stop the vehicle safely as soon as possible, paying attention to road and traffic conditions.</li> <li>► Release the jamming.</li> <li>► Repeat the seat belt fastening procedure.</li> </ul>

Display messages	Possible causes/consequences and ► Solutions
	<p>The seat belt buckle extender on the right or left of the rear compartment is not in the predefined position. The seat belt buckle extender may be jammed.</p> <p> <b>WARNING</b></p> <p>If the seat belt buckle extender is not in the predefined position, the seat belt cannot provide the intended level of protection. There is an increased risk of injury.</p> <ul style="list-style-type: none"> <li>► Move the seat cushion forwards (&gt; page 107) and remove the cause of the jam.</li> <li>► Repeat the seat belt fastening procedure.</li> </ul>
	<p>The seat belt buckle extender on the right or left of the rear compartment is not in the predefined position. The seat belt may be locked.</p> <p> <b>WARNING</b></p> <p>If the seat belt buckle extender is not in the predefined position, the seat belt cannot provide the intended level of protection. There is an increased risk of injury.</p> <ul style="list-style-type: none"> <li>► Completely take off your seat belt.</li> <li>► Repeat the seat belt fastening procedure.</li> </ul>
	<p>The seat belt buckle extender on the right or left of the rear compartment is not in the predefined position. There is not enough belt slack in the system.</p> <p> <b>WARNING</b></p> <p>If the seat belt buckle extender is not in the predefined position, the seat belt cannot provide the intended level of protection. There is an increased risk of injury.</p> <ul style="list-style-type: none"> <li>► Loosen the seat belt.</li> <li>► Repeat the seat belt fastening procedure.</li> </ul>
	<p>The seat belt buckle extender on the right or left of the rear compartment is not in the predefined position. The assistance measures specified have been carried out. There is still a malfunction.</p> <p> <b>WARNING</b></p> <p>If the seat belt buckle extender is not in the predefined position, the seat belt cannot provide the intended level of protection. There is an increased risk of injury.</p> <ul style="list-style-type: none"> <li>► Visit a qualified specialist workshop immediately.</li> </ul>



Display messages	Possible causes/consequences and ► Solutions
 <p>SRS Malfunction Service Required</p>	<p>The restraint system is faulty. The  warning lamp also lights up in the instrument cluster.</p> <p><b>▲ WARNING</b></p> <p>The air bags or Emergency Tensioning Devices may either be triggered unintentionally or, in the event of an accident, may not be triggered. There is an increased risk of injury.</p> <p>► Visit a qualified specialist workshop immediately.</p> <p>For further information about the restraint system, see (► page 44).</p>
 <p>Front Left Malfunction Service Required or Front Right Malfunction Service Required</p>	<p>The restraint system has malfunctioned at the front on the left or right. The  warning lamp also lights up in the instrument cluster.</p> <p><b>▲ WARNING</b></p> <p>The air bags or Emergency Tensioning Devices may either be triggered unintentionally or, in the event of an accident, may not be triggered. There is an increased risk of injury.</p> <p>► Visit a qualified specialist workshop immediately.</p>
 <p>Rear Left Malfunction Service Required or Rear Right Malfunction Service Required</p>	<p>The restraint system has malfunctioned at the rear on the left or right. The  warning lamp also lights up in the instrument cluster.</p> <p><b>▲ WARNING</b></p> <p>The air bags or Emergency Tensioning Devices may either be triggered unintentionally or, in the event of an accident, may not be triggered. There is an increased risk of injury.</p> <p>► Visit a qualified specialist workshop immediately.</p>
 <p>Rear Left Malfunction Service Required or Rear Right Malfunction Service Required</p>	<p><b>▲ WARNING</b></p> <p>If the seat belt buckle extender is not in the predefined position, the seat belt cannot provide the intended level of protection. There is an increased risk of injury.</p> <p>► Pull over and stop the vehicle safely as soon as possible, paying attention to road and traffic conditions.</p> <p>► Perform the specified assistance measures when display message <b>Check Left Rear Belt See Operator's Manual</b> or <b>Check Right Rear Belt See Operator's Manual</b> is shown (► page 285).</p> <p>If the display message does not disappear:</p> <p>► Visit a qualified specialist workshop immediately.</p>

Display messages	Possible causes/consequences and ► Solutions
 <p>Rear Center Malfunction Service Required</p>	<p>The restraint system has malfunctioned at the rear center. The  warning lamp also lights up in the instrument cluster.</p> <p> <b>WARNING</b></p> <p>The air bags or Emergency Tensioning Devices may either be triggered unintentionally or, in the event of an accident, may not be triggered. There is an increased risk of injury.</p> <p>► Visit a qualified specialist workshop immediately.</p>
 <p>Left Side Curtain Airbag Malfunction Service Required or Right Side Curtain Airbag Malfunction Service Required</p>	<p>There is a malfunction in the left-hand or right-hand window curtain air bag. The  warning lamp also lights up in the instrument cluster.</p> <p> <b>WARNING</b></p> <p>The left or right window curtain air bag may either be triggered unintentionally or, in the event of an accident, may not be triggered. There is an increased risk of injury.</p> <p>► Visit a qualified specialist workshop immediately.</p>

Display messages	Possible causes/consequences and ► Solutions
<p>Front Passenger Airbag Disabled See Operator's Manual</p>	<p>The front-passenger air bag is deactivated during the journey, even though:</p> <ul style="list-style-type: none"> <li>• an adult or</li> <li>• a person of the corresponding stature is on the front-passenger seat</li> </ul> <p>If additional forces are applied to the seat, the system may interpret the occupant's weight as lower than it actually is.</p> <p> <b>WARNING</b></p> <p>The front-passenger air bag does not deploy during an accident. There is an increased risk of injury.</p> <ul style="list-style-type: none"> <li>► Pull over and stop the vehicle safely as soon as possible, paying attention to road and traffic conditions.</li> <li>► Secure the vehicle against rolling away (► page 189).</li> <li>► Switch the ignition off.</li> <li>► Have the occupant get out of the vehicle.</li> <li>► Keep the seat unoccupied, close the front-passenger door and switch on the ignition.</li> <li>► Observe the PASSENGER AIR BAG indicator lamps in the center console and the multifunction display and check the following: <ul style="list-style-type: none"> <li>Seat unoccupied and ignition switched on: <ul style="list-style-type: none"> <li>• a self-diagnosis is carried out. The PASSENGER AIR BAG OFF and PASSENGER AIR BAG ON indicator lamps must light up simultaneously for approximately six seconds</li> <li>• the PASSENGER AIR BAG OFF indicator lamp must then light up and remain lit after the self-diagnosis. If the indicator lamp is on, OCS has disabled the front-passenger front air bag (► page 54)</li> <li>• the display messages <a href="#">Front Passenger Airbag Enabled See Operator's Manual</a> or <a href="#">Front Passenger Airbag Disabled See Operator's Manual</a> must not appear in the multifunction display.</li> </ul> </li> </ul> </li> <li>► Wait for a period of at least 60 seconds until the necessary system checks have been completed.</li> <li>► Make sure that the display messages do not appear in the multifunction display.</li> </ul> <p>If these conditions are fulfilled, the front-passenger seat can be occupied again. Whether the PASSENGER AIR BAG OFF or ON indicator lamp remains lit or goes out depends on how OCS classifies the occupant.</p> <p>If the conditions are not fulfilled, the system is not operating correctly.</p> <ul style="list-style-type: none"> <li>► Visit a qualified specialist workshop immediately.</li> </ul> <p>For further information about the Occupant Classification System, see (► page 54).</p>







Display messages	Possible causes/consequences and ► Solutions
<p>Front Passenger Air-bag Enabled See Operator's Manual</p>	<p>The front-passenger air bag is enabled during the journey, even though:</p> <ul style="list-style-type: none"> <li>• a child, a small adult or an object weighing less than the system's weight threshold is located on the front-passenger seat or</li> <li>• the front-passenger seat is unoccupied</li> </ul> <p>The system may detect objects or forces applying additional weight on the seat.</p> <p> <b>WARNING</b></p> <p>The air bag may deploy unintentionally. There is an increased risk of injury.</p> <ul style="list-style-type: none"> <li>► Pull over and stop the vehicle safely as soon as possible, paying attention to road and traffic conditions.</li> <li>► Secure the vehicle against rolling away (► page 189).</li> <li>► Switch the ignition off.</li> <li>► Open the front-passenger door.</li> <li>► Remove the child and the child restraint system from the front-passenger seat.</li> <li>► Make sure that there are no objects on the seat adding to the weight. The system may otherwise detect the additional weight and interpret the seat occupant's weight as greater than it actually is.</li> <li>► Keep the seat unoccupied, close the front-passenger door and switch on the ignition.</li> <li>► Observe the PASSENGER AIR BAG indicator lamps in the center console and the multifunction display and check the following: Seat unoccupied and ignition switched on: <ul style="list-style-type: none"> <li>• a self-diagnosis is carried out. The PASSENGER AIR BAG OFF and PASSENGER AIR BAG ON indicator lamps light up simultaneously for approximately six seconds</li> <li>• the PASSENGER AIR BAG OFF indicator lamp must then light up and remain lit after the self-diagnosis. If the indicator lamp is on, OCS (Occupant Classification System) has disabled the front-passenger front air bag (► page 54)</li> <li>• the display messages <a href="#">Front Passenger Airbag Enabled See Operator's Manual</a> or <a href="#">Front Passenger Airbag Disabled See Operator's Manual</a> must not appear in the multifunction display.</li> </ul> </li> <li>► Wait for a period of at least 60 seconds until the necessary system checks have been completed.</li> <li>► Make sure that the display messages do not appear in the multifunction display.</li> </ul> <p>If these conditions are fulfilled, the front-passenger seat can be occupied again. Whether the PASSENGER AIR BAG OFF or ON indicator lamp remains lit or goes out depends on how OCS classifies the occupant.</p> <p>If the conditions are not fulfilled, the system is not operating correctly.</p>









Display messages	Possible causes/consequences and ► Solutions
	<p>► Visit a qualified specialist workshop immediately.</p> <p>For further information about the Occupant Classification System, see (► page 54).</p>









## Lights

**i** Vehicles with LED bulbs in the light clusters:

The display message for the corresponding lamp only appears when all of the LEDs in the lamp have failed.

Display messages	Possible causes/consequences and ► Solutions
 <p>Check Left Cornering Light or Check Right Cornering Light</p>	<p>The left or right-hand cornering light is defective.</p> <p>► Visit a qualified specialist workshop.</p>
 <p>Check Left Low Beam or Check Right Low Beam</p>	<p>The left or right-hand low-beam headlamp is defective.</p> <p>► Visit a qualified specialist workshop.</p>
 <p>Check Rear Left Turn Signal or Check Rear Right Turn Signal</p>	<p>The rear left-hand or rear right-hand turn signal is defective.</p> <p>► Visit a qualified specialist workshop.</p>
 <p>Check Front Left Turn Signal or Check Front Right Turn Signal</p>	<p>The front left-hand or front right-hand turn signal is defective.</p> <p>► Visit a qualified specialist workshop.</p>
 <p>Check Left Mirror Turn Signal or Check Right Mirror Turn Signal</p>	<p>The turn signal in the left-hand or right-hand exterior mirror is defective.</p> <p>► Visit a qualified specialist workshop.</p>
 <p>Check Left Brake Lamp or Check Right Brake Lamp</p>	<p>The left or right-hand brake lamp is defective.</p> <p>► Visit a qualified specialist workshop.</p>

Display messages	Possible causes/consequences and ► Solutions
 <p>Check Center Brake Lamp</p>	<p>The high-mounted brake lamp is faulty. ► Visit a qualified specialist workshop.</p>
 <p>Check Left Tail and Brake Lamps or Check Right Tail and Brake Lamps</p>	<p>The left or right-hand tail lamp/brake lamp is defective. ► Visit a qualified specialist workshop.</p>
 <p>Check Left Tail Lamp or Check Right Tail Lamp</p>	<p>The left or right-hand tail lamp is defective. ► Visit a qualified specialist workshop.</p>
 <p>Check Left High Beam or Check Right High Beam</p>	<p>The left or right-hand high beam is defective. ► Visit a qualified specialist workshop.</p>
 <p>License Plate Lamp</p>	<p>The left or right-hand license plate lamp is faulty. ► Visit a qualified specialist workshop.</p>
 <p>Check Front Left Parking Lamp or Check Front Right Parking Lamp</p>	<p>The front left or front right parking or standing lamp is defective. ► Visit a qualified specialist workshop.</p>
 <p>Backup Light</p>	<p>The left or right-hand backup lamp is defective. ► Visit a qualified specialist workshop.</p>
 <p>Check Front Left Sidemarkers Lamp or Check Front Right Sidemarkers Lamp</p>	<p>The front left-hand or front right-hand side marker lamp is faulty. ► Visit a qualified specialist workshop.</p>
 <p>Check Rear Left Sidemarkers Lamp or Check Rear Right Sidemarkers Lamp</p>	<p>The rear left-hand or rear right-hand side marker lamp is faulty. ► Visit a qualified specialist workshop.</p>

Display messages	Possible causes/consequences and ► Solutions
 <p>Check Left Daytime Running Light or Check Right Daytime Running Light</p>	<p>The left or right-hand daytime running lamp is faulty.</p> <p>► Visit a qualified specialist workshop.</p>
 <p>Active Headlamps Inoperative</p>	<p>The active light function is faulty.</p> <p>► Visit a qualified specialist workshop.</p>
 <p>Malfunction See Operator's Manual</p>	<p>The exterior lighting is defective.</p> <p>► Visit a qualified specialist workshop.</p>
 <p>Auto Lamp Function Inoperative</p>	<p>The light sensor is defective.</p> <p>► Visit a qualified specialist workshop.</p>
 <p>Switch Off Lights</p>	<p>You leave the vehicle and the lights are switched on. A warning tone also sounds.</p> <p>► Turn the light switch to position .</p>
 <p>Switch On Headlamps</p>	<p>You are driving with low-beam headlamps switched off.</p> <p>► Turn the light switch to position  or .</p>
<p>Adaptive Highbeam Assist Plus Inoperative</p>	<p>Adaptive Highbeam Assist Plus is faulty.</p> <p>► Visit a qualified specialist workshop.</p>
<p>Adaptive Highbeam Assist Plus Currently Unavailable See Operator's Manual</p>	<p>Adaptive Highbeam Assist Plus is deactivated and temporarily inoperative.</p> <p>Possible causes are:</p> <ul style="list-style-type: none"> <li>• the windshield in the camera's field of vision is dirty.</li> <li>• visibility is impaired due to heavy rain, snow or fog.</li> </ul> <p>► Clean the windshield.</p> <p>If the system detects that the camera is fully operational again, the <b>Adaptive Highbeam Assist Plus Available Again</b> message is displayed.</p> <p>Adaptive Highbeam Assist Plus is operational again.</p>

## Engine

## Display messages

## Possible causes/consequences and ► Solutions



Check Coolant Level  
See Operator's Manual

The coolant level is too low.

❗ Avoid making long journeys with too little coolant in the engine cooling system. The engine will otherwise be damaged.

► Add coolant, observing the warning notes before doing so (► page 356).

**If you have to add coolant frequently:**

► Contact a qualified specialist workshop and have the engine cooling system checked.



The fan motor is faulty.

► At coolant temperatures below 257 °F (125 °C), drive to the nearest qualified specialist workshop.

► Avoid heavy loads on the engine as you do so, e.g. driving in mountainous terrain and stop-start traffic.



Coolant Too Hot  
Stop Vehicle Turn  
Engine Off

The coolant is too hot.

A warning tone also sounds.

⚠ **WARNING**

Do not drive when your engine is overheated. This can cause some fluids which may have leaked into the engine compartment to catch fire.

Steam from the overheated engine can also cause serious burns which can occur just by opening the hood.

There is a risk of injury.

► Pull over and stop the vehicle safely and switch off the engine, paying attention to road and traffic conditions.

► Secure the vehicle against rolling away (► page 189).

► Wait until the engine has cooled down.

► Make sure that the air supply to the engine radiator is not blocked, e.g. by snow, slush or ice.

► Do not start the engine again until the display message goes out and the coolant temperature is below 257 °F (125 °C). Otherwise, the engine could be damaged.





► Pay attention to the coolant temperature display.







**If the temperature increases again:**

► Visit a qualified specialist workshop immediately.





Under normal operating conditions and with the specified coolant level, the coolant temperature may rise to 255 °F (124 °C).







Display messages	Possible causes/consequences and ► Solutions
 <p data-bbox="116 220 347 268">See Operator's Manual</p>	<p data-bbox="372 172 692 197">The battery is not being charged.</p> <p data-bbox="372 204 645 229">A warning tone also sounds.</p> <p data-bbox="372 236 568 261">Possible causes are:</p> <ul data-bbox="372 268 927 389" style="list-style-type: none"> <li data-bbox="372 268 602 293">• a defective alternator</li> <li data-bbox="372 300 927 325">• defective power electronics (PLUG-IN HYBRID vehicles)</li> <li data-bbox="372 331 564 357">• a torn poly-V-belt</li> <li data-bbox="372 363 698 389">• a malfunction in the electronics</li> </ul> <p data-bbox="372 402 1009 427"><b>!</b> Do not continue driving. The engine could otherwise overheat.</p> <ul data-bbox="372 434 1033 555" style="list-style-type: none"> <li data-bbox="372 434 1033 491">► Pull over and stop the vehicle safely and switch off the engine, paying attention to road and traffic conditions.</li> <li data-bbox="372 497 908 523">► Secure the vehicle against rolling away (▷ page 189).</li> <li data-bbox="372 529 777 555">► Consult a qualified specialist workshop.</li> </ul>
 <p data-bbox="116 627 320 675">Stop Vehicle See Operator's Manual</p>	<p data-bbox="372 579 1033 627">The battery is no longer being charged and the battery charge level is too low.</p> <p data-bbox="372 633 645 659">A warning tone also sounds.</p> <ul data-bbox="372 665 1033 841" style="list-style-type: none"> <li data-bbox="372 665 1033 722">► Pull over and stop the vehicle safely and switch off the engine, paying attention to road and traffic conditions.</li> <li data-bbox="372 729 908 754">► Secure the vehicle against rolling away (▷ page 189).</li> <li data-bbox="372 761 1005 809">► Observe the instructions in the  See Operator's Manual display message.</li> <li data-bbox="372 815 777 841">► Consult a qualified specialist workshop.</li> </ul>
 <p data-bbox="116 906 336 962">Stop Vehicle Leave Engine Running</p>	<p data-bbox="372 858 710 884">The battery charge level is too low.</p> <ul data-bbox="372 890 1012 1034" style="list-style-type: none"> <li data-bbox="372 890 1012 970">► Pull over and stop the vehicle safely as soon as possible, paying attention to road and traffic conditions. Do not continue driving under any circumstances.</li> <li data-bbox="372 976 645 1002">► Leave the engine running.</li> <li data-bbox="372 1008 1001 1034">► Wait until the display message disappears before pulling away.</li> </ul>
 <p data-bbox="116 1101 320 1157">Start Engine See Operator's Manual</p>	<p data-bbox="372 1053 1005 1078">The engine is switched off and the battery charge level is too low.</p> <ul data-bbox="372 1085 1033 1197" style="list-style-type: none"> <li data-bbox="372 1085 1033 1142">► Switch off electrical consumers that you do not need, such as the rear window defroster and interior lighting.</li> <li data-bbox="372 1149 1033 1197">► Leave the engine running for a few minutes or drive a long distance. The battery is being charged.</li> </ul>



Display messages	Possible causes/consequences and ► Solutions
 <p>Check Engine Oil At Next Refueling</p>	<p>The engine oil level has dropped to the minimum level. A warning tone also sounds.</p> <ul style="list-style-type: none"> <li>❗ Avoid long journeys with too little engine oil. The engine will otherwise be damaged.</li> <li>► Check the oil level when next refueling, at the latest (▷ page 353).</li> <li>► If necessary, add engine oil (▷ page 355).</li> </ul> <p><b>If the engine oil needs topping up more often:</b></p> <ul style="list-style-type: none"> <li>► Contact a qualified specialist workshop and have the engine checked.</li> </ul> <p>Information on approved engine oils can be obtained from any qualified specialist workshop or on the Internet at <a href="http://bevo.mercedes-benz.com">http://bevo.mercedes-benz.com</a>.</p>
 <p>Check Engine Oil Level (Add 1 quart)</p>	<p>The engine oil level has dropped to the minimum level.</p> <ul style="list-style-type: none"> <li>❗ Avoid long journeys with too little engine oil. The engine will otherwise be damaged.</li> <li>► Check the oil level when next refueling, at the latest (▷ page 353).</li> <li>► If necessary, add engine oil (▷ page 355).</li> </ul> <p><b>If the engine oil needs topping up more often:</b></p> <ul style="list-style-type: none"> <li>► Contact a qualified specialist workshop and have the engine checked.</li> </ul> <p>Information on approved engine oils can be obtained from any qualified specialist workshop or on the Internet at <a href="http://bevo.mercedes-benz.com">http://bevo.mercedes-benz.com</a>.</p>
 <p>Engine Oil Level Low Stop Vehicle Turn Engine Off</p>	<p>The engine oil level is too low. There is a risk of engine damage.</p> <ul style="list-style-type: none"> <li>► Pull over and stop the vehicle safely and switch off the engine, paying attention to road and traffic conditions.</li> <li>► Secure the vehicle against rolling away (▷ page 189).</li> <li>► Check the engine oil level (▷ page 353).</li> <li>► If necessary, add engine oil (▷ page 355).</li> </ul>
 <p>Fuel Level Low</p>	<p>The fuel level has dropped into the reserve range.</p> <ul style="list-style-type: none"> <li>► Refuel at the nearest gas station.</li> </ul>
	<p>There is only a very small amount of fuel in the fuel tank.</p> <ul style="list-style-type: none"> <li>► Refuel at the nearest gas station without fail.</li> </ul>
 <p>Gas Cap Loose</p>	<p>The fuel filler cap is not closed correctly or the fuel system is leaking.</p> <ul style="list-style-type: none"> <li>► Check that the fuel filler cap is correctly closed.</li> </ul> <p><b>If the fuel filler cap is not correctly closed:</b></p> <ul style="list-style-type: none"> <li>► Close the fuel filler cap.</li> </ul> <p><b>If the fuel filler cap is correctly closed:</b></p> <ul style="list-style-type: none"> <li>► Visit a qualified specialist workshop.</li> </ul>



Hybrid drive system	
Display messages	Possible causes/consequences and ► Solutions
 <p>Vehicle Operational Switch the Ignition Off Before Exiting</p>	<p>PLUG-IN HYBRID vehicles:</p> <p>You are leaving the vehicle when it is in a ready-to-drive state. The READY indicator in the multifunction display is on. A warning tone also sounds.</p> <p>If you leave the vehicle:</p> <ul style="list-style-type: none"> <li>► Secure the vehicle against rolling away (▷ page 189).</li> <li>► Switch off the ignition and remove the SmartKey.</li> </ul> <p>If you do not leave the vehicle:</p> <ul style="list-style-type: none"> <li>► Switch off the electrical consumers, e.g. automatic climate control, seat heating.</li> </ul> <p>Please note the following: the electrical consumers are supplied by the 12 V battery. If the vehicle is left in a ready-to-drive state for an extended period, it will switch off once the 12 V battery is almost empty. It will then only be possible to start the vehicle using a second battery (jump-starting).</p>
<p>Change the current drive program before changing the operating mode. or Exit manual drive program M before changing the operating mode.</p>	<p>PLUG-IN HYBRID vehicles:</p> <p>You have attempted to change the operating mode when in automatic drive program <b>S</b> (Sport) or manual drive program <b>M</b>.</p> <ul style="list-style-type: none"> <li>► Activate the drive program <b>E</b> (Economy) or <b>E+</b> (Economy Plus) (▷ page 250).</li> <li>► Select the preferred operating mode <b>HYBRID</b>, <b>E-MODE</b>, <b>E-SAVE</b> or <b>CHARGE</b> (▷ page 243).</li> </ul>
<p>E-MODE Currently Unavailable</p>	<p>PLUG-IN HYBRID vehicles:</p> <p>The condition of charge of the high-voltage battery has dropped to the lower limit and the <b>E-MODE</b> operating mode has been switched off. Driving with the internal combustion engine is activated and the operating mode switches to the basic <b>HYBRID</b> setting.</p> <ul style="list-style-type: none"> <li>► Continue driving using the internal combustion engine. You can switch to the <b>E-SAVE</b> or <b>CHARGE</b> operating mode as required (▷ page 243).</li> </ul> <p>If you select <b>CHARGE</b>, the high-voltage battery is charged. Once the charge level display for the high-voltage battery has increased slightly, you can switch to the <b>E-MODE</b> operating mode again.</p>

Display messages	Possible causes/consequences and ► Solutions
<p>Only E-MODE Available Power Limited Refuel Immediately</p>	<p>PLUG-IN HYBRID vehicles:</p> <p>The fuel tank has been run dry and the combustion engine has been switched off.</p> <p>A warning tone also sounds.</p> <p>The vehicle will be powered by electrical energy only. Performance is restricted and the vehicle may accelerate more slowly than normal.</p> <p>► Refuel at the nearest gas station without fail.</p> <p>In the "Total range and electric range" menu, you can display the approximate range of the vehicle (▷ page 248).</p>
<p>Engine will not restart Service required</p>	<p>You cannot start the engine again due to a malfunction.</p> <p>A warning tone also sounds.</p> <p>If the engine is running:</p> <p>► Visit a qualified specialist workshop.</p> <p>If you switch off the engine:</p> <p>► Secure the vehicle against rolling away (▷ page 189).</p> <p>► Notify a qualified specialist workshop or breakdown service.</p>
 <p>Towing Not Permitted See Operator's Manual</p>	<p>The hybrid drive system is faulty.</p> <p>► Have the vehicle transported on a transporter or trailer to the nearest qualified specialist workshop.</p>
 <p>Malfunction Service Required</p>	<p>The hybrid drive system is faulty.</p> <p>► Visit a qualified specialist workshop.</p>
 <p>Malfunction</p>	<p>The hybrid drive system is faulty.</p> <p>► Have the vehicle towed away by a professional recovery company to the nearest qualified specialist workshop.</p>
 <p>Malfunction</p>	<p>The hybrid drive system is faulty.</p> <p>The ECO start/stop function may be malfunctioning.</p> <p>The drive power is restricted.</p> <p>► Visit a qualified specialist workshop.</p>
 <p>Charger Cable Connected</p>	<p>PLUG-IN HYBRID vehicles:</p> <p>The charging cable connector is connected to the vehicle socket. You cannot drive off as long as the charging cable connector is still connected.</p> <p>Before you drive off:</p> <p>► Remove the charging cable connector from the vehicle socket (▷ page 185).</p>

Display messages	Possible causes/consequences and ► Solutions
 <p>Please Wait Depressurizing Tank</p>	<p>PLUG-IN HYBRID vehicles:</p> <p>The fuel filler flap unlocking button has been pulled. The fuel tank must be depressurized before refueling.</p> <ul style="list-style-type: none"> <li>► Wait until the fuel tank is depressurized and the fuel filler flap is unlocked. The opening process for the fuel filler cap may take up to 15 minutes.</li> </ul>
 <p>Tank is Depressurized Ready for Refueling</p>	<p>PLUG-IN HYBRID vehicles:</p> <p>The fuel tank is now depressurized. The vehicle may now be refueled.</p> <ul style="list-style-type: none"> <li>► Observe the information on refueling on the fuel filler flap.</li> <li>► Open the fuel filler cap and remove it (▷ page 179).</li> </ul>
 <p>Tank Ventilation Malfunction Service Required</p>	<p>PLUG-IN HYBRID vehicles:</p> <p>There is a malfunction in the fuel system.</p> <ul style="list-style-type: none"> <li>► Visit a qualified specialist workshop.</li> </ul>
 <p>Acoustic Vehicle Indication Inoperative</p>	<p>PLUG-IN HYBRID vehicles:</p> <p>The sound generator is not working. The vehicle can still be driven; however, no vehicle sounds can be generated. As a result, your vehicle may not be heard by other road users until it is very close to them, or it may not be heard at all.</p> <ul style="list-style-type: none"> <li>► Drive with particular care, allowing for the possibility that other road users may behave unpredictably.</li> <li>► Visit a qualified specialist workshop.</li> </ul>

## Driving systems

Display messages	Possible causes/consequences and ► Solutions
 <p>ATTENTION ASSIST: Take a Break!</p>	<p>Based on certain criteria, ATTENTION ASSIST has detected fatigue or a lack of concentration on the part of the driver. A warning tone also sounds.</p> <ul style="list-style-type: none"> <li>► If necessary, take a break.</li> </ul> <p>During long journeys, take regular breaks in good time so you get enough rest.</p>
 <p>ATTENTION ASSIST Inoperative</p>	<p>ATTENTION ASSIST is inoperative.</p> <ul style="list-style-type: none"> <li>► Visit a qualified specialist workshop.</li> </ul>
 <p>Vehicle Rising</p>	<p>Your vehicle is adjusting to the level you have selected.</p>

Display messages	Possible causes/consequences and ► Solutions
 <p>Vehicle Rising Please Wait</p>	<p>The vehicle level is too low when the vehicle is stationary. A warning tone also sounds.</p> <ul style="list-style-type: none"> <li>► Do not pull away. The vehicle level is set when the display message disappears.</li> </ul>
 <p>Stop Vehicle Vehicle Too Low</p>	<p>You have pulled away while the vehicle level is still too low. AIRMATIC sets the vehicle to the selected level after a short period.</p> <ul style="list-style-type: none"> <li>► Pull over and stop the vehicle safely as soon as possible, paying attention to road and traffic conditions.</li> <li>► Secure the vehicle against rolling away (▷ page 189).</li> <li>► Wait until the display message disappears before pulling away.</li> </ul> <p>AIRMATIC is defective. A warning tone also sounds.</p> <ul style="list-style-type: none"> <li>► Do not drive at speeds above 50 mph (80 km/h).</li> <li>► Make only slight steering movements. Otherwise, the front fender or the tires could be damaged if the steering movement is too large.</li> <li>► Listen for scraping sounds.</li> <li>► Pull over and stop the vehicle safely, paying attention to road and traffic conditions, and set a higher vehicle level. Depending on the malfunction, it may be possible to raise the vehicle.</li> <li>► Visit a qualified specialist workshop.</li> </ul>
 <p>Malfunction</p>	<p>The AIRMATIC function is restricted. The vehicle's handling characteristics may be affected.</p> <ul style="list-style-type: none"> <li>► Do not drive at speeds above 50 mph (80 km/h).</li> <li>► Visit a qualified specialist workshop.</li> </ul>
<p>ABC Malfunction Stop Vehicle</p>	<p>The Active Body Control (ABC) vehicle level is too low.</p> <ul style="list-style-type: none"> <li>► Pull over and stop the vehicle safely as soon as possible, paying attention to road and traffic conditions. After a few seconds, the vehicle level is adjusted and the display message disappears.</li> </ul> <p>The multifunction display continuously shows the display message. The vehicle is leaking oil.</p> <ul style="list-style-type: none"> <li>► Pull over and stop the vehicle safely as soon as possible, paying attention to road and traffic conditions. Do not continue driving under any circumstances.</li> <li>► Consult a qualified specialist workshop.</li> </ul> <p>The multifunction display continuously shows the display message. Active Body Control (ABC) is malfunctioning.</p> <ul style="list-style-type: none"> <li>► Do not drive at speeds above 50 mph (80 km/h).</li> <li>► Make only slight steering movements. Otherwise, the front fender or the tires could be damaged if the steering movement is too large.</li> <li>► Listen for scraping sounds.</li> <li>► Visit a qualified specialist workshop.</li> </ul>

Display messages	Possible causes/consequences and ► Solutions
ABC Vehicle Rising Please Wait Briefly	<p>The vehicle level is too low when the vehicle is stationary. A warning tone also sounds.</p> <ul style="list-style-type: none"> <li>► Do not pull away. The vehicle level is set when the display message disappears.</li> </ul>
ABC Malfunction	<p>The Active Body Control (ABC) function is restricted. The vehicle's handling characteristics may be affected.</p> <ul style="list-style-type: none"> <li>► Do not drive at speeds above 50 mph (80 km/h).</li> <li>► Visit a qualified specialist workshop.</li> </ul>
Active Lane Keeping Assist Currently Unavailable See Operator's Manual	<p>Active Lane Keeping Assist is deactivated and temporarily inoperative. Possible causes are:</p> <ul style="list-style-type: none"> <li>• the windshield in the camera's field of vision is dirty.</li> <li>• visibility is impaired due to heavy rain, snow or fog.</li> <li>• there have been no lane markings for an extended period.</li> <li>• the lane markings are worn, dark or covered, e.g. by dirt or snow.</li> </ul> <p>When the causes stated above no longer apply, the display message disappears.</p> <p>Active Lane Keeping Assist is operational again.</p> <p>If the display message does not disappear:</p> <ul style="list-style-type: none"> <li>► Pull over and stop the vehicle safely as soon as possible, paying attention to road and traffic conditions.</li> <li>► Secure the vehicle against rolling away (▷ page 189).</li> <li>► Clean the windshield.</li> </ul>
Active Lane Keeping Assist Inoperative	<p>Active Lane Keeping Assist is defective.</p> <ul style="list-style-type: none"> <li>► Visit a qualified specialist workshop.</li> </ul>
Active Blind Spot Assist Currently Unavailable See Operator's Manual	<p>Active Blind Spot Assist is temporarily inoperative. Possible causes are:</p> <ul style="list-style-type: none"> <li>• the radar sensor system is outside the operating temperature range.</li> <li>• the radar sensor system is temporarily inoperative, e.g. due to electromagnetic radiation emitted by nearby TV or radio stations or other sources of electromagnetic radiation.</li> </ul> <p>When the causes stated above no longer apply, the display message disappears.</p> <p>Active Blind Spot Assist is operational again.</p> <p>If the display message does not disappear:</p> <ul style="list-style-type: none"> <li>► Pull over and stop the vehicle safely as soon as possible, paying attention to road and traffic conditions.</li> <li>► Secure the vehicle against rolling away (▷ page 189).</li> <li>► Restart the engine.</li> </ul>
Active Blind Spot Assist Inoperative	<p>Active Blind Spot Assist is defective.</p> <ul style="list-style-type: none"> <li>► Visit a qualified specialist workshop.</li> </ul>

Display messages	Possible causes/consequences and ► Solutions
Park Assist Canceled	The driver's door is open. ► Repeat the parking gap measurement and parking process with the driver's door closed.
	You touched the multifunction steering wheel while steering intervention was active. ► While steering intervention is active, make sure that the multifunction steering wheel is not touched unintentionally.
	The vehicle has started to skid and ESP® has intervened. ► Use Active Parking Assist again later (▷ page 216).
Park Assist Inoperative	PARKTRONIC is malfunctioning or faulty. ► Follow the instructions and helpful hints in the "Problems with PARKTRONIC" section (▷ page 216).  If the multifunction display still shows the display message: ► Visit a qualified specialist workshop.
	Active Parking Assist is unavailable or faulty. ► Switch off the ignition and restart the engine.  If Active Parking Assist continues to be unavailable (the <b>P</b> symbol is not shown in the multifunction display): ► Visit a qualified specialist workshop.
Park Assist Switched Off	The vehicle is parked. A warning tone also sounds. The display message disappears automatically.
Night View Assist Currently Unavailable	Night View Assist Plus is deactivated and temporarily inoperative. Possible causes are: <ul style="list-style-type: none"> <li>• the windshield in the camera's field of vision is dirty.</li> <li>• the camera in the radiator trim is dirty.</li> <li>• visibility is impaired due to heavy rain, snow or fog.</li> <li>• the outside temperature is too high.</li> </ul> ► Clean the windshield. ► Clean the camera in the radiator trim.  If the system has been switched off due to excessive outside temperatures, the system will switch back on automatically once it has cooled down.  If the system detects that the camera is fully operational, the display message disappears.  Night View Assist Plus is operational again.
Night View Assist Inoperative	Night View Assist Plus is defective. ► Visit a qualified specialist workshop.





Display messages	Possible causes/consequences and ► Solutions
<b>Spotlight Inoperative</b>	<p>Night View Assist Plus is deactivated and temporarily inoperative. Possible causes are:</p> <ul style="list-style-type: none"> <li>• the windshield in the camera's field of vision is dirty.</li> <li>• the camera in the radiator trim is dirty.</li> <li>• visibility is impaired due to heavy rain, snow or fog.</li> <li>• the outside temperature is too high.</li> </ul> <p>► Clean the windshield. ► Clean the camera in the radiator trim.</p> <p>If the system has been switched off due to excessive outside temperatures, the system will switch back on automatically once it has cooled down.</p> <p>If the system detects that the camera is fully operational, the display message disappears.</p> <p>Night View Assist Plus is operational again.</p> <hr/> <p>Night View Assist Plus is faulty.</p> <p>► Visit a qualified specialist workshop.</p>
<b>Traffic Sign Assist Currently Unavailable See Operator's Manual</b>	<p>Traffic Sign Assist is temporarily inoperative. Possible causes are:</p> <ul style="list-style-type: none"> <li>• the windshield in the camera's field of vision is dirty.</li> <li>• visibility is impaired due to heavy rain, snow or fog.</li> </ul> <p>► Clean the windshield.</p> <p>If the system detects that the camera is fully operational, the display message disappears.</p> <p>Traffic Sign Assist is operational again.</p>
<b>Traffic Sign Assist Inoperative</b>	<p>Traffic Sign Assist is faulty.</p> <p>► Visit a qualified specialist workshop.</p>
<div style="border: 1px solid black; padding: 2px; display: inline-block;">HOLD</div> <b>Off</b>	<p>The HOLD function is deactivated. The vehicle is skidding. A warning tone also sounds.</p> <p>► Reactivate the HOLD function later (&gt; page 208).</p>
<b>DISTRONIC PLUS Off</b>	<p>DISTRONIC PLUS has been deactivated.</p> <p>If a warning tone also sounds, DISTRONIC PLUS has deactivated automatically (&gt; page 199).</p>
<b>DISTRONIC PLUS Now Available</b>	<p>DISTRONIC PLUS is operational again after having been temporarily unavailable. You can now reactivate DISTRONIC PLUS (&gt; page 199).</p>

Display messages	Possible causes/consequences and ► Solutions
<p><b>DISTRONIC PLUS Currently Unavailable</b> See Operator's Manual</p>	<p>DISTRONIC PLUS is temporarily inoperative. Steering Assist and Stop&amp;Go Pilot are temporarily inoperative. Possible causes are:</p> <ul style="list-style-type: none"> <li>• the radar sensor system is temporarily inoperative, e.g. due to electromagnetic radiation emitted by nearby TV or radio stations or other sources of electromagnetic radiation.</li> <li>• the system is outside the operating temperature range.</li> <li>• the on-board voltage is too low.</li> </ul> <p>A warning tone also sounds.</p> <p>When the causes stated above no longer apply, the display message disappears.</p> <p>DISTRONIC PLUS is operational again.</p> <p>If the display message does not disappear:</p> <ul style="list-style-type: none"> <li>► Pull over and stop the vehicle safely as soon as possible, paying attention to road and traffic conditions.</li> <li>► Secure the vehicle against rolling away (▷ page 189).</li> <li>► Restart the engine.</li> </ul>
<p><b>DISTRONIC PLUS Inoperative</b></p>	<p>DISTRONIC PLUS is defective. The following may have also failed:</p> <ul style="list-style-type: none"> <li>• BAS PLUS with Cross-Traffic Assist</li> <li>• PRE-SAFE® Brake</li> <li>• Steering Assist and Stop&amp;Go Pilot</li> </ul> <p>A warning tone also sounds.</p> <ul style="list-style-type: none"> <li>► Visit a qualified specialist workshop.</li> </ul>
<p><b>DISTRONIC PLUS Suspended</b></p>	<p>You have depressed the accelerator pedal. DISTRONIC PLUS is no longer controlling the speed of the vehicle.</p> <ul style="list-style-type: none"> <li>► Remove your foot from the accelerator pedal.</li> </ul>
<p><b>DISTRONIC PLUS - - - mph</b></p>	<p>An activation condition for DISTRONIC PLUS is not fulfilled.</p> <ul style="list-style-type: none"> <li>► Check the activation conditions for DISTRONIC PLUS (▷ page 199).</li> </ul>

Display messages	Possible causes/consequences and ► Solutions
<p>DTR+: Steering Assist. Currently Unavailable See Operator's Manual</p>	<p>Steering Assist and Stop&amp;Go Pilot are temporarily inoperative. Possible causes are:</p> <ul style="list-style-type: none"> <li>• the windshield in the camera's field of vision is dirty.</li> <li>• visibility is impaired due to heavy rain, snow or fog.</li> <li>• there have been no lane markings for an extended period.</li> <li>• the lane markings are worn, dark or covered, e.g. by dirt or snow.</li> </ul> <p>When the causes stated above no longer apply, the display message disappears.</p> <p>Steering Assist and Stop&amp;Go Pilot are operative again.</p> <p>If the display message does not disappear:</p> <ul style="list-style-type: none"> <li>► Pull over and stop the vehicle safely as soon as possible, paying attention to road and traffic conditions.</li> <li>► Secure the vehicle against rolling away (▷ page 189).</li> <li>► Clean the windshield.</li> </ul>
<p>DTR+: Steering Assist. Inoperative</p>	<p>Steering Assist and Stop&amp;Go Pilot are faulty. However, the DISTRONIC PLUS functions are still available. A warning tone also sounds.</p> <ul style="list-style-type: none"> <li>► Visit a qualified specialist workshop.</li> </ul>
<p>Cruise Control Inoperative</p>	<p>Cruise control is malfunctioning. A warning tone also sounds.</p> <ul style="list-style-type: none"> <li>► Visit a qualified specialist workshop.</li> </ul>
<p>Cruise Control - - - mph</p>	<ul style="list-style-type: none"> <li>• A condition for activating cruise control has not been met. You have tried to store a speed below 20 mph (30 km/h), for example.</li> <li>• ESP® is deactivated. The yellow ESP® OFF warning lamp is lit.</li> </ul> <p>► If conditions permit, drive faster than 20 mph (30 km/h) and store the speed.</p> <p>or</p> <ul style="list-style-type: none"> <li>► Check the activation conditions for cruise control (▷ page 197).</li> </ul> <p>or</p> <ul style="list-style-type: none"> <li>► Reactivate ESP® (▷ page 269).</li> </ul>
<p>Cruise Control Off</p>	<p>Cruise control has been deactivated. If a warning tone also sounds, cruise control has deactivated automatically (▷ page 197).</p>

Tires	
Display messages	Possible causes/consequences and ► Solutions
Check Tire Pressure Soon	<p>Canada only:</p> <p>The tire pressure loss warning system has detected a significant loss in pressure.</p> <p>A warning tone also sounds.</p> <p>Possible causes:</p> <ul style="list-style-type: none"> <li>• you have changed the positions of the wheels and tires or installed new wheels and tires.</li> <li>• the tire pressure in one or more tires has dropped</li> </ul> <p> <b>WARNING</b></p> <p>Tire pressures that are too low pose the following hazards:</p> <ul style="list-style-type: none"> <li>• they may burst, especially as the load and vehicle speed increase.</li> <li>• they may wear excessively and/or unevenly, which may greatly impair tire traction.</li> <li>• the driving characteristics, as well as steering and braking, may be greatly impaired.</li> </ul> <p>There is a risk of an accident.</p> <ul style="list-style-type: none"> <li>► Stop the vehicle without making any sudden steering or braking maneuvers. Pay attention to the traffic conditions as you do so.</li> <li>► Secure the vehicle against rolling away (▷ page 189).</li> <li>► Check the tires and, if necessary, follow the instructions for a flat tire (▷ page 367).</li> <li>► Check the tire pressures and, if necessary, correct the tire pressure.</li> <li>► Restart the tire pressure loss warning system when the tire pressure is correct (▷ page 394).</li> </ul>
Check Tire Pressure Then Restart Run Flat Indicator	<p>Canada only:</p> <p>The tire pressure loss warning system generated a display message and has not been restarted since.</p> <ul style="list-style-type: none"> <li>► Set the correct tire pressure in all four tires.</li> <li>► Restart the tire pressure loss warning system (▷ page 394).</li> </ul>
Run Flat Indicator Inoperative	<p>Canada only:</p> <p>The tire pressure loss warning system is faulty.</p> <ul style="list-style-type: none"> <li>► Visit a qualified specialist workshop.</li> </ul>
Please Correct Tire Pressure	<p>The tire pressure is too low in at least one of the tires, or the tire pressure difference between the wheels is too great.</p> <ul style="list-style-type: none"> <li>► Check the tire pressures at the next opportunity (▷ page 390).</li> <li>► If necessary, correct the tire pressure.</li> <li>► Restart the tire pressure monitor (▷ page 392).</li> </ul>

Display messages	Possible causes/consequences and ► Solutions
<p>Check Tires</p>	<p>The tire pressure in one or more tires has dropped significantly. The wheel position is shown in the multifunction display. A warning tone also sounds.</p> <p> <b>WARNING</b></p> <p>Tire pressures that are too low pose the following hazards:</p> <ul style="list-style-type: none"> <li>• they may burst, especially as the load and vehicle speed increase.</li> <li>• they may wear excessively and/or unevenly, which may greatly impair tire traction.</li> <li>• the driving characteristics, as well as steering and braking, may be greatly impaired.</li> </ul> <p>There is a risk of an accident.</p> <ul style="list-style-type: none"> <li>► Stop the vehicle without making any sudden steering or braking maneuvers. Pay attention to the traffic conditions as you do so.</li> <li>► Secure the vehicle against rolling away (▷ page 189).</li> <li>► Check the tires and, if necessary, follow the instructions for a flat tire (▷ page 367).</li> <li>► Check the tire pressure (▷ page 390).</li> <li>► If necessary, correct the tire pressure.</li> </ul>
<p>Warning Tire Malfunction</p>	<p>The tire pressure in one or more tires has dropped suddenly. The wheel position is shown in the multifunction display.</p> <p> <b>WARNING</b></p> <p>Driving with a flat tire poses a risk of the following hazards:</p> <ul style="list-style-type: none"> <li>• a flat tire affects the ability to steer or brake the vehicle.</li> <li>• you could lose control of the vehicle.</li> <li>• continued driving with a flat tire will cause excessive heat build-up and possibly a fire.</li> </ul> <p>There is a risk of an accident.</p> <ul style="list-style-type: none"> <li>► Stop the vehicle without making any sudden steering or braking maneuvers. Pay attention to the traffic conditions as you do so.</li> <li>► Secure the vehicle against rolling away (▷ page 189).</li> <li>► Check the tires and, if necessary, follow the instructions for a flat tire (▷ page 367).</li> </ul>
<p>Tire Press. Monitor Currently Unavailable</p>	<p>Because there is interference from a strong source of radio waves, no signals from the tire pressure sensors are detected. The tire pressure monitor is temporarily malfunctioning.</p> <ul style="list-style-type: none"> <li>► Drive on. The tire pressure monitor restarts automatically as soon as the problem has been resolved.</li> </ul>
<p>TirePress. Sensor(s) Missing</p>	<p>There is no signal from the tire pressure sensor of one or several wheels. The pressure of the affected tire is not displayed in the multifunction display.</p> <ul style="list-style-type: none"> <li>► Have the faulty tire pressure sensor replaced at a qualified specialist workshop.</li> </ul>



Display messages	Possible causes/consequences and ► Solutions
Tire Pressure Monitor Inoperative No Wheel Sensors	The wheels mounted do not have a suitable tire pressure sensor. The tire pressure monitor is deactivated. ► Mount wheels with suitable tire pressure sensors. The tire pressure monitor is activated automatically after driving for a few minutes.
Tire Press. Monitor Inoperative	The tire pressure monitor is faulty. ► Visit a qualified specialist workshop.

### Vehicle





Display messages	Possible causes/consequences and ► Solutions
Shift to 'P' or 'N' to Start Engine	You have attempted to start the engine with the transmission in position <b>R</b> or <b>D</b> . ► Shift the transmission to position <b>P</b> or <b>N</b> .
Apply Brake to Shift from 'P'	You have attempted to move the transmission selector lever to position <b>D</b> , <b>R</b> or <b>N</b> without depressing the brake pedal. ► Depress the brake pedal.
To Deselect P or N, Depress Brake and Start Engine	With the engine switched off, you have attempted to shift the transmission out of position <b>P</b> or <b>N</b> into another transmission position. ► Depress the brake pedal. ► Start the engine.
Transmission Not in P Risk of Vehicle Rolling Away	The driver's door is open or not fully closed and the transmission is in position <b>R</b> , <b>N</b> or <b>D</b> . A warning tone also sounds.  <b>WARNING</b> The vehicle may roll away. There is a risk of an accident. ► Shift the transmission to position <b>P</b> . ► Secure the vehicle against rolling away (▷ page 189). ► Close the driver's door completely.
Only Shift to 'P' when Vehicle is Stationary	The vehicle is moving. ► Pull over and stop the vehicle safely as soon as possible, paying attention to road and traffic conditions. ► Shift the transmission to position <b>P</b> .







Display messages	Possible causes/consequences and ► Solutions
<p>Service Required Do Not Shift Gears Visit Dealer</p>	<p>You cannot change the transmission position due to a malfunction. A warning tone also sounds.</p> <p>If transmission position <b>D</b> is selected:</p> <ul style="list-style-type: none"> <li>► Drive to a qualified specialist workshop without shifting the transmission from position <b>D</b>.</li> </ul> <p>If transmission position <b>R</b>, <b>N</b> or <b>P</b> is selected:</p> <ul style="list-style-type: none"> <li>► Secure the vehicle against rolling away (▷ page 189).</li> <li>► Notify a qualified specialist workshop or breakdown service.</li> </ul>
<p>Reversing Not Possible Service Required</p>	<p>You cannot shift into the transmission position <b>R</b> due to a malfunction. The transmission positions <b>P</b>, <b>N</b> or <b>D</b> continue to be available. A warning tone also sounds.</p> <ul style="list-style-type: none"> <li>► Visit a qualified specialist workshop.</li> </ul>
<p>Transmission Malfunction Stop</p>	<p>A malfunction has occurred in the mechanical transmission components. A warning tone also sounds. The gearbox automatically shifts to position <b>N</b>.</p> <ul style="list-style-type: none"> <li>► Pull over and stop the vehicle safely as soon as possible, paying attention to road and traffic conditions.</li> <li>► Shift the transmission to position <b>P</b>.</li> <li>► Secure the vehicle against rolling away (▷ page 189).</li> <li>► Notify a qualified specialist workshop or breakdown service.</li> </ul>
<p>Stop Vehicle Leave Engine Running Wait Transmission Cooling</p>	<p>PLUG-IN HYBRID vehicles:</p> <p>The transmission has overheated. Pulling away can be temporarily impaired or not possible.</p> <ul style="list-style-type: none"> <li>► Pull over and stop the vehicle safely as soon as possible, paying attention to road and traffic conditions. Do not continue driving under any circumstances.</li> <li>► Wait until the display message disappears before pulling away.</li> </ul>
<p>Auxiliary Battery Malfunction</p>	<p>The auxiliary battery for the transmission is no longer being charged.</p> <ul style="list-style-type: none"> <li>► Visit a qualified specialist workshop.</li> <li>► Until then, set the transmission to position <b>P</b> before you switch off the engine.</li> <li>► Before leaving the vehicle, apply the electric parking brake.</li> </ul>
	<p>The trunk lid is open.</p> <ul style="list-style-type: none"> <li>► Close the trunk lid.</li> </ul>



Display messages	Possible causes/consequences and ► Solutions
	<p>The hood is open. A warning tone also sounds.</p> <p><b>▲ WARNING</b></p> <p>The open hood may block your view when the vehicle is in motion. There is a risk of an accident.</p> <ul style="list-style-type: none"> <li>► Pull over and stop the vehicle safely as soon as possible, paying attention to road and traffic conditions.</li> <li>► Secure the vehicle against rolling away (▷ page 189).</li> <li>► Close the hood.</li> </ul>
 <p>To view the ext. mirror, adjust front-passenger seat or remove the head restraint.</p>	<p>At least one door is open. A warning tone also sounds.</p> <ul style="list-style-type: none"> <li>► Close all the doors.</li> </ul> <p>The front-passenger seat is in the chauffeur mode position and the head restraint is folded down.</p> <p><b>▲ WARNING</b></p> <p>If the front-passenger seat is the chauffeur mode position and the head restraint is folded down, the view of the front-passenger exterior mirror can be impaired. There is a risk of an accident.</p> <ul style="list-style-type: none"> <li>► Remove the head restraint on the front-passenger seat (▷ page 113).</li> </ul> <p>or</p> <ul style="list-style-type: none"> <li>► Move the front-passenger seat back into the normal position (▷ page 111).</li> </ul>
<p>Front-Passenger Seat Cannot Be Used Visit Workshop</p>	<ul style="list-style-type: none"> <li>• The front-passenger seat cannot be moved from the chauffeur mode position into the normal position. There is a malfunction.</li> <li>• The front passenger head restraint is folded down and can no longer be folded up. There is a malfunction.</li> </ul> <p><b>▲ WARNING</b></p> <p>If head restraints are not adjusted correctly, they cannot provide protection as intended. There is an increased risk of injury in the head and neck area, e.g. in the event of an accident or when braking.</p> <ul style="list-style-type: none"> <li>► Do not use the front-passenger seat.</li> <li>► Visit a qualified specialist workshop immediately.</li> </ul>
 <p>Before oper. front-pass. seat from rear, deactiv. override feature.</p>	<p>You have attempted to adjust the front-passenger seat from the rear compartment while the override feature is activated.</p> <ul style="list-style-type: none"> <li>► Deactivate the override feature for the rear side windows (▷ page 67).</li> <li>► Adjust the front-passenger seat from the rear (▷ page 108).</li> </ul>



Display messages	Possible causes/consequences and ► Solutions
 <p>Pre-Entry Climate Ctrl. (Via Smart-Key) Available Again After Engine Start</p>	<p>PLUG-IN HYBRID vehicles:</p> <p>With the engine switched off, you have attempted to switch on the pre-entry climate control more than twice.</p> <ul style="list-style-type: none"> <li>► Let the engine run for ten seconds. After running the engine, the pre-entry climate control is operational again.</li> </ul>
 <p>Pre-Entry Climate Ctrl. (Via Smart-Key) Inoperative HV Battery Low</p>	<p>PLUG-IN HYBRID vehicles:</p> <p>The on-board voltage is too low. The pre-entry climate control cannot be switched on.</p> <ul style="list-style-type: none"> <li>► Drive for a longer distance. The battery is being charged. When the condition of charge of the high-voltage battery is over the specified minimum, pre-entry climate control is operational again.</li> </ul>
 <p>Power Steering Malfunction See Operator's Manual</p>	<p>The power steering is malfunctioning. A warning tone also sounds.</p> <p> <b>WARNING</b></p> <p>You will need to use more force to steer. There is a risk of an accident.</p> <ul style="list-style-type: none"> <li>► Check whether you are able to apply the extra force required.</li> </ul> <p><b>If you are able to steer safely:</b></p> <ul style="list-style-type: none"> <li>► Drive on carefully.</li> <li>► Visit a qualified specialist workshop immediately.</li> </ul> <p><b>If you are unable to steer safely:</b></p> <ul style="list-style-type: none"> <li>► Do not drive on.</li> <li>► Consult a qualified specialist workshop.</li> </ul>
<p>Phone No Service</p>	<p>Your vehicle is outside the network provider's transmitter/receiver range.</p> <ul style="list-style-type: none"> <li>► Wait until the mobile phone operational readiness symbol appears in the multifunction display.</li> </ul>
 <p>Check Washer Fluid</p>	<p>The washer fluid level in the washer fluid reservoir has dropped below the minimum.</p> <ul style="list-style-type: none"> <li>► Add washer fluid (► page 357).</li> </ul>

SmartKey	
Display messages	Possible causes/consequences and ► Solutions
 <p>Key Does Not Belong to Vehicle</p>	<p>You have put the wrong SmartKey in the ignition lock.</p> <ul style="list-style-type: none"> <li>► Use the correct SmartKey.</li> </ul>
 <p>Take Your Key from Ignition</p>	<p>The SmartKey is in the ignition lock.</p> <ul style="list-style-type: none"> <li>► Remove the SmartKey.</li> </ul>
 <p>Obtain a New Key</p>	<p>The SmartKey needs to be replaced.</p> <ul style="list-style-type: none"> <li>► Visit a qualified specialist workshop.</li> </ul>
 <p>Replace Key Battery</p>	<p>The SmartKey battery is discharged.</p> <ul style="list-style-type: none"> <li>► Change the battery (► page 82).</li> </ul>
 <p>Don't Forget Your Key</p>	<p>The SmartKey is not in the ignition lock. You have opened the driver's door with the engine switched off.</p> <p>This display message is displayed in the multifunction display for a maximum of 60 seconds and is simply a reminder.</p> <ul style="list-style-type: none"> <li>► Take the SmartKey with you when you leave the vehicle.</li> </ul>
 <p>Key Not Detected (white display message)</p>	<p>The SmartKey is currently undetected.</p> <ul style="list-style-type: none"> <li>► Change the location of the SmartKey in the vehicle.</li> </ul> <p>If the SmartKey still cannot be detected:</p> <ul style="list-style-type: none"> <li>► Insert the SmartKey into the ignition lock and turn it to the desired position.</li> </ul>
 <p>Key Not Detected (red display message)</p>	<p>The SmartKey is not in the vehicle.</p> <p>A warning tone also sounds.</p> <p>If the engine is switched off, you can no longer lock the vehicle centrally or start the engine.</p> <ul style="list-style-type: none"> <li>► Pull over and stop the vehicle safely as soon as possible, paying attention to road and traffic conditions.</li> <li>► Secure the vehicle against rolling away (► page 189).</li> <li>► Locate the SmartKey.</li> <li>► Press <input type="button" value="OK"/> on the steering wheel to confirm the display message.</li> </ul>

Display messages	Possible causes/consequences and ► Solutions
	<p>Because there is interference from a strong source of radio waves, the key is not detected whilst the engine is running. A warning tone also sounds.</p> <ul style="list-style-type: none"> <li>► Pull over and stop the vehicle safely as soon as possible, paying attention to road and traffic conditions.</li> <li>► Secure the vehicle against rolling away (▷ page 189).</li> <li>► Insert the SmartKey into the ignition lock and bring into key mode.</li> </ul>
 <p>Remove 'Start' Button and Insert Key</p>	<p>The SmartKey is continually undetected. The SmartKey detection function has a temporary malfunction or is faulty. A warning tone also sounds.</p> <ul style="list-style-type: none"> <li>► Insert the SmartKey into the ignition lock and turn it to the desired position.</li> <li>► Visit a qualified specialist workshop.</li> </ul>



## Warning and indicator lamps in the instrument cluster

### General notes

Some systems carry out a self-diagnosis when the ignition is switched on. Therefore, some indicator and warning lamps may light up or flash temporarily. This behavior is non-critical. These indicator and warning lamps only indicate a malfunction if they light up or flash after starting the engine or whilst driving.

### Safety

#### Seat belts

Warning/ indicator lamp	► Signal type Possible causes/consequences and ► Solutions
	<p>► After starting the engine, the red seat belt warning lamp lights up for 6 seconds. The seat belt warning lamp reminds the driver and front passenger to fasten their seat belts.</p> <ul style="list-style-type: none"> <li>► Fasten your seat belt (▷ page 49).</li> </ul>
	<p>► After starting the engine, the red seat belt warning lamp lights up. In addition, a warning tone sounds for up to 6 seconds. The driver's seat belt is not fastened.</p> <ul style="list-style-type: none"> <li>► Fasten your seat belt (▷ page 49). The warning tone ceases.</li> </ul>

Warning/  
indicator  
lamp

## ▷ Signal type

## Possible causes/consequences and ► Solutions



▷ The red seat belt warning lamp lights up after the engine starts, as soon as the driver's or the front-passenger door is closed.

The driver or front passenger has not fastened their seat belt.

- ▶ Fasten your seat belt (▷ page 49).  
The warning lamp goes out.

There are objects on the front-passenger seat.

- ▶ Remove the objects from the front-passenger seat and stow them in a secure place.  
The warning lamp goes out.



▷ The red seat belt warning lamp flashes and an intermittent audible warning sounds.





The driver or front passenger has not fastened their seat belt. The vehicle is being driven faster than 15 mph (25 km/h) or has briefly been driven faster than 15 mph (25 km/h).

- ▶ Fasten your seat belt (▷ page 49).  
The warning lamp goes out and the intermittent warning tone ceases.

There are objects on the front-passenger seat. The vehicle is being driven faster than 15 mph (25 km/h) or has briefly been driven faster than 15 mph (25 km/h).

- ▶ Remove the objects from the front-passenger seat and stow them in a secure place.  
The warning lamp goes out and the intermittent warning tone ceases.

## Safety systems



Warning/ indicator lamp	▷ Signal type Possible causes/consequences and ▶ Solutions
<b>RBS</b>	<p>▷ PLUG-IN HYBRID vehicles: The yellow RBS (recuperative brake system) warning lamp is on. In addition, there may be a warning tone.</p> <p> <b>Risk of accident</b></p> <p>RBS is malfunctioning. Pedal travel may be longer than usual and braking performance may be affected. The automatic engine switch-off function may also be deactivated.</p> <ul style="list-style-type: none"> <li>▶ Observe the messages in the multifunction display (▷ page 277).</li> <li>▶ Drive on carefully.</li> <li>▶ Visit a qualified specialist workshop immediately.</li> </ul>
<b>BRAKE</b>	<p>▷ PLUG-IN HYBRID vehicles: The red brake system warning lamp is on. A warning tone also sounds.</p> <p> <b>Risk of accident</b></p> <p>RBS is malfunctioning. Pedal travel may be longer than usual and braking performance may be affected.</p> <ul style="list-style-type: none"> <li>▶ Pull over and stop the vehicle safely as soon as possible, paying attention to road and traffic conditions. Do not continue driving under any circumstances.</li> <li>▶ Consult a qualified specialist workshop.</li> <li>▶ Observe the additional display messages in the multifunction display.</li> </ul>
<b>BRAKE</b> 	<p>▷ <b>BRAKE</b> (USA only) or  (Canada only): the red brake system warning lamp is lit while the engine is running. A warning tone also sounds.</p> <p> <b>WARNING</b></p> <p>The brake boosting effect is malfunctioning and the braking characteristics may be affected. There is a risk of an accident.</p> <ul style="list-style-type: none"> <li>▶ Pull over and stop the vehicle safely as soon as possible, paying attention to road and traffic conditions. Do not continue driving under any circumstances.</li> <li>▶ Secure the vehicle against rolling away (▷ page 189).</li> <li>▶ Consult a qualified specialist workshop.</li> <li>▶ Observe the additional display messages in the multifunction display.</li> </ul>

Warning/  
indicator  
lamp

## ▷ Signal type

## Possible causes/consequences and ► Solutions



▷  (USA only) or  (Canada only): the red brake system warning lamp is lit while the engine is running.

A warning tone also sounds.

There is not enough brake fluid in the brake fluid reservoir.

 **WARNING**

The braking effect may be impaired.

There is a risk of an accident.

- ▶ Pull over and stop the vehicle safely as soon as possible, paying attention to road and traffic conditions. Do not continue driving under any circumstances.
- ▶ Secure the vehicle against rolling away (▷ page 189).
- ▶ Do not add brake fluid. Adding more will not correct the malfunction.
- ▶ Consult a qualified specialist workshop.
- ▶ Observe the additional display messages in the multifunction display.



▷ USA only: the red brake system warning lamp is lit while the engine is running. The multifunction display also shows a display message with the  symbol.

The brake pads/linings have reached their wear limit.

- ▶ Visit a qualified specialist workshop.



▷ The yellow ABS warning lamp is lit while the engine is running.

ABS (Anti-lock Braking System) is deactivated due to a malfunction. Therefore BAS (Brake Assist), BAS PLUS with Cross-Traffic Assist, COLLISION PREVENTION ASSIST PLUS, ESP® (Electronic Stability Program), PRE-SAFE®, PRE-SAFE® PLUS, PRE-SAFE® Brake, the HOLD function, Hill Start Assist, Crosswind Assist, STEER CONTROL, Active Lane Keeping Assist and Active Blind Spot Assist are also deactivated.

ATTENTION ASSIST is deactivated.

 **WARNING**

The brake system continues to function normally, but without the functions listed above. The wheels could therefore lock if you brake hard, for example.

The steerability and braking characteristics may be severely affected. The braking distance in an emergency braking situation can increase.

If ESP® is not operational, ESP® is unable to stabilize the vehicle.

There is an increased risk of skidding and an accident.

- ▶ Observe the additional display messages in the multifunction display.
- ▶ Drive on carefully.
- ▶ Visit a qualified specialist workshop immediately.

If the ABS control unit is faulty, there is also a possibility that other systems, such as the navigation system or the automatic transmission, will not be available.

Warning/  
indicator  
lamp

## ▷ Signal type

## Possible causes/consequences and ► Solutions



▷ The yellow ABS warning lamp is lit while the engine is running.

A warning tone also sounds.

EBD is not available due to a malfunction. Therefore ABS, BAS, BAS PLUS with Cross-Traffic Assist, COLLISION PREVENTION ASSIST PLUS, ESP<sup>®</sup>, PRE-SAFE<sup>®</sup>, PRE-SAFE<sup>®</sup> PLUS, PRE-SAFE<sup>®</sup> Brake, the HOLD function, Hill Start Assist, Crosswind Assist, STEER CONTROL, Active Lane Keeping Assist and Active Blind Spot Assist are also unavailable.

ATTENTION ASSIST is deactivated.

**WARNING**

The brake system continues to function normally, but without the functions listed above. The front and rear wheels could therefore lock if you brake hard, for example.

The steerability and braking characteristics may be severely affected. The braking distance in an emergency braking situation can increase.

If ESP<sup>®</sup> is not operational, ESP<sup>®</sup> is unable to stabilize the vehicle.

There is an increased risk of skidding and an accident.

- ▶ Observe the additional display messages in the multifunction display.
- ▶ Drive on carefully.
- ▶ Visit a qualified specialist workshop immediately.



▷ **BRAKE** (USA only), (Canada only): the red brake warning lamp, the yellow ESP<sup>®</sup> warning lamp and the yellow ABS warning lamp are lit while the engine is running.

ABS and ESP<sup>®</sup> are not available due to a malfunction. Therefore BAS, BAS PLUS with Cross-Traffic Assist, COLLISION PREVENTION ASSIST PLUS, EBD, PRE-SAFE<sup>®</sup>, PRE-SAFE<sup>®</sup> PLUS, PRE-SAFE<sup>®</sup> Brake, the HOLD function, Hill Start Assist, Crosswind Assist, STEER CONTROL, Active Lane Keeping Assist and Active Blind Spot Assist are also unavailable.

ATTENTION ASSIST is deactivated.

**WARNING**

The brake system continues to function normally, but without the functions listed above. The front and rear wheels could therefore lock if you brake hard, for example.

The steerability and braking characteristics may be severely affected. The braking distance in an emergency braking situation can increase.

If ESP<sup>®</sup> is not operational, ESP<sup>®</sup> is unable to stabilize the vehicle.

There is an increased risk of skidding and an accident.

- ▶ Observe the additional display messages in the multifunction display.
- ▶ Drive on carefully.
- ▶ Visit a qualified specialist workshop immediately.

Warning/  
indicator  
lamp

## ▷ Signal type

## Possible causes/consequences and ► Solutions



▷ The yellow ESP® warning lamp flashes while the vehicle is in motion. ESP® or traction control has intervened because there is a risk of skidding or at least one wheel has started to spin.

Cruise control or DISTRONIC PLUS is deactivated.

- ▶ When pulling away, only depress the accelerator pedal as far as necessary.
- ▶ Ease off the accelerator pedal while the vehicle is in motion.
- ▶ Adapt your driving style to suit the road and weather conditions.
- ▶ Do not deactivate ESP®.

In rare cases (▷ page 74), it may be best to deactivate ESP®.

Observe the important safety notes on ESP® (▷ page 73).



▷ The yellow ESP® warning lamp is lit while the engine is running.

ESP®, BAS, BAS PLUS with Cross-Traffic Assist, COLLISION PREVENTION ASSIST PLUS, PRE-SAFE®, PRE-SAFE® PLUS, PRE-SAFE® Brake, the HOLD function, Hill Start Assist, Crosswind Assist, STEER CONTROL, Active Lane Keeping Assist and Active Blind Spot Assist are unavailable due to a malfunction.

ATTENTION ASSIST is deactivated.

 **WARNING**

The brake system continues to function normally, but without the functions listed above.









The braking distance in an emergency braking situation can thus increase.

If ESP® is not operational, ESP® is unable to stabilize the vehicle.

There is an increased risk of skidding and an accident.

- ▶ Observe the additional display messages in the multifunction display.
- ▶ Drive on carefully.
- ▶ Visit a qualified specialist workshop immediately.



Warning/ indicator lamp	▷ Signal type Possible causes/consequences and ▶ Solutions
	<p>▷ The yellow ESP<sup>®</sup> OFF warning lamp is lit while the engine is running. ESP<sup>®</sup> is deactivated.</p> <p> <b>WARNING</b></p> <p>If ESP<sup>®</sup> is switched off, ESP<sup>®</sup> is unable to stabilize the vehicle. Further driving systems or driving safety systems are thus restricted, e.g. Active Blind Spot Assist. The system does not perform course-correcting brake applications.</p> <p>There is an increased risk of skidding and an accident.</p> <ul style="list-style-type: none"> <li>▶ Reactivate ESP<sup>®</sup>. <ul style="list-style-type: none"> <li>In rare cases (▷ page 74), it may be best to deactivate ESP<sup>®</sup>.</li> <li>Observe the important safety notes on ESP<sup>®</sup> (▷ page 73).</li> </ul> </li> <li>▶ Adapt your driving style to suit the road and weather conditions.</li> </ul> <p>If ESP<sup>®</sup> cannot be activated:</p> <ul style="list-style-type: none"> <li>▶ Drive on carefully.</li> <li>▶ Contact a qualified specialist workshop and have ESP<sup>®</sup> checked.</li> </ul>
 	<p>▷  (USA only) or  (Canada only): the red indicator lamp for the electric parking brake flashes or is lit and/or the yellow warning lamp for the electric parking brake is lit.</p> <ul style="list-style-type: none"> <li>▶ Observe the additional display messages in the multifunction display.</li> </ul>
	<p>▷ The red restraint system warning lamp is lit while the engine is running. The restraint system is faulty.</p> <p> <b>WARNING</b></p> <p>The air bags or Emergency Tensioning Devices may either be triggered unintentionally or, in the event of an accident, may not be triggered.</p> <p>There is an increased risk of injury.</p> <ul style="list-style-type: none"> <li>▶ Observe the additional display messages in the multifunction display.</li> <li>▶ Drive on carefully.</li> <li>▶ Contact a qualified specialist workshop and have the restraint system checked.</li> </ul> <p>For further information about the restraint system, see (▷ page 44).</p>

## Engine

Warning/  
indicator  
lamp

## ▷ Signal type

## Possible causes/consequences and ▶ Solutions



▷ The yellow Check Engine warning lamp lights up while the engine is running. There may be a malfunction, for example:

- in the engine management
- in the fuel injection system
- in the exhaust system
- in the ignition system
- in the fuel system

The emission limit values may be exceeded and the engine may be in emergency mode.

▶ Visit a qualified specialist workshop immediately.

**i** In some states, you must immediately visit a qualified specialist workshop as soon as the yellow Check Engine warning lamp lights up. This is due to the legal requirements in effect in these states. If in doubt, check whether such legal regulations apply in the state in which you are currently driving.



▷ The yellow reserve fuel warning lamp lights up while the engine is running. The fuel level has dropped into the reserve range.

▶ Refuel at the nearest gas station.



▷ The yellow reserve fuel warning lamp flashes while the vehicle is in motion. In addition, the  Check Engine warning lamp may light up.

The fuel filler cap is not closed correctly or the fuel system is leaking.

- ▶ Check that the fuel filler cap is correctly closed.
- ▶ **If the fuel filler cap is not correctly closed:** close the fuel filler cap.
- ▶ **If the fuel filler cap is closed:** visit a qualified specialist workshop.



▷ The red coolant warning lamp comes on while the engine is running. The coolant temperature gauge is at the beginning of the cold range.

The temperature sensor for the coolant temperature gauge is defective.

The coolant temperature is no longer being monitored. There is a risk of engine damage if the coolant temperature is too high.

- ▶ Pull over and stop the vehicle safely and switch off the engine, paying attention to road and traffic conditions. Do not continue driving under any circumstances.
- ▶ Secure the vehicle against rolling away (▷ page 189).
- ▶ Consult a qualified specialist workshop.

Warning/  
indicator  
lamp▷ Signal type  
Possible causes/consequences and ▶ Solutions

- ▷ The red coolant warning lamp comes on while the engine is running. The coolant level is too low.
- If the coolant level is correct, the airflow to the engine radiator may be blocked or the electric engine radiator fan may be malfunctioning.
- The coolant is too hot and the engine is no longer being cooled sufficiently.
- ▶ Observe the additional display messages in the multifunction display.
  - ▶ Pull over and stop the vehicle safely and switch off the engine, paying attention to road and traffic conditions.
  - ▶ Secure the vehicle against rolling away (▷ page 189).
  - ▶ Leave the vehicle and keep a safe distance from the vehicle until the engine has cooled down.
  - ▶ Check the coolant level and add coolant, observing the warning notes (▷ page 356).
  - ▶ If you have to add coolant frequently, have the engine cooling system checked.
  - ▶ Make sure that the air supply to the engine radiator is not blocked, e.g. by snow, slush or ice.
  - ▶ Do not start the engine again until the coolant temperature is below 257 °F (125 °C). Otherwise, the engine could be damaged.
  - ▶ Drive to the nearest qualified specialist workshop.
  - ▶ Avoid heavy loads on the engine as you do so, e.g. driving in mountainous terrain and stop-start traffic.



- ▷ The red coolant warning lamp comes on while the engine is running. A warning tone also sounds.

The coolant temperature has exceeded 255 °F (124 °C). The airflow to the engine radiator may be blocked or the coolant level may be too low.

**WARNING**

The engine is not being cooled sufficiently and may be damaged.

Do not drive when your engine is overheated. This can cause some fluids which may have leaked into the engine compartment to catch fire.

Steam from the overheated engine can also cause serious burns which can occur just by opening the hood.

There is a risk of injury.

- ▶ Observe the additional display messages in the multifunction display.
- ▶ Pull over and stop the vehicle safely and switch off the engine, paying attention to road and traffic conditions.
- ▶ Secure the vehicle against rolling away (▷ page 189).
- ▶ Leave the vehicle and keep a safe distance from the vehicle until the engine has cooled down.
- ▶ Check the coolant level and add coolant, observing the warning notes (▷ page 356).
- ▶ If you have to add coolant frequently, have the engine cooling system checked.
- ▶ Make sure that the air supply to the engine radiator is not blocked, e.g. by snow, slush or ice.

**Warning/  
indicator  
lamp****▷ Signal type****Possible causes/consequences and ► Solutions**

- ▶ At coolant temperatures below 257 °F (125 °C), you can continue driving to the nearest qualified specialist workshop.
- ▶ Avoid heavy loads on the engine as you do so, e.g. driving in mountainous terrain and stop-start traffic.

**Driving systems****Warning/  
indicator  
lamp****▷ Signal type****Possible causes/consequences and ► Solutions**

▷ The red distance warning lamp lights up while the vehicle is in motion. A warning tone also sounds.

You are approaching a vehicle, a pedestrian or a stationary obstacle in your line of travel at too high a speed.

- ▶ Be prepared to brake immediately.
- ▶ Pay careful attention to the traffic situation. You may have to brake or take evasive action.

Further information on PRE-SAFE® Brake (▷ page 75).

For further information about the distance warning function of COLLISION PREVENTION ASSIST PLUS, see (▷ page 71).

## Tires

Warning/  
indicator  
lamp

## ▷ Signal type

## Possible causes/consequences and ► Solutions



▷ The yellow combination low tire pressure telltale/TPMS malfunction telltale for the TPMS (pressure loss or malfunction) is lit.

The tire pressure monitor has detected a loss of pressure in at least one of the tires.

 **WARNING**

Tire pressures that are too low pose the following hazards:

- they may burst, especially as the load and vehicle speed increase.
- they may wear excessively and/or unevenly, which may greatly impair tire traction.
- the driving characteristics, as well as steering and braking, may be greatly impaired.

There is a risk of an accident.

- ▶ Stop the vehicle without making any sudden steering or braking maneuvers. Pay attention to the traffic conditions as you do so.
- ▶ Secure the vehicle against rolling away (▷ page 189).
- ▶ Observe the additional display messages in the multifunction display.
- ▶ Check the tires and, if necessary, follow the instructions for a flat tire (▷ page 367).
- ▶ Check the tire pressure (▷ page 390).
- ▶ If necessary, correct the tire pressure.



▷ The yellow combination low tire pressure telltale/TPMS malfunction telltale for the TPMS (pressure loss or malfunction) flashes for approximately one minute and then remains lit.

The tire pressure monitor is faulty.

 **WARNING**

The system is possibly unable to recognize or register low tire pressure.

There is a risk of an accident.

- ▶ Observe the additional display messages in the multifunction display.
- ▶ Visit a qualified specialist workshop immediately.

## Vehicle

Warning/  
indicator  
lamp

## ▷ Signal type

## Possible causes/consequences and ▶ Solutions



▷ The red power steering warning lamp is lit while the engine is running. The power steering is malfunctioning. A warning tone also sounds.

**WARNING**

You will need to use more force to steer. There is a risk of an accident.

- ▶ Check whether you are able to apply the extra force required.

**If you are able to steer safely:**

- ▶ Drive on carefully.
- ▶ Visit a qualified specialist workshop immediately.

**If you are unable to steer safely:**

- ▶ Do not drive on.
- ▶ Consult a qualified specialist workshop.

## Useful information

- i** This Operator's Manual describes all models and all standard and optional equipment of your vehicle available at the time of publication of the Operator's Manual. Country-specific differences are possible. Please note that your vehicle may not be equipped with all features described. This also applies to safety-related systems and functions.
- i** Read the information on qualified specialist workshops (▷ page 28).

## Stowage areas

### Loading guidelines

#### WARNING

Combustion engines emit poisonous exhaust gases such as carbon monoxide. Exhaust gases can enter the vehicle interior if the trunk lid is open when the engine is running, especially if the vehicle is in motion. There is a risk of poisoning.

Always switch off the engine before opening the trunk lid. Never drive with the trunk lid open.

#### WARNING

If objects, luggage or loads are not secured or not secured sufficiently, they could slip, tip over or be flung around and thereby hit vehicle occupants. There is a risk of injury, particularly in the event of sudden braking or a sudden change in direction.

Always store objects so that they cannot be flung around. Secure objects, luggage or loads against slipping or tipping before the journey.

#### WARNING

The exhaust tail pipe and tail pipe trim can become very hot. If you come into contact with these parts of the vehicle, you could burn yourself. There is a risk of injury.

Always be particularly careful around the exhaust tail pipe and the tail pipe trim. Allow

these components to cool down before touching them.

The handling characteristics of a laden vehicle are dependent on the distribution of the load within the vehicle. For this reason, you should observe the following notes when transporting a load:

- Never exceed the maximum permissible gross vehicle weight or the gross axle weight rating of the vehicle (including occupants). The values are specified on the vehicle identification plate on the B-pillar of the driver's door.
- The trunk is the preferred place to carry objects.
- Position heavy loads as far forwards as possible and as low down in the trunk as possible.
- The load must not protrude above the upper edge of the seat backrests.
- Always place the load behind unoccupied seats if possible.
- Secure the load with sufficiently strong and wear-resistant tie-downs. Pad sharp edges for protection.

### Stowage spaces

#### Important safety notes

#### WARNING

If objects in the passenger compartment are stowed incorrectly, they can slide or be thrown around and hit vehicle occupants. In addition, cupholders, open stowage spaces and mobile phone brackets cannot always retain all objects they contain. There is a risk of injury, particularly in the event of sudden braking or a sudden change in direction.

- Always stow objects so that they cannot be thrown around in such situations.
- Always make sure that objects do not protrude from stowage spaces, parcel nets or stowage nets.

- Close the lockable stowage spaces before starting a journey.
- Always stow and secure heavy, hard, pointed, sharp-edged, fragile or bulky objects in the trunk.

Observe the loading guidelines (▷ page 325).

## Stowage compartments in the front

### Glove box

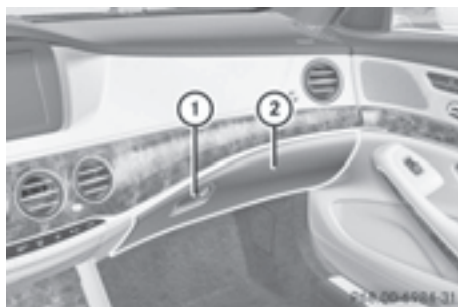

- ▶ **To open:** pull handle ① and open glove box flap ②.
- ▶ **To close:** fold glove box flap ② upwards until it engages.

The glove box can be cooled (▷ page 159).

The glove box contains:

- a coin holder
- a pen holder
- three credit card holders
- a holder for the multimedia system remote control.



The glove box can only be locked and unlocked using the mechanical key (▷ page 81).

- ▶ **To lock:** insert the mechanical key into the lock and turn it 90° clockwise to position ②.
- ▶ **To unlock:** insert the mechanical key into the lock and turn it 90° counter-clockwise to position ①.

### Eyeglasses compartment



- ▶ **To open:** press marking ①. The eyeglasses compartment opens downwards.
- ▶ **To close:** press marking ① again and the eyeglasses compartment returns upwards and engages.

Make sure that the eyeglasses compartment is always closed while the vehicle is in motion.

### Stowage compartments in the center console



- ▶ **To open:** briefly press marking ②.
- ▶ **To close:** push stowage compartment ① in the direction of the arrow until it engages.



### Stowage compartment under the armrest

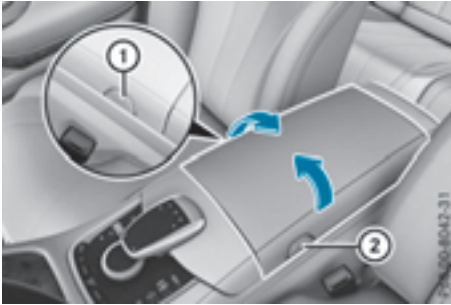

- **To open:** press button ① or ② and fold the armrest to the left or right.

Depending on the vehicle's equipment, a USB port, an AUX-IN jack or a Media Interface are installed in the stowage compartment. A Media Interface is a universal interface for portable audio or video equipment, e.g. for an iPod®, iPhone® or MP3 player (see the separate multimedia system operating instructions).

### Stowage compartments in the doors



You can store items such as a rolled up fluorescent jacket and a small umbrella in stowage compartment ② in the doors.

In doors ① you can store bottles with a capacity of up to 34 fl. oz. (1.0 liter).

### Stowage space in the rear

#### Stowage compartment in the rear seat armrest



Vehicles with a rear bench seat:

- **To open:** fold down the seat armrest.
- Pull handle ① and fold the armrests upwards.



Vehicles with electrically adjustable outer seats:

- **To open:** fold down the seat armrest.
- Pull up on handle ① and fold the armrest upwards.

#### Stowage compartment in the rear-compartment center console



Vehicles with individual seats and center console in the rear

- ▶ Pull up on handle ① and fold the armrest upwards.

Depending on the vehicle's equipment, a USB port, an AUX-IN jack, a mobile phone bracket or a 115 V or 230 V socket are installed in the stowage compartment.

### Stowage box in the rear seat backrest

- ! Do not sit on or support your body weight on the rear seat armrest when it is folded down, as you could otherwise damage it.



Vehicles with a rear bench seat:

- ▶ **To open:** fold down the rear armrest.
- ▶ Pull handle ① and fold down cover ②.



Vehicles with electrically adjustable outer seats:

- ▶ **To open:** fold down the rear armrest.
- ▶ Pull handle ① and fold down cover ②.



Vehicles with individual seats and center console in the rear:

- ▶ **To open:** fold down the rear armrest.
- ▶ Pull handle ① and fold down cover ②.

Depending on the vehicle's equipment, a DVD player is installed instead of a stowage compartment.

### Folding table

#### WARNING

If the folding table is folded out while the vehicle is in motion, passengers can be thrown against it, particularly in the event of an accident, heavy braking or a sudden change of direction. There is a risk of injury.

Fold the folding table away before each journey.



- ▶ **To fold out:** open rear armrest ① (▷ page 327).
- ▶ Pull the folding table forwards and upwards by recess ② or ③ and swing outwards.
- ▶ Fold the table panels apart.
- ▶ **To fold in:** fold the table panels together and swing in the folding table.

## Stowage nets

Stowage nets are located:

- in the front-passenger footwell
- on the back of the driver's and the front-passenger seat
- on the left and right-hand side in the trunk

Observe the loading guidelines (▷ page 325) and the safety notes regarding stowage spaces (▷ page 325).

## Securing loads using parcel net hooks

### General notes

Observe the following notes on securing loads:

- Secure the load using the parcel net hooks.
- Do not use elastic straps or nets to secure a load, as these are only intended as an anti-slip protection for light loads.
- Do not route tie-downs across sharp edges or corners.
- Pad sharp edges for protection.

## Trunk

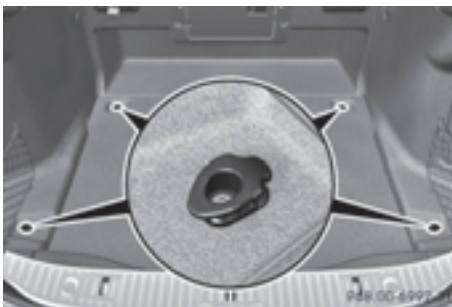

Vehicles without PLUG-IN HYBRID operation

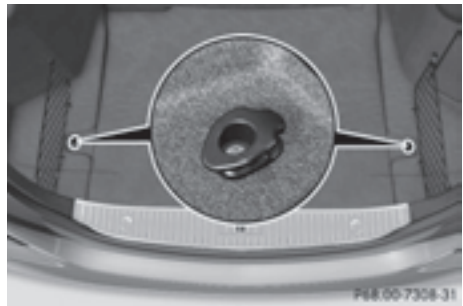

Vehicles with PLUG-IN HYBRID operation

There are four parcel net hooks or two parcel net hooks (vehicles with PLUG-IN HYBRID operation) in the trunk.

## Stowage well under the trunk floor



- ▶ **To open:** open the trunk lid.
- ▶ Press handle ② on the ribbing downwards. Handle ② folds upwards.
- ▶ Swing trunk floor ① upwards using handle ② until it rests against the trunk partition.



- ▶ Fold out hook ③ on the underside of the trunk floor.



- ▶ Clip hook (3) into groove (4).
- ▶ **To close:** unclip hook (3) from groove (4).
- ▶ Fasten hook (3) to the bracket on the underside of the trunk floor.
- ▶ Fold the trunk floor down.

### Roof carrier

#### Important safety notes

##### WARNING

When you load the roof, the center of gravity of the vehicle rises and the driving characteristics change. If you exceed the maximum roof load, the driving characteristics, as well as steering and braking, will be greatly impaired. There is a risk of an accident.

Never exceed the maximum roof load and adjust your driving style.

You will find information on the maximum roof load in the "Technical data" section (▶ page 433).

**!** Mercedes-Benz recommends that you only use roof carriers that have been tested and approved for Mercedes-Benz vehicles. This helps to avoid damage to the vehicle.

Position the load on the roof carrier in such a way that the vehicle will not sustain damage even when it is in motion.

Ensure that, depending on the vehicle's equipment, you can raise the panorama roof with power tilt/sliding panel fully and open the trunk lid fully when the roof carrier is installed.

**!** To avoid damaging or scratching the covers, do not use metallic or hard objects to open them.

An incorrectly secured roof carrier or roof load may become detached from the vehicle. You must therefore ensure that you observe the roof carrier manufacturer's installation instructions.

**Vehicles with a panorama roof with power tilt/sliding panel:** the panorama roof with power tilt/sliding panel cannot be opened if a roof carrier is installed. The panorama roof with power tilt/sliding panel can still be raised to allow ventilation of the vehicle interior.

If the panorama roof with power tilt/sliding panel makes contact with a roof carrier approved by Mercedes-Benz, the sunroof will lower slightly but remain raised at the rear.

#### Attaching the roof carrier

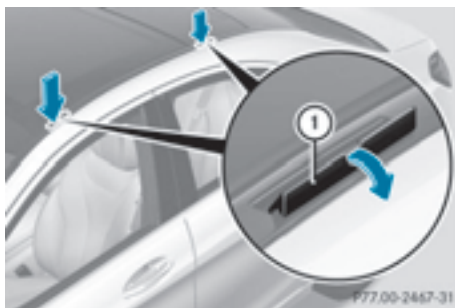

- ▶ Fold covers (1) upwards in the direction of the arrow.
- ▶ Only secure the roof carrier to the anchorage points under covers (1).
- ▶ Observe the manufacturer's installation instructions.

### Features

#### Cup holder

#### Important safety notes

##### WARNING

If objects in the passenger compartment are stowed incorrectly, they can slide or be thrown around and hit vehicle occupants. In addition, cupholders, open stowage spaces and mobile phone brackets cannot always

retain all objects they contain. There is a risk of injury, particularly in the event of sudden braking or a sudden change in direction.

- Always stow objects so that they cannot be thrown around in such situations.
- Always make sure that objects do not protrude from stowage spaces, parcel nets or stowage nets.
- Close the lockable stowage spaces before starting a journey.
- Always stow and secure heavy, hard, pointed, sharp-edged, fragile or bulky objects in the trunk.

Observe the loading guidelines (▷ page 325). Mercedes-Maybach vehicles equipped with champagne glasses: for your own safety, when using champagne glasses, please observe the following:

- do not use the champagne glasses while the vehicle is in motion
- do not use champagne glasses made of breakable glass, and store them in the trunk if possible

**!** Only use the cup holders for containers of the right size and which have lids. The drinks could otherwise spill.

**!** Do not expose drinks bottles in the cup holder in the center console to continuous, strong and direct sunlight. The passenger compartment in the area of the center console can otherwise be damaged by the concentrated and reflected sunlight.

### Cup holder in the front-compartment center console



- ▶ **To open:** open the stowage compartment (▷ page 326).
- ▶ Open the protective flap if necessary.
- ▶ **To remove:** slide catch ① forwards and pull the cup holder upwards.
- ▶ **To insert:** make sure that the protective flap is closed.
- ▶ Insert the cup holder and slide catch ① back.

You can remove the cup holder and the rubber mat for cleaning. Clean them with clean, luke-warm water only.

### Cup holders in the rear seat armrest

#### Vehicles with a rear bench seat

**!** Close the cup holder before folding the rear seat armrest up. Otherwise, the cup holder could be damaged.



- ▶ Fold down the rear seat armrest.
- ▶ **To open:** press the front of cup holder ① or ②. Cup holder ① or ② extends automatically.
- ▶ **To fold out:** place a container in the cup holder. The cup holder folds down automatically.
- ▶ **To fold in:** remove the container. The cup holder folds in automatically.
- ▶ **To close:** slide cup holder ① or ② back until it engages.

### Vehicles with electrically adjustable rear bench seats



- ▶ Fold down the rear seat armrest.
- ▶ **To open:** press down base (2) of the cup holder in the middle until it engages.
- ▶ **To close:** press closing button (1). Base (2) of cup holder pops up.

The cup holder insert can be removed for cleaning. Clean with clear, lukewarm water only.

- ❗ Please do not pull out the cup holder insert any further than 15 mm. Otherwise, the wooden trim on the rear seat armrest could be damaged.

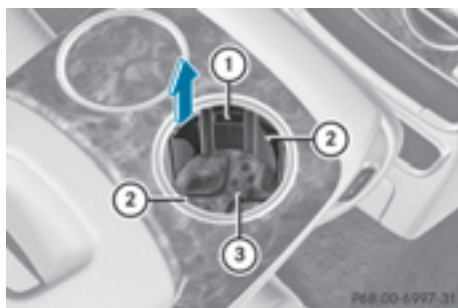

- ▶ **To remove the insert:** press down base (3) of the cup holder in the middle until it engages.
- ▶ Press both retaining clips (2) and pull the cup holder insert upwards approximately 15 mm.
- ▶ Press button (1). Base (3) of cup holder pops up.
- ▶ Remove the insert from the rear seat armrest completely.

- ❗ Make sure that the cup holder insert has been inserted into the recess correctly. Otherwise, the wooden trim on the rear seat armrest could be damaged.



- ▶ **To install the insert:** make sure that base (2) of the cup holder is in the upper position.
- ▶ Place the cup holder insert into the recess in the rear seat armrest such that button (1) is facing forwards.
- ▶ Press the cup holder insert down.
- ▶ Press outer ring (3) of the cup holder insert, until the cup holder insert engages audibly.

### Temperature controlled cup holder in the rear compartment



Example: Sedan

- ① Cup holder
- ② Switch

The temperature-controlled cup holder can be used to keep cold drinks cool and warm drinks warm.

When you use the warming function, the metal insert of the cup holder is heated. Therefore, do not touch the cup holder insert.

- ▶ Turn the SmartKey to position **2** in the ignition lock (> page 162).
- ▶ **To switch on the cooling function:** press and hold button (2) until the blue indicator lamp on the button lights up.

- ▶ **To switch on the heating function:** press and hold button ② until the red indicator lamp on the button lights up.
- ▶ **To switch off the function:** press and hold button ② until the indicator lamp on the button goes out.

The rubber mat can be removed for cleaning. Clean with clear, lukewarm water only.

Do not use hard or sharp objects to clean the cup holder. Use only a soft cloth to clean it.

## Sun visors

### Overview

#### ⚠ WARNING

If the mirror cover of the vanity mirror is folded up when the vehicle is in motion, you could be blinded by incident light. There is a risk of an accident.

Always keep the mirror cover folded down while driving.

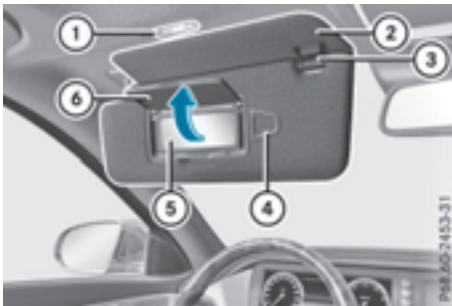

- ① Mirror light
- ② Additional sun visor
- ③ Bracket
- ④ Retaining clip, e.g. for a car park ticket
- ⑤ Vanity mirror
- ⑥ Mirror cover

### Vanity mirror in the sun visor

Mirror light ① only functions if the sun visor is clipped into retainer ③ and mirror cover ⑥ has been folded up.

### Glare from the side

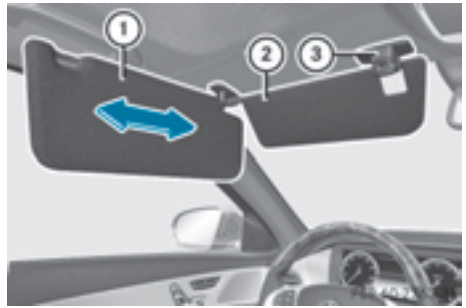

- ▶ Fold down sun visor ①.
- ▶ Pull sun visor ① out of bracket ③.
- ▶ Swing sun visor ① to the side.
- ▶ Slide sun visor ① horizontally as required.
- ▶ Fold down additional sun visor ② to the windshield.

### Rear side window roller sunblinds



- ① Front left
- ② Front right
- ③ Rear right
- ④ Rear left

The sunblinds for the rear side windows can be operated with the buttons for the side windows. The switches for all side windows are located on the driver's door. There is also a switch on each door for the corresponding side window.

The switches on the driver's door take precedence.

- ▶ **To close fully:** pull the corresponding switch when the side window is closed.
- ▶ **To open fully:** press the corresponding switch.

- i** You can use the switches on the rear doors to close the rear roller sunblinds for the opposite side.

### Rear window roller sunblind

#### Important safety notes

##### WARNING

Parts of the body could be trapped in the sweep of the roller sunblind when the roller sunblind is extended or retracted. There is a risk of injury.

When extending or retracting make sure that no parts of the body are in the sweep of the roller sunblind. Briefly press the button again if someone becomes trapped. The opening or closing process is briefly stopped. The roller sunblind then returns to its initial position.

- !** Make sure that the roller sunblind can move freely. Otherwise, the roller sunblind or other objects could be damaged.

At temperatures below -4 °F (-20 °C) the roller sunblind cannot be operated.

#### Extending/retracting from the driver's seat



- ▶ Turn the SmartKey to position 1 or 2 in the ignition lock (▷ page 162).
- ▶ **To extend or retract:** briefly press button ①. The roller sunblind fully extends or fully retracts.
- ▶ **To stop:** briefly press button ① again. The roller sunblind stops briefly and moves back into the out-of-use position.

#### Extending/retracting from the rear

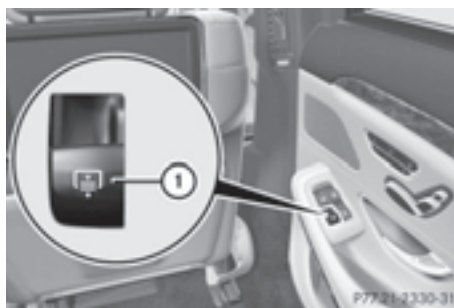

- ▶ Turn the SmartKey to position 1 or 2 in the ignition lock (▷ page 162).
- ▶ **To extend:** pull switch ① upwards and let go. The roller sunblind extends fully.
- ▶ **To stop extending:** press switch ① downwards briefly. The roller sunblind stops briefly and then retracts again.
- ▶ **To retract:** press switch ① beyond the point of resistance and let go. The roller sunblind retracts fully.
- ▶ **To stop retracting:** pull switch ① upwards. The roller sunblind stops briefly and then extends again.

When the override feature for the rear side windows is activated (▷ page 67), the  switch cannot be operated. The roller sunblind can only be extended and retracted from the driver's seat.

### Ashtray

#### Front ashtray





- ▶ **To open:** briefly press marking ④. Stowage compartment ③ opens.
- ▶ **To remove the insert:** grip the sides of insert ①, push it forward and pull it upwards ②.
- ▶ **To re-install the insert:** press insert ① into the drawer until it engages.
- ▶ **To close:** press stowage compartment ③ closed until it locks.

### Rear-compartment ashtray



The ashtray is located in the stowage compartment in the rear door. To use it, you can place it in a cup holder or hold it in your hand.

- ▶ Remove the ashtray from retainer ① in the rear door.
- ▶ **To open:** fold lid ② upwards.
- ▶ **To close:** press lid ② downwards.

If you are not using the ashtray, close it and place it in the retainer in the rear door.

### Cigarette lighter

#### Important safety notes

#### WARNING

You can burn yourself if you touch the hot heating element or the socket of the cigarette lighter.

In addition, flammable materials can ignite if:

- the hot cigarette lighter falls
- a child holds the hot cigarette lighter to objects, for example

There is a risk of fire and injury.

Always hold the cigarette lighter by the knob. Always make sure that the cigarette lighter is out of reach of children. Never leave children unsupervised in the vehicle.

Your attention must always be focused on the traffic conditions. Only use the cigarette lighter when road and traffic conditions permit.

### Cigarette lighter in the front compartment



- ▶ Turn the SmartKey to position 2 in the ignition lock (> page 162).
- ▶ **To open:** briefly press marking ③. Stowage compartment ② opens.
- ▶ Press in cigarette lighter ①. Cigarette lighter ① will pop out automatically when the heating element is red-hot.
- ▶ **To close:** press stowage compartment ② closed until it locks.

### Cigarette lighter in the rear compartment

#### Vehicles with a rear bench seat or electrically adjustable rear seats



Vehicles without a Rear Seat Entertainment System

- ▶ Turn the SmartKey to position **2** in the ignition lock (> page 162).
- ▶ **To open:** briefly press cover **②** at the top. The compartment opens.
- ▶ Press in cigarette lighter **①**. Cigarette lighter **①** will pop out automatically when the heating element is red-hot.
- ▶ **To close:** press cover **②** closed until it locks.



Vehicles with a Rear Seat Entertainment System:

- ▶ Turn the SmartKey to position **2** in the ignition lock (> page 162).
- ▶ **To open:** briefly press cover **②** at the top. The compartment opens.
- ▶ Press in cigarette lighter **①**. Cigarette lighter **①** will pop out automatically when the heating element is red-hot.
- ▶ **To close:** press cover **②** closed until it locks.

Vehicles with individual seats in the rear

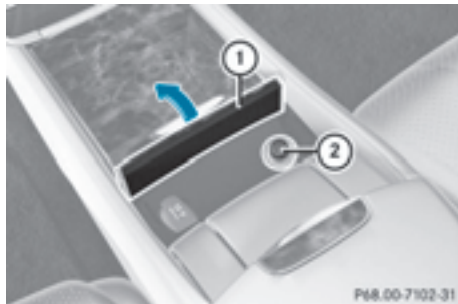

Example: Sedan

- ▶ Press lid **①** of the socket compartment briefly. The socket compartment opens.
- ▶ Press in cigarette lighter **②**. Cigarette lighter **②** will pop out automatically when the heating element is red-hot.

## 12 V sockets

### General notes

- ▶ Turn the SmartKey to position **1** in the ignition lock (> page 162).

The sockets can be used for accessories with a maximum draw of 180 W (15 A). Accessories include such items as chargers for mobile phones.

If you use the sockets for long periods when the engine is switched off, the battery may discharge.

An emergency cut-out ensures that the on-board voltage does not drop too low. If the on-board voltage is too low, the power to the sockets is automatically cut. This ensures that there is sufficient power to start the engine.

### Socket in the front-compartment center console

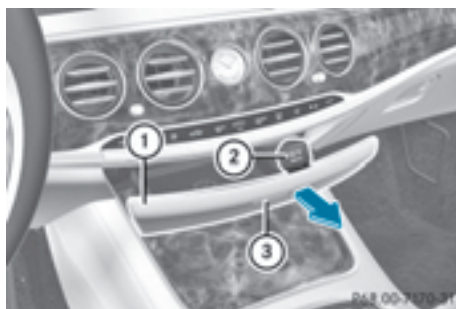

- ▶ **To open:** briefly press marking **③**. Stowage compartment **①** opens.
- ▶ Lift up the cover of socket **②**.
- ▶ **To close:** press stowage compartment **①** closed until it locks.

### Socket in the rear compartment

#### Vehicles with a rear bench seat or electrically adjustable rear seats



Vehicles without a Rear Seat Entertainment System

- ▶ **To open:** briefly press cover (2) at the top. The compartment opens.
- ▶ Lift up the cover of socket (1).
- ▶ **To close:** press cover (2) closed until it locks.



Vehicles with a Rear Seat Entertainment System:

- ▶ **To open:** briefly press cover (2) at the top. The compartment opens.
- ▶ Lift up the cover of socket (1).
- ▶ **To close:** press cover (2) closed until it locks.

On vehicles with a 115 V socket, there is no 12 V socket in the center console in the rear compartment.

### Vehicles with individual seats in the rear



Example: Sedan

- ▶ Press lid (1) of the socket compartment briefly. The socket compartment opens.
- ▶ Lift up the cover of socket (2).

### Socket in the trunk



- ▶ Lift up the cover of socket (1).

### 115 V socket

#### Important safety notes

#### DANGER

When a suitable device is connected, the 115 V power socket will be carrying a high voltage. You could receive an electric shock if the connector cable or the 115 V power socket is pulled out of the trim or is damaged or wet. There is a risk of fatal injury.

- Use only connector cables that are dry and free of damage.
- When the ignition is off, make sure that the 115 V power socket is dry.
- Have the 115 V power socket checked or replaced immediately at a qualified specialized workshop if it is damaged or has been pulled out of the trim.
- Never plug the connector cable into a 115 V power socket that is damaged or has been pulled out of the trim.

### DANGER

If you reach into the power socket or plug inappropriate devices into the power socket, you could receive an electric shock. There is a risk of fatal injury.

Only connect appropriate devices to the power socket.

- ❗ Note that work and repairs on the 115 V power socket should only be carried out by qualified specialist personnel.

### General notes

The 115 V power socket provides an alternating voltage of 115 V so that small electronic devices can be connected. These devices, such as games consoles, chargers and laptops, must not consume more than a maximum of 150 watts altogether.

Requirements for operation of these devices:

- the electronic device that you connect has a suitable connector and conforms to standards specific to the country you are in.
- the plug of the electronic device is plugged correctly into 115 V power socket.
- the maximum wattage of the device to be connected must not exceed 150 watts.
- the on-board power supply is within a permissible voltage range.
- the 12 V sockets in the center console in the front compartment (▷ page 336) and in the trunk are functional (▷ page 337).

### Using the 115 V power socket



The 115 V socket is in the center console in the rear compartment on vehicles with a rear bench seat or electrically adjustable rear seats.

- ▶ **To switch on:** switch the ignition on.
- ▶ Open flap ③.
- ▶ Insert the plug of the electronic device into 115 V power socket ①. Indicator lamp ② lights up.
- ▶ **To switch off:** remove the connector from 115 V socket ①. Ensure that you do not pull on the cord.



The 115 V socket is in the armrest on vehicles with individual seats in the rear.

- ▶ Open the armrest (▷ page 327).
- ▶ **To switch on:** switch the ignition on.
- ▶ Open flap ③.
- ▶ Insert the plug of the electronic device into 115 V power socket ①. Indicator lamp ② lights up.
- ▶ **To switch off:** remove the connector from 115 V socket ①. Ensure that you do not pull on the cord.

## Problems with the 115 V power socket

Problem	Possible causes/consequences and ► Solutions
The warning lamp on the 115 V power socket is not lit.	The on-board voltage is too low because the battery is too weak. <ul style="list-style-type: none"> <li>► Start the engine.</li> </ul> or <ul style="list-style-type: none"> <li>► Charge the battery (▷ page 374).</li> </ul> If the indicator lamp still does not light up: <ul style="list-style-type: none"> <li>► Visit a qualified specialist workshop.</li> </ul>
	The temperature of the DC/AC converter is temporarily too high. <ul style="list-style-type: none"> <li>► Remove the electronic device connector from the 115 V socket.</li> <li>► Let the DC/AC converter cool down.</li> </ul>
	If the indicator lamp still does not light up after cooling down the converter: <ul style="list-style-type: none"> <li>► Visit a qualified specialist workshop.</li> </ul>
	You have connected an electronic device that has a constant nominal power of less than 150 watts, but has a very high switch-on current. This device will not work. If you connect such a device, the 115 V power socket will not supply it with power. <ul style="list-style-type: none"> <li>► Connect a suitable electronic device.</li> </ul>

### Coolbox in the rear compartment

#### Important safety notes

 **WARNING**

If you cover the ventilation grille for the coolbox, it may overheat. There is a risk of fire. Always make sure that the ventilation grille is not covered.

The ventilation grille for the coolbox is in the trunk.

The coolbox can bear a maximum load of 7.7 lb (3.5 kg).

If you want to store a bottle in the upper compartment of the coolbox, the capacity of the bottle must not exceed 17 fl. oz. (0.5 l).

Store only plastic bottles in the upper compartment of the coolbox.

### Using the coolbox



- **Vehicles with rear seat armrest:** fold down the rear seat armrest.
- Pull handle ① and fold down cover ②.



- ▶ **To open:** pull handle ① on the cover.
- ▶ Fold the cover out to the front.
- ▶ **To switch cooling level to low:** press button ② once. An indicator lamp in the button lights up.
- ▶ **To switch cooling level to high:** press button ② twice. Both indicator lamps in the button light up.
- ▶ **To switch off cooling:** press button ② repeatedly until the indicator lamps go out.

The cooling output of the coolbox depends on the ambient temperature and the selected cooling level.

The coolbox reduces its cooling output or switches off, if:

- many electrical consumers are turned on
- the starter battery is not sufficiently charged

This is indicated by the flashing indicator lamps in the button. The cooling function will automatically switch back on as soon as there is sufficient voltage.

### Caring for the coolbox

If you do not need to use the coolbox for an extended period you should switch it off, defrost it and clean it. After doing so, leave the lid open for a time.

### Removing and installing the coolbox

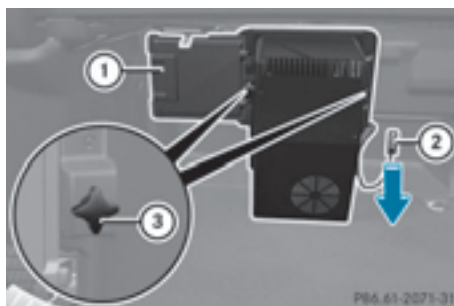

You can remove the coolbox for maintenance purposes.

- ▶ **To remove:** switch off the coolbox.
- ▶ Pull plug ② down and out.
- ▶ Unscrew both screws ③.
- ▶ Pull out the coolbox.
- ▶ Close flap ①.
- ▶ **To install:** swing flap ① to the side until it is locked in place by the magnets.
- ▶ Insert the coolbox.
- ▶ Tighten both screws ③.
- ▶ Connect plug ②.

### mbrace

#### General notes

The mbrace system is only available in the USA. You must have a license agreement to activate the mbrace service. Make sure that your system is activated and operational. To log in, press the  MB Info call button. If any of the steps mentioned are not carried out, the system may not be activated.

If you have questions about the activation, contact one of the following telephone hotlines: Mercedes-Benz Customer Assistance Center at 1-800-FOR-MERcedes (1-800-367-6372) or 1-866-990-9007

Shortly after successfully registering with the mbrace service, a user ID and password will be sent to you by mail. You can use this password to log onto the mbrace area under "Owners Online" at <http://www.mbusa.com>.

The system is available if:

- it has been activated and is operational
- the corresponding mobile phone network is available for transmitting data to the Customer Center
- a service subscription is available

Determining the location of the vehicle on a map is only possible if:

- GPS reception is available.
- the vehicle position can be forwarded to the Customer Assistance Center.

## The mbrace system

To adjust the volume during a call, proceed as follows:

- ▶ Press the  or  button on the multi-function steering wheel.

or

- ▶ Use the volume control on the multimedia system.

The system offers various services, e.g.:



- Automatic and manual emergency call
- Roadside Assistance call
- MB Info call



You can find information and a description of all available features under "Owners Online" at <http://www.mbusa.com>.

## System self-test

After you have switched on the ignition, the system carries out a self-diagnosis.

A malfunction in the system has been detected if one of the following occurs:

- The indicator lamp in the SOS button does not come on during the system self-test.
- The indicator lamp in the  Roadside Assistance button does not light up during self-diagnosis of the system.
- The indicator lamp in the  MB Info call button does not light up during self-diagnosis of the system.

- The indicator lamp in one or more of the following buttons continues to light up red after the system self-diagnosis:
  - SOS button
  -  Roadside Assistance call button
  -  MB Info call button
- The **Inoperative** or the **Service Not Activated** message appears in the multi-function display after the system self-diagnosis.

If a malfunction is indicated as outlined above, the system may not operate as expected. In the event of an emergency, help will have to be summoned by other means.

Have the system checked at the nearest authorized Mercedes-Benz Center or contact the following service hotlines:

Mercedes-Benz Customer Assistance Center at 1-800-FOR-MERCEdes (1-800-367-6372) or 1-866-990-9007

## Emergency call

### Important safety notes

#### WARNING

It can be dangerous to remain in the vehicle, even if you have pressed the SOS button in an emergency if:

- you see smoke inside or outside of the vehicle, e.g. if there is a fire after an accident
- the vehicle is on a dangerous section of road
- the vehicle is not visible or cannot easily be seen by other road users, particularly when dark or in poor visibility conditions

There is a risk of an accident and injury.

Leave the vehicle immediately in this or similar situations as soon as it is safe to do so. Move to a safe location along with other vehicle occupants. In such situations, secure the vehicle in accordance with national regulations, e.g. with a warning triangle.

### General notes

Observe the notes on system activation (▷ page 340).

An emergency call is dialed automatically if an air bag or Emergency Tensioning Device is trig-

gered. You cannot end an automatically triggered emergency call yourself.

An emergency call can also be initiated manually.

As soon as the emergency call has been initiated, the indicator lamp in the SOS button flashes. The **Connecting Call** message appears in the multifunction display.

The audio output is muted.

Once the connection has been made, the **Call Connected** message appears in the multifunction display.

All important information on the emergency is transmitted, for example:

- current location of the vehicle (as determined by the GPS system)
- vehicle identification number
- information on the severity of the accident

Shortly after the emergency call has been initiated, a voice connection is automatically established between the Customer Assistance Center and the vehicle occupants.

- If the vehicle occupants respond, the Mercedes-Benz Customer Assistance Center attempts to get more information on the emergency.
- If there is no response from the vehicle occupants, an ambulance is immediately sent to the vehicle.

If no voice connection can be established to the Mercedes-Benz Customer Assistance Center, the system has been unable to initiate an emergency call.

This can occur, for example, if the relevant mobile phone network is not available. The indicator lamp in the SOS button flashes continuously.

The **Call Failed** message appears in the multifunction display and must be confirmed.

In this case, summon assistance by other means.

## Making an emergency call



- ▶ **To initiate an emergency call manually:** press cover ① briefly to open.
- ▶ Press and hold the SOS button for at least one second ②. The indicator lamp in SOS button ② flashes until the emergency call is concluded.
- ▶ Wait for a voice connection to the Mercedes-Benz Customer Assistance Center.
- ▶ After the emergency call, close cover ①.

If the mobile phone network is unavailable, mbrace will not be able to make the emergency call. If you leave the vehicle immediately after pressing the SOS button, you will not know whether mbrace placed the emergency call. In this case, always summon assistance by other means.

## Roadside Assistance button



- ▶ **To call Roadside Assistance:** press Roadside Assistance button ①. This initiates a call to the Mercedes-Benz Customer Assistance Center. The indicator lamp in Roadside Assistance button ① flashes while the call is active. The **Connecting Call** message appears in the



multifunction display. The audio output is muted.

If a connection can be made, the **Call Connected** message appears in the multifunction display.

If a mobile phone network and GPS reception are available, the system transfers data to the Mercedes-Benz Customer Assistance Center, for example:

- current location of the vehicle
- vehicle identification number

The multimedia system display indicates that a call is active. During the call, you can change to the navigation menu by pressing the NAVI button on the multimedia system, for example.

Voice output is not available in this case.

A voice connection is established between the Mercedes-Benz Customer Assistance Center and the vehicle occupants.

From the remote malfunction diagnosis, the Mercedes-Benz Customer Assistance Center can ascertain the nature of the problem (▷ page 346).

The Mercedes-Benz Customer Assistance Center either sends a qualified Mercedes-Benz technician or makes arrangements for your vehicle to be transported to the nearest authorized Mercedes-Benz Center.

You may be charged for services such as repair work and/or towing.

You can find more information in the separate mbrace manual.

The system has not been able to initiate a Roadside Assistance call, if:

- the indicator lamp for Roadside Assistance call button  is flashing continuously.
- no voice connection to the Mercedes-Benz Customer Assistance Center was established.

This can occur if the relevant mobile phone network is not available, for example.

The **Call Failed** message appears in the multifunction display.

► **To end a call:** press the  button on the multifunction steering wheel.

or

► Press the corresponding multimedia system button for ending a phone call.

## MB Info call button



► **To call MB Info:** press MB Info call button ①. This initiates a call to the Mercedes-Benz Customer Assistance Center.

The indicator lamp in MB Info call button ① flashes while the connection is being made. The **Connecting Call** message appears in the multifunction display. The audio output is muted.

If a connection can be made, the **Call Connected** message appears in the multifunction display.

If a mobile phone network and GPS reception are available, the system transfers data to the Mercedes-Benz Customer Assistance Center, for example:

- current location of the vehicle
- vehicle identification number

The multimedia system display indicates that a call is active. During the call, you can change to the navigation menu by pressing the NAVI button on COMAND, for example.

Voice output is not available in this case.

A voice connection is established between the Mercedes-Benz Customer Assistance Center and the vehicle occupants.

You receive information about operating your vehicle, about the nearest authorized Mercedes-Benz Center and about other products and services from Mercedes-Benz.

You can find further information on the mbrace system under "Owners Online" at <http://www.mbusa.com>.

The system has not been able to initiate an MB Info call, if:

- the indicator lamp in MB Info call button  is flashing continuously.
- no voice connection to the Mercedes-Benz Customer Assistance Center was established.

This can occur if the relevant mobile phone network is not available, for example.

The **Call Failed** message appears in the multifunction display.

► **To end a call:** press the  button on the multifunction steering wheel.

or

► Press the corresponding multimedia system button for ending a phone call.

### Call priority

When service calls are active, e.g. Roadside Assistance or MB Info calls, an emergency call can still be initiated. In this case, an emergency call will take priority and override all other active calls.

The indicator lamp of the respective button flashes until the call is ended.

An emergency call can only be terminated by the Mercedes-Benz Customer Assistance Center.

All other calls can be ended by pressing:

- the  button on the multifunction steering wheel
- the corresponding button in the multimedia system to end the voice call

When a call is initiated, the audio system is muted.

The mobile phone is no longer connected to the multimedia system.

However, if you want to use your mobile phone, do so only when the vehicle is stationary and in a safe location.

### Downloading destinations



#### Downloading destinations

Downloading destinations gives you access to a database with over 15 million points of interest (POIs). These can be downloaded on the navigation system in your vehicle. If you know the destination, the address can be downloaded. Alternatively, you can obtain the location of

Points of Interest (POIs)/important destinations in the vicinity.

Furthermore, you can download routes with up to four way points.

You are prompted to confirm route guidance to the address entered.

► Select **Yes** by turning  or sliding  the controller and confirm with .

The system calculates the route and subsequently starts the route guidance with the address entered.

If you select **No** the address can be stored in the address book.

The destination download function is available if:

- the vehicle is equipped with a navigation system.
- the relevant mobile phone network is available and data transfer is possible.

### Route Assistance

This service is part of the mbrace PLUS Package and cannot be purchased separately.

You can use the route assistance function even if the vehicle is not equipped with a navigation system.

Within the framework of this service, you receive a professional and reliable form of navigation support without having to leave your vehicle.

The customer service representative finds a suitable route depending on your vehicle's current position and the desired destination. You will then be guided live through the current route section.

### Search & Send

#### General notes

To use "Search & Send", your vehicle must be equipped with mbrace and a navigation system. Additionally, an mbrace service subscription must be completed.

"Search & Send" is a destination entry service. A destination address which is found on Google Maps® can be transferred via mbrace directly to your vehicle's navigation system.

## Specifying and sending the destination address

- ▶ Go to the website <http://maps.google.com> and enter a destination address into the entry field.
- ▶ **To send the destination address to the e-mail address of your mbrace account:** click on the corresponding button on the website.



Example:

If you select 'Send to vehicle' and then 'Mercedes-Benz', the destination address will be sent to your vehicle.

- ▶ When the "Send" dialog window appears: Enter the e-mail address you specified when setting up your mbrace account into the corresponding field.
- ▶ Click "Send".

Information on specific commands such as "Address entry" or "Send" can be found on the website.

## Calling up a transmitted destination address

- ▶ Turn the SmartKey to position **2** in the ignition lock (▷ page 162). The transmitted destination address is loaded into the vehicle's navigation system. A display message appears, asking whether navigation should be started.
- ▶ Select **Yes** by turning  or sliding  the controller and confirm with . The system calculates the route and subsequently starts the route guidance with the address entered.

If you select **No** the address can be stored in the address book.

If you have sent more than one destination address, each individual destination must be confirmed separately.

Destination addresses are loaded in the same order as the order in which they were sent.

If you own multiple Mercedes-Benz vehicles with mbrace and activated mbrace accounts:

If multiple vehicles are registered under the same e-mail address, the destination will be sent to all the vehicles.

## Vehicle remote opening

You can use the vehicle remote opening if you have unintentionally locked your vehicle and a replacement SmartKey is not available.

The vehicle can be opened by the Mercedes-Benz Customer Assistance Center.

The vehicle can be immediately opened remotely within four days of the ignition being turned off. After this time, the remote unlocking may be delayed by 15 to 60 minutes. After 30 days, the vehicle can no longer be opened remotely.

The vehicle remote unlocking feature is available if the relevant mobile phone network is available and a data connection is possible.

- ▶ Contact the following service hotlines: Mercedes-Benz Customer Assistance Center at 1-800-FOR-MERCEdes (1-800-367-6372) or 1-866-990-9007  
You will be asked for your password.
- ▶ Return to your vehicle at the time agreed upon with the Mercedes-Benz Customer Assistance Center.

Alternatively, the vehicle can be opened via:

- the Internet, under the "Owners Online" section
- the telephone application (e.g. for iPhone®, Android)

To do this, you will need your identification number and password.

## Vehicle remote closing

The vehicle remote-closing feature can be used when you have forgotten to lock the vehicle and you are no longer nearby.

The vehicle can then be locked by the Mercedes-Benz Customer Assistance Center.

The vehicle can be immediately remotely locked within four days of the ignition being turned off. After this time, remote closing may be delayed by 15 to 60 minutes. After 30 days the vehicle can no longer be locked remotely.

The vehicle remote closing feature is available if the relevant mobile phone network is available and a data connection is possible.

- ▶ Contact the following service hotlines:

Mercedes-Benz Customer Assistance Center at 1-800-FOR-MERcedes (1-800-367-6372) or 1-866-990-9007

You will be asked for your password.

The next time you are inside the vehicle and you switch on the ignition, the **Doors Locked Remotely** message appears in the multifunction display.

Alternatively, the vehicle can be locked via:

- the Internet, under the "Owners Online" section
- the telephone application (e.g. for iPhone®, Android)

To do this, you will need your identification number and password.

### Stolen vehicle recovery service

If your vehicle has been stolen:

- ▶ Notify the police.  
The police will issue a numbered incident report.
- ▶ This number will be forwarded to the Mercedes-Benz Customer Assistance Center together with your PIN.  
The Mercedes-Benz Customer Assistance Center then tries to locate the system. The Mercedes-Benz Customer Assistance Center contacts you and the local law enforcement agency if the vehicle is located.  
However, only the law enforcement agency is informed of the location of the vehicle.

If the anti-theft alarm system is activated for longer than 30 seconds, the Mercedes-Benz Customer Assistance Center is automatically notified.

### Vehicle Health Check

With the Vehicle Health Check, the Customer Assistance Center can provide improved support for problems with your vehicle. During an existing call, vehicle data is transferred to the Customer Assistance Center.

The customer service representative can use the received data to decide what kind of assistance is required. You are then, for example, guided to the nearest authorized Mercedes-Benz Center or a recovery vehicle is called.

If vehicle data needs to be transferred during an MB Info call or a Roadside Assistance call, this is initiated by the Customer Assistance Center.

The **Roadside Assistance Connected** message appears in the display. If the Vehicle Health Check can be started, the **Request for Vehicle Diagnostics Received Start vehicle diagnostics?** message appears in the display.

- ▶ Press the **Yes** button to confirm the message.
- ▶ When the **Vehicle Diagnostics Please Start Ignition** message appears: turn the SmartKey to position **2** in the Ignition lock (▷ page 162).
- ▶ If the **Please follow the instructions received by phone and move your vehicle to a safe position.** message appears: please follow the instructions received by phone and move your vehicle to a safe position.  
The message in the display disappears.  
The vehicle operating state check begins. During this procedure, you will see the **Vehicle Diagnostics Active** message.  
If you select **Cancel**, the Vehicle Health Check is canceled completely.

When the check is complete, the **Sending vehicle diagnostics data. (Voice connection may be interrupted during data transfer)** message appears. The vehicle data can now be sent.

- ▶ Press the **OK** button to confirm the message.  
The voice connection with the Customer Assistance Center is terminated.  
The **Vehicle Diagnostics: Transferring Data...** message appears.  
The vehicle data is sent to the Customer Assistance Center.

Depending on what the customer service representative agreed with you, the voice connection is re-established after the transfer is complete. If necessary, you will be contacted at a later time by another means, e.g. by e-mail or phone.

Another function of the Vehicle Health Check is the transfer of service data to the Customer Assistance Center. If a service is due, the display shows a message to this effect together with information about any special offers at your workshop.

This information can also be called up under "Owners Online" at <http://www.mbusa.com>. Information on the data stored in the vehicle (▷ page 29).

Information on Roadside Assistance  
(▷ page 26).

## Downloading routes

Downloading routes allows you to transfer and save predefined routes in the navigation system.

A route can be prepared and sent by either a customer service representative or under "Owners Online" at <http://www.mbusa.com>.

Each route can include up to four way points.

Once a route has been received by the navigation system, you will see the **External destination ICON POI Category Name\_1 has been saved to "Previous destinations". Would you like to start navigation?** message on the multimedia system display.

The route is saved.

► **To start route guidance:** select **Yes**.

An overview of the route is shown in the display.

If you select **No**, the saved route can be called up later in the navigation menu.

► Select **Start**.

Starting route guidance.

Downloaded and saved routes can be called up again.

You can find further information in the separate multimedia system operating instructions.

## Speed alert

You can define the upper speed limit, which must not be exceeded by the vehicle.

If this selected speed is exceeded by the vehicle, a message will be sent to the Customer Assistance Center. The Customer Assistance Center then forwards this information to you.

You can select the way in which you receive this information beforehand. Possible options include text message, e-mail or an automated call.

The data you receive contains the following information:

- the location where the speed limit was exceeded
- the time at which the speed limit was exceeded
- the selected speed limit which was exceeded

## Geo fencing

Geo fencing allows you to select areas which the vehicle should not enter or leave. You will be informed if the vehicle crosses the boundaries of the selected areas. You can select the way in which you receive this information beforehand. Possible options include text message, e-mail or an automated call.

The area can be determined as either a circle or a polygon with a maximum of ten corners. You can specify up to ten areas simultaneously. Different settings are possible for each area.

These settings can be called up under "Owners Online" at <http://www.mbusa.com>.

Alternatively, you can trigger an MB Info call and inform the customer service representative that you wish to activate geo fencing.

Currently inactive areas can be activated by text message.

## Triggering the vehicle alarm

With this function, you can trigger the vehicle's panic alarm via text message. An alarm sounds and the exterior lighting flashes. Depending on the setting, the panic alarm lasts five or ten seconds. Afterwards, the alarm switches off.

## Garage door opener

### General notes

The HomeLink® garage door opener integrated in the rear-view mirror allows you to operate up to three different door and gate systems.

Use the integrated garage door opener only on garage doors that:

- have safety stop and reverse features and
- meet current U.S. federal safety standards

Once programmed, the integrated garage door opener in the rear-view mirror will assume the function of the garage door system's remote control. Please also read the operating instructions for the garage door system.

When programming a garage door opener, park the vehicle outside the garage. Do not run the engine while programming.

Certain garage door drives are incompatible with the integrated garage door opener. If you have difficulty programming the integrated garage

door opener, contact an authorized Mercedes-Benz Center.

Alternatively, you can call the following telephone assistance services:

- **USA:** Mercedes-Benz Customer Assistance Center at 1-800-FOR-MERCEdes
- **Canada:** Customer Service at 1-800-387-0100
- HomeLink® hotline 1-800-355-3515 (free of charge)

More information on HomeLink® and/or compatible products is also available online at <http://www.homelink.com>.

Notes on the declaration of conformity (▷ page 28).

USA: FCC ID: CB2HMIHL4

Canada: IC: 279B-HMIHL4

## Important safety notes

### WARNING

When you operate or program the garage door with the integrated garage door opener, persons in the range of movement of the garage door can become trapped or struck by the garage door. There is a risk of injury.

When using the integrated garage door opener, always make sure that nobody is within the range of movement of the garage door.

### WARNING

Combustion engines emit poisonous exhaust gases such as carbon monoxide. Inhaling these exhaust gases leads to poisoning. There is a risk of fatal injury. Therefore never leave the engine running in enclosed spaces without sufficient ventilation.

## Programming

### Programming buttons

Pay attention to the "Important safety notes" (▷ page 348).

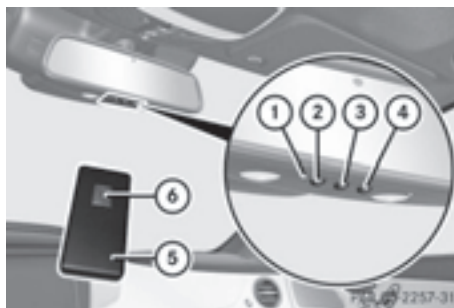

Garage door remote control ⑤ is not included with the integrated garage door opener.

- ▶ Turn the SmartKey to position **2** in the ignition lock (▷ page 162).
- ▶ Select one of buttons ② to ④ to use to control the garage door drive.

- ▶ **To start programming mode:** press and hold one of buttons ② to ④ on the integrated garage door opener.

The garage door opener is now in programming mode. After a short time, indicator lamp ① lights up yellow.

Indicator lamp ① lights up yellow as soon as button ②, ③ or ④ is stored for the first time. If the selected button has already been programmed, indicator lamp ① will only light up yellow after ten seconds have elapsed.

- ▶ Release button ②, ③ or ④. Indicator lamp ① flashes yellow.
- ▶ **To program the remote control:** point garage door remote control ⑤ towards buttons ② to ④ on the rear-view mirror at a distance of 2 to 8 in (5 to 20 cm).
- ▶ Press and hold button ⑥ on remote control ⑤ until indicator lamp ① lights up green. When indicator lamp ① lights up green: programming is finished. When indicator lamp ① flashes green: programming was successful. The next step is to synchronize the rolling code (▷ page 349).
- ▶ Release button ⑥ on remote control ⑤ for the garage door drive system. If indicator lamp ① lights up red: repeat the programming procedure for the corresponding button on the rear-view mirror. When doing so, vary the distance between remote control ⑤ and the rear-view mirror.

The required distance between remote control ⑤ and the integrated garage door opener depends on the garage door drive system.

Several attempts might be necessary. You should test every position for at least 25 seconds before trying another position.

### Synchronizing the rolling code

Pay attention to the "Important safety notes" (▷ page 348).

If the garage door system uses a rolling code, you will also have to synchronize the garage door system with the integrated garage door opener in the rear-view mirror. To do this you will need to use the programming button on the door drive control panel. The programming button may be located in different places depending on the manufacturer. It is usually located on the door drive unit on the garage ceiling.

Familiarize yourself with the garage door drive operating instructions, e.g. under "Programming additional remote controls", before carrying out the following steps.

Your vehicle must be within reach of the garage door or gate opener drive. Make sure that neither your vehicle nor any persons/objects are present within the sweep of the door or gate.

- ▶ Turn the SmartKey to position **2** in the ignition lock (▷ page 162).
- ▶ Get out of the vehicle.
- ▶ Press the programming button on the door drive unit.  
Usually, you now have 30 seconds to initiate the next step.
- ▶ Get into the vehicle.
- ▶ Press previously programmed button **②**, **③** or **④** on the integrated garage door opener repeatedly and in quick succession until the door closes.  
The rolling code synchronization is then complete.

### Notes on programming the remote control

Canadian radio frequency laws require a "break" (or interruption) of the transmission signals after broadcasting for a few seconds. Therefore, these signals may not last long enough for the integrated garage door opener. The signal is not recognized during programming. Comparable with Canadian law, some U.S. garage door openers also feature a "break".

Proceed as follows:

- if you live in Canada
- if you have difficulties programming the garage door opener (regardless of where you live) when using the programming steps
- ▶ Press and hold one of buttons **②** to **④** on the integrated garage door opener.  
After a short time, indicator lamp **①** lights up yellow.
- ▶ Release the button.  
Indicator lamp **①** flashes yellow.
- ▶ Press button **⑥** of garage door remote control **⑤** for two seconds, then release it for two seconds.
- ▶ Press button **⑥** again for two seconds.
- ▶ Repeat this sequence on button **⑥** of remote control **⑤** until indicator lamp **①** lights up green.  
When indicator lamp **①** lights up green: programming is finished.  
When indicator lamp **①** flashes green: programming was successful. The next step is to synchronize the rolling code.
- ▶ Release button **⑥** of remote control **⑤** of the garage door drive.  
If indicator lamp **①** lights up red: repeat the programming process for the corresponding button on the rear-view mirror. When doing so, vary the distance between remote control **⑤** and the rear-view mirror.  
The required distance between remote control **⑤** and the integrated garage door opener depends on the garage door drive system. Several attempts might be necessary. You should test every position for at least 25 seconds before trying another position.

### Problems when programming

If you are experiencing problems programming the integrated garage door opener on the rear-view mirror, take note of the following instructions:

- Check the transmitter frequency used by garage door drive remote control **⑤** and whether it is supported. The transmitter frequency can usually be found on the back of the garage door drive remote control.  
The integrated garage door opener is compatible with devices that have units which

operate in the frequency range of 280 to 433 MHz.

- Replace the batteries in garage door remote control ⑤. This increases the likelihood that garage door remote control ⑤ will transmit a strong and precise signal to the integrated garage door opener.
- When programming, hold remote control ⑤ at varying distances and angles from the button which you are programming. Try various angles at a distance between 2 and 12 inches (5 to 30 cm) or at the same angle but at varying distances.
- If another remote control is available for the same garage door drive, repeat the same programming steps with this remote control. Before performing these steps, make sure that new batteries have been installed in garage door drive remote control ⑤.
- Note that some remote controls only transmit for a limited amount of time (the indicator lamp on the remote control goes out). Press button ⑥ on remote control ⑤ again before transmission ends.
- Align the antenna cable of the garage door opener unit. This can improve signal reception/transmission.

### Opening/closing the garage door

After it has been programmed, the integrated garage door opener performs the function of the garage door system remote control. Please also read the operating instructions for the garage door system.

- ▶ Turn the SmartKey to position **2** in the ignition lock (> page 162).
  - ▶ Press button ②, ③ or ④ which you have programmed to operate the garage door.
    - Garage door system with a fixed code: indicator lamp ① lights up green.
    - Garage door system with a rolling code: indicator lamp ① flashes green.
- The transmitter will transmit a signal as long as the button is pressed. The transmission is halted after a maximum of ten seconds and indicator lamp ① lights up yellow.
- ▶ Press button ②, ③ or ④ again if necessary.

### Clearing the memory

Make sure that you clear the memory of the integrated garage door opener before selling the vehicle.

- ▶ Turn the SmartKey to position **2** in the ignition lock (> page 162).
- ▶ Press and hold buttons ② and ④. The indicator lamp initially lights up yellow and then green.
- ▶ Release buttons ② and ④. The memory of the integrated garage door opener in the rear-view mirror is cleared.

### Floormats

#### ⚠ WARNING

Objects in the driver's footwell can restrict the pedal travel or obstruct a depressed pedal. The operating and road safety of the vehicle is jeopardized. There is a risk of an accident.

Make sure that all objects in the vehicle are stowed correctly, and that they cannot enter the driver's footwell. Install the floormats securely and as specified in order to ensure sufficient clearance for the pedals. Do not use loose floormats and do not place floormats on top of one another.

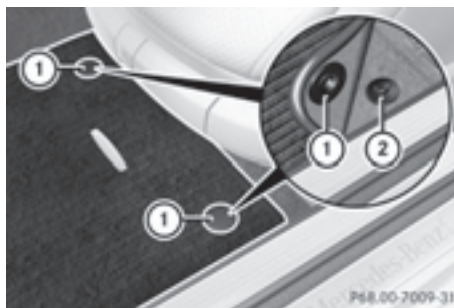

- ▶ **Driver's seat/front-passenger seat:** slide the respective seat back.
- ▶ **Rear seats:** slide the corresponding front seat forwards.
- ▶ **To install:** place the floormat in the footwell.
- ▶ Press studs ① onto retainers ② until you hear them engage.



- ▶ **To remove:** pull the floormat from retainers ②.
- ▶ Remove the floormat.

### Infrared reflective windshield

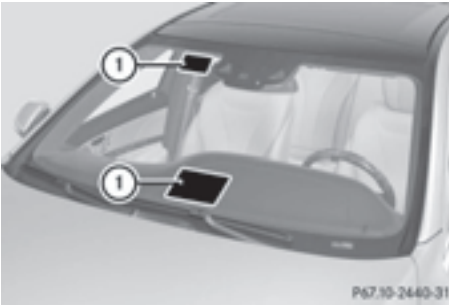

The infrared reflecting glass prevents the vehicle interior from becoming too hot. It also blocks radio waves from penetrating the windshield up into the gigahertz range.

In order to operate radio-controlled equipment, e.g. toll recording systems, areas ① on the windshield are permeable to radio waves. You can install radio-controlled devices in these areas.

These areas can best be seen from outside the vehicle by observing the light reflected off the windshield.

## Useful information

- i** This Operator's Manual describes all models and all standard and optional equipment of your vehicle available at the time of publication of the Operator's Manual. Country-specific differences are possible. Please note that your vehicle may not be equipped with all features described. This also applies to safety-related systems and functions.
- i** Read the information on qualified specialist workshops (> page 28).

## Engine compartment

### Hood

#### Important safety notes

#### WARNING

If the hood is unlatched, it may open up when the vehicle is in motion and block your view. There is a risk of an accident.

Never unlatch the hood while driving. Before every trip, ensure that the hood is locked.

#### WARNING

When opening and closing the hood, it may suddenly fall into the closed position. There is a risk of injury to persons within range of movement of the hood.

Open and close the hood only when no one is within its range of movement.

#### WARNING

Opening the hood when the engine is overheated or when there is a fire in the engine compartment could expose you to hot gases or other service products. There is a risk of injury.

Let an overheated engine cool down before opening the hood. If there is a fire in the engine compartment, keep the hood closed and contact the fire department.

#### WARNING

The engine compartment contains moving components. Certain components, such as the radiator fan, may continue to run or start again suddenly when the ignition is off. There is a risk of injury.

If you need to do any work inside the engine compartment:

- switch off the ignition
- never reach into the area where there is a risk of danger from moving components, such as the fan rotation area
- remove jewelry and watches
- keep items of clothing and hair, for example, away from moving parts

#### WARNING

The ignition system and the fuel injection system work under high voltage. If you touch components which are under voltage, you could get an electric shock. There is a risk of injury.

Never touch components of the ignition system or fuel injection system when the ignition is switched on.

## Opening the hood

#### WARNING

Certain components in the engine compartment, such as the engine, radiator and parts of the exhaust system, can become very hot. Working in the engine compartment poses a risk of injury.

Where possible, let the engine cool down and touch only the components described in the following.

#### WARNING

When the hood is open and the windshield wipers are set in motion, you can be injured by the wiper linkage. There is a risk of injury.

Always switch off the windshield wipers and the ignition before opening the hood.

**!** Make sure that the windshield wipers are not folded away from the windshield. You could otherwise damage the windshield wipers or the hood.

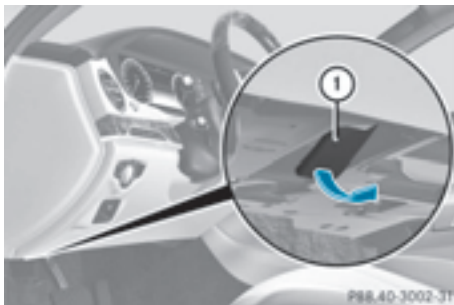

- ▶ Make sure that the windshield wipers are turned off.
- ▶ Pull release lever ① on the hood. The hood is released.



- ▶ Reach into the gap, pull hood catch handle ② up and lift the hood. Once you have lifted the hood about 15 inches (40 cm), it is automatically opened the rest of the way and held open by the gas-filled struts.

### Closing the hood

- ▶ Lower the hood and let it fall from a height of approximately 8 in (20 cm).
- ▶ Check that the hood has engaged properly. If the hood can be raised slightly, it is not properly engaged. Open it again and close it with a little more force.

## Engine oil

### General notes

Depending on your driving style, the vehicle consumes up to 0.9 US qt (0.8 l) of oil per 600 miles (1000 km). The oil consumption may be higher than this when the vehicle is new or if you frequently drive at high engine speeds.

Depending on the engine, the oil dipstick may be in a different location.

When checking the oil level:

- park the vehicle on a level surface.
- the engine should be switched off for approximately five minutes if the engine is at normal operating temperature.
- if the engine is not at normal operating temperature, e.g. if the engine was only started briefly, wait about 30 minutes before carrying out the measurement.

### Checking the oil level using the oil dipstick (except S 600 and Mercedes-AMG S 65 models)

#### WARNING

Certain components in the engine compartment, such as the engine, radiator and parts of the exhaust system, can become very hot. Working in the engine compartment poses a risk of injury.



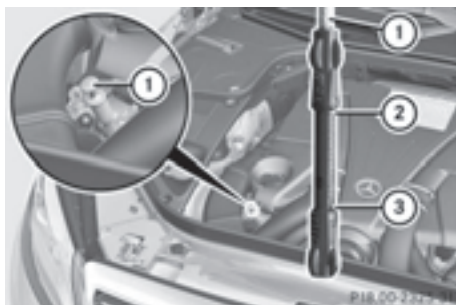



Where possible, let the engine cool down and touch only the components described in the following.



## Example

- ▶ Pull oil dipstick ① out of the dipstick guide tube.
- ▶ Wipe off oil dipstick ①.
- ▶ Slowly slide oil dipstick ① into the guide tube to the stop, and take it out again.  
If the level is between MIN mark ③ and MAX mark ②, the oil level is correct.
- ▶ If the oil level has dropped to MIN mark ③ or below, add 1.1 US qt (1.0 liter) of engine oil.

## Checking the oil level using the on-board computer (S 600 and Mercedes-AMG S 65 models)

- ▶ Make sure that the SmartKey is in position **2** in the ignition lock.
- ▶ Use  on the steering wheel to call up the list of menus.
- ▶ Press the  or  button on the steering wheel to select the **Service** menu.
- ▶ Confirm by pressing  on the steering wheel.
- ▶ Use  or  to select the **Engine Oil Level** submenu.
- ▶ Press  to confirm the selection.  
The **Measuring Engine Oil Level Accurate Only When Vehicle Is Level** message appears in the multifunction display.

The measurement takes a few seconds. You will see one of the following messages in the multifunction display:

Display messages	Possible causes/consequences and ► Solutions
Engine Oil Level OK	The oil level is correct.
Check Engine Oil Level (Add 1 Liter)	The oil level is too low. ▶ Add 1.1 US qt (1.0 liter) of engine oil.
Reduce Engine Oil Level	The engine oil level is too high. ▶ Have excess engine oil siphoned off.
For Engine Oil Level Ignition Must Be On	The ignition is switched off. ▶ Turn the SmartKey to position <b>2</b> in the ignition lock.
Need More Time to Check Engine Oil Level	The required waiting period was not observed. ▶ If the engine is at normal operating temperature: repeat the measurement after about five minutes. If the engine is not at normal operating temperature, e.g. if the engine was only started briefly: repeat the measurement after approximately 30 minutes.
Engine Oil Level Not Measurable with Engine Running	The engine is running; oil level measurement is not possible. ▶ Switch off the engine. ▶ If the engine is at normal operating temperature: wait about five minutes before carrying out the measurement. If the engine is not at normal operating temperature, e.g. if the engine was only started briefly: wait approximately 30 minutes before carrying out the measurement.

### Adding engine oil

#### **WARNING**

Certain components in the engine compartment, such as the engine, radiator and parts of the exhaust system, can become very hot. Working in the engine compartment poses a risk of injury.

Where possible, let the engine cool down and touch only the components described in the following.

**⚠ WARNING**

If engine oil comes into contact with hot components in the engine compartment, it may ignite. There is a risk of fire and injury.

Make sure that engine oil is not spilled next to the filler neck. Let the engine cool down and thoroughly clean the engine oil off the components before starting the engine.

**🌿 Environmental note**

When adding oil, take care not to spill any. If oil enters the soil or waterways, it is harmful to the environment.

**!** Only use engine oils and oil filters that have been approved for vehicles with a service system. You can obtain a list of the engine oils and oil filters tested and approved in accordance with the Mercedes-Benz Specifications for Service Products at any Mercedes-Benz Service center.

Damage to the engine or exhaust system is caused by the following:

- using engine oils and oil filters that have not been specifically approved for the service system
- replacing engine oil and oil filters after the interval for replacement specified by the service system has been exceeded
- using engine oil additives.

**!** Do not add too much oil. adding too much engine oil can result in damage to the engine or to the catalytic converter. Have excess engine oil siphoned off.

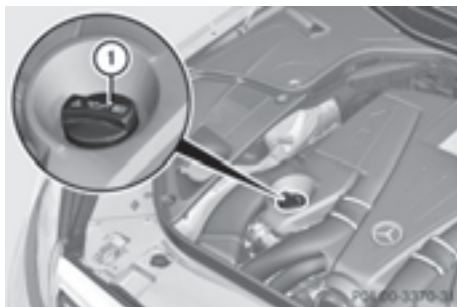

## Example

- ▶ Turn cap ① counter-clockwise and remove it.
- ▶ Add engine oil.  
If the oil level is at or below the MIN mark on the oil dipstick, add 1.1 US qt (1.0 liter) of engine oil.
- ▶ Replace cap ① on the filler neck and tighten clockwise.  
Ensure that the cap locks into place securely.
- ▶ Check the oil level again with the oil dipstick (▷ page 353).

Further information on engine oil (▷ page 429).

**Additional service products****Checking coolant level****⚠ WARNING**

Certain components in the engine compartment, such as the engine, radiator and parts of the exhaust system, can become very hot. Working in the engine compartment poses a risk of injury.

Where possible, let the engine cool down and touch only the components described in the following.

**⚠ WARNING**

The cooling system is pressurized, particularly when the motor is warm. If you open the cap, you could be scalded if hot coolant sprays out. There is a risk of injury.

Let the engine cool down before you open the cap. Wear gloves and eye protection. Slowly open the cap to relieve pressure.



- ▶ Park the vehicle on a level surface.  
Only check the coolant level when the vehicle is on a level surface and the engine has cooled down.

- ▶ Turn the SmartKey to position **2** in the ignition lock (▷ page 162).

or

- ▶ Press Start/Stop button twice (▷ page 162).
- ▶ Check the coolant temperature display in the instrument cluster.

The coolant temperature must be below 158 °F (70 °C).

- ▶ Turn the SmartKey to position **0** (▷ page 162) in the ignition lock.

or

- ▶ Remove Start/Stop button from ignition lock (▷ page 162).

- ▶ Slowly turn cap ① counter-clockwise and to relieve excess pressure.

- ▶ Turn cap ① further counter-clockwise and remove it.

If the coolant is at the level of marker bar ③ in the filler neck when cold, there is enough coolant in coolant expansion tank ②.

If the coolant level is approximately 0.6 in (1.5 cm) above marker bar ③ in the filler neck when warm, there is enough coolant in expansion tank ②.

- ▶ If necessary, add coolant that has been tested and approved by Mercedes-Benz.
- ▶ Replace cap ① and turn it clockwise as far as it will go.

Vehicles with PLUG-IN HYBRID operation: the second coolant expansion tank must not be filled.

For further information on coolant, see (▷ page 431).

## Adding washer fluid to the windshield washer system

### WARNING

Certain components in the engine compartment, such as the engine, radiator and parts of the exhaust system, can become very hot. Working in the engine compartment poses a risk of injury.

Where possible, let the engine cool down and touch only the components described in the following.

### WARNING

Windshield washer concentrate could ignite if it comes into contact with hot engine components or the exhaust system. There is a risk of fire and injury.

Make sure that no windshield washer concentrate is spilled next to the filler neck.



- ▶ **To open:** pull cap ① upwards by the tab.
- ▶ Place cap ① on the edge of the filler neck and engage in place.
- ▶ Add the premixed washer fluid.
- ▶ **To close:** press cap ① onto the filler neck until it engages.

If the washer fluid level drops below the recommended minimum of 1 liter, a message appears in the multifunction display prompting you to add washer fluid (▷ page 311).

Further information on windshield washer fluid/antifreeze (▷ page 431).

## ASSYST PLUS

### Service message

The ASSYST PLUS service interval display informs you of the next service due date.

Information on the type of service and service intervals (see the separate Maintenance Booklet).

You can obtain further information from an authorized Mercedes-Benz Center or at <http://www.mbusa.com> (USA only).

**i** The ASSYST PLUS service interval display does not show any information on the engine oil level. Observe the notes on the engine oil level (▷ page 353).

The multifunction display shows a service message for several seconds, e.g.:

- Service A in XX Days
- Service A Due
- Service A Overdue by XX Days

Depending on the operating conditions of the vehicle, the remaining time or distance until the next service due date is displayed.

The letter **A** or **B**, possibly in connection with a number or another letter, indicates the type of service. **A** stands for a minor service and **B** for a major service.

You can obtain further information from an authorized Mercedes-Benz Center.

The ASSYST PLUS service interval display does not take into account any periods of time during which the battery is disconnected.

Maintaining the time-dependent service schedule:

- ▶ Note down the service due date displayed in the multifunction display before disconnecting the battery.

or

- ▶ After reconnecting the battery, subtract the battery disconnection periods from the service date shown on the display.

### Hiding a service message

- ▶ Press the **OK** or **↩** button on the steering wheel.

### Displaying service messages

- ▶ Switch the ignition on.
- ▶ Use **⏠** on the steering wheel to call up the list of menus.
- ▶ Press **▲** or **▼** on the steering wheel to select the **Service** menu and confirm with **OK**.
- ▶ Press **▲** or **▼** on the steering wheel to select the **ASSYST PLUS** submenu and confirm with **OK**.

The service due date appears in the multifunction display.

## Information about Service

### Resetting the ASSYST PLUS service interval display

**i** If the ASSYST PLUS service interval display has been inadvertently reset, this setting can be corrected at a qualified specialist workshop.

Have service work carried out as described in the Maintenance Booklet. This may otherwise lead to increased wear and damage to the major assemblies or the vehicle.

A qualified specialist workshop, e.g. an authorized Mercedes-Benz Center, will reset the ASSYST PLUS service interval display after the service work has been carried out. You can also obtain further information on maintenance work, for example.

### Special service requirements

The specified maintenance interval takes only the normal operation of the vehicle into account. Under arduous operating conditions or increased load on the vehicle, maintenance work must be carried out more frequently, for example:

- regular city driving with frequent intermediate stops
- if the vehicle is primarily used to travel short distances
- use in mountainous terrain or on poor road surfaces
- if the engine is often left idling for long periods

Under these or similar conditions, have, for example, the air filter, engine oil and oil filter replaced or changed more frequently. Under arduous operating conditions, the tires must be checked more often. Further information can be obtained at a qualified specialist workshop, e.g. an authorized Mercedes-Benz Center.

### Driving abroad

An extensive Mercedes-Benz Service network is also available in other countries. You can obtain further information from any authorized Mercedes-Benz Center.



## Care

## General notes

 Environmental note

Dispose of empty packaging and cleaning cloths in an environmentally responsible manner.

**!** For cleaning your vehicle, do not use any of the following:

- dry, rough or hard cloths
- abrasive cleaning agents
- solvents
- cleaning agents containing solvents

Do not scrub.

Do not touch the surfaces or protective films with hard objects, e.g. a ring or ice scraper. You could otherwise scratch or damage the surfaces and protective film.

**!** Do not park the vehicle for an extended period straight after cleaning it, particularly after having cleaned the wheels with wheel cleaner. Wheel cleaners could cause increased corrosion of the brake discs and brake pads/linings. For this reason, you should drive for a few minutes after cleaning. Braking heats the brake discs and the brake pads/linings, thus drying them. The vehicle can then be parked.

Regular care of your vehicle is a condition for retaining the quality in the long term.

Use care products and cleaning agents recommended and approved by Mercedes-Benz.

## Washing the vehicle and cleaning the paintwork

## Automatic car wash

 WARNING

Braking efficiency is reduced after washing the vehicle. There is a risk of an accident.

After the vehicle has been washed, brake carefully while paying attention to the traffic conditions until full braking power is restored.

**!** If DISTRONIC PLUS or the HOLD function is activated, the vehicle brakes automatically in certain situations.

To prevent damage to the vehicle, deactivate DISTRONIC PLUS and the HOLD function in the following or other similar situations:

- when towing the vehicle
- in the car wash

**!** Never clean your vehicle in a Touchless Automatic Car Wash as these use special cleaning agents. These cleaning agents can damage the paintwork or plastic parts.

**!** Make sure that:

- the side windows and the sliding sunroof are fully closed.
- the ventilation/heating is switched off (the OFF button has been pressed).
- the windshield wiper switch is at position **0**.
- the 360° camera or rear view camera is switched off.

The vehicle may otherwise be damaged.

**!** If the SmartKey is within the rear detection range of KEYLESS-GO, the following situations, for example, could lead to the unintentional opening of the trunk:

- using a car wash
- using a power washer

Make sure that the SmartKey is at least 10 ft (3 m) away from the vehicle.

**!** Make sure that the automatic transmission is in neutral position **N** when washing your vehicle in a tow-through car wash. The vehicle may otherwise be damaged.

- Operating with the SmartKey:

Do not remove the SmartKey from the ignition lock. Do not open the driver's door when the engine is switched off or at very low speeds. Otherwise, when in transmission position **D** or **R** the automatic transmission will automatically switch to park position **P** and block the wheels.

- Operating with the Start/Stop button:

Do not open the driver's door when the engine is switched off or at very low speeds. Otherwise, when in transmission position **D** or **R** the automatic transmission will automatically switch to park position **P** and block the wheels.

Observe the following to make sure that the automatic transmission stays in position **N** neutral:

Operating with the SmartKey:

- ▶ Make sure that the ignition is switched on.
- ▶ Make sure that the vehicle is stationary.
- ▶ Depress and hold the brake pedal.
- ▶ Shift to neutral **N**.
- ▶ Release the brake pedal.
- ▶ Release the electric parking brake, if necessary.
- ▶ Switch off the ignition and leave the SmartKey in the ignition lock.

Operating with the Start/Stop button:

- ▶ Make sure that the ignition is switched on.
- ▶ Make sure that the vehicle is stationary.
- ▶ Depress and hold the brake pedal.
- ▶ Engage park position **P**.
- ▶ Release the brake pedal.
- ▶ Remove Start/Stop button from ignition lock (> page 162).
- ▶ Insert the SmartKey into the ignition lock.
- ▶ Switch on the ignition.
- ▶ Depress and hold the brake pedal.
- ▶ Shift to neutral **N**.
- ▶ Release the brake pedal.
- ▶ Release the electric parking brake, if necessary.
- ▶ Switch off the ignition and leave the SmartKey in the ignition lock.

You can wash the vehicle in an automatic car wash from the very start.

If the vehicle is very dirty, pre-wash it before cleaning it in an automatic car wash.

After using an automatic car wash, wipe off wax from the windshield and the wiper blades. This will prevent smears and reduce wiping noises caused by residue on the windshield.

### Washing by hand

In some countries, washing by hand is only allowed at specially equipped washing bays. Observe the legal requirements in each country.

- ▶ Do not use hot water and do not wash the vehicle in direct sunlight.
- ▶ Use a soft sponge to clean.

- ▶ Use a mild cleaning agent, such as a car shampoo approved by Mercedes-Benz.
- ▶ Thoroughly hose down the vehicle with a gentle jet of water.
- ▶ Do not point the water jet directly towards the air inlet.
- ▶ Use plenty of water and rinse out the sponge frequently.
- ▶ Rinse the vehicle with clean water and dry thoroughly with a chamois.
- ▶ Do not let the cleaning agent dry on the paintwork.

Carefully remove all deposits of road salt as soon as possible when driving in winter.

### Power washers

#### WARNING

The water jet from a circular jet nozzle (dirt blasters) can cause invisible exterior damage to the tires or chassis components. Components damaged in this way may fail unexpectedly. There is a risk of an accident.

Do not use power washers with circular jet nozzles to clean the vehicle. Have damaged tires or chassis components replaced immediately.

- ❗ Always maintain a distance of at least 11.8 in (30 cm) between the vehicle and the power washer nozzle. Information about the correct distance is available from the equipment manufacturer.

Move the power washer nozzle around when cleaning your vehicle.

Do not aim directly at any of the following:

- tires
- door gaps, roof gaps, joints, etc.
- electrical components
- battery
- connectors
- lights
- seals
- trim
- ventilation slots

Damaged seals or electrical components can lead to leaks or failures.

**!** If the SmartKey is within the rear detection range of KEYLESS-GO, the following situations, for example, could lead to the unintentional opening of the trunk:

- using a car wash
- using a power washer

Make sure that the SmartKey is at least 10 ft (3 m) away from the vehicle.

## Cleaning the paintwork

**!** Do not affix:

- stickers
- films
- magnetic plates or similar items

to painted surfaces. You could otherwise damage the paintwork.

Scratches, corrosive deposits, areas affected by corrosion and damage caused by inadequate care cannot always be completely repaired. In such cases, visit a qualified specialist workshop.

- ▶ Remove dirt immediately, where possible, while avoiding rubbing too hard.
- ▶ Soak insect remains with insect remover and rinse off the treated areas afterwards.
- ▶ Soak bird droppings with water and rinse off the treated areas afterwards.
- ▶ Remove coolant, brake fluid, tree resin, oils, fuels and greases by rubbing gently with a cloth soaked in petroleum ether or lighter fluid.
- ▶ Use tar remover to remove tar stains.
- ▶ Use silicone remover to remove wax.

If water no longer forms "beads" on the paint surface, use the paint care products recommended and approved by Mercedes-Benz. This is the case approximately every three to five months, depending on the climate conditions and the care product used.

If dirt has penetrated the paint surface or if the paint has become dull, the paint cleaner recommended and approved by Mercedes-Benz should be used.

Do not use these care products in the sun or on the hood while the hood is hot.

- ▶ Use a suitable touch-up stick, e.g. MB Touch-Up Stick, to repair slight damage to the paintwork quickly and provisionally.

## Matte finish care

**!** Never polish the vehicle or the light alloy wheels. Polishing causes the finish to shine.

**!** The following may cause the paint to become shiny and thus reduce the matte effect:

- strong rubbing of the paintwork with unsuitable materials
- frequent use of automatic car washes
- washing the vehicle in direct sunlight

**!** Never use paint cleaner, buffing or polishing products, or gloss preserver, e.g. wax. These products are only suitable for high-gloss surfaces. Their use on vehicles with matte finish leads to considerable surface damage (shiny, mottled areas).

Always have paintwork repairs carried out at a qualified specialist workshop.

**!** Do not use wash programs with a hot wax treatment under any circumstances.

Observe these notes if your vehicle has a clear matte finish. This will help you to avoid damage to the paintwork due to incorrect treatment.

These notes also apply to light alloy wheels with a clear matte finish.

The vehicle should preferably be washed by hand using a soft sponge, car shampoo and plenty of water.

Use only insect remover and car shampoo from the range of approved Mercedes-Benz care products.

## Cleaning the vehicle parts

### Cleaning the wheels

#### WARNING

The water jet from a circular jet nozzle (dirt blasters) can cause invisible exterior damage to the tires or chassis components. Components damaged in this way may fail unexpectedly. There is a risk of an accident.

Do not use power washers with circular jet nozzles to clean the vehicle. Have damaged tires or chassis components replaced immediately.

**!** Do not use acidic wheel cleaning products to remove brake dust. This could damage wheel bolts and brake components.

**!** Do not park the vehicle for an extended period straight after cleaning it, particularly after having cleaned the wheels with wheel cleaner. Wheel cleaners could cause increased corrosion of the brake discs and brake pads/linings. For this reason, you should drive for a few minutes after cleaning. Braking heats the brake discs and the brake pads/linings, thus drying them. The vehicle can then be parked.

### Cleaning the windows

#### WARNING

You could become trapped by the windshield wipers if they start moving while cleaning the windshield or wiper blades. There is a risk of injury.

Always switch off the windshield wipers and the ignition before cleaning the windshield or wiper blades.

**!** Do not use dry cloths, abrasive products, solvents or cleaning agents containing solvents to clean the inside of the windows. Do not touch the insides of the windows with hard objects, e.g. an ice scraper or ring. There is otherwise a risk of damaging the windows.

**!** Clean the water drainage channels of the windshield and the rear window at regular intervals. Deposits such as leaves, petals and pollen may under certain circumstances prevent water from draining away. This can lead to corrosion damage and damage to electronic components.

- ▶ Clean the inside and outside of the windows with a damp cloth and a cleaning product that is recommended and approved by Mercedes-Benz.

### Cleaning wiper blades

#### WARNING

You could become trapped by the windshield wipers if they start moving while cleaning the windshield or wiper blades. There is a risk of injury.

Always switch off the windshield wipers and the ignition before cleaning the windshield or wiper blades.

**!** Do not pull the wiper blade. Otherwise, the wiper blade could be damaged.

**!** Do not clean wiper blades too often and do not rub them too hard. Otherwise, the graphite coating could be damaged. This could cause wiper noise.

**!** Hold the wiper arm securely when folding back. The windshield could be damaged if the wiper arm smacks against it suddenly.

- ▶ Fold the windshield wiper arms away from the windshield (▷ page 136).
- ▶ Carefully clean the wiper blades with a damp cloth.
- ▶ Fold the windshield wiper arms back again before switching on the ignition.

### Cleaning the exterior lighting

**!** Only use cleaning agents or cleaning cloths which are suitable for plastic light lenses. Unsuitable cleaning agents or cleaning cloths could scratch or damage the plastic light lenses.

- ▶ Clean the plastic lenses of the exterior lights with a wet sponge and a mild cleaning agent, e.g. Mercedes-Benz car shampoo or cleaning cloths.

### Mirror turn signals

**!** Only use cleaning agents or cleaning cloths that are suitable for plastic lenses. Unsuitable cleaning agents or cleaning cloths could scratch or damage the plastic lenses of the mirror turn signals.

- ▶ Clean the plastic lenses of the mirror turn signals in the exterior mirror housing using a wet sponge and mild cleaning agent, e.g. Mercedes-Benz car shampoo or cleaning cloths.

### Cleaning the sensors

**!** If you clean the sensors with a power washer, make sure that you keep a distance of at least 11.8 in (30 cm) between the vehicle and the power washer nozzle. Information

about the correct distance is available from the equipment manufacturer.

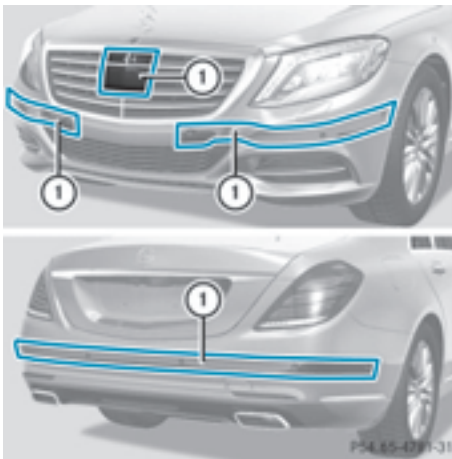



- ▶ Clean sensors ① of the driving systems with water, car shampoo and a soft cloth.

### Cleaning the rear view camera

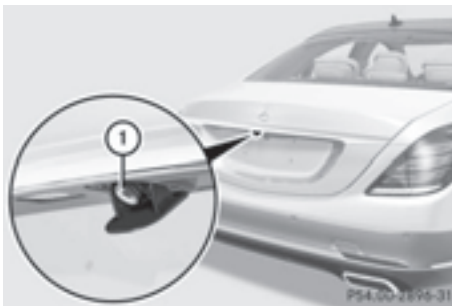
- ❗ Do not clean the camera lens and the area around the rear view camera with a power washer.





- ▶ Make sure that the vehicle is stationary and that the SmartKey is in position **2** in the ignition lock.
- ▶ **To open the cover of the rear view camera:** with the multimedia system activated, call up the vehicle menu: press the  button.
- ▶ To switch to the menu bar: slide  the controller.
- ▶ To select **System Settings**: turn and press the controller.
- ▶ To select **Rear View Camera**: turn and press the controller.

- ▶ To select **Open Camera Cover**: turn and press the controller.  
The rear view camera cover opens.
- ▶ **To clean the rear view camera:** use clear water and a soft cloth to clean camera lens ①.

### Cleaning the 360° camera

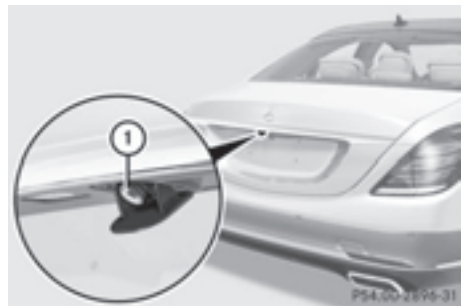
- ❗ Do not clean the camera lens and the area around the 360° camera with a power washer. 360



- ▶ Make sure that the vehicle is stationary and that the SmartKey is in position **2** in the ignition lock.
- ▶ **To open the cover of the 360° camera:** with the multimedia system activated, call up the vehicle menu: press the  button.
- ▶ To switch to the menu bar: slide  the controller.
- ▶ To select **System Settings**: turn and press the controller.
- ▶ To select the **360° Camera**: turn and press the controller.
- ▶ To select **Open Camera Cover**: turn and press the controller.  
The cover of the 360° camera opens.
- ▶ **To clean the 360° camera:** clean camera lens ① with clean water and a soft cloth.

If you drive at speeds above 20 mph (30 km/h) or with the SmartKey in position **0** or **1** in the ignition lock, the cover of the 360° camera closes automatically.

### Cleaning the exhaust pipes

#### **WARNING**

The exhaust tail pipe and tail pipe trim can become very hot. If you come into contact

with these parts of the vehicle, you could burn yourself. There is a risk of injury.

Always be particularly careful around the exhaust tail pipe and the tail pipe trim. Allow these components to cool down before touching them.

- ❗ Do not clean the exhaust pipe with acid-based cleaning agents, such as bathroom cleaner or wheel cleaner.

Impurities combined with the effects of road grit and corrosive environmental factors may cause flash rust to form on the surface. You can restore the original shine of the exhaust pipe by cleaning it regularly, especially in winter and after washing.

- ▶ Clean the exhaust pipe with a care product tested and approved by Mercedes-Benz.

### Interior care

#### Cleaning the display

- ❗ For cleaning, do not use any of the following:

- alcohol-based thinner or gasoline
- abrasive cleaning agents
- commercially-available household cleaning agents

These may damage the display surface. Do not put pressure on the display surface when cleaning. This could lead to irreparable damage to the display.

- ▶ Before cleaning the display, make sure that it is switched off and has cooled down.
- ▶ Clean the display surface using a commercially available microfiber cloth and TFT/LCD display cleaner.
- ▶ Dry the display surface using a dry microfiber cloth.

#### Cleaning Night and Day View Assist

#### Cleaning the camera behind the windshield

- ❗ Never clean the camera lens. When cleaning the field of vision of the driving systems, make sure that you do not spray glass cleaner on the camera lens. If the camera lens is dirty, visit a qualified specialist workshop.



- ▶ Fold down the camera cover by recess ①.

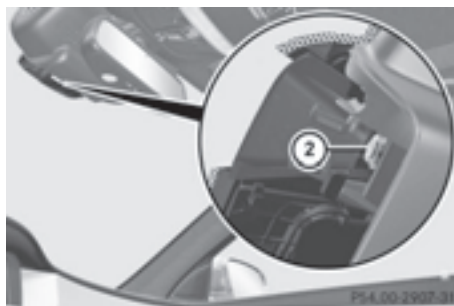

- ▶ Use a soft cloth to clean the windshield in front of camera ②.

#### Cleaning the camera in the radiator trim



Camera lens ① is cleaned at regular intervals by operating the windshield washer system.

- ▶ Use clear water and a soft cloth to clean camera lens ① when it is very dirty.

#### Cleaning the plastic trim

#### ⚠ WARNING

Care products and cleaning agents containing solvents cause surfaces in the cockpit to

become porous. As a result, plastic parts may come loose in the event of air bag deployment. There is a risk of injury.

Do not use any care products and cleaning agents to clean the cockpit.

❗ Do not affix the following to plastic surfaces:

- stickers
- films
- scented oil bottles or similar items

You can otherwise damage the plastic.

❗ Do not allow cosmetics, insect repellent or sunscreen to come into contact with the plastic trim. This maintains the high-quality look of the surfaces.

- ▶ Wipe the plastic trim with a damp, lint-free cloth, e.g. a microfiber cloth.
- ▶ **Heavy soiling:** use care and cleaning products recommended and approved by Mercedes-Benz.  
The surface may change color temporarily. Wait until the surface is dry again.

### Cleaning the steering wheel and gear or selector lever

- ▶ Thoroughly wipe with a damp cloth or use leather care agents that have been recommended and approved by Mercedes-Benz.

### Cleaning genuine wood and trim elements

❗ Do not use solvent-based cleaning agents such as tar remover, wheel cleaners, polishes or waxes. There is otherwise a risk of damaging the surface.

❗ Do not use chrome polish on trim pieces. The trim pieces have a chrome look but are mostly made of anodized aluminum and can lose their shine if chrome polish is used. Use a damp, lint-free cloth instead when cleaning the trim pieces.

If the chrome-plated trim pieces are very dirty, you can use a chrome polish. If you are unsure as to whether the trim pieces are chrome-plated or not, consult an authorized Mercedes-Benz Center.

- ▶ Wipe the wooden trim and trim pieces with a damp, lint-free cloth, e.g. a microfiber cloth.
- ▶ **Heavy soiling:** use care and cleaning products recommended and approved by Mercedes-Benz.

### Cleaning the seat covers

#### General notes

❗ Do not use a microfiber cloth to clean covers made out of real leather, artificial leather or DINAMICA. If used often, these can damage the cover.

Note that regular care is essential to ensure that the appearance and comfort of the covers is retained over time.

#### Genuine leather seat covers

- ❗ To retain the natural appearance of the leather, observe the following cleaning instructions:
- Clean genuine leather covers carefully with a damp cloth and then wipe the covers down with a dry cloth.
  - Make sure that the leather does not become soaked. It may otherwise become rough and cracked.
  - Only use leather care agents that have been tested and approved by Mercedes-Benz. You can obtain these from a qualified specialist workshop.

Leather is a natural product.

It exhibits natural surface characteristics, for example:

- differences in the texture
- marks caused by growth and injury
- slight nuances of color

These are characteristics of leather and not material defects.

#### Seat covers of other materials

- ❗ Observe the following when cleaning:
- clean artificial leather covers with a cloth moistened with a solution containing 1% detergent (e.g. dish washing liquid).
  - clean cloth covers with a microfiber cloth moistened with a solution containing 1% detergent (e.g. dish washing liquid). Rub carefully and always wipe entire seat sections to avoid leaving visible lines. Leave

the seat to dry afterwards. Cleaning results depend on the type of dirt and how long it has been there.

- clean DINAMICA covers with a damp cloth. Make sure that you wipe entire seat sections to avoid leaving visible lines.

### Cleaning the seat belts

#### WARNING

Seat belts can become severely weakened if bleached or dyed. This could cause the seat belts to tear or fail, for instance, in the event of an accident. This poses an increased risk of injury or fatal injury.

Never bleach or dye the seat belts.

- ❗ Do not clean the seat belts using chemical cleaning agents. Do not dry the seat belts by heating at temperatures above 176 °F (80 °C) or in direct sunlight.

- ▶ Use clean, lukewarm water and soap solution.

### Cleaning the headliner and carpets

- ▶ **Headliner:** if it is very dirty, use a soft brush or dry shampoo.
- ▶ **Carpets:** use the carpet and textile cleaning agents recommended and approved by Mercedes-Benz.



**Useful information**

- i** This Operator's Manual describes all models and all standard and optional equipment of your vehicle available at the time of publication of the Operator's Manual. Country-specific differences are possible. Please note that your vehicle may not be equipped with all features described. This also applies to safety-related systems and functions.
- i** Read the information on qualified specialist workshops (▷ page 28).

**Where will I find...?**

**Vehicle tool kit**

**General notes**

The towing eye is located in the stowage well under the trunk floor.  
 Some tools for changing a wheel are specific to the vehicle. For more information on which tire changing tools are required and approved to perform a wheel change on your vehicle, consult a qualified specialist workshop.  
 Tools required for changing a wheel may include, for example:

- Jack
- Wheel chock
- Lug wrench
- Ratchet wrench
- Alignment bolt

**Vehicles with a TIREFIT kit**

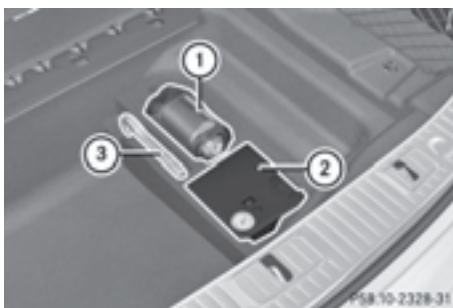

- ① Tire sealant filler bottle
- ② Tire inflation compressor
- ③ Towing eye

- ▶ Open the trunk lid.
- ▶ Lift the trunk floor upwards (▷ page 329).
- ▶ Use the TIREFIT kit (▷ page 369).

**Mercedes-AMG vehicles**



- ① Tire sealant filler bottle
- ② Jack
- ③ Ratchet
- ④ Alignment bolt
- ⑤ Jacking support
- ⑥ Socket
- ⑦ Lug wrench
- ⑧ Towing eye
- ⑨ Folding wheel chock
- ⑩ Tire inflation compressor

The tire-change tool kit is in a tray in the stowage well under the trunk floor.

- ▶ Open the trunk lid.
- ▶ Lift the trunk floor upwards (▷ page 329).
- i** Example: equipment and country-specific variations possible.

**Flat tire**

**Preparing the vehicle**

Your vehicle may be equipped with:

- tires with run-flat characteristics (MOExtended tires) (▷ page 368)  
 Vehicle preparation is not necessary on vehicles with MOExtended tires
- a TIREFIT kit (▷ page 367)

Vehicles equipped with MOExtended tires are not equipped with a TIREFIT kit at the factory. It is therefore recommended that you additionally equip your vehicle with a TIREFIT kit if you mount tires that do not feature run-flat properties, e.g.

winter tires. A TIREFIT kit may be obtained from a qualified specialist workshop.

Information on changing and mounting wheels (▷ page 405).

- ▶ Stop the vehicle on solid, non-slippery and level ground, as far away as possible from traffic.
- ▶ Switch on the hazard warning lamps.
- ▶ Secure the vehicle against rolling away (▷ page 189).
- ▶ If possible, bring the front wheels into the straight-ahead position.
- ▶ Switch off the engine.
- ▶ Open the driver's door.  
The on-board electronics now have status **0**. This is the same as the SmartKey having been removed.
- ▶ Remove the Start/Stop button from the ignition lock (▷ page 162).

or, if the SmartKey is inserted in the ignition lock:

- ▶ Remove the SmartKey from the ignition lock.
- ▶ Make sure that the engine cannot be started via your smartphone (▷ page 164).
- ▶ Make sure that the passengers are not endangered as they do so. Make sure that no one is near the danger area while a wheel is being changed. Anyone who is not directly assisting in the wheel change should, for example, stand behind the barrier.
- ▶ Get out of the vehicle. Pay attention to traffic conditions when doing so.
- ▶ Close the driver's door.

### MOExtended tires (tires with run-flat properties)

#### General notes

With MOExtended tires (tires with run flat characteristics), you can continue to drive your vehicle even if there is a total loss of pressure in one or more tires. The affected tire must not show any clearly visible damage.

You can recognize MOExtended tires by the MOExtended marking which appears on the sidewall of the tire. You will find this marking next to the tire size designation, the load-bearing capacity and the speed index (▷ page 400).

MOExtended tires may only be used in conjunction with an active tire pressure loss warning system or with an active tire pressure monitor.

#### If a pressure loss warning message appears in the multifunction display:

- observe the instructions in the display messages (▷ page 306).
- check the tire for damage.
- if driving on, observe the following notes.

The driving distance possible in run-flat mode is approximately 50 miles (80 km) when the vehicle is partially laden. When the vehicle is fully laden it is approximately 19 miles (30 km).

In addition to the vehicle load, the driving distance possible depends upon:

- vehicle speed
- road condition
- outside temperature

The driving distance possible in run-flat mode may be reduced by extreme driving conditions or maneuvers, or it can be increased through a moderate style of driving.

The driving distance possible in run-flat mode is counted from the moment the tire pressure loss warning appears in the multifunction display.

You must not exceed a maximum speed of 50 mph (80 km/h).

When replacing one or all tires, please observe the following specifications for your vehicle's tires:

- size
- the type and
- the "MOExtended" mark

If a tire has gone flat and cannot be replaced with a MOExtended tire, a standard tire may be used as a temporary measure. Make sure that you use the proper size and type (summer or winter tire).

Vehicles equipped with MOExtended tires are not equipped with a TIREFIT kit at the factory. It is therefore recommended that you additionally equip your vehicle with a TIREFIT kit if you mount tires that do not feature run-flat properties, e.g. winter tires. A TIREFIT kit may be obtained from a qualified specialist workshop.

## Important safety notes

### WARNING

When driving in emergency mode, the driving characteristics deteriorate, e.g. when cornering, accelerating quickly and when braking. There is a risk of an accident.

Do not exceed the stated maximum speed. Avoid abrupt steering and driving maneuvers, and driving over obstacles (curbs, potholes, off-road). This applies in particular to a laden vehicle.

Stop driving in emergency mode if:

- you hear banging noises.
- the vehicle starts to shake.
- you see smoke and smell rubber.
- ESP® is intervening constantly.
- there are tears in the sidewalls of the tire.

After driving in emergency mode, have the wheel rims checked at a qualified specialist workshop with regard to their further use. The defective tire must be replaced in every case.

## TIREFIT kit

### Important safety notes

TIREFIT is a tire sealant.

You can use TIREFIT to seal punctures of up to 0.16 in (4 mm), particularly those in the tire tread. You can use TIREFIT at outside temperatures down to -4 °F (-20 °C).

### WARNING

In the following situations, the tire sealant is unable to provide sufficient breakdown assistance, as it is unable to seal the tire properly:

- there are cuts or punctures in the tire larger than those mentioned above.
- the wheel rim is damaged.
- you have driven at very low tire pressures or on a flat tire.

There is a risk of an accident.

Do not drive the vehicle. Contact a qualified specialist workshop.

### WARNING

The tire sealant is harmful and causes irritation. It must not come into contact with your skin, eyes or clothing or be swallowed. Do not inhale TIREFIT fumes. Keep tire sealant away from children. There is a risk of injury.

If you come into contact with the tire sealant, observe the following:

- Rinse off the tire sealant from your skin immediately with water.
- If the tire sealant comes into contact with your eyes, immediately rinse them thoroughly with clean water.
- If tire sealant is swallowed, immediately rinse your mouth out thoroughly and drink plenty of water. Do not induce vomiting, and seek medical attention immediately.
- Immediately change out of clothing which has come into contact with tire sealant.
- If an allergic reaction occurs, seek medical attention immediately.

 Do not operate the tire inflation compressor for longer than eight minutes at a time without a break. It may otherwise overheat.

The tire inflation compressor can be operated again once it has cooled down.

Comply with the manufacturer's safety instructions on the sticker on the tire inflation compressor.

### Using the TIREFIT kit

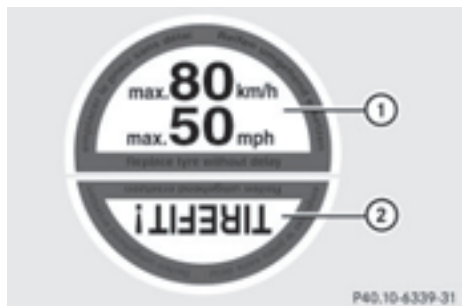

- ▶ Do not remove any foreign objects which have penetrated the tire, e.g. screws or nails.
- ▶ Remove the tire sealant bottle, the accompanying TIREFIT sticker and the tire inflation

compressor from the stowage well underneath the trunk floor (▷ page 367).

- ▶ Affix part ① of the TIREFIT sticker to the instrument cluster within the driver's field of vision.
- ▶ Affix part ② of the TIREFIT sticker near the valve on the wheel with the defective tire.

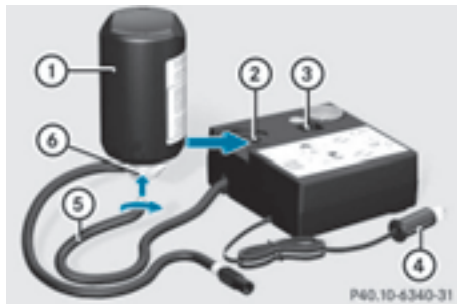

- ▶ Pull connector ④ with the cable and hose ⑤ out of the tire inflation compressor housing.
- ▶ Screw hose ⑤ onto flange ⑥ of tire sealant bottle ①.
- ▶ Place tire sealant bottle ① head downwards into recess ② of the tire inflation compressor.

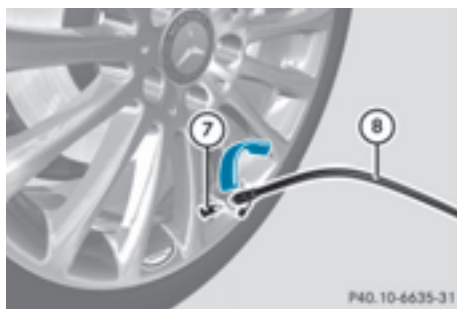

- ▶ Remove the cap from valve ⑦ on the faulty tire.
- ▶ Screw filler hose ⑧ onto valve ⑦.
- ▶ Insert connector ④ into a 12 V socket (▷ page 336) in your vehicle.
- ▶ Turn the SmartKey to position 1 in the ignition lock (▷ page 162).
- ▶ Press on and off switch ③ on the tire inflation compressor to I. The tire inflation compressor is switched on. The tire is inflated.

First, tire sealant is pumped into the tire. The pressure can briefly rise to approximately 500 kPa (5 bar/73 psi).

**Do not switch off the tire inflation compressor during this phase.**

- ▶ Let the tire inflation compressor run for a maximum of five minutes. The tire should then have attained a pressure of at least 180 kPa (1.8 bar/26 psi).

If a pressure of 180 kPa (1.8 bar/26 psi) has been attained after five minutes, see "Tire pressure reached" (▷ page 371).

If a tire pressure of 180 kPa (1.8 bar/26 psi) has not been attained after five minutes, see "Tire pressure not reached" (▷ page 370).

If tire sealant has escaped, clean it off affected areas as quickly as possible. Use plain water if possible.

If your clothes are soiled with tire sealant, have them cleaned with perchloroethylene at a dry cleaner as soon as possible.

### Tire pressure not reached

If a pressure of 180 kPa (1.8 bar/26 psi) has not been attained after five minutes:

- ▶ Switch off the tire inflation compressor.
- ▶ Unscrew the filler hose from the valve of the faulty tire.
  - Note that tire sealant may escape when you unscrew the filler hose.
- ▶ Very slowly drive forwards or reverse approximately 30 ft (10 m).
- ▶ Pump up the tire again.

After a maximum of five minutes the tire pressure must be at least 180 kPa (1.8 bar/26 psi).

### WARNING

If the required tire pressure is not reached after the specified time, the tire is too badly damaged. The tire sealant cannot repair the tire in this instance. Damaged tires and a tire pressure that is too low can significantly impair the vehicle's braking and driving characteristics. There is a risk of accident.

Do not continue driving. Contact a qualified specialist workshop.

## Tire pressure reached

### WARNING

A tire temporarily sealed with tire sealant impairs the driving characteristics and is not suitable for higher speeds. There is a risk of accident.

You should therefore adapt your driving style accordingly and drive carefully. Do not exceed the specified maximum speed with a tire that has been repaired using tire sealant.

The maximum permissible speed for a tire sealed with tire sealant is 50 mph (80 km/h). The upper part of the TIREFIT sticker must be affixed to the instrument cluster in the driver's field of vision.

**!** Residue from the tire sealant may come out of the filler hose after use. This could cause stains.

Therefore, place the filler hose in the plastic bag which contained the TIREFIT kit.

### Environmental note

Have the used tire sealant bottle disposed of professionally, e.g. at a qualified specialist workshop.

If a tire pressure of 180 kPa (1.8 bar/26 psi) has been attained after five minutes:

- ▶ Switch off the tire inflation compressor.
- ▶ Unscrew the filler hose from the valve of the faulty tire.
- ▶ Stow the tire sealant bottle and the tire inflation compressor.
- ▶ **Pull away immediately.**
- ▶ Stop after driving for approximately ten minutes and check the tire pressure with the tire inflation compressor.  
The tire pressure must now be at least 130 kPa (1.3 bar/19 psi).

### WARNING

If the required tire pressure is not reached after driving for a short period, the tire is too badly damaged. The tire sealant cannot repair the tire in this instance. Damaged tires and a tire pressure that is too low can significantly

impair the vehicle's braking and driving characteristics. There is a risk of accident.

Do not continue driving. Contact a qualified specialist workshop.

**i** In cases such as the one mentioned above, contact an authorized Mercedes-Benz Center. Or call 1-800-FOR-MERCEDES (in the USA) or 1-800-387-0100 (in Canada).

- ▶ Correct the tire pressure if it is still at least 130 kPa (1.3 bar/19 psi). See the Tire and Loading Information placard on the driver's side B-pillar or the tire pressure table in the fuel filler flap for values.
- ▶ **To increase the tire pressure:** switch on the tire inflation compressor.

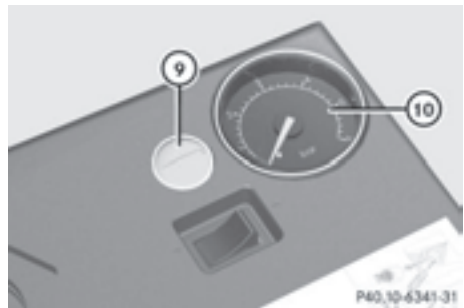

- ▶ **To reduce the tire pressure:** depress pressure release button **9** next to pressure gauge **10**.
- ▶ When the tire pressure is correct, unscrew the filler hose from the valve of the sealed tire.
- ▶ Screw the valve cap onto the tire valve of the sealed tire.
- ▶ Pull the tire sealant bottle out of the tire inflation compressor.  
The filler hose remains attached to the tire sealant bottle.
- ▶ Drive to the nearest qualified specialist workshop and have the tire changed there.
- ▶ Have the tire sealant bottle replaced as soon as possible at a qualified specialist workshop.
- ▶ Have the tire sealant bottle replaced every four years at a qualified specialist workshop.

## Battery (vehicle)

### 12 V battery – important safety notes

PLUG-IN HYBRID vehicles are equipped with a 12 V battery and a high-voltage battery. The following notes refer to the 12 V battery. Notes on the high-voltage battery can be obtained in the "High-voltage battery – important safety notes" section (▷ page 374).

Special tools and expert knowledge are required when working on the battery, e.g. removal and installation. You should therefore have all work involving the battery carried out at a qualified specialist workshop.

#### WARNING

Work carried out incorrectly on the battery can lead, for example, to a short circuit and thus damage the vehicle electronics. This can lead to function restrictions applying to safety-relevant systems, e.g. the lighting system, the ABS (anti-lock braking system) or the ESP® (Electronic Stability Program). The operating safety of your vehicle may be restricted. You could lose control of the vehicle, for example:

- when braking
- in the event of abrupt steering maneuvers and/or when the vehicle's speed is not adapted to the road conditions

There is a risk of an accident.

In the event of a short circuit or a similar incident, contact a qualified specialist workshop immediately. Do not drive any further. You should have all work involving the battery carried out at a qualified specialist workshop.

For further information about ABS and ESP®, see (▷ page 68) and (▷ page 73).

**All vehicles except Mercedes-AMG vehicles:**

#### WARNING

Electrostatic build-up can lead to the creation of sparks, which could ignite the highly explosive gases of a battery. There is a risk of an explosion.

Before handling the battery, touch the vehicle body to remove any existing electrostatic build-up.

The highly flammable gas mixture forms when charging the battery as well as when jump-starting.

Always make sure that neither you nor the battery is electrostatically charged. A build-up of electrostatic charge can be caused, for example:

- by wearing clothing made from synthetic fibres
- due to friction between clothing and seats
- if you push or pull the battery across the carpet or other synthetic materials
- if you wipe the battery with a cloth

#### WARNING

During the charging process, a battery produces hydrogen gas. If a short circuit occurs or sparks are created, the hydrogen gas can ignite. There is a risk of an explosion.

- Make sure that the positive terminal of a connected battery does not come into contact with vehicle parts.
- Never place metal objects or tools on a battery.
- It is important that you observe the described order of the battery terminals when connecting and disconnecting a battery.
- When jump-starting, make sure that the battery poles with identical polarity are connected.
- It is particularly important to observe the described order when connecting and disconnecting the jumper cables.
- Never connect or disconnect the battery terminals while the engine is running.

#### WARNING

Battery acid is caustic. There is a risk of injury. Avoid contact with skin, eyes or clothing. Do not inhale any battery gases. Do not lean over the battery. Keep children away from batteries. Wash away battery acid immediately with

plenty of clean water and seek medical attention.

### All vehicles:



#### Environmental note



Batteries contain dangerous substances. It is against the law to dispose of them with the household rubbish. They must be collected separately and recycled to protect the environment.



Dispose of batteries in an environmentally friendly manner. Take discharged batteries to a qualified specialist workshop or a special collection point for used batteries.

- !** Have the battery checked regularly at a qualified specialist workshop. Observe the service intervals in the Maintenance Booklet or contact a qualified specialist workshop for more information.

- !** Always have work on batteries carried out at a qualified specialist workshop. Should it, in exceptional circumstances, be absolutely necessary to disconnect the 12-volt battery yourself, observe the following:

- secure the vehicle to prevent it from rolling away.
- switch off the ignition.
- always disconnect the negative terminal clamp first, followed by the positive terminal clamp.

After the battery has been disconnected, the transmission is locked in position **P**.

After the work has been done, install the battery and replace the cover of the positive terminal clamp firmly.

Comply with safety precautions and take protective measures when handling batteries.



Risk of explosion.



Fire, open flames and smoking are prohibited when handling the battery. Avoid creating sparks.



Electrolyte or battery acid is corrosive. Avoid contact with skin, eyes or clothing.

Wear suitable protective clothing, especially gloves, apron and face-guard.

Immediately rinse electrolyte or acid splashes off with clean water. Contact a physician if necessary.

Wear eye protection.



Keep children away.



Observe this Operator's Manual.

For safety reasons, Mercedes-Benz recommends that you only use batteries which have been tested and approved for your vehicle by Mercedes-Benz. These batteries provide increased impact protection to prevent vehicle occupants from suffering acid burns should the battery be damaged in the event of an accident.

In order for the battery to achieve the maximum possible service life, it must always be sufficiently charged.

Like other batteries, the vehicle battery may discharge over time if you do not use the vehicle. In this case, have the battery disconnected at a qualified specialist workshop. You can also charge the battery with a charger recommended by Mercedes-Benz. Contact a qualified specialist workshop for further information.

Have the battery condition of charge checked more frequently if you use the vehicle mainly for short trips or if you leave it standing idle for a lengthy period. Consult a qualified specialist workshop if you wish to leave your vehicle parked for a long period of time.

Remove the SmartKey if you park the vehicle and do not require any electrical consumers. The vehicle will then use very little energy, thus conserving battery power.

**PLUG-IN HYBRID vehicles:** if the battery charge is sufficient, the high-voltage battery can also supply the 12 V battery. This only happens if the condition of charge of the 12 V battery requires this, e.g. after using electrical consumers for an extended period with the engine switched off. As the on-board voltage is continuously monitored this can also be performed when the engine is switched off. The condition of charge of the 12 V battery and the on-board voltage are thereby kept stable for a longer period.

### High-voltage battery – important safety notes

Only PLUG-IN HYBRID vehicles are equipped with a high-voltage battery.

#### DANGER

The vehicle's high-voltage electrical system is under high voltage. If you modify components in the vehicle's high-voltage electrical system or touch damaged components, you may be electrocuted. The components in the vehicle's high-voltage electrical system may be damaged in an accident, although the damage is not visible. There is a risk of fatal injury.

Following an accident, do not touch any high-voltage components and never modify the vehicle's high-voltage electrical system. Have the vehicle towed away after an accident and the vehicle's high-voltage electrical system checked by a qualified specialist workshop.

#### WARNING

In the event of a vehicle fire, the internal pressure of the high-voltage battery can exceed a critical value. In this case flammable gas escapes through a ventilation valve on the underbody. The gas can ignite. There is a risk of injury.

Leave the danger zone immediately. Secure the danger area at a suitable distance, whilst observing legal requirements.

#### WARNING

If the housing of the high-voltage battery has been damaged, electrolyte and gases may leak out. These are poisonous and caustic. There is a risk of injury.

Avoid contact with skin, eyes or clothing. Immediately rinse electrolyte splashes off with water and seek medical attention straight away.

-  Exhaustive discharge caused by the vehicle standing idle for lengthy periods can damage the high-voltage battery. If the vehicle is idle for lengthy periods leave the high-voltage battery connected to a charging station.

Consult an authorized Mercedes-Benz Center if you wish to leave your vehicle parked for a long period of time.

### Charging the 12 V battery

#### Mercedes-AMG vehicles:

-  Only use battery chargers with a maximum charging voltage of 14.4 V.

#### All other vehicles:

#### WARNING

During charging and jump-starting, explosive gases can escape from the battery. There is a risk of an explosion.

Particularly avoid fire, open flames, creating sparks and smoking. Ensure there is sufficient ventilation while charging and jump-starting. Do not lean over a battery.

#### WARNING

Battery acid is caustic. There is a risk of injury. Avoid contact with skin, eyes or clothing. Do not inhale any battery gases. Do not lean over the battery. Keep children away from batteries. Wash away battery acid immediately with plenty of clean water and seek medical attention.

#### WARNING

A discharged battery can freeze at temperatures below freezing point. When jump-start-



ing the vehicle or charging the battery, gases can escape from the battery. There is a risk of an explosion.

Allow the frozen battery to thaw out before charging it or jump-starting.

- ❗ Only use battery chargers with a maximum charging voltage of 14.8 V.

#### All vehicles:

- ❗ Only charge the battery using the jump-starting connection point.

The jump-starting connection point is in the engine compartment (▷ page 376).

- ▶ Open the hood.
- ▶ Connect the battery charger to the positive terminal and ground point in the same order as when connecting the donor battery in the jump-starting procedure (▷ page 376).

Keep away from fire and open flames. Do not lean over a battery. Never charge the battery if it is still installed in the vehicle, unless you use a battery charger which has been tested and approved by Mercedes-Benz. A battery charger unit specially adapted for Mercedes-Benz vehicles and tested and approved by Mercedes-Benz is available as an accessory. It permits the charging of the battery in its installed position. Contact an authorized Mercedes-Benz Center for further information and availability. Read the battery charger's operating instructions before charging the battery.

#### All vehicles except Mercedes-AMG vehicles:

if the indicator/warning lamps in the instrument cluster do not light up at low temperatures, it is very likely that the discharged battery has frozen. In this case you may neither jump-start the vehicle nor charge the battery. The service life of a thawed-out battery may be shorter. The starting characteristics can be impaired, particularly at low temperatures. Have the thawed-out battery checked at a qualified specialist workshop.

**Mercedes-AMG vehicles:** at low temperatures, do not charge a battery which has been removed using a battery charger. Allow the battery to warm up gently first, if necessary. Otherwise, the service life can be shortened and the starting characteristics impaired, especially at low temperatures.

**PLUG-IN HYBRID vehicles:** if the battery charge is sufficient, the high-voltage battery can also supply the 12 V battery. This only happens

if the condition of charge of the 12 V battery requires this, e.g. after using electrical consumers for an extended period with the engine switched off. As the on-board voltage is continuously monitored this can also be performed when the engine is switched off. The condition of charge of the 12 V battery and the on-board voltage are thereby kept stable for a longer period.

## Jump-starting

For the jump-starting procedure, use only the jump-starting connection point in the engine compartment, consisting of a positive terminal and a ground point.

**All vehicles except Mercedes-AMG vehicles:**

### WARNING

Battery acid is caustic. There is a risk of injury.

Avoid contact with skin, eyes or clothing. Do not inhale any battery gases. Do not lean over the battery. Keep children away from batteries. Wash away battery acid immediately with plenty of clean water and seek medical attention.

### WARNING

During charging and jump-starting, explosive gases can escape from the battery. There is a risk of an explosion.

Particularly avoid fire, open flames, creating sparks and smoking. Ensure there is sufficient ventilation while charging and jump-starting. Do not lean over a battery.

### WARNING

During the charging process, a battery produces hydrogen gas. If a short circuit occurs or sparks are created, the hydrogen gas can ignite. There is a risk of an explosion.

- Make sure that the positive terminal of a connected battery does not come into contact with vehicle parts.
- Never place metal objects or tools on a battery.
- It is important that you observe the described order of the battery terminals when connecting and disconnecting a battery.
- When jump-starting, make sure that the battery poles with identical polarity are connected.
- It is particularly important to observe the described order when connecting and disconnecting the jumper cables.
- Never connect or disconnect the battery terminals while the engine is running.

### WARNING

A discharged battery can freeze at temperatures below freezing point. When jump-starting the vehicle or charging the battery, gases can escape from the battery. There is a risk of an explosion.

Allow the frozen battery to thaw out before charging it or jump-starting.

If, at low temperatures, the indicator lamps/warning lamps in the instrument cluster do not light up, it is highly likely that the discharged battery has frozen. In this case, you may neither charge the battery nor jump-start the vehicle. The service life of a thawed-out battery may be shorter. The starting characteristics can be impaired, particularly at low temperatures. Have the thawed-out battery checked at a qualified specialist workshop.

**All vehicles:**

- ! Avoid repeated and lengthy starting attempts. Otherwise, the catalytic converter could be damaged by the non-combusted fuel.

Do not start the vehicle using a rapid charging device. If your vehicle's battery is discharged, the engine can be jump-started from another vehicle or from a second battery using jumper cables. Observe the following points:

- The battery is not accessible in all vehicles. If the other vehicle's battery is not accessible, jump-start the vehicle using a second battery or a jump-starting device.
- You may only jump-start the vehicle when the engine and exhaust system are cold.
- **All vehicles except Mercedes-AMG vehicles:** do not start the engine if the battery is frozen. Let the battery thaw first.
- Only jump-start from batteries with a 12 V voltage rating.
- Only use jumper cables which have a sufficient cross-section and insulated terminal clamps.
- If the battery is fully discharged, leave the battery that is being used to jump-start connected for a few minutes before attempting to start. This charges the battery slightly.
- Make sure that the two vehicles do not touch.

Make sure that:

- the jumper cables are not damaged.
- when the jumper cables are connected to the battery, uninsulated sections of the terminal clamp do not come into contact with other metal sections.
- the jumper cables cannot come into contact with parts which can move when the engine is running, such as the V-belt pulley or the fan.
- ▶ Secure the vehicle by applying the electric parking brake.
- ▶ Shift the transmission to position **P**.
- ▶ Make sure that the ignition is switched off. All indicator lamps in the instrument cluster must be off. When using the SmartKey, turn the SmartKey to position **0** in the ignition lock and remove it (▷ page 162).
- ▶ Switch off all electrical consumers, e.g. rear window defroster, lighting, etc.
- ▶ Open the hood.



Example: ground point cover

- ▶ Turn fasteners ① one  $\frac{1}{4}$  turn and remove.
- ▶ Remove the cover while pressing down on cap ② of the washer fluid reservoir.

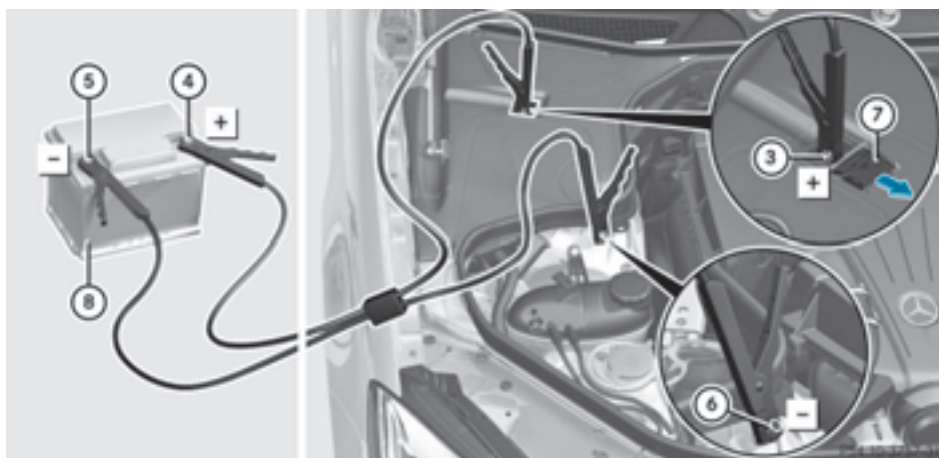

Position number ⑧ identifies the charged battery of the other vehicle or an equivalent jump-starting device.

- ▶ Slide cover ⑦ of positive terminal ③ in the direction of the arrow.
- ▶ Connect positive terminal ③ on your vehicle to positive terminal ④ of donor battery ⑧ using the jumper cable. Always begin with positive terminal ③ on your own vehicle first.
- ▶ Start the engine of the donor vehicle and run it at idling speed.
- ▶ Connect negative terminal ⑤ of donor battery ⑧ to ground point ⑥ of your vehicle using the jumper cable, connecting the jumper cable to donor battery ⑧ first.
- ▶ Start the engine.
- ▶ Before disconnecting the jumper cables, let the engine run for several minutes.
- ▶ First, remove the jumper cables from ground point ⑥ and negative terminal ⑤, then from positive clamp ③ and positive terminal ④. Begin each time at the contacts on your own vehicle first.
- ▶ After removing the jumper cables, close cover ⑦ of positive terminal ③.
- ▶ Replace the earth point cover. Make sure all mountings for the fasteners are positioned precisely beneath the corresponding recesses in the cover.
- ▶ Press fasteners ① into the mountings. Turn the fasteners by  $\frac{1}{4}$  of a turn to engage.
- ▶ Have the battery checked at a qualified specialist workshop.

**PLUG-IN HYBRID vehicles:** if your vehicle has been jump-started, it may not be possible to use the electric drive for approximately 30 minutes.

Jump-starting is not considered to be a normal operating condition.

- ① Jumper cables and further information regarding jump-starting can be obtained at any qualified specialist workshop.

## Towing and tow-starting

### Important safety notes

#### WARNING

Functions relevant to safety are restricted or no longer available if:

- the engine is not running.
- the brake system or the power steering is malfunctioning.
- there is a malfunction in the voltage supply or the vehicle's electrical system.

If your vehicle is being towed, much more force may be necessary to steer or brake. There is a risk of an accident.

In such cases, use a tow bar. Before towing, make sure that the steering moves freely.

#### WARNING

When towing or tow-starting another vehicle and its weight is greater than the permissible gross weight of your vehicle, the:

- the towing eye could detach itself
- the vehicle/trailer combination could roll-over.

There is a risk of an accident.

When towing or tow-starting another vehicle, its weight should not be greater than the permissible gross weight of your vehicle.

Details on the permissible gross vehicle weight of your vehicle can be found on the vehicle identification plate (▷ page 426).

- !** When COLLISION PREVENTION ASSIST PLUS, DISTRONIC PLUS or the HOLD function is activated, the vehicle brakes automatically in certain situations.

To avoid damage to the vehicle, deactivate these systems in the following or similar situations:

- when towing the vehicle
- in the car wash

- !** Make sure that the electric parking brake is released. If the electric parking brake is faulty, visit a qualified specialist workshop.

- !** Secure the tow rope or tow bar to the towing eye only. Otherwise, the vehicle could become damaged.

- !** Do not use the towing eyes for recovery purposes as this could damage the vehicle. If in doubt, recover the vehicle with a crane.

- !** When towing, pull away slowly and smoothly. If the tractive power is too high, the vehicles could be damaged.

- !** Shift the automatic transmission to **N** and do not open the driver's or front passenger's door during towing. The automatic transmission may otherwise shift to position **P**, which could damage the transmission.

- !** Do not tow with sling-type equipment. This could damage the vehicle.

- !** The vehicle can be towed a maximum of 30 miles (50km). The towing speed of 30 mph (50 km/h) must not be exceeded. If the vehicle has to be towed more than 30 miles (50km), the entire vehicle must be raised and transported.

It is better to have the vehicle transported than to have it towed away.

If the vehicle has suffered transmission damage, have it transported on a transporter or trailer.

The automatic transmission must be in position **N** when the vehicle is being towed.

If the automatic transmission cannot be shifted to position **N**, have the vehicle transported on a transporter or trailer.

The battery must be connected and charged. Otherwise, you:

- cannot turn the SmartKey to position **2** in the ignition lock
- cannot release the electric parking brake
- cannot shift the automatic transmission to position **N**

Disarm the automatic locking feature before the vehicle is towed (▷ page 87). You could otherwise be locked out when pushing or towing the vehicle.

#### **PLUG-IN HYBRID vehicles:**

PLUG-IN HYBRID vehicles may not be towed away but must instead be transported, if:

- the multifunction display is not working or
- the  **Towing Not Permitted See Operator's Manual** message appears in the multifunction display.

If the vehicle is in a dangerous area, it can be towed out of that area with both axles on the ground. In this case, the towing distance must not be greater than 165 ft (50 m) and must not exceed a towing speed of 6 mph (10 km/h). For longer distances, have the vehicle loaded and transported.

### Installing/removing the towing eye

#### Installing the towing eye

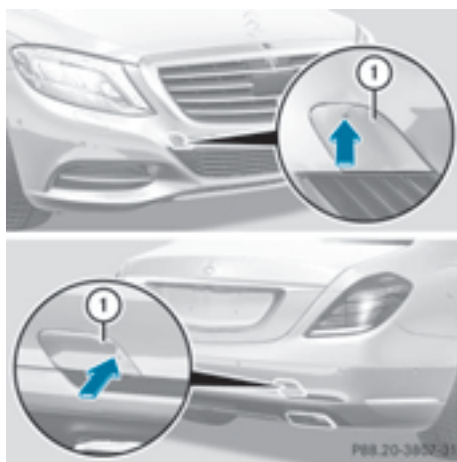

The brackets for the screw-in towing eye are located in the bumpers. They are at the rear and at the front, under covers ①.

- ▶ Remove the towing eye from the vehicle tool kit/stowage tray (▷ page 367).
- ▶ Press the mark on cover ① inwards in the direction of the arrow.
- ▶ Remove cover ① from the opening.
- ▶ Screw in the towing eye clockwise as far as it will go and tighten it.

#### Removing the towing eye

- ▶ Unscrew and remove the towing eye.
- ▶ Attach cover ① to the bumper and press until it engages.
- ▶ Place the towing eye in the vehicle tool kit/stowage tray.

#### Towing a vehicle with both axles on the ground

It is important that you observe the safety instructions when towing away your vehicle (▷ page 379).

The automatic transmission automatically shifts to position **P** when you open the driver's or front-passenger door or when you remove the SmartKey from the ignition lock.

In order to ensure that the automatic transmission stays in position **N** when towing the vehicle, you must observe the following points:

- ▶ You must use the SmartKey instead of the Start/Stop button (▷ page 162).
- ▶ Make sure that the vehicle is stationary and that the key is in position **0** in the ignition lock.
- ▶ Turn the SmartKey to position **2** in the ignition lock.
- ▶ Depress and hold the brake pedal.
- ▶ Shift the automatic transmission to position **N**.
- ▶ Release the brake pedal.
- ▶ Release the electric parking brake.
- ▶ Leave the SmartKey in position **2** in the ignition lock.
- ▶ Switch on the hazard warning lamps (▷ page 132).

In order to signal a change of direction when towing the vehicle with the hazard warning lamps switched on, use the combination switch as usual. In this case, only the indicator lamps for the direction of travel flash. After resetting the combination switch, the hazard warning lamp starts flashing again.

## Transporting the vehicle

### PLUG-IN HYBRID vehicles

Transportation of the vehicle should only be carried out by professional recovery companies.

### 4MATIC vehicles/vehicles with automatic transmission

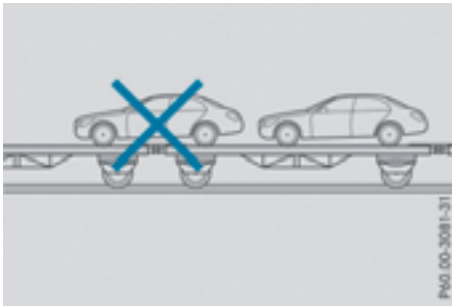

**!** When the vehicle is loaded for transport, the front and rear axles must be stationary and on the same transportation vehicle. Positioning over the connection point of the transport vehicle is not permitted. The drive train may otherwise be damaged.

### All vehicles

**!** You may only secure the vehicle by the wheels, not by parts of the vehicle such as axle or steering components. Otherwise, the vehicle could be damaged.

The towing eye can be used to pull the vehicle onto a trailer or transporter for transporting purposes.

- ▶ Turn the SmartKey to position **2** in the ignition lock.
- ▶ Shift the automatic transmission to position **N**.

#### As soon as the vehicle has been loaded:

- ▶ Prevent the vehicle from rolling away by applying the electric parking brake.
- ▶ Shift the automatic transmission to position **P**.
- ▶ Turn the SmartKey to position **0** in the ignition lock and remove it.
- ▶ Secure the vehicle.

## Notes on 4MATIC vehicles

**!** Vehicles with 4MATIC must not be towed with either the front or the rear axle raised, as doing so will damage the transmission.

Vehicles with 4MATIC may either be towed away with both axles on the ground or be loaded up and transported.

If the vehicle's transmission, front, or rear axle is damaged, have the vehicle transported on a truck or trailer.

**In the event of damage to the electrical system:** if the battery is defective, the automatic transmission will be locked in position **P**. To shift the automatic transmission to position **N**, you must provide power to the vehicle's electrical system in the same way as when jump-starting (▷ page 376).

Have the vehicle transported on a transporter or trailer.

## Tow-starting (emergency engine starting)

**!** Vehicles with automatic transmission must not be tow-started. You could otherwise damage the automatic transmission.

**i** Information on "Jump-starting" (▷ page 376).

## Fuses

### Important safety notes

#### **⚠ WARNING**

If you manipulate or bridge a faulty fuse or if you replace it with a fuse with a higher amperage, the electric cables could be overloaded. This could result in a fire. There is a risk of an accident and injury.

Always replace faulty fuses with the specified new fuses having the correct amperage.

Blown fuses must be replaced with fuses of the same rating, which you can recognize by the color and value. The fuse ratings are listed in the fuse allocation chart.

The fuse allocation chart is on the fuse box in the trunk (▷ page 381).

If a newly inserted fuse also blows, have the cause traced and rectified at a qualified specialist workshop, e.g. an authorized Mercedes-Benz Center.

**!** Only use fuses that have been approved for Mercedes-Benz vehicles and which have the correct fuse rating for the system concerned. Otherwise, components or systems could be damaged.

The fuses in your vehicle serve to close down faulty circuits. If a fuse blows, all the components on the circuit and their functions stop operating.

### Before changing a fuse

- ▶ Switch off the engine.
- ▶ Switch off all electrical consumers.
- ▶ Make sure that the ignition is switched off (▷ page 162).

or

- ▶ When using the SmartKey, turn the SmartKey to position **0** in the ignition lock and remove it (▷ page 162).
- ▶ Secure the vehicle against rolling away (▷ page 189).

All indicator lamps in the instrument cluster must be off.

The fuses are located in various fuse boxes:

- Fuse box on the driver's side of the dashboard
- Fuse box in the front-passenger footwell
- Fuse box in the engine compartment on the left-hand side of the vehicle, when viewed in the direction of travel
- Fuse box in the trunk

### Dashboard fuse box

**!** Do not use a pointed object such as a screwdriver to open the cover in the dashboard. You could damage the dashboard or the cover.

**!** Make sure that no moisture can enter the fuse box when the cover is open.

**!** When closing the cover, make sure that it is lying correctly on the fuse box. Moisture seeping in or dirt could otherwise impair the operation of the fuses.

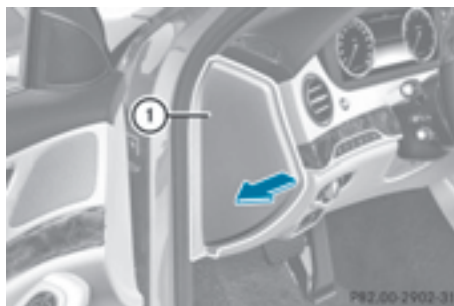

- ▶ Open the driver's door.
- ▶ **To open:** pull cover ① outwards in the direction of the arrow and remove it.
- ▶ **To close:** clip in cover ① on the front of the dashboard.
- ▶ Fold cover ① inwards until it engages.

### Fuse box in the front-passenger footwell

**!** Make sure that no moisture can enter the fuse box when the cover is open.

**!** When closing the cover, make sure that it is lying correctly on the fuse box. Moisture seeping in or dirt could otherwise impair the operation of the fuses.



- ▶ Open the front-passenger door.
- ▶ Fold cover ① down and remove it.



## Fuse box in the engine compartment

### ⚠ WARNING

When the hood is open and the windshield wipers are set in motion, you can be injured by the wiper linkage. There is a risk of injury.

Always switch off the windshield wipers and the ignition before opening the hood.

❗ Make sure that no moisture can enter the fuse box when the cover is open.

❗ When closing the cover, make sure that it is lying correctly on the fuse box. Moisture seeping in or dirt could otherwise impair the operation of the fuses.

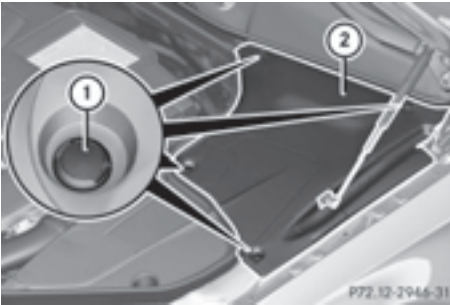

- ▶ Open the hood (▷ page 352).
- ▶ **To open:** release retaining clamps (1) and remove cover (2).

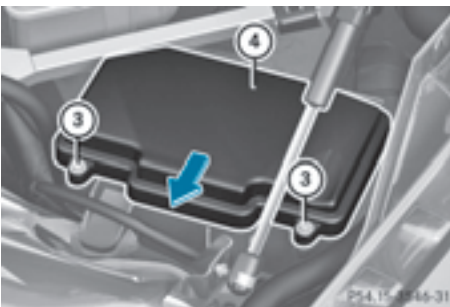

- ▶ Use a dry cloth to remove any moisture from the fuse box.
- ▶ Undo screws (3) on the fuse box.
- ▶ Remove fuse box cover (4) forwards.
- ▶ **To close:** check whether the seal is lying correctly in cover (4).

- ▶ Insert cover (4) at the rear of the fuse box into the retainer.
- ▶ Fold down cover (4) of the fuse box and tighten screws (3).
- ▶ Insert cover (2) and secure with retaining clamps (1).
- ▶ Close the hood.

## Fuse box in the trunk

❗ Make sure that no moisture can enter the fuse box when the cover is open.

❗ When closing the cover, make sure that it is lying correctly on the fuse box. Moisture seeping in or dirt could otherwise impair the operation of the fuses.

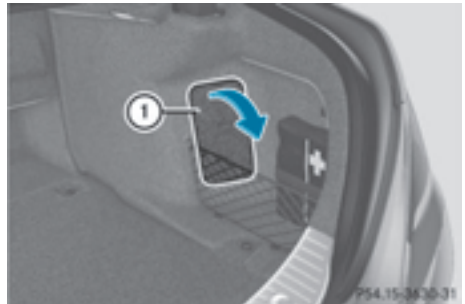

Fuse box cover (example: Mercedes-Maybach)

- ▶ Open the trunk lid.
- ▶ Prise open cover (1) with a flat object at the top right and top left-hand side.
- ▶ Open cover (1) downwards in the direction of the arrow.

**i** The fuse allocation chart is located in a recess at the side of the fuse box. You can find the corresponding fuse rating and fuse type on the fuse allocation chart.

## Useful information

- i** This Operator's Manual describes all models and all standard and optional equipment of your vehicle available at the time of publication of the Operator's Manual. Country-specific differences are possible. Please note that your vehicle may not be equipped with all features described. This also applies to safety-related systems and functions.
- i** Read the information on qualified specialist workshops (> page 28).

## Important safety notes

### WARNING

If wheels and tires of the wrong size are used, the wheel brakes or suspension components may be damaged. There is a risk of an accident.

Always replace wheels and tires with those that fulfill the specifications of the original part.

When replacing wheels, make sure to use the correct:

- designation
- model

When replacing tires, make sure to use the correct:

- designation
- manufacturer
- model

### WARNING

A flat tire severely impairs the driving, steering and braking characteristics of the vehicle. There is a risk of accident.

Tires without run-flat characteristics:

- do not drive with a flat tire.
- immediately replace the flat tire with your emergency spare wheel or spare wheel, or consult a qualified specialist workshop.

Tires with run-flat characteristics:

- pay attention to the information and warning notices on MOExtended tires (tires with run-flat characteristics).

Accessories that are not approved for your vehicle by Mercedes-Benz or are not being used correctly can impair the operating safety.

Before purchasing and using non-approved accessories, visit a qualified specialist workshop and inquire about:

- suitability
- legal stipulations
- factory recommendations

Information on the sizes and types of wheels and tires for your vehicle can be found under "Wheel/tire combinations" (> page 410).

Information on tire pressure can be found:

- on the vehicle's Tire and Loading Information placard on the B-pillar (> page 394)
- in the tire pressure table in the fuel filler flap (> page 189)
- under "Tire pressure" (> page 387)

## Operation

### Information on driving

Check the tire pressure when the vehicle is heavily laden and adjust prior to a trip.

While driving, pay attention to vibrations, noises and unusual handling characteristics, e.g. pulling to one side. This may indicate that the wheels or tires are damaged. If you suspect that a tire is defective, reduce your speed immediately. Stop the vehicle as soon as possible to check the wheels and tires for damage. Hidden tire damage could also be causing the unusual handling characteristics. If you find no signs of damage, have the tires and wheels checked at a qualified specialist workshop.

When parking your vehicle, make sure that the tires do not get deformed by the curb or other obstacles. If they cannot be avoided, drive over obstacles such as curbs slowly and at an obtuse angle. Otherwise, you may damage the wheels or tires.

## Regular checking of wheels and tires

### WARNING

Damaged tires can cause tire inflation pressure loss. As a result, you could lose control of your vehicle. There is a risk of accident.

Check the tires regularly for signs of damage and replace any damaged tires immediately.

Check wheels and tires for damage at least once a month. Check wheels and tires after driving off-road or on rough roads. Damaged wheels can cause a loss of tire pressure. Pay particular attention to damage such as:

- cuts in the tires
- punctures
- tears in the tires
- bulges on tires
- deformation or severe corrosion on wheels

Regularly check the tire tread depth and the condition of the tread across the whole width of the tire (▷ page 385). If necessary, turn the front wheels to full lock in order to inspect the inner side of the tire surface.

All wheels must have a valve cap to protect the valve against dirt and moisture. Do not mount anything onto the valve other than the standard valve cap or other valve caps approved by Mercedes-Benz for your vehicle. Do not use any other valve caps or systems, e.g. tire pressure monitoring systems.

Regularly check the pressure of all the tires particularly prior to long trips. Adjust the tire pressure as necessary (▷ page 387).

The service life of tires depends, among other things, on the following factors:

- driving style
- tire pressure
- distance covered

## Notes on tire tread

### WARNING

Insufficient tire tread will reduce tire traction. The tire is no longer able to dissipate water. This means that on wet road surfaces, the risk of hydroplaning increases, in particular where

speed is not adapted to suit the driving conditions. There is a risk of accident.

If the tire pressure is too high or too low, tires may exhibit different levels of wear at different locations on the tire tread. Thus, you should regularly check the tread depth and the condition of the tread across the entire width of all tires.

Minimum tire tread depth for:

- Summer tires: 1/8 in (3 mm)
- M+S tires: 1/6 in (4 mm)

For safety reasons, replace the tires before the legally prescribed limit for the minimum tire tread depth is reached.

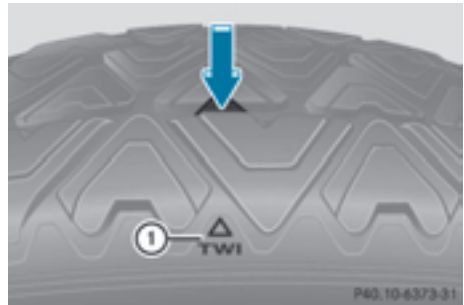

Marking ① shows where the bar indicator (arrow) for tread wear is integrated into the tire tread.

Treadwear indicators (TWI) are required by law. Six indicators are positioned on the tire tread. They are visible once a tread depth of approximately 1/16 in (1.6 mm) has been reached. If this is the case, the tire is so worn that it must be replaced.

## Selecting, mounting and replacing tires

- Only mount tires and wheels of the same type and make.  
Exception: it is permissible to install a different type or make in the event of a flat tire. Observe the "MOExtended tires (tires with run-flat characteristics)" section (▷ page 368).
- Only mount tires of the correct size onto the wheels.

- Break in new tires at moderate speeds for the first 60 miles (100 km). They only reach their full performance after this distance.
- Do not drive with tires which have too little tread depth, as this significantly reduces the traction on wet roads (hydroplaning).
- Replace the tires after six years at the latest, regardless of wear.

### MOExtended tires (tires with run-flat properties)

With MOExtended tires (tires with run flat characteristics), you can continue to drive your vehicle even if there is a total loss of pressure in one or more tires.

MOExtended tires may only be used in conjunction with an active tire pressure loss warning system or with an active tire pressure monitor and on wheels specifically tested by Mercedes-Benz.

Notes on driving with MOExtended tires with a flat tire (▷ page 368).

Vehicles equipped with MOExtended tires are not equipped with a TIREFIT kit at the factory. It is therefore recommended that you additionally equip your vehicle with a TIREFIT kit if you mount tires that do not feature run-flat properties, e.g. winter tires. A TIREFIT kit can be obtained from a qualified specialist workshop.

## Winter operation

### General notes

Have your vehicle winterproofed at a qualified specialist workshop at the onset of winter. Observe the notes in the "Changing a wheel" section (▷ page 405).

### Driving with summer tires

At temperatures below 45 °F (+7 °C), summer tires lose elasticity and therefore traction and braking power. Change the tires on your vehicle to M+S tires. Using summer tires at very cold temperatures could cause cracks to form, thereby damaging the tires permanently. Mercedes-Benz cannot accept responsibility for this type of damage.

### WARNING

Damaged tires can cause tire inflation pressure loss. As a result, you could lose control of your vehicle. There is a risk of accident.

Check the tires regularly for signs of damage and replace any damaged tires immediately.

### M+S tires

### WARNING

M+S tires with a tire tread depth of less than 1/8 in (4 mm) are not suitable for use in winter and do not provide sufficient traction. There is a risk of an accident.

M+S tires with a tread depth of less than 1/8 in (4 mm) must be replaced immediately.

At temperatures below 45 °F (+7 °C), use winter tires or all-season tires. Both types of tire are identified by the M+S marking.

Only winter tires bearing the  snowflake symbol in addition to the M+S marking provide the best possible grip in wintry road conditions. Only these tires will allow driving safety systems such as ABS and ESP® to function optimally in winter. These tires have been developed specifically for driving in snow.

Use M+S tires of the same make and tread on all wheels to maintain safe handling characteristics.

Always observe the maximum permissible speed specified for the M+S tires you have mounted.

When you have mounted M+S tires:

- ▶ Check the tire pressures (▷ page 390).
- ▶ Restart the tire pressure monitor (▷ page 392).

### Snow chains

### WARNING

If snow chains are installed to the front wheels, they may drag against the vehicle body or chassis components. This could cause damage to the vehicle or the tires. There is a risk of an accident.

To avoid hazardous situations:

- never install snow chains to the front wheels
- always install snow chains in pairs to the rear wheels.

For safety reasons, Mercedes-Benz recommends that you only use snow chains that have been specially approved for your vehicle by Mercedes-Benz, or are of a corresponding standard of quality.

If you intend to mount snow chains, please bear the following points in mind:

- Snow chains may not be mounted on all wheel/tire combinations. Permissible wheel-tire combinations (▷ page 410).
- Only use snow chains when driving on roads completely covered by snow. Remove the snow chains as soon as possible when you come to a road that is not snow-covered.
- Local regulations may restrict the use of snow chains. Observe the appropriate regulations if you wish to mount snow chains.
- Do not exceed the maximum permissible speed of 31 mph (50 km/h).
- On vehicles with AIRMATIC (▷ page 212) or Magic Body Control (MBC) (▷ page 210), you must drive at raised vehicle level if snow chains have been mounted.
- When snow chains are installed, never use Active Parking Assist (▷ page 216).

You may wish to deactivate ESP® when pulling away with snow chains installed (▷ page 74). You can thereby allow the wheels to spin in a controlled manner, achieving an increased driving force (cutting action).

## Tire pressure

### Tire pressure specifications

#### Important safety notes

##### WARNING

Underinflated or overinflated tires pose the following risks:

- the tires may burst, especially as the load and vehicle speed increase.
- the tires may wear excessively and/or unevenly, which may greatly impair tire traction.
- the driving characteristics, as well as steering and braking, may be greatly impaired.

There is a risk of an accident.

Follow recommended tire inflation pressures and check the pressure of all the tires including the spare wheel:

- monthly, at least
- if the load changes
- before beginning a long journey
- under different operating conditions, e.g. off-road driving

If necessary, correct the tire pressure.

The data on the Tire and Loading Information placard and tire pressure table shown here are examples. Tire pressure specifications are vehicle-specific and may deviate from the data shown here. The tire pressure specifications that are valid for your vehicle can be found on the Tire and Loading Information placard and tire pressure table on the vehicle.

#### General notes

The recommended tire pressures for the tires mounted at the factory can be found on the labels described here.

Further information on tire pressures can be obtained at a qualified specialist workshop.

### Tire and Loading Information placard

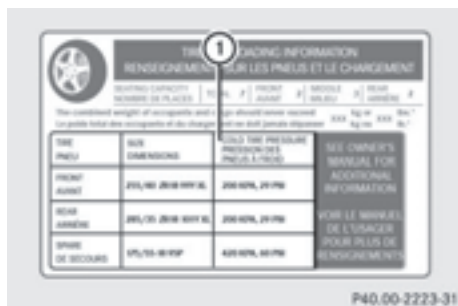

#### ① Recommended tire pressures

The Tire and Loading Information placard is on the B-pillar on the driver's side (▷ page 394). The Tire and Loading Information placard contains the recommended tire pressures for cold tires. The recommended tire pressures are valid for the maximum permissible load and up to the maximum permissible vehicle speed.

### Tire pressure table

The tire pressure table is on the inside of the fuel filler flap. It shows the tire pressure for all tires permitted at the factory for this vehicle; see illustration (example).

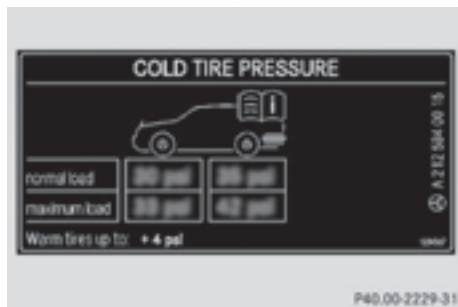

The tire pressure table contains the recommended pressures for cold tires for various operating conditions, i.e. differing load and speed conditions.

If a tire size precedes a tire pressure, the following tire pressure information is only valid for that tire size; see illustration (example).

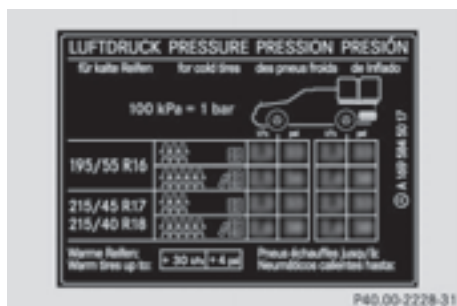

The load conditions "partially laden" and "fully laden" are defined in the table for different numbers of occupants and amounts of luggage. The actual number of seats may differ.

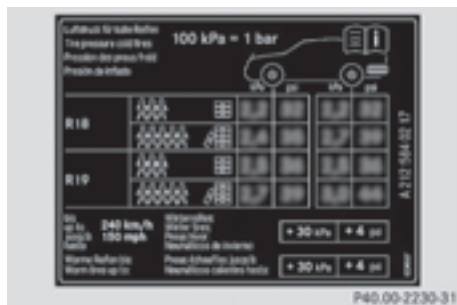

Some tire pressure tables show only the rim diameters instead of the full tire size, e.g. **R18**. Rim diameter is part of the tire size and can be found on the tire sidewall (▷ page 400).

If the tire pressures have been set to the lower values for lighter loads and/or lower road speeds, the pressures should be reset to the higher values:

- if you want to drive with an increased load and/or
- if you want to drive at higher road speeds

The tire pressures for increased loads and/or higher road speeds, shown in the tire pressure table, may have a negative effect on driving comfort.

If the tire pressure is not set correctly, this can lead to an excessive build up of heat and a sudden loss of pressure.

For more information, contact a qualified specialist workshop.

## Important notes on tire pressure

### WARNING

If the tire pressure drops repeatedly, the wheel, valve or tire may be damaged. Tire pressure that is too low may result in a tire blow-out. There is a risk of an accident.

- Check the tire for foreign objects.
- Check whether the wheel is losing air or the valve is leaking.

If you are unable to rectify the damage, contact a qualified specialist workshop.

### WARNING

If you fit unsuitable accessories onto tire valves, the tire valves may be overloaded and malfunction, which can cause tire pressure loss. Due to their design, retrofitted tire pressure monitors keep the tire valve open. This can also result in tire pressure loss. There is a risk of an accident.

Only screw the standard valve cap or other valve caps approved by Mercedes-Benz for your vehicle onto the tire valve.

Use a suitable pressure gauge to check the tire pressure. The outer appearance of a tire does not permit any reliable conclusion about the tire pressure. On vehicles equipped with the electronic tire pressure monitor, the tire pressure can be checked in the on-board computer.

The tire temperature and pressure increase when the vehicle is in motion. This is dependent on the driving speed and the load.

Therefore, you should only correct tire pressures when the tires are cold.

The tires are cold:

- if the vehicle has been parked with the tires out of direct sunlight for at least three hours and
- if the vehicle has not been driven further than 1 mile (1.6 km)

The tire temperature changes depending on the outside temperature, the vehicle speed and the tire load. If the tire temperature changes by 18 °F (10 °C), the tire pressure changes by approximately 10 kPa (0.1 bar / 1.5 psi). Take this into account when checking the pressure of warm tires. Only correct the tire pressure if it is

too low for the current operating conditions. If you check the tire pressure when the tires are warm, the resulting value will be higher than if the tires were cold. This is normal. Do not reduce the tire pressure to the value specified for cold tires. The tire pressure would otherwise be too low.

Observe the recommended tire pressures for cold tires:

- on the Tire and Loading Information placard on the B-pillar on the driver's side
- in the tire pressure table on the fuel filler flap (> page 189)

## Underinflated or overinflated tires

### Underinflated tires

#### WARNING

Tires with pressure that is too low can overheat and burst as a consequence. In addition, they also suffer from excessive and/or irregular wear, which can severely impair the braking properties and the driving characteristics. There is a risk of an accident.

Avoid tire pressures that are too low in all the tires, including the spare wheel.

Underinflated tires may:

- overheat, leading to tire defects
- adversely affect handling
- wear excessively and/or unevenly
- have an adverse effect on fuel consumption

### Overinflated tires

#### WARNING

Tires with excessively high pressure can burst because they are damaged more easily by road debris, potholes etc. In addition, they also suffer from irregular wear, which can severely impair the braking properties and the driving characteristics. There is a risk of an accident.

Avoid tire pressures that are too high in all the tires, including the spare wheel.

Overinflated tires may:

- increase the braking distance
- adversely affect handling
- wear excessively and/or unevenly
- have an adverse effect on ride comfort
- be more susceptible to damage

### Maximum tire pressures



- ① Example: maximum permissible tire pressure

Never exceed the maximum permissible tire inflation pressure. Always observe the recommended tire pressure for your vehicle when adjusting the tire pressure (> page 387).

- i** The actual values for tires are vehicle-specific and may deviate from the values in the illustration.

### Checking the tire pressures

#### Important safety notes

Observe the notes on tire pressure (> page 387).

Information on air pressure for the tires on your vehicle can be found:

- on the vehicle's Tire and Loading Information placard on the B-pillar (> page 394)
- in the tire pressure table in the fuel filler flap (> page 189)
- in the "Tire pressure" section

### Checking tire pressures manually

To determine and set the correct tire pressure, proceed as follows:

- ▶ Remove the valve cap of the tire that is to be checked.
- ▶ Press the tire pressure gage securely onto the valve.
- ▶ Read the tire pressure and compare it to the recommended value on the Tire and Loading Information placard or the tire pressure table (> page 387).
- ▶ If the tire pressure is too low, increase the tire pressure to the recommended value.
- ▶ If the tire pressure is too high, release air. To do so, press down the metal pin in the valve, using the tip of a pen for example. Then check the tire pressure again using the tire pressure checker.
- ▶ Screw the valve cap onto the valve.
- ▶ Repeat these steps for the other tires.

### Tire pressure monitor

#### General notes

If a tire pressure monitor is installed, the vehicle's wheels have sensors that monitor the tire pressures in all four tires. The tire pressure monitor warns you if the pressure drops in one or more of the tires. The tire pressure monitor only functions if the corresponding sensors are installed in all wheels.

Information on tire pressures is displayed in the multifunction display. After a few minutes of driving, the current tire pressure of each tire is shown in the **Service** menu of the multifunction display; see illustration (example).



For information on the message display, refer to the "Checking the tire pressure electronically" section (> page 392).



## Important safety notes

### WARNING

Each tire, including the spare (if provided), should be checked at least once every two weeks when cold and inflated to the pressure recommended by the vehicle manufacturer on the Tire and Loading Information placard on the driver's door B-pillar or the tire pressure label on the inside of the fuel filler flap. If your vehicle has tires of a different size than the size indicated on the Tire and Loading Information placard or, if available, the tire pressure label, you should determine the proper tire pressure for those tires.

As an added safety feature, your vehicle has been equipped with a tire pressure monitoring system (TPMS) that illuminates a low tire pressure telltale when one or more of your tires are significantly underinflated. Accordingly, when the low tire pressure telltale lights up, you should stop and check your tires as soon as possible, and inflate them to the proper pressure. Driving on a significantly underinflated tire causes the tire to overheat and can lead to tire failure.

Underinflation also reduces fuel efficiency and tire tread life, and may affect the vehicle's handling and stopping ability. Please note that the TPMS is not a substitute for proper tire maintenance, and it is the driver's responsibility to maintain correct tire pressure, even if underinflation has not reached the level to trigger illumination of the TPMS low tire pressure telltale.

Your vehicle has also been equipped with a TPMS malfunction indicator to indicate when the system is not operating properly. The TPMS malfunction indicator is combined with the low tire pressure telltale. When the system detects a malfunction, the warning lamp will flash for approximately a minute and then remain continuously illuminated. This sequence will be repeated every time the vehicle is started as long as the malfunction exists. When the malfunction indicator is illu-

minated, the system may not be able to detect or signal low tire pressure as intended.

TPMS malfunctions may occur for a variety of reasons, including the installation of incompatible replacement or alternate tires or wheels on the vehicle that prevent the TPMS from functioning properly. Always check the TPMS malfunction telltale after replacing one or more tires or wheels on your vehicle to ensure that the replacement or alternate Tires and wheels allow the TPMS to continue to function properly.

It is the driver's responsibility to set the tire pressure to that recommended for cold tires which is suitable for the operating situation (▷ page 387). Note that the correct tire pressure for the current operating situation must first be taught-in to the tire pressure monitor. If there is a substantial loss of pressure, the warning threshold for the warning message is aligned to the reference values taught-in. Restart the tire pressure monitor after adjusting the pressure of the cold tires (▷ page 392). The current pressures are saved as new reference values. As a result, a warning message will appear if the tire pressure drops significantly.

The tire pressure monitor does not warn you of an incorrectly set tire pressure. Observe the notes on the recommended tire pressure (▷ page 387).

The tire pressure monitor is not able to warn you of a sudden loss of pressure, e.g. if the tire is penetrated by a foreign object. In the event of a sudden loss of pressure, bring the vehicle to a halt by braking carefully. Avoid abrupt steering movements.

The tire pressure monitor has a yellow warning lamp in the instrument cluster for indicating pressure loss or a malfunction. Whether the warning lamp flashes or lights up indicates whether a tire pressure is too low or the tire pressure monitor is malfunctioning:

- if the warning lamp is lit continuously, the tire pressure on one or more tires is significantly too low. The tire pressure monitor is not malfunctioning.
- if the warning lamp flashes for around a minute and then remains lit constantly, the tire pressure monitor is malfunctioning.

In addition to the warning lamp, a message appears in the multifunction display. Observe





the information on display messages (> page 306).

It may take up to ten minutes for a malfunction of the tire pressure monitor to be indicated. A malfunction will be indicated by the tire pressure warning lamp flashing for approximately one minute and then remaining lit. When the malfunction has been rectified, the tire pressure warning lamp goes out after a few minutes of driving.

The tire pressure values indicated by the on-board computer may differ from those measured at a gas station with a pressure gauge. The tire pressures shown by the on-board computer refer to those measured at sea level. At high altitudes, the tire pressure values indicated by a pressure gauge are higher than those shown by the on-board computer. In this case, do not reduce the tire pressures.

The operation of the tire pressure monitor can be affected by interference from radio transmitting equipment (e.g. radio headphones, two-way radios) that may be being operated in or near the vehicle.

### Checking the tire pressure electronically

- ▶ Make sure that the SmartKey is in position 2 in the ignition lock (> page 162).
- ▶ Use  on the steering wheel to call up the list of menus.
- ▶ Press  or  on the steering wheel to select the **Service** menu.
- ▶ Press the **OK** button.
- ▶ Press  or  to select **Tire Pressure**.
- ▶ Press the **OK** button.

The current tire pressure of each tire is shown in the multifunction display.

If the vehicle was parked for longer than 20 minutes, the following message appears: **Tire pressure will be displayed after driving a few minutes.**

After a teach-in process, the tire pressure monitor automatically detects new wheels or new sensors. As long as a clear allocation of the tire pressure value to the individual wheels is not possible, the **Tire Pressure Monitor Active** message is shown instead of the tire pressure display. The tire pressures are already being monitored.

### Tire pressure monitor warning messages

If the tire pressure monitor detects a pressure loss in one or more tires, a warning message is shown in the multifunction display. The yellow tire pressure warning lamp then lights up.

- If the **Please Correct Tire Pressure** message appears in the multifunction display, the tire pressure in at least one tire is too low. The tire pressure must be corrected when the opportunity arises.
- If the **Check Tires** message appears in the multifunction display, the tire pressure in at least one tire has dropped significantly. The tires must be checked.
- If the **Warning Tire Malfunction** message appears in the multifunction display, the tire pressure in at least one tire has dropped suddenly. The tires must be checked.









Observe the instructions and safety notes in the display messages in the "Tires" section (> page 306).

If the wheel positions on the vehicle are rotated, the tire pressures may be displayed for the wrong positions for a short time. This is rectified after a few minutes of driving, and the tire pressures are displayed for the correct positions.

### Restarting the tire pressure monitor

When you restart the tire pressure monitor, all existing warning messages are deleted and the warning lamps go out. The monitor uses the currently set tire pressures as the reference values for monitoring. In most cases, the tire pressure monitor will automatically detect the new reference values after you have changed the tire pressure. However, you can also define reference values manually as described here. The tire pressure monitor then monitors the new tire pressure values.

- ▶ Set the tire pressure to the value recommended for the corresponding driving situation on the Tire and Loading Information placard on the driver's side B-pillar (> page 387).  
You can find more tire pressure values for various operating conditions in the tire pressure table inside the fuel filler flap (> page 387).
- ▶ Make sure that the tire pressure is correct on all four wheels.

- ▶ Make sure that the SmartKey is in position 2 in the ignition lock.
- ▶ Use  on the steering wheel to call up the list of menus.
- ▶ Press  or  on the steering wheel to select the **Service** menu.
- ▶ Press the  button.
- ▶ Press  or  to select **Tire Pressure**.
- ▶ Press the  button.  
The current tire pressure for each wheel or the **Tire pressure will be displayed after driving a few minutes** message will be displayed in the multifunction display.
- ▶ Press the  button.  
The **Use Current Pressures as New Reference Values** message appears in the multifunction display.

#### If you wish to confirm the restart:

- ▶ Press the  button.  
The **Tire Press. Monitor Restarted** message appears in the multifunction display.  
After driving for a few minutes, the system checks whether the current tire pressures are within the specified range. The new tire pressures are then accepted as reference values and monitored.

#### If you wish to cancel the restart:

- ▶ Press the  button.  
The tire pressure values stored at the last restart will continue to be monitored.

### Radio type approval for the tire pressure monitor

Country	Radio type approval number
USA	FCC ID: MRXMW2433A FCC ID: MRXGG4 FCC ID: MRXMC34MA4
Canada	IC: 2546A-MW2433A IC: 2546A-GG4 IC: 2546A-MC34MA4

### Tire pressure loss warning system (Canada only)

#### General notes

While the vehicle is in motion, the tire pressure loss warning system monitors the set tire pressure using the rotational speed of the wheels. This enables the system to detect significant pressure loss in a tire. If the speed of rotation of a wheel changes as a result of a loss of pressure, a corresponding warning message will appear in the multifunction display.

You can recognize the tire pressure loss warning by the **Run Flat Indicator Active Press 'OK' to Restart** message which appears in the **Service** menu of the multifunction display. Information on the message display can be found in the "Restarting the tire pressure loss warning system" section (▷ page 394).

#### Important safety notes

The tire pressure warning system does not warn you of an incorrectly set tire pressure. Observe the notes on the recommended tire pressure (▷ page 387).

The tire pressure loss warning does not replace the need to regularly check the tire pressure. An even loss of pressure on several tires at the same time cannot be detected by the tire pressure loss warning system.

The tire pressure monitor is not able to warn you of a sudden loss of pressure, e.g. if the tire is penetrated by a foreign object. In the event of a sudden loss of pressure, bring the vehicle to a halt by braking carefully. Avoid abrupt steering movements.

The function of the tire pressure loss warning system is limited or delayed if:







- snow chains are mounted on your vehicle's tires.
- road conditions are wintry.
- you are driving on sand or gravel.
- you adopt a very sporty driving style (cornering at high speeds or driving with high rates of acceleration).
- you are driving with a heavy load (in the vehicle or on the roof).

## Restarting the tire pressure loss warning system





Restart the tire pressure loss warning system if you have:

- changed the tire pressure
- changed the wheels or tires
- mounted new wheels or tires
- ▶ Before restarting, make sure that the tire pressures are set properly on all four tires for the respective operating conditions.

The recommended tire pressure can be found on the Tire and Loading Information placard on the B-pillar on the driver's side. Additionally, a tire pressure table is attached to the fuel filler flap. The tire pressure loss warning system can only give reliable warnings if you have set the correct tire pressure. If an incorrect tire pressure is set, these incorrect values will be monitored.





- ▶ Also observe the notes in the section on tire pressures (▷ page 387).
- ▶ Make sure that the SmartKey is in position **2** in the ignition lock (▷ page 162).
- ▶ Use  on the steering wheel to call up the list of menus.
- ▶ Press  or  on the steering wheel to select the **Service** menu.
- ▶ Press the  button.
- ▶ Press  or  to select **Tire Pressure**.
- ▶ Press the  button.  
The **Run Flat Indicator ActivePress 'OK' to Restart** message appears in the multifunction display.

### If you wish to confirm the restart:

- ▶ Press the  button.  
The **Tire Pressure Now OK?** message appears in the multifunction display.
- ▶ Press  or  to select **Yes**.
- ▶ Press the  button.  
The **Run Flat Indicator Restarted** message appears in the multifunction display.

After a teach-in period, the tire pressure loss warning system will monitor the set tire pressures of all four tires.

### If you wish to cancel the restart:

- ▶ Press the  button.
- or
- ▶ If the **Tire Pressure Now OK?** message appears, select **Cancel** by pressing  or .
- ▶ Press the  button.  
The tire pressure values stored at the last restart will continue to be monitored.

## Loading the vehicle

### Instruction labels for tires and loads

#### WARNING

Overloaded tires can overheat, causing a blowout. Overloaded tires can also impair the steering and driving characteristics and lead to brake failure. There is a risk of accident.

Observe the load rating of the tires. The load rating must be at least half of the GAWR of your vehicle. Never overload the tires by exceeding the maximum load.

Two instruction labels on your vehicle show the maximum possible load.

- (1) The Tire and Loading Information placard is on the B-pillar on the driver's side. The Tire and Loading Information placard shows the maximum permissible number of occupants and the maximum permissible vehicle load. It also contains details of the tire sizes and corresponding pressures for tires mounted at the factory.
- (2) The vehicle identification plate is on the B-pillar on the driver's side. The vehicle identification plate informs you of the gross vehicle weight rating. It is made up of the vehicle weight, all vehicle occupants, the fuel and the cargo. You can also find information about the maximum gross axle weight rating on the front and rear axle.  
The maximum gross axle weight rating is the maximum weight that can be carried by one axle (front or rear axle). Never exceed the maximum load or the maximum gross axle weight rating for the front or rear axle.



① B-pillar, driver's side

### Maximum permissible gross vehicle weight rating

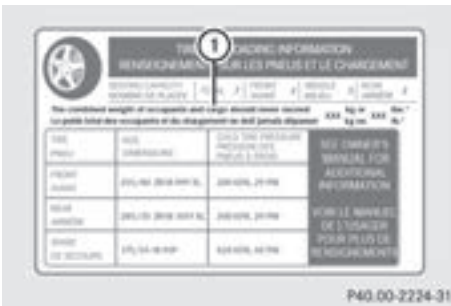

► Specification for maximum gross vehicle weight ① is listed in the Tire and Loading Information placard: "The combined weight of occupants and cargo should never exceed XXX kilograms or XXX lbs."

The gross weight of all vehicle occupants, load and luggage must not exceed the specified value.

① The specifications shown on the Tire and Loading Information placard in the illustration are examples. The maximum permissible gross vehicle weight rating is vehicle-specific and may differ from that in the illustration. You can find the valid maximum permissible gross vehicle weight rating for your vehicle on the Tire and Loading Information placard.

### Number of seats

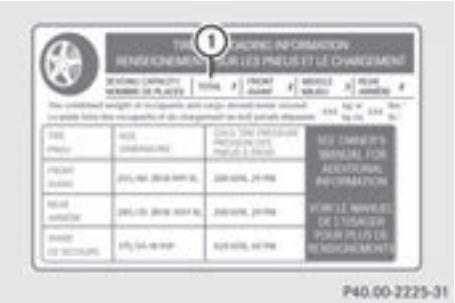

Maximum number of seats ① indicates the maximum number of occupants allowed to travel in the vehicle. This information can be found on the Tire and Loading Information placard.

① The specifications shown on the Tire and Loading Information placard in the illustration are examples. The number of seats is vehicle-specific and can differ from the details shown. The number of seats in your vehicle can be found on the Tire and Loading Information placard.

### Determining the correct load limit

#### Step-by-step instructions

The following steps have been developed as required of all manufacturers under Title 49, Code of U.S. Federal Regulations, Part 575 pursuant to the "National Traffic and Motor Vehicle Safety Act of 1966".

- **Step 1:** Locate the statement "The combined weight of occupants and cargo should never exceed XXX kg or XXX lbs." on your vehicle's Tire and Loading Information placard.
- **Step 2:** Determine the combined weight of the driver and passengers that will be riding in your vehicle.
- **Step 3:** Subtract the combined weight of the driver and passengers from XXX kilograms or XXX lbs.
- **Step 4:** The resulting figure equals the available amount of cargo and luggage load capacity. For example, if the "XXX" amount equals 1400 lbs and there will be five 150-lb passengers in your vehicle, the amount of avail-

able cargo and luggage load capacity is 650 lbs (1400 - 750 (5 x 150) = 650 lbs).

- ▶ **Step 5:** Determine the combined weight of luggage and cargo being loaded on the vehicle. That weight may not safely exceed the available cargo and luggage load capacity calculated in step 4.

**Example: steps 1 to 3**

The following table shows examples on how to calculate total and cargo load capacities with varying seating configurations and number and size of occupants. The following examples use a load limit of 1500 lbs (680 kg). **This is for illustration purposes only.** Make sure you are using the actual load limit for your vehicle stated on your vehicle's Tire and Loading Information placard (▷ page 394). The greater the combined weight of the occupants, the lower the maximum luggage load.

**Example 1**

## Step 1

- Combined maximum weight of occupants and load (data from the Tire and Loading Information placard): 1500 lbs (680 kg)

## Step 2

- Number of people in the vehicle (driver and occupants): 5
- Distribution of the occupants
  - Front: 2
  - Rear: 3
- Weight of the occupants
  - Occupant 1: 150 lbs (68 kg)
  - Occupant 2: 180 lbs (82 kg)
  - Occupant 3: 160 lbs (73 kg)
  - Occupant 4: 140 lbs (63 kg)
  - Occupant 5: 120 lbs (54 kg)
- Total weight of all occupants: 750 lbs (340 kg)

## Step 3

- Permissible load (maximum gross vehicle weight rating from the Tire and Loading Information placard minus the gross weight of all occupants):  
1500 lbs (680 kg) - 750 lbs (340 kg) = 750 lbs (340 kg)

**Example 2**

## Step 1

- Combined maximum weight of occupants and load (data from the Tire and Loading Information placard): 1500 lbs (680 kg)

## Step 2

- Number of people in the vehicle (driver and occupants): 3
- Distribution of the occupants
  - Front: 1
  - Rear: 2
- Weight of the occupants
  - Occupant 1: 200 lbs (91 kg)
  - Occupant 2: 190 lbs (86 kg)
  - Occupant 3: 150 lbs (68 kg)
- Total weight of all occupants: 540 lbs (245 kg)

## Step 3

- Permissible load (maximum gross vehicle weight rating from the Tire and Loading Information placard minus the gross weight of all occupants):  
1500 lbs (680 kg) - 540 lbs (245 kg) = 960 lbs (435 kg)

**Example 3**

## Step 1

- Combined maximum weight of occupants and load (data from the Tire and Loading Information placard): 1500 lbs (680 kg)

## Step 2

- Number of people in the vehicle (driver and occupants): 2
- Distribution of the occupants:
  - Front: 1
- Weight of the occupants
  - Occupant 1: 150 lbs (68 kg)
- Total weight of all occupants: 150 lbs (68 kg)

## Step 3

- Permissible load (maximum gross vehicle weight rating from the Tire and Loading Information placard minus the gross weight of all occupants):  
1500 lbs (680 kg) - 150 lbs (68 kg) = 1350 lbs (612 kg)

**Vehicle identification plate**

Even if you have calculated the total cargo carefully, you should still make sure that the gross vehicle weight rating and the gross axle weight rating are not exceeded. Details can be found on the vehicle identification plate on the B-pillar on the driver's side of the vehicle (> page 394).

**Permissible Gross Vehicle Weight Rating (GVWR):** the gross weight of the vehicle, all passengers, load and trailer load/noseweight (if applicable) must not exceed the permissible gross vehicle weight.

**Gross Axle Weight Rating (GAWR):** the maximum permissible weight that can be carried by one axle (front or rear axle).

To ensure that your vehicle does not exceed the maximum permissible values (gross vehicle weight and maximum gross axle weight rating), have your loaded vehicle (including driver, occupants, cargo, and full trailer load if applicable) weighed on a suitable vehicle weighbridge.

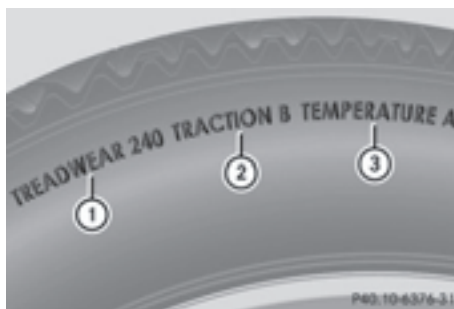
**All about wheels and tires****Uniform Tire Quality Grading Standards****Overview of Tire Quality Grading Standards**

Uniform Tire Quality Grading Standards are U.S. government specifications. Their purpose is to provide drivers with uniform reliable information on tire performance data. Tire manufacturers have to grade tires using three performance factors: ① tread wear grade, ② traction grade and ③ temperature grade. These regulations do not apply to Canada. Nevertheless, all tires sold in North America are provided with the corresponding quality grading markings on the sidewall of the tire.

Quality grades can be found, where applicable, on the tire sidewall between tread shoulder and maximum section width.



Example:

- **Treadwear grade:** 200
- **Traction grade:** AA
- **Temperature grade:** A

All passenger car tires must conform to the statutory safety requirements in addition to these grades.

**i** The actual values for tires are vehicle-specific and may deviate from the values in the illustration.

## Treadwear

The treadwear grade is a comparative rating based on the wear rate of the tire when tested under controlled conditions on a specified U.S. government course. For example, a tire graded 150 would wear one and one-half times as well on the government test track as a tire graded 100.

The relative performance of tires depends upon the actual conditions of their use, however, and may depart significantly from the norm due to variations in driving habits, service practices and differences in road characteristics and climate.

## Traction

### WARNING

The traction grade assigned to this tire is based on straight-ahead braking traction tests, and does not include acceleration, cornering, hydroplaning, or peak traction characteristics.

**!** Avoid wheelspin. This can lead to damage to the drive train.

The traction grades – from highest to lowest – are AA, A, B and C. Those grades represent the tire's ability to stop on wet pavement as measured under controlled conditions on specified government test surfaces of asphalt and concrete. A tire marked C may have poor traction performance.

The safe speed on a wet, snow covered or icy road is always lower than on dry road surfaces.

You should pay special attention to road conditions when temperatures are around freezing point.

Mercedes-Benz recommends a minimum tread depth of  $\frac{1}{8}$  in (4 mm) on all four winter tires. Observe the legally required minimum tire tread depth (▷ page 385). Winter tires can reduce the braking distance on snow-covered surfaces in comparison with summer tires. The braking distance is still much further than on surfaces that are not icy or covered with snow. Take appropriate care when driving.

Further information on winter tires (M+S tires) (▷ page 386).

## Temperature

### WARNING

The temperature grade for this tire is established for a tire that is properly inflated and not overloaded. Excessive speed, underinflation, or excessive loading, either separately or in combination, can cause excessive heat build-up and possible tire failure.

The temperature grades are A (the highest), B, and C, representing the tire's resistance to the generation of heat and its ability to dissipate heat when tested under controlled conditions on a specified indoor laboratory test wheel. Sustained high temperature can cause the material of the tire to degenerate and reduce tire life, and excessive temperature can lead to sudden tire failure. The grade C corresponds to a level of performance which all passenger car tires must meet under the Federal Motor Vehicle Safety Standard No. 109. Grades B and A represent higher levels of performance on the laboratory test wheel than the minimum required by law.

## Tire labeling

### Overview

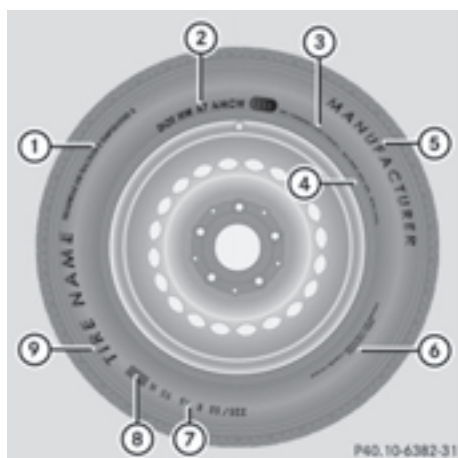

- ① Uniform Tire Quality Grading Standard (▷ page 403)
- ② DOT, Tire Identification Number (▷ page 402)
- ③ Maximum tire load (▷ page 402)
- ④ Maximum tire pressure (▷ page 390)
- ⑤ Manufacturer
- ⑥ Tire material (▷ page 403)
- ⑦ Tire size designation, load-bearing capacity and speed rating (▷ page 400)
- ⑧ Load index (▷ page 402)
- ⑨ Tire name

The markings described above are on the tire in addition to the tire name (sales designation) and the manufacturer's name.

- ⓘ Tire data is vehicle-specific and may deviate from the data in the example.

### Tire size designation, load-bearing capacity and speed rating

#### ⚠ WARNING

Exceeding the stated tire load-bearing capacity and the approved maximum speed could lead to tire damage or the tire bursting. There is a risk of accident.

Therefore, only use tire types and sizes approved for your vehicle model. Observe the

tire load rating and speed rating required for your vehicle.



**General:** depending on the manufacturer's standards, the size imprinted in the tire wall may not contain any letters or may contain one letter that precedes the size description.

If there is no letter preceding the size description (as shown above): these are passenger vehicle tires according to European manufacturing standards.

If "P" precedes the size description: these are passenger vehicle tires according to U.S. manufacturing standards.

If "LT" precedes the size description: these are light truck tires according to U.S. manufacturing standards.

If "T" precedes the size description: compact emergency wheels with high tire pressure that are only designed for temporary use in an emergency.

**Tire width:** tire width ① shows the nominal tire width in millimeters.

**Height-width ratio:** aspect ratio ② is the size ratio between the tire height and tire width and is shown in percent. The aspect ratio is calculated by dividing the tire width by the tire height.

**Tire code:** tire code ③ specifies the tire type. "R" represents radial tires; "D" represents diagonal tires; "B" represents diagonal radial tires.

Optionally, tires with a maximum speed of over 149 mph (240 km/h) may have "ZR" in the size description, depending on the manufacturer (e.g. 245/40 ZR 18).

**Rim diameter:** rim diameter ④ is the diameter of the bead seat, not the diameter of the rim flange. The rim diameter is specified in inches (in).

**Load-bearing index:** load-bearing index ⑤ is a numerical code that specifies the maximum load-bearing capacity of a tire.

Do not overload the tires by exceeding the specified load limit. The maximum permissible load can be found on the vehicle's Tire and Loading Information placard on the B-pillar on the driver's side (▷ page 394).

Example:

Load-bearing index 91 indicates a maximum load of 1,356 lb (615 kg) that the tires can bear. For further information on the maximum tire load in kilograms and lbs, see (▷ page 402). For further information on the load bearing index, see "Load index" (▷ page 402).

**Speed rating:** speed rating ⑥ specifies the approved maximum speed of the tire.

**i** Tire data is vehicle-specific and may deviate from the data in the example.

Regardless of the speed rating, always observe the speed limits. Drive carefully and adapt your driving style to the traffic conditions.

### Summer tires

Index	Speed rating
Q	up to 100 mph (160 km/h)
R	up to 106 mph (170 km/h)
S	up to 112 mph (180 km/h)
T	up to 118 mph (190 km/h)
H	up to 130 mph (210 km/h)
V	up to 149 mph (240 km/h)
W	up to 168 mph (270 km/h)
Y	up to 186 mph (300 km/h)
ZR...Y	up to 186 mph (300 km/h)
ZR...(..Y)	over 186 mph (300 km/h)
ZR	over 149 mph (240 km/h)

- Optionally, tires with a maximum speed of over 149 mph (240 km/h) may have "ZR" in the size description, depending on the manufacturer (e.g. 245/40 ZR18).

The service specification is made up of load-bearing index ⑤ and speed rating ⑥.

- If the size description of your tire includes "ZR" and there are no service specifications, ask the tire manufacturer in order to find out the maximum speed.

If a service specification is available, the maximum speed is limited according to the speed rating in the service specification. Example: 245/40 ZR18 97 Y. In this example, "97 Y" is the service specification. The letter "Y" represents the speed rating. The maximum speed of the tire is limited to 186 mph (300 km/h).

- The size description for all tires with maximum speeds of over 186 mph (300 km/h) must include "ZR", **and** the service specification must be given in parentheses. Example: 275/40 ZR 18 (99 Y). Speed rating "Y" indicates that the maximum speed of the tire is over 186 mph (300 km/h). Ask the tire manufacturer about the maximum speed.

### All-weather tires and winter tires

Index	Speed rating
Q M+S <sup>1</sup>	up to 100 mph (160 km/h)
T M+S <sup>1</sup>	up to 118 mph (190 km/h)
H M+S <sup>1</sup>	up to 130 mph (210 km/h)
V M+S <sup>1</sup>	up to 149 mph (240 km/h)

**i** Not all tires with the M+S marking provide the driving characteristics of winter tires. In addition to the M+S marking, winter tires also have the  snowflake symbol on the tire wall. Tires with this marking fulfill the requirements of the Rubber Manufacturers Association (RMA) and the Rubber Association of Canada (RAC) regarding the tire traction on snow. They have been especially developed for driving on snow.

An electronic speed limiter prevents your vehicle from exceeding a speed of 130 mph (210 km/h).

The speed rating of tires mounted at the factory may be higher than the maximum speed that the electronic speed limiter permits.

Make sure that your tires have the required speed rating, e.g. when buying new tires. The

<sup>1</sup> Or M+S  for winter tires.

required speed rating for your vehicle can be found in the "Tires" section (▷ page 410).

Further information about reading tire data can be obtained from any qualified specialist workshop.

### Load index



In addition to the load-bearing index, load index ① may also be imprinted on the sidewall of the tire. You will find this after the letter that identifies the speed rating (▷ page 400).

- If no specification is given: no text (as in the example above), represents a standard load (SL) tire
- XL or Extra Load: represents a reinforced tire
- Light Load: represents a light load tire
- C, D, E: represents a load range that depends on the maximum load that the tire can carry at a certain pressure

**i** Tire data is vehicle-specific and may deviate from the data in the example.

### Maximum load rating

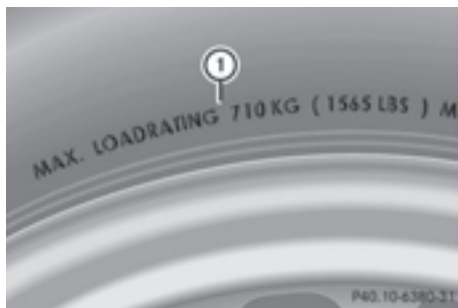

Maximum tire load ① is the maximum permissible weight for which the tire is approved.

Do not overload the tires by exceeding the specified load limit. The maximum permissible load can be found on the vehicle's Tire and Loading Information placard on the B-pillar on the driver's side (▷ page 394).

**i** The actual values for tires are vehicle-specific and may deviate from the values in the illustration.

### DOT, Tire Identification Number (TIN)

US tire regulations stipulate that every tire manufacturer or retreader must imprint a TIN in or on the sidewall of each tire produced.

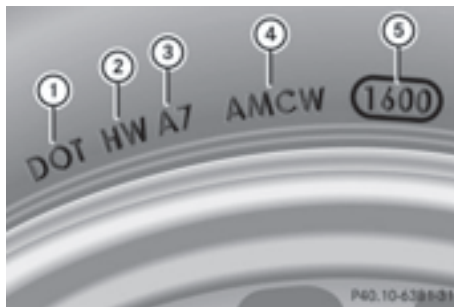

The TIN is a unique identification number. The TIN enables the tire manufacturers or retreaders to inform purchasers of recalls and other safety-relevant matters. It makes it possible for the purchaser to easily identify the affected tires.

The TIN is made up of manufacturer identification code ②, tire size ③, tire type code ④ and manufacturing date ⑤.

**DOT (Department of Transportation):** tire symbol ① marks that the tire complies with the requirements of the U.S. Department of Transportation.

**Manufacturer identification code:** manufacturer identification code ② provides details on the tire manufacturer. New tires have a code with two symbols. Retreaded tires have a code with four symbols.

For further information about retreaded tires, see (▷ page 410).

**Tire size:** identifier ③ describes the tire size.

**Tire type code:** tire type code ④ can be used by the manufacturer as a code to describe specific characteristics of the tire.

**Date of manufacture:** date of manufacture ⑤ provides information about the age of a tire. The first and second positions represent the week of

manufacture, starting with "01" for the first calendar week. Positions three and four represent the year of manufacture. For example, a tire that is marked with "3208", was manufactured in week 32 in 2008.

- ① Tire data is vehicle-specific and may deviate from the data in the example.

## Tire characteristics

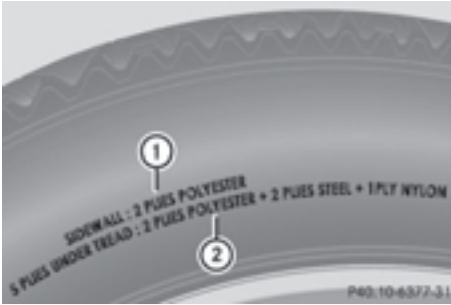

This information describes the type of tire cord and the number of layers in sidewall ① and under tire tread ②.

- ① Tire data is vehicle-specific and may deviate from the data in the example.

## Definition of terms for tires and loading

### Tire ply composition and material used

Describes the number of plies or the number of layers of rubber-coated fabric in the tire tread and sidewall. These are made of steel, nylon, polyester and other materials.

### Bar

Metric unit for tire pressure. 14.5038 pounds per square inch (psi) and 100 kilopascals (kPa) are the equivalent of 1 bar.

### DOT (Department of Transportation)

DOT-marked tires fulfill the requirements of the U S Department of Transportation.

### Normal occupant weight

The number of occupants for which the vehicle is designed multiplied by 68 kilograms (150 lbs).

## Uniform Tire Quality Grading Standards

A uniform standard to grade the quality of tires with regards to tread quality, tire traction and temperature characteristics. The quality grading assessment is made by the manufacturer following specifications from the U.S. government. The ratings are molded into the sidewall of the tire.

## Recommended tire pressures

The recommended tire pressure applies to the tires mounted at the factory.

The Tire and Loading Information placard contains the recommended tire pressures for cold tires on a fully loaded vehicle and for the maximum permissible vehicle speed.

The tire pressure table contains the recommended pressures for cold tires for various operating conditions, i.e. differing load and speed conditions.

## Increased vehicle weight due to optional equipment

The combined weight of all standard and optional equipment available for the vehicle, regardless of whether it is actually installed on the vehicle or not.

### Rim

This is the part of the wheel on which the tire is mounted.

## GAWR (Gross Axle Weight Rating)

The GAWR is the maximum gross axle weight rating. The actual load on an axle must never exceed the gross axle weight rating. The gross axle weight rating can be found on the vehicle identification plate on the B-pillar on the driver's side.

## Speed rating

The speed rating is part of the tire identification. It specifies the speed range for which the tire is approved.

## GVW (Gross Vehicle Weight)

The gross vehicle weight includes the weight of the vehicle including fuel, tools, the spare wheel, accessories installed, occupants, luggage and the drawbar noseweight, if applicable. The gross vehicle weight must not exceed the gross vehicle weight rating GVWR as specified on the vehicle identification plate on the B-pillar on the driver's side.

**GVWR (Gross Vehicle Weight Rating)**

The GVWR is the maximum permissible gross weight of a fully loaded vehicle (the weight of the vehicle including all accessories, occupants, fuel, luggage and the drawbar noseweight, if applicable). The gross vehicle weight rating is specified on the vehicle identification plate on the B-pillar on the driver's side.

**Maximum loaded vehicle weight**

The maximum weight is the sum of:

- the curb weight of the vehicle
- the weight of the accessories
- the load limit
- the weight of the factory installed optional equipment

**Kilopascal (kPa)**

Metric unit for tire pressure. 6.9 kPa corresponds to 1 psi. Another unit for tire pressure is bar. 100 kilopascals (kPa) are the equivalent of 1 bar.

**Load index**

In addition to the load-bearing index, the load index may also be imprinted on the sidewall of the tire. This specifies the load-bearing capacity more precisely.

**Curb weight**

The weight of a vehicle with standard equipment including the maximum capacity of fuel, oil and coolant. It also includes the air-conditioning system and optional equipment if these are installed in the vehicle, but does not include passengers or luggage.

**Maximum load rating**

The maximum tire load is the maximum permissible weight in kilograms or lbs for which a tire is approved.

**Maximum permissible tire pressure**

Maximum permissible tire pressure for one tire.

**Maximum load on one tire**

Maximum load on one tire. This is calculated by dividing the maximum axle load of one axle by two.

**PSI (pounds per square inch)**

A standard unit of measure for tire pressure.

**Aspect ratio**

Relationship between tire height and tire width in percent.

**Tire pressure**

This is pressure inside the tire applying an outward force to each square inch of the tire's surface. The tire pressure is specified in pounds per square inch (psi), in kilopascal (kPa) or in bar. The tire pressure should only be corrected when the tires are cold.

**Cold tire pressure**

The tires are cold:

- if the vehicle has been parked with the tires out of direct sunlight for at least three hours and
- if the vehicle has not been driven further than 1 mile (1.6 km)

**Tread**

The part of the tire that comes into contact with the road.

**Bead**

The tire bead ensures that the tire sits securely on the wheel. There are several steel wires in the bead to prevent the tire from coming loose from the wheel rim.

**Sidewall**

The part of the tire between the tread and the bead.

**Weight of optional extras**

The combined weight of those optional extras that weigh more than the replaced standard parts and more than 5 lbs (2.3 kg). These optional extras, such as high-performance brakes, level control, a roof rack or a high-performance battery, are not included in the curb weight and the weight of the accessories.

**TIN (Tire Identification Number)**

This is a unique identifier which can be used by a tire manufacturer to identify tires, for example for a product recall, and thus identify the purchasers. The TIN is made up of the manufacturer's identity code, tire size, tire type code and the manufacturing date.

## Load bearing index

The load bearing index (also load index) is a code that contains the maximum load bearing capacity of a tire.

## Traction

Traction is the result of friction between the tires and the road surface.

## Treadwear indicators

Narrow bars (tread wear bars) that are distributed over the tire tread. If the tire tread is level with the bars, the wear limit of  $\frac{1}{16}$  in (1.6 mm) has been reached.

## Occupant distribution

The distribution of occupants in a vehicle at their designated seating positions.

## Total load limit

Nominal load and luggage load plus 68 kg (150 lbs) multiplied by the number of seats in the vehicle.

## Changing a wheel

### Flat tire

The "Breakdown assistance" section (▷ page 367) contains information and notes on how to deal with a flat tire. Information on driving with MOExtended tires in the event of a flat tire can be found under "MOExtended tires (tires with run-flat characteristics)" (▷ page 368).

### Rotating the wheels

#### WARNING

Interchanging the front and rear wheels may severely impair the driving characteristics if the wheels or tires have different dimensions. The wheel brakes or suspension components may also be damaged. There is a risk of accident.

Rotate front and rear wheels only if the wheels and tires are of the same dimensions.

**!** On vehicles equipped with a tire pressure monitor, electronic components are located in the wheel.

Tire-mounting tools should not be used near the valve. This could damage the electronic components.

Only have tires changed at a qualified specialist workshop.

Always observe the instructions and safety notes in the "Mounting a wheel" section (▷ page 406).

The wear patterns on the front and rear tires differ, depending on the operating conditions. Rotate the wheels before a clear wear pattern has formed on the tires. Front tires typically wear more on the shoulders and the rear tires in the center.

On vehicles that have the same size front and rear wheels, you can rotate the wheels according to the intervals in the tire manufacturer's warranty book in your vehicle documents. If no warranty book is available, the tires should be rotate every 3,000 to 6,000 miles (5,000 to 10,000 km). Earlier may be necessary, depending on the degree of tire wear. Do not change the direction of wheel rotation.

Clean the contact surfaces of the wheel and the brake disc thoroughly every time a wheel is rotated. Check the tire pressure and, if necessary, restart the tire pressure loss warning system (▷ page 394) or the tire pressure monitor (▷ page 392).

### Direction of rotation

Tires with a specified direction of rotation have additional benefits, e.g. if there is a risk of hydroplaning. These advantages can only be gained if the tires are installed corresponding to the direction of rotation.

An arrow on the sidewall of the tire indicates its correct direction of rotation.

### Storing wheels

Store wheels that are not being used in a cool, dry and preferably dark place. Protect the tires from oil, grease, gasoline and diesel.

## Mounting a wheel

### Preparing the vehicle

- ▶ Stop the vehicle on solid, non-slippery and level ground.
- ▶ Apply the electric parking brake manually.
- ▶ Bring the front wheels into the straight-ahead position.
- ▶ Shift the transmission to position **P**.
- ▶ Make sure that "normal" level is selected for AIRMATIC (▷ page 212) or Active Body Control (ABC) (▷ page 210).
- ▶ Switch off the engine.
- ▶ Open the driver's door.  
The on-board electronics now have status **O**. This is the same as the SmartKey having been removed.
- ▶ Remove Start/Stop button from ignition lock (▷ page 162).

or, if the SmartKey is inserted in the ignition lock:

- ▶ Remove the SmartKey from the ignition lock.
- ▶ Make sure that the engine cannot be started via your smartphone (▷ page 164).
- ▶ If included in the vehicle equipment, remove the tire-change tool kit from the vehicle.
- ▶ Safeguard the vehicle against rolling away.

### Securing the vehicle to prevent it from rolling away

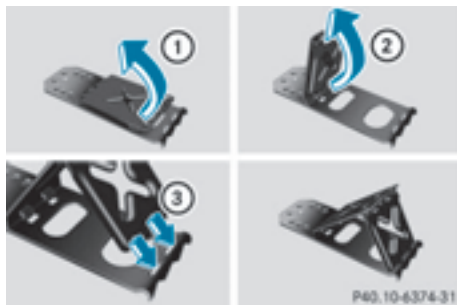

If your vehicle is equipped with a wheel chock, it can be found in the tire-change tool kit (▷ page 367).

The folding wheel chock is an additional safety measure to prevent the vehicle from rolling away, for example when changing a wheel.

- ▶ Fold both plates upwards ①.
- ▶ Fold out lower plate ②.
- ▶ Guide the lugs on the lower plate fully into the openings in base plate ③.



- ▶ Place chocks or other suitable items under the front and rear of the wheel that is diagonally opposite the wheel you wish to change.

### Raising the vehicle

#### **WARNING**

If you do not position the jack correctly at the appropriate jacking point of the vehicle, the jack could tip over with the vehicle raised. There is a risk of injury.

Only position the jack at the appropriate jacking point of the vehicle. The base of the jack must be positioned vertically, directly under the jacking point of the vehicle.

- ❗ The jack is designed exclusively for jacking up the vehicle at the jacking points. Otherwise, your vehicle could be damaged.

#### **Observe the following when raising the vehicle:**

- To raise the vehicle, only use the vehicle-specific jack that has been tested and approved by Mercedes-Benz. If used incorrectly, the jack could tip over with the vehicle raised.
- The jack is designed only to raise and hold the vehicle for a short time while a wheel is being changed. It must not be used for performing maintenance work under the vehicle.
- Avoid changing the wheel on uphill and downhill slopes.
- Before raising the vehicle, secure it from rolling away by applying the parking brake and



inserting wheel chocks. Do not disengage the parking brake while the vehicle is raised.

- The jack must be placed on a firm, flat and non-slip surface. On a loose surface, a large, flat, load-bearing underlay must be used. On a slippery surface, a non-slip underlay must be used, e.g. rubber mats.
- Do not use wooden blocks or similar objects as a jack underlay. Otherwise, the jack will not be able to achieve its load-bearing capacity due to the restricted height.
- Make sure that the distance between the underside of the tires and the ground does not exceed 1.2 in (3 cm).
- Never place your hands and feet under the raised vehicle.
- Do not lie under the vehicle.
- Do not start the engine when the vehicle is raised.
- Do not open or close a door or the trunk lid when the vehicle is raised.
- Make sure that no persons are present in the vehicle when the vehicle is raised.

**Vehicles with AMG wheels and hub caps:** the hub cap covers the wheel bolts. Before you can unscrew the wheel bolts, you must remove the hub cap. Two different variants can be installed.



**Vehicles with AMG wheels and plastic hub caps:**

- ▶ **To remove:** turn the center cover of hub cap ① counter-clockwise and remove.
- ▶ **To install:** before installing, ensure that hub cap ① is in the open position. To do this, turn the center cover counter-clockwise.
- ▶ Position hub cap ① and turn the center cover clockwise until hub cap ① engages physically and audibly.
- ▶ Make sure that hub cap ① is installed securely.



**Vehicles with AMG wheels and aluminum hub caps:**

- ▶ **To remove:** take socket ② and lug wrench ③ from the vehicle tool kit (> page 367).
  - ▶ Position socket ② on hub cap ①.
  - ▶ Position lug wrench ③ on socket ②.
  - ▶ Using lug wrench ③, turn hub cap ① counter-clockwise and remove it.
  - ▶ **To install:** before installing, check hub cap ① and the wheel area for soiling and clean if necessary.
  - ▶ Put hub cap ① in position and turn until it is in the right position.
  - ▶ Position socket ② on hub cap ①.
  - ▶ Attach lug wrench ③ to socket ② and tighten hub cap ①.
- The tightening torque must be **18 lb-ft (25 Nm)**.

**i Note** that the hub cap should be tightened to the specified torque of **18 lb-ft (25 Nm)**. Mercedes-Benz recommends that you have the hub cap installed at a qualified specialist workshop.

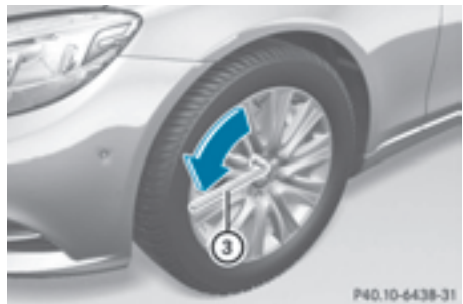

- ▶ Using lug wrench ③, loosen the bolts on the wheel you wish to change by about one full turn. Do not unscrew the bolts completely.

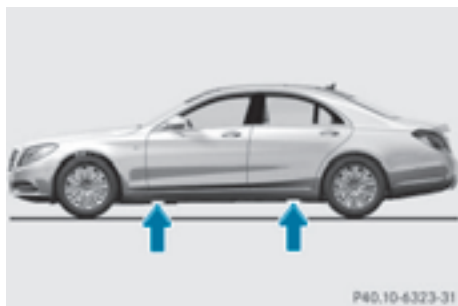

The jacking points are located just behind the front wheel housings and just in front of the rear wheel housings (arrows).

- ▶ Take the ratchet wrench out of the vehicle tool kit and place it on the hexagon nut of the jack so that the letters **AUF** are visible.

**Mercedes-AMG vehicles and vehicles with AMG equipment:** to protect the vehicle body, the vehicle has covers installed next to the jacking points on the outer sills.

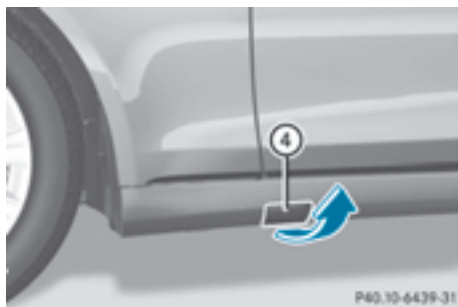

- ▶ **Mercedes-AMG vehicles and vehicles with AMG equipment:** fold cover (4) upwards.

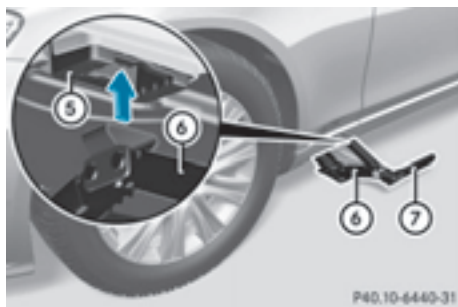

- ▶ Position jack (6) at jacking point (5).

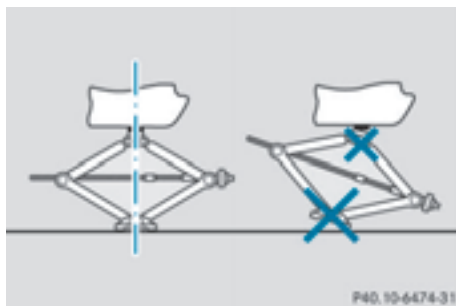

- ▶ Make sure the foot of the jack is directly beneath the jacking point.
- ▶ Turn ratchet wrench (7) until jack (6) sits completely on jacking point (5) and the base of the jack lies evenly on the ground.
- ▶ Turn ratchet wrench (7) until the tire is raised a maximum of 1.2 in (3 cm) from the ground.

## Removing a wheel

**Mercedes-AMG vehicles:** during removal and repositioning of the wheel, the wheel rim can strike the ceramic-brake disc and damage it. Therefore, you should proceed carefully and get a second person assist to you. Alternatively, you can use a second alignment bolt.

**!** Do not place wheel bolts in sand or on a dirty surface. The bolt and wheel hub threads could otherwise be damaged when you screw them in.

When mounting/removing wheels, and for as long as the wheels are removed, avoid applying any external force on the brake disks. This could impair the level of comfort when braking.



- ▶ Unscrew the uppermost wheel bolt completely.
- ▶ Screw alignment bolt ① into the thread instead of the wheel bolt.
- ▶ Unscrew the remaining wheel bolts fully.
- ▶ Remove the wheel.

### Mounting a new wheel

#### WARNING

Oiled or greased wheel bolts or damaged wheel bolts/hub threads can cause the wheel bolts to come loose. As a result, you could lose a wheel while driving. There is a risk of accident.

Never oil or grease wheel bolts. In the event of damage to the threads, contact a qualified specialist workshop immediately. Have the damaged wheel bolts or hub threads replaced/renewed. Do not continue driving.

#### WARNING

If you tighten the wheel bolts or wheel nuts when the vehicle is raised, the jack could tip over. There is a risk of injury.

Only tighten the wheel bolts or wheel nuts when the vehicle is on the ground.

Always pay attention to the instructions and safety notes in the "Changing a wheel" section (▷ page 405).

Only use wheel bolts that have been designed for the wheel and the vehicle. For safety reasons, Mercedes-Benz recommends that you only use wheel bolts which have been approved for Mercedes-Benz vehicles and the respective wheel.

**!** **Mercedes-AMG vehicles:** during removal and repositioning of the wheel, the wheel rim can strike the ceramic-brake disc and damage it. Therefore, you should proceed carefully and get a second person assist to you. Alternatively, you can use a second alignment bolt.

**!** To prevent damage to the paintwork, hold the wheel securely against the wheel hub while screwing in the first wheel bolt.

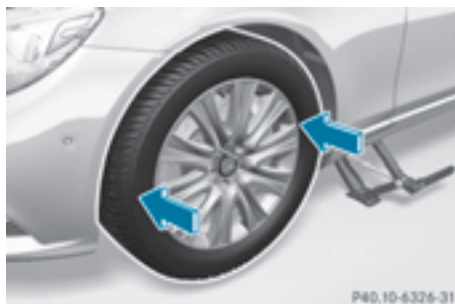

- ▶ Clean the wheel and wheel hub contact surfaces.
- ▶ Slide the wheel to be mounted onto the alignment bolt and push it on.
- ▶ Tighten the wheel bolts until they are finger-tight.
- ▶ Unscrew the alignment bolt.
- ▶ Tighten the last wheel bolt until it is finger-tight.

### Lowering the vehicle

#### WARNING

The wheels could work loose if the wheel nuts and bolts are not tightened to the specified tightening torque. There is a risk of accident.

Have the tightening torque immediately checked at a qualified specialist workshop after a wheel is changed.

- ▶ Place the ratchet wrench onto the hexagon nut of the jack so that the letters **AB** are visible.
- ▶ Turn the ratchet wrench until the vehicle is once again standing firmly on the ground.
- ▶ Place the jack to one side.



- ▶ Tighten the wheel bolts evenly in a crosswise pattern in the sequence indicated (① to ⑤). The tightening torque must be **110 lb-ft (150 Nm)**.
- ▶ Turn the jack back to its initial position.
- ▶ Stow the jack and the rest of the vehicle tools in the trunk again.
- ▶ **Mercedes-AMG vehicles and vehicles with AMG equipment:** insert the cover into the outer sill.
- ▶ Check the tire pressure of the newly mounted wheel and adjust it if necessary. Observe the recommended tire pressure (> page 387).

**i** Vehicles with a tire pressure control system: all mounted wheels must be equipped with functioning tire pressure control sensors.

## Wheel and tire combinations

### General notes

**!** For safety reasons, Mercedes-Benz recommends that you only use tires and wheels which have been approved by Mercedes-Benz specifically for your vehicle.

These tires have been specially adapted for use with the control systems, such as ABS or ESP®, and are marked as follows:

- MO = Mercedes-Benz Original
- MOE = Mercedes-Benz Original Extended (tires featuring run-flat characteristics)
- MO1 = Mercedes-Benz Original (only certain AMG tires)

Mercedes-Benz Original Extended tires may only be used on wheels that have been specifically approved by Mercedes-Benz.

Only use tires, wheels or accessories tested and approved by Mercedes-Benz. Certain characteristics, e.g. handling, vehicle noise emissions or fuel consumption, may otherwise be adversely affected. In addition, when driving with a load, tire dimension variations could cause the tires to come into contact with the bodywork and axle components. This could result in damage to the tires or the vehicle.

Mercedes-Benz accepts no liability for damage resulting from the use of tires, wheels or

accessories other than those tested and approved.

Information on tires, wheels and approved combinations can be obtained from any qualified specialist workshop.

**!** Retreaded tires are neither tested nor recommended by Mercedes-Benz, since previous damage cannot always be detected on retreaded tires. As a result, Mercedes-Benz cannot guarantee vehicle safety if retreaded tires are mounted. Do not mount used tires if you have no information about their previous usage.

Overview of abbreviations used in the following tire tables:

- BA: both axles
- FA: front axle
- RA: rear axle

The recommended pressures for various operating conditions can be found:

- on the Tire and Loading Information placard on the B-pillar on the driver's side
- in the tire pressure table in the fuel filler flap

Observe the notes on recommended tire pressures under various operating conditions (> page 387).

Check tire pressures regularly, and only when the tires are cold. Comply with the maintenance recommendations of the tire manufacturer in the vehicle document wallet.

Notes on the vehicle equipment – always equip the vehicle with:

- with tires of the same size on a given axle (left and right)
- the same type of tires at a given time (summer tires, winter tires, MOExtended tires)

Exception: it is permissible to install a different type or make in the event of a flat tire.

Observe the "MOExtended tires (tires with run-flat characteristics" section (> page 368).

Vehicles equipped with MOExtended tires are not equipped with a TIREFIT kit at the factory. It is therefore recommended that you additionally equip your vehicle with a TIREFIT kit if you mount tires that do not feature run-flat properties, e.g. winter tires. A TIREFIT kit may be obtained from a qualified specialist workshop.

**i** Not all wheel and tire combinations are available at the factory for all countries.

**i** The following pages contain information on approved wheel rims and tire sizes for equipping your vehicle with winter tires. Winter tires are not available at the factory as standard equipment or optional extras.

If you want to equip your vehicle with approved winter tires, it may be necessary to obtain wheel rims in the corresponding size. The size of the approved winter tires may differ from the standard tires. This is dependent on the model and the equipment installed at the factory.

The tires and wheel rims, as well as further information, can be obtained at a qualified specialist workshop.

## Tires

## S 400 4MATIC

## Summer tires

## R18

Tires	Wheels
BA: 245/50 R18 100 W	BA: 8.0 J x 18 H2 Wheel offset: 1.61 in (41 mm)

## R19

Tires	Wheels
FA: 245/45 R19 102 Y XL RA: 275/40 R19 (101 Y) XL <sup>2</sup>	FA: 8.5 J x 19 H2 Wheel offset: 1.42 in (36 mm) RA: 9.5 J x 19 H2 Wheel offset: 1.71 in (43.5 mm)
FA: 245/45 R19 102 Y XL RA: 275/40 R19 101 Y <sup>2</sup>	FA: 8.5 J x 19 H2 Wheel offset: 1.50 in (38 mm) <sup>5</sup> RA: 9.5 J x 19 H2 Wheel offset: 1.50 in (38 mm) <sup>5</sup>

## R20

Tires	Wheels
FA: 245/40 R20 99 Y XL <sup>3, 4</sup> RA: 275/35 R20 102 Y XL <sup>2, 3, 4</sup>	FA: 8.5 J x 20 H2 Wheel offset: 1.42 in (36 mm) RA: 9.5 J x 20 H2 Wheel offset: 1.71 in (43.5 mm)
FA: 245/40 R20 99 Y XL <sup>3, 4</sup> RA: 275/35 R20 102 Y XL <sup>2, 3, 4</sup>	FA: 8.5 J x 20 H2 Wheel offset: 1.44 in (36.5 mm) RA: 9.5 J x 20 H2 Wheel offset: 1.73 in (44 mm)
FA: 245/40 R20 99 Y XL <sup>3</sup> RA: 275/35 R20 102 Y XL <sup>2, 3</sup>	FA: 8.5 J x 20 H2 Wheel offset: 1.50 in (38 mm) <sup>5</sup> RA: 9.5 J x 20 H2 Wheel offset: 1.50 in (38 mm) <sup>5</sup>

<sup>2</sup> Use of snow chains not permitted. Observe the notes in the "Snow chains" section.

<sup>5</sup> Only in conjunction with AMG line (code 951).

<sup>3</sup> Available as MOExtended tires

<sup>4</sup> Not in conjunction with AMG line (code 951).

**All-weather tires****R18**

Tires	Wheels
BA: 245/50 R18 100 H M+S <sup>3,4</sup>	BA: 8.0 J x 18 H2 Wheel offset: 1.61 in (41 mm)

**R19**

Tires	Wheels
FA: 245/45 R19 102 H XL M+S <sup>3,4</sup> RA: 275/40 R19 101 H M+S <sup>2,3,4</sup>	FA: 8.5 J x 19 H2 Wheel offset: 1.42 in (36 mm) RA: 9.5 J x 19 H2 Wheel offset: 1.71 in (43.5 mm)
FA: 245/45 R19 102 H XL M+S <sup>3</sup> RA: 275/40 R19 101 H M+S <sup>2,3</sup>	FA: 8.5 J x 19 H2 Wheel offset: 1.50 in (38 mm) <sup>5</sup> RA: 9.5 J x 19 H2 Wheel offset: 1.50 in (38 mm) <sup>5</sup>

**Winter tires****R18**

Tires	Wheels
BA: 245/50 R18 104 V XL M+S  <sup>3</sup>	BA: 8.0 J x 18 H2 Wheel offset: 1.61 in (41 mm)

**R19**

Tires	Wheels
BA: 245/45 R19 102 V XL M+S  <sup>3</sup>	BA: 8.5 J x 19 H2 Wheel offset: 1.42 in (36 mm)
BA: 245/45 R19 102 V XL M+S  <sup>3</sup>	BA: 8.5 J x 19 H2 Wheel offset: 1.50 in (38 mm) <sup>5</sup>

<sup>3</sup> Available as MOExtended tires

<sup>4</sup> Not in conjunction with AMG line (code 951).

<sup>2</sup> Use of snow chains not permitted. Observe the notes in the "Snow chains" section.

<sup>5</sup> Only in conjunction with AMG line (code 951).

**S 550****Summer tires****R18**

Tires	Wheels
BA: 245/50 R18 100 W	BA: 8.0 J x 18 H2 Wheel offset: 1.61 in (41 mm)

**R19**

Tires	Wheels
FA: 245/45 R19 102 Y XL RA: 275/40 R19 101 Y <sup>2</sup>	FA: 8.5 J x 19 H2 Wheel offset: 1.42 in (36 mm) RA: 9.5 J x 19 H2 Wheel offset: 1.71 in (43.5 mm)
FA: 245/45 R19 102 Y XL RA: 275/40 R19 101 Y <sup>2</sup>	FA: 8.5 J x 19 H2 Wheel offset: 1.50 in (38 mm) <sup>5</sup> RA: 9.5 J x 19 H2 Wheel offset: 1.50 in (38 mm) <sup>5</sup>

**R20**

Tires	Wheels
FA: 245/40 R20 99 Y XL <sup>3, 4</sup> RA: 275/35 R20 102 Y XL <sup>2, 3, 4</sup>	FA: 8.5 J x 20 H2 Wheel offset: 1.42 in (36 mm) RA: 9.5 J x 20 H2 Wheel offset: 1.71 in (43.5 mm)
FA: 245/40 R20 99 Y XL <sup>3, 4</sup> RA: 275/35 R20 102 Y XL <sup>2, 3, 4</sup>	FA: 8.5 J x 20 H2 Wheel offset: 1.44 in (36.5 mm) RA: 9.5 J x 20 H2 Wheel offset: 1.73 in (44 mm)
FA: 245/40 R20 99 Y XL <sup>3</sup> RA: 275/35 R20 102 Y XL <sup>2, 3</sup>	FA: 8.5 J x 20 H2 Wheel offset: 1.50 in (38 mm) <sup>5</sup> RA: 9.5 J x 20 H2 Wheel offset: 1.50 in (38 mm) <sup>5</sup>

<sup>2</sup> Use of snow chains not permitted. Observe the notes in the "Snow chains" section.

<sup>5</sup> Only in conjunction with AMG line (code 951).

<sup>3</sup> Available as MOExtended tires

<sup>4</sup> Not in conjunction with AMG line (code 951).



**All-weather tires****R18**

Tires	Wheels
BA: 245/50 R18 100 H M+S <sup>3,4</sup>	BA: 8.0 J x 18 H2 Wheel offset: 1.61 in (41 mm)

**R19**

Tires	Wheels
FA: 245/45 R19 102 H XL M+S <sup>3,4</sup> RA: 275/40 R19 101 H M+S <sup>2,3,4</sup>	FA: 8.5 J x 19 H2 Wheel offset: 1.42 in (36 mm) RA: 9.5 J x 19 H2 Wheel offset: 1.71 in (43.5 mm)
FA: 245/45 R19 102 H XL M+S <sup>3</sup> RA: 275/40 R19 101 H M+S <sup>2,3</sup>	FA: 8.5 J x 19 H2 Wheel offset: 1.50 in (38 mm) <sup>5</sup> RA: 9.5 J x 19 H2 Wheel offset: 1.50 in (38 mm) <sup>5</sup>

**Winter tires****R18**

Tires	Wheels
BA: 245/50 R18 104 V XL M+S  <sup>3</sup>	BA: 8.0 J x 18 H2 Wheel offset: 1.61 in (41 mm)

**R19**

Tires	Wheels
BA: 245/45 R19 102 V XL M+S  <sup>3</sup>	BA: 8.5 J x 19 H2 Wheel offset: 1.42 in (36 mm)
BA: 245/45 R19 102 V XL M+S  <sup>3</sup>	BA: 8.5 J x 19 H2 Wheel offset: 1.50 in (38 mm) <sup>5</sup>

<sup>3</sup> Available as MOExtended tires<sup>4</sup> Not in conjunction with AMG line (code 951).<sup>2</sup> Use of snow chains not permitted. Observe the notes in the "Snow chains" section.<sup>5</sup> Only in conjunction with AMG line (code 951).

## S 550 e

## Summer tires

## R18

Tires	Wheels
FA: 245/50 R18 100 W <sup>3</sup> RA: 275/45 R18 103 W <sup>2, 3</sup>	FA: 8.0 J x 18 H2 Wheel offset: 1.61 in (41 mm) RA: 9.5 J x 18 H2 Wheel offset: 1.71 in (43.5 mm)

## R19

Tires	Wheels
FA: 245/45 R19 102 Y XL <sup>3</sup> RA: 275/40 R19 101 Y <sup>2, 3</sup>	FA: 8.5 J x 19 H2 Wheel offset: 1.42 in (36 mm) RA: 9.5 J x 19 H2 Wheel offset: 1.71 in (43.5 mm)
FA: 245/45 R19 102 Y XL <sup>3</sup> RA: 275/40 R19 101 Y <sup>2, 3</sup>	FA: 8.5 J x 19 H2 Wheel offset: 1.50 in (38 mm) <sup>5</sup> RA: 9.5 J x 19 H2 Wheel offset: 1.50 in (38 mm) <sup>5</sup>

## R20

Tires	Wheels
FA: 245/40 R20 99 Y XL <sup>3</sup> RA: 275/35 R20 102 Y XL <sup>2, 3</sup>	FA: 8.5 J x 20 H2 Wheel offset: 1.42 in (36 mm) RA: 9.5 J x 20 H2 Wheel offset: 1.71 in (43.5 mm)
FA: 245/40 R20 99 Y XL <sup>3</sup> RA: 275/35 R20 102 Y XL <sup>2, 3</sup>	FA: 8.5 J x 20 H2 Wheel offset: 1.44 in (36.5 mm) RA: 9.5 J x 20 H2 Wheel offset: 1.73 in (44 mm)
FA: 245/40 R20 99 Y XL <sup>3</sup> RA: 275/35 R20 102 Y XL <sup>2, 3</sup>	FA: 8.5 J x 20 H2 Wheel offset: 1.50 in (38 mm) <sup>5</sup> RA: 9.5 J x 20 H2 Wheel offset: 1.50 in (38 mm) <sup>5</sup>

<sup>3</sup> Available as MOExtended tires

<sup>2</sup> Use of snow chains not permitted. Observe the notes in the "Snow chains" section.

<sup>5</sup> Only in conjunction with AMG line (code 951).

**All-weather tires****R19**

Tires	Wheels
FA: 245/45 R19 102 H XL M+S <sup>3,4</sup> RA: 275/40 R19 101 H M+S <sup>2,3,4</sup>	FA: 8.5 J x 19 H2 Wheel offset: 1.42 in (36 mm) RA: 9.5 J x 19 H2 Wheel offset: 1.71 in (43.5 mm)
FA: 245/45 R19 102 H XL M+S <sup>3</sup> RA: 275/40 R19 101 H M+S <sup>2,3</sup>	FA: 8.5 J x 19 H2 Wheel offset: 1.50 in (38 mm) <sup>5</sup> RA: 9.5 J x 19 H2 Wheel offset: 1.50 in (38 mm) <sup>5</sup>

**Winter tires****R18**

Tires	Wheels
BA: 245/50 R18 104 V XL M+S  <sup>3</sup>	BA: 8.0 J x 18 H2 Wheel offset: 1.61 in (41 mm)

**R19**

Tires	Wheels
BA: 245/45 R19 102 V XL M+S  <sup>3</sup>	BA: 8.5 J x 19 H2 Wheel offset: 1.42 in (36 mm)
BA: 245/45 R19 102 V XL M+S  <sup>3</sup>	BA: 8.5 J x 19 H2 Wheel offset: 1.50 in (38 mm) <sup>5</sup>

**S 550 4MATIC****Summer tires****R18**

Tires	Wheels
BA: 245/50 R18 100 W	BA: 8.0 J x 18 H2 Wheel offset: 1.61 in (41 mm)

<sup>3</sup> Available as MOExtended tires<sup>4</sup> Not in conjunction with AMG line (code 951).<sup>2</sup> Use of snow chains not permitted. Observe the notes in the "Snow chains" section.<sup>5</sup> Only in conjunction with AMG line (code 951).

## R19

Tires	Wheels
FA: 245/45 R19 102 Y XL RA: 275/40 R19 101 Y <sup>2</sup>	FA: 8.5 J x 19 H2 Wheel offset: 1.42 in (36 mm) RA: 9.5 J x 19 H2 Wheel offset: 1.71 in (43.5 mm)
FA: 245/45 R19 102 Y XL RA: 275/40 R19 101 Y <sup>2</sup>	FA: 8.5 J x 19 H2 Wheel offset: 1.50 in (38 mm) <sup>5</sup> RA: 9.5 J x 19 H2 Wheel offset: 1.50 in (38 mm) <sup>5</sup>

## R20

Tires	Wheels
FA: 245/40 R20 99 Y XL <sup>3,4</sup> RA: 275/35 R20 102 Y XL <sup>2,3,4</sup>	FA: 8.5 J x 20 H2 Wheel offset: 1.42 in (36 mm) RA: 9.5 J x 20 H2 Wheel offset: 1.71 in (43.5 mm)
FA: 245/40 R20 99 Y XL <sup>3,4</sup> RA: 275/35 R20 102 Y XL <sup>2,3,4</sup>	FA: 8.5 J x 20 H2 Wheel offset: 1.44 in (36.5 mm) RA: 9.5 J x 20 H2 Wheel offset: 1.73 in (44 mm)
FA: 245/40 R20 99 Y XL <sup>3</sup> RA: 275/35 R20 102 Y XL <sup>2,3</sup>	FA: 8.5 J x 20 H2 Wheel offset: 1.50 in (38 mm) <sup>5</sup> RA: 9.5 J x 20 H2 Wheel offset: 1.50 in (38 mm) <sup>5</sup>

## All-weather tires

## R18

Tires	Wheels
BA: 245/50 R18 100 H M+S <sup>3,4</sup>	BA: 8.0 J x 18 H2 Wheel offset: 1.61 in (41 mm)

<sup>2</sup> Use of snow chains not permitted. Observe the notes in the "Snow chains" section.

<sup>5</sup> Only in conjunction with AMG line (code 951).

<sup>3</sup> Available as MOExtended tires

<sup>4</sup> Not in conjunction with AMG line (code 951).

## R19

Tires	Wheels
FA: 245/45 R19 102 H XL M+S <sup>3,4</sup> RA: 275/40 R19 101 H M+S <sup>2,3,4</sup>	FA: 8.5 J x 19 H2 Wheel offset: 1.42 in (36 mm) RA: 9.5 J x 19 H2 Wheel offset: 1.71 in (43.5 mm)
FA: 245/45 R19 102 H XL M+S <sup>3</sup> RA: 275/40 R19 101 H M+S <sup>2,3</sup>	FA: 8.5 J x 19 H2 Wheel offset: 1.50 in (38 mm) <sup>5</sup> RA: 9.5 J x 19 H2 Wheel offset: 1.50 in (38 mm) <sup>5</sup>

## Winter tires

## R18

Tires	Wheels
BA: 245/50 R18 104 V XL M+S  <sup>3</sup>	BA: 8.0 J x 18 H2 Wheel offset: 1.61 in (41 mm)

## R19

Tires	Wheels
BA: 245/45 R19 102 V XL M+S  <sup>3</sup>	BA: 8.5 J x 19 H2 Wheel offset: 1.42 in (36 mm)
BA: 245/45 R19 102 V XL M+S  <sup>3</sup>	BA: 8.5 J x 19 H2 Wheel offset: 1.50 in (38 mm) <sup>5</sup>

## S 600

## Summer tires

## R19

Tires	Wheels
FA: 245/45 R19 102 Y XL RA: 275/40 R19 101 Y <sup>2</sup>	FA: 8.5 J x 19 H2 Wheel offset: 1.42 in (36 mm) RA: 9.5 J x 19 H2 Wheel offset: 1.71 in (43.5 mm)

<sup>3</sup> Available as MOExtended tires

<sup>4</sup> Not in conjunction with AMG line (code 951).

<sup>2</sup> Use of snow chains not permitted. Observe the notes in the "Snow chains" section.

<sup>5</sup> Only in conjunction with AMG line (code 951).

## R20

Tires	Wheels
FA: 245/40 R20 99 Y XL <sup>3,4</sup> RA: 275/35 R20 102 Y XL <sup>2,3,4</sup>	FA: 8.5 J x 20 H2 Wheel offset: 1.42 in (36 mm) RA: 9.5 J x 20 H2 Wheel offset: 1.71 in (43.5 mm)
FA: 245/40 R20 99 Y XL <sup>3,4</sup> RA: 275/35 R20 102 Y XL <sup>2,3,4</sup>	FA: 8.5 J x 20 H2 Wheel offset: 1.44 in (36.5 mm) RA: 9.5 J x 20 H2 Wheel offset: 1.73 in (44 mm)
FA: 245/40 R20 99 Y XL <sup>3</sup> RA: 275/35 R20 102 Y XL <sup>2,3</sup>	FA: 8.5 J x 20 H2 Wheel offset: 1.50 in (38 mm) <sup>5</sup> RA: 9.5 J x 20 H2 Wheel offset: 1.50 in (38 mm) <sup>5</sup>

## All-weather tires

## R19

Tires	Wheels
FA: 245/45 R19 102 H XL M+S <sup>3,4</sup> RA: 275/40 R19 101 H M+S <sup>2,3,4</sup>	FA: 8.5 J x 19 H2 Wheel offset: 1.42 in (36 mm) RA: 9.5 J x 19 H2 Wheel offset: 1.71 in (43.5 mm)
FA: 245/45 R19 102 H XL M+S <sup>3</sup> RA: 275/40 R19 101 H M+S <sup>2,3</sup>	FA: 8.5 J x 19 H2 Wheel offset: 1.50 in (38 mm) <sup>5</sup> RA: 9.5 J x 19 H2 Wheel offset: 1.50 in (38 mm) <sup>5</sup>

## Winter tires

## R19

Tires	Wheels
BA: 245/45 R19 102 V XL M+S  <sup>3</sup>	BA: 8.5 J x 19 H2 Wheel offset: 1.42 in (36 mm)
BA: 245/45 R19 102 V XL M+S  <sup>3</sup>	BA: 8.5 J x 19 H2 Wheel offset: 1.50 in (38 mm) <sup>5</sup>

<sup>3</sup> Available as MOExtended tires<sup>4</sup> Not in conjunction with AMG line (code 951).<sup>2</sup> Use of snow chains not permitted. Observe the notes in the "Snow chains" section.<sup>5</sup> Only in conjunction with AMG line (code 951).

## Mercedes-Maybach S 600

## Summer tires

## R19

Tires	Wheels
FA: 245/45 R19 102 Y XL <sup>3</sup> RA: 275/40 R19 101 Y <sup>2, 3</sup>	FA: 8.5 J x 19 H2 Wheel offset: 1.42 in (36 mm) RA: 9.5 J x 19 H2 Wheel offset: 1.71 in (43.5 mm)

## R20

Tires	Wheels
FA: 245/40 R20 99 Y XL <sup>3, 4</sup> RA: 275/35 R20 102 Y XL <sup>2, 3, 4</sup>	FA: 8.5 J x 20 H2 Wheel offset: 1.42 in (36 mm) RA: 9.5 J x 20 H2 Wheel offset: 1.71 in (43.5 mm)
FA: 245/40 R20 99 Y XL <sup>3, 4</sup> RA: 275/35 R20 102 Y XL <sup>2, 3, 4</sup>	FA: 8.5 J x 20 H2 Wheel offset: 1.44 in (36.5 mm) RA: 9.5 J x 20 H2 Wheel offset: 1.73 in (44 mm)

## All-weather tires

## R19

Tires	Wheels
FA: 245/45 R19 102 H XL M+S <sup>3, 4</sup> RA: 275/40 R19 101 H M+S <sup>2, 3, 4</sup>	FA: 8.5 J x 19 H2 Wheel offset: 1.42 in (36 mm) RA: 9.5 J x 19 H2 Wheel offset: 1.71 in (43.5 mm)

## Winter tires

## R19

Tires	Wheels
BA: 245/45 R19 102 V XL M+S  <sup>3</sup>	BA: 8.5 J x 19 H2 Wheel offset: 1.42 in (36 mm)

<sup>3</sup> Available as MOExtended tires

<sup>2</sup> Use of snow chains not permitted. Observe the notes in the "Snow chains" section.

<sup>4</sup> Not in conjunction with AMG line (code 951).

## Mercedes-AMG S 63 4MATIC

## Summer tires

## R19



Tires	Wheels
FA: 255/45 ZR19 (104 Y) XL <sup>6</sup> RA: 285/40 ZR19 (107 Y) XL <sup>2,6</sup>	FA: 8.5 J x 19 H2 Wheel offset: 1.50 in (38 mm) RA: 9.5 J x 19 H2 Wheel offset: 1.50 in (38 mm)
FA: 255/45 ZR19 (104 Y) XL <sup>6</sup> RA: 285/40 ZR19 (107 Y) XL <sup>2,6</sup>	FA: 8.5 J x 19 H2 Wheel offset: 1.54 in (39 mm) RA: 9.5 J x 19 H2 Wheel offset: 1.54 in (39 mm)

## R20

Tires	Wheels
FA: 255/40 ZR20 (101 Y) XL RA: 285/35 ZR20 (104 Y) XL <sup>2</sup>	FA: 8.5 J x 20 H2 Wheel offset: 1.50 in (38 mm) RA: 9.5 J x 20 H2 Wheel offset: 1.50 in (38 mm)
FA: 255/40 ZR20 (101 Y) XL RA: 285/35 ZR20 (104 Y) XL <sup>2</sup>	FA: 8.5 J x 20 H2 Wheel offset: 1.54 in (39 mm) RA: 9.5 J x 20 H2 Wheel offset: 1.54 in (39 mm)

## Winter tires

## R19







Tires	Wheels
BA: 255/45 R19 104 V XL M+S  <sup>6</sup>	BA: 8.5 J x 19 H2 Wheel offset: 1.50 in (38 mm)
BA: 255/45 R19 104 V XL M+S  <sup>6</sup>	BA: 8.5 J x 19 H2 Wheel offset: 1.54 in (39 mm)

<sup>6</sup> Not in combination with a ceramic brake system.

<sup>2</sup> Use of snow chains not permitted. Observe the notes in the "Snow chains" section.



## R20

Tires	Wheels
BA: 255/40 R20 101 V XL M+S 	BA: 8.5 J x 20 H2 Wheel offset: 1.50 in (38 mm)
BA: 255/40 R20 101 V XL M+S 	BA: 8.5 J x 20 H2 Wheel offset: 1.54 in (39 mm)
FA: 255/40 R20 101 V XL M+S  RA: 285/35 R20 104 V XL M+S  <sup>2</sup>	FA: 8.5 J x 20 H2 Wheel offset: 1.50 in (38 mm) RA: 9.5 J x 20 H2 Wheel offset: 1.50 in (38 mm)
FA: 255/40 R20 101 V XL M+S  RA: 285/35 R20 104 V XL M+S  <sup>2</sup>	FA: 8.5 J x 20 H2 Wheel offset: 1.54 in (39 mm) RA: 9.5 J x 20 H2 Wheel offset: 1.54 in (39 mm)

## Mercedes-AMG S 65



## Summer tires

## R20





Tires	Wheels
FA: 255/40 ZR20 (101 Y) XL RA: 285/35 ZR20 (104 Y) XL <sup>2</sup>	FA: 8.5 J x 20 H2 Wheel offset: 1.50 in (38 mm) RA: 9.5 J x 20 H2 Wheel offset: 1.50 in (38 mm)
FA: 255/40 ZR20 (101 Y) XL RA: 285/35 ZR20 (104 Y) XL <sup>2</sup>	FA: 8.5 J x 20 H2 Wheel offset: 1.54 in (39 mm) RA: 9.5 J x 20 H2 Wheel offset: 1.54 in (39 mm)

## Winter tires

## R20

Tires	Wheels
BA: 255/40 R20 101 V XL M+S 	BA: 8.5 J x 20 H2 Wheel offset: 1.50 in (38 mm)
BA: 255/40 R20 101 V XL M+S 	BA: 8.5 J x 20 H2 Wheel offset: 1.54 in (39 mm)

<sup>2</sup> Use of snow chains not permitted. Observe the notes in the "Snow chains" section.

Tires	Wheels
FA: 255/40 R20 101 V XL M+S  RA: 285/35 R20 104 V XL M+S  <sup>2</sup>	FA: 8.5 J x 20 H2 Wheel offset: 1.50 in (38 mm) RA: 9.5 J x 20 H2 Wheel offset: 1.50 in (38 mm)
FA: 255/40 R20 101 V XL M+S  RA: 285/35 R20 104 V XL M+S  <sup>2</sup>	FA: 8.5 J x 20 H2 Wheel offset: 1.54 in (39 mm) RA: 9.5 J x 20 H2 Wheel offset: 1.54 in (39 mm)

<sup>2</sup> Use of snow chains not permitted. Observe the notes in the "Snow chains" section.

### Useful information

- i** This Operator's Manual describes all models and all standard and optional equipment of your vehicle available at the time of publication of the Operator's Manual. Country-specific differences are possible. Please note that your vehicle may not be equipped with all features described. This also applies to safety-related systems and functions.
- i** Read the information on qualified specialist workshops (▷ page 28).

### Information regarding technical data

- i** The data stated here specifically refers to a vehicle with standard equipment. Consult an authorized Mercedes-Benz Center for the data for all vehicle variants and trim levels.

## Vehicle electronics

### Retrofitting two-way radios and mobile phones (RF transmitters)

#### **⚠ WARNING**

The electromagnetic radiation from modified or incorrectly retrofitted RF-transmitters can interfere with the vehicle electronics. This can compromise the operational safety of the vehicle. There is a risk of an accident.

You should have all work to electrical and electronic equipment carried out at a qualified specialist workshop.

#### **⚠ WARNING**

The electromagnetic radiation from incorrectly operated RF transmitters can interfere with the vehicle electronics, for example:

- if the RF transmitter is not connected with an exterior antenna
- the exterior antenna has been installed incorrectly or is not a low-reflection type

This can compromise the operational safety of the vehicle. There is a risk of an accident.

Have the low-reflection exterior antenna mounted at a qualified specialist workshop. When operating RF transmitters in the vehicle, always connect them with the low-reflection exterior antenna.

- !** The operating permit may be invalidated if the instructions for installation and use of RF transmitters are not observed.

In particular, the following conditions must be complied with:

- only approved wavebands may be used.
- compliance with the maximum permissible output in these wavebands is required.
- only approved antenna positions may be used.

Excessive levels of electromagnetic radiation may cause damage to your health and the health of others. Using an exterior antenna takes into account current scientific discussions relating to the possible health hazards that may result from electromagnetic fields.

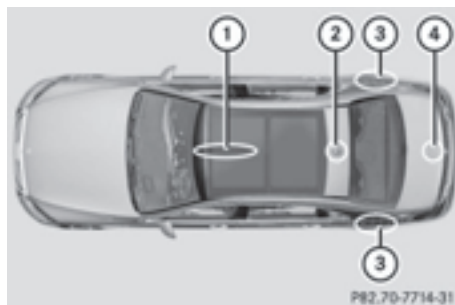

Approved antenna positions (example: Mercedes-Maybach)

- ① Front roof area
- ② Rear roof area
- ③ Rear fender
- ④ Trunk lid

- i** On vehicles with panorama roof with power tilt/sliding panel, installing an antenna to the front or rear roof area is not permitted.

On the rear fenders, it is recommended to position the antenna on the side of the vehicle closest to the center of the road.

Use the Technical Specification ISO/TS 21609 when retrofitting RF transmitters (Road Vehicles - EMC guidelines for installation of aftermarket

radio frequency transmitting equipment). Observe the legal requirements for retrofittings.

If your vehicle has installations for two-way radio equipment, use the power supply or antenna connections intended for use with the basic wiring. Be sure to observe the manufacturer's additional instructions when installing.

Deviations with respect to wavebands, maximum transmission outputs or antenna positions must be approved by Mercedes-Benz.

The maximum transmission output (PEAK) at the base of the antenna must not exceed the following values:

Waveband	Maximum transmission output
Short wave 3 - 54 MHz	100 W
4 m waveband 74 - 78 MHz	30 W
2 m waveband 144 - 174 MHz	50 W
Trunked radio/Tetra 380 - 460 MHz	10 W
70 cm waveband 400 - 460 MHz	35 W
Mobile communications (2G/3G/4G)	10 W

The following can be used in the vehicle without restrictions:

- RF transmitters with a maximum transmission output of up to 100 mW
- RF transmitters with transmitter frequencies in the 380 - 410 MHz waveband and a maximum transmission output of up to 2 W (trunked radio/Tetra)
- Mobile telephones (2G/3G/4G)

There is no restriction for antenna positions on the outside of the vehicle for the following wavebands:

- Trunked radio/Tetra
- 70 cm waveband
- 2G/3G/4G

## Identification plates

### Vehicle identification plate with vehicle identification number (VIN)



Location of vehicle identification plate (example, left-hand-drive vehicle)

- Open the front left-hand door. You will see vehicle identification plate ①.



Example: vehicle identification plate (USA only)

- ② VIN
- ③ Vehicle model



Example: vehicle identification plate (Canada only)

- ② VIN
- ③ Paint code

- i** The data shown on the vehicle identification plate is used only as an example. This data is different for every vehicle and can deviate from the data shown here. You can find the data applicable to your vehicle on the vehicle identification plate.

### Vehicle identification number (VIN)



- ▶ Open the front right-hand door.
- ▶ Fold cover ① down and remove it. You will see the VIN.

The VIN can also be found in the following locations:

- on the lower edge of the windshield (▷ page 427)
- on the vehicle identification plate (▷ page 426)

### Engine number

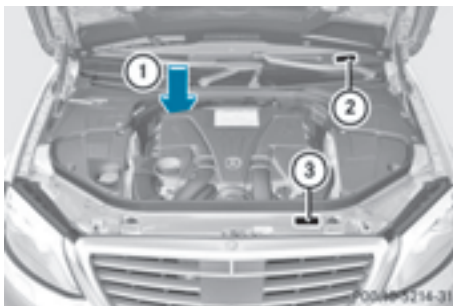

- ① Engine number (stamped into the crankcase)
- ② VIN (on the lower edge of the windshield)
- ③ Emission control information plate, including the certification of both federal and Californian emissions standards

## Service products and filling capacities

### Important safety notes

#### WARNING

Service products may be poisonous and hazardous to health. There is a risk of injury.

Comply with instructions on the use, storage and disposal of service products on the labels of the respective original containers. Always store service products sealed in their original containers. Always keep service products out of the reach of children.

#### Environmental note

Dispose of service products in an environmentally responsible manner.

Service products include the following:

- Fuels
- Lubricants (e.g. engine oil, transmission oil)
- Coolant
- Brake fluid
- Windshield washer fluid
- Climate control system refrigerant

Components and service products must be matched. Only use products recommended by Mercedes-Benz. Damage which is caused by the use of products which have not been recommended is not covered by the Mercedes-Benz warranty or goodwill gestures. They are listed in this Mercedes-Benz Operator's Manual in the appropriate section.

Information on tested and approved products can be obtained at an authorized Mercedes-Benz Center or on the Internet at <http://bevo.mercedes-benz.com>.

You can recognize service products approved by Mercedes-Benz by the following inscription on the containers:

- MB-Freigabe (e.g. MB-Freigabe 229.51)
- MB-Approval (e.g. MB-Approval 229.51)

Other designations or recommendations indicate a level of quality or a specification in accordance with an MB Sheet Number (e.g. MB 229.5). They have not necessarily been approved by Mercedes-Benz.

Other identifications, for example:

- 0 W-30
- 5 W-30
- 5 W-40

## Fuel

### Important safety notes

#### WARNING

Fuel is highly flammable. If you handle fuel incorrectly, there is a risk of fire and explosion.

You must avoid fire, open flames, creating sparks and smoking. Switch off the engine and, if applicable, the auxiliary heating before refueling.

#### WARNING

Fuel is poisonous and hazardous to health. There is a risk of injury.

You must make sure that fuel does not come into contact with your skin, eyes or clothing and that it is not swallowed. Do not inhale fuel vapors. Keep fuel away from children.

If you or others come into contact with fuel, observe the following:

- Wash away fuel from skin immediately using soap and water.
- If fuel comes into contact with your eyes, immediately rinse them thoroughly with clean water. Seek medical assistance without delay.
- If fuel is swallowed, seek medical assistance without delay. Do not induce vomiting.
- Immediately change out of clothing which has come into contact with fuel.

### Tank capacity

Missing values were not available at time of going to print.

Model	Total capacity
<b>S 400 4MATIC</b>	
<b>PLUG-IN HYBRID vehicles</b>	16.6 US gal (63.0 l)
<b>All other models</b>	21.1 US gal (80.0 l)

Model	Of which reserve
<b>S 400 4MATIC</b>	
<b>Mercedes-AMG vehicles</b>	Approx. 3.2 US gal (12.0 l)
<b>All other models</b>	Approx. 2.1 US gal (8.0 l)

### Gasoline

#### Fuel grade

 Do not use diesel to refuel vehicles with a gasoline engine. Do not switch on the ignition if you accidentally refuel with the wrong fuel. Otherwise, the fuel will enter the fuel system. Even small amounts of the wrong fuel could result in damage to the fuel system and the engine. Notify a qualified specialist workshop and have the fuel tank and fuel lines drained completely.

 Only refuel using unleaded premium grade gasoline with at least 91 AKI/95 RON.

 E10 fuel contains up to 10% bioethanol. Your vehicle is E10-compatible. You can refuel your vehicle using E10 fuel.

 Only use the fuel recommended. Operating the vehicle with other fuels can lead to engine failure.

 Do not use the following:

- E15 (gasoline with 15% ethanol)
- E85 (gasoline with 85% ethanol)
- E100 (100% ethanol)
- M15 (gasoline with 15% methanol)

- M30 (gasoline with 30% methanol)
- M85 (gasoline with 85% methanol)
- M100 (100% methanol)
- Gasoline with metalliferous additives
- Diesel

Do not mix such fuels with the fuel recommended for your vehicle.

**!** To ensure the longevity and full performance of the engine, only premium-grade unleaded gasoline must be used.

If standard unleaded gasoline is unavailable and you have to refuel with unleaded gasoline of a lower grade, observe the following precautions:

- Only fill the fuel tank to half full with regular unleaded gasoline and fill the rest with premium-grade unleaded gasoline as soon as possible.
- Do not drive at the maximum speed.
- Avoid sudden acceleration and engine speeds over 3,000 rpm.

You will usually find information about the fuel grade on the pump. If you cannot find the label on the pump, ask the staff for assistance.

**i** For further information, consult a qualified specialist workshop or visit <http://www.mbusa.com> (USA only).

As a temporary measure, if the recommended fuel is not available, you may also use regular unleaded gasoline with an octane rating of 87 AKI/91 RON. This may reduce engine performance and increase fuel consumption. Avoid driving at full throttle and sudden acceleration. Never refuel using fuel with a lower AKI. Information on refueling .

### Additives

**!** Operating the engine with fuel additives added later can lead to engine failure. Do not mix fuel additives with fuel. This does not include additives for the removal and prevention of residue buildup. Gasoline must only be mixed with additives recommended by Mercedes-Benz. Comply with the instructions for use on the product label. More information about recommended additives can be obtained from any authorized Mercedes-Benz Center.

Mercedes-Benz recommends that you use branded fuels that have additives.

The quality of the fuel available in some countries may not be sufficient. Residue could build up in the injection system as a result. In such cases, and in consultation with an authorized Mercedes-Benz Center, the gasoline may be mixed with the cleaning additive recommended by Mercedes-Benz. You must observe the notes and mixing ratios specified on the container.

## Engine oil

### General notes



**!** Never use engine oil or an oil filter of a specification other than is necessary to fulfill the prescribed service intervals. Do not change the engine oil or oil filter in order to achieve longer replacement intervals than those prescribed. You could otherwise cause engine damage or damage to the exhaust gas after-treatment.

Follow the instructions in the service interval display regarding the oil change. Otherwise, you may damage the engine and the exhaust gas aftertreatment.

When handling engine oil, observe the important safety notes on service products (> page 427).

The engine oils are matched to the performance of Mercedes-Benz engines and service intervals. You should therefore only use engine oils and oil filters that are approved for vehicles with maintenance systems.

For a list of approved engine oils and oil filters, consult an authorized Mercedes-Benz Center. Or visit the website <http://bevo.mercedes-benz.com>.

The table shows which engine oils have been approved for your vehicle.

Model	MB-Freigabe or MB-Approval
All models	229.5

Use only SAE 0W-40 or SAE 5W-40 engine oils for Mercedes-AMG vehicles.

**i** MB approval is indicated on the oil containers.

### Filling capacities

The following values refer to an oil change including the oil filter.

Missing values were not available at time of going to print.

Model	Capacity
S 400 4MATIC	
S 550 e	6.9 US qt (6.5 l)
S 600	11.1 US qt (10.5 l)
Mercedes-Maybach S 600	
Mercedes-AMG S 65	
Mercedes-AMG S 63 4MATIC	9.0 US qt (8.5 l)
All other models	8.5 US qt (8.0 l)

### Additives

**!** Do not use any additives in the engine oil. This could damage the engine.

### Engine oil viscosity

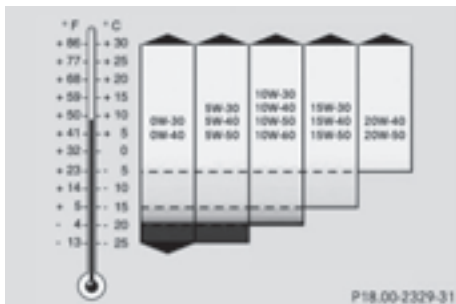

Viscosity describes the flow characteristics of a fluid. If an engine oil has a high viscosity, this means that it is thick; a low viscosity means that it is thin.

Select an engine oil with an SAE classification (viscosity) suitable for the prevailing outside temperatures. The table shows you which SAE classifications are to be used. The low-temperature characteristics of engine oils can deteriorate significantly, e.g. as a result of aging, soot and fuel deposits. It is therefore strongly recommended that you carry out regular oil changes using an approved engine oil with the appropriate SAE classification.

### Brake fluid

#### **⚠ WARNING**

The brake fluid constantly absorbs moisture from the air. This lowers the boiling point of the brake fluid. If the boiling point of the brake fluid is too low, vapor pockets may form in the brake system when the brakes are applied hard. This would impair braking efficiency. There is a risk of an accident.

You should have the brake fluid renewed at the specified intervals.

Comply with the important safety notes for service products when handling brake fluid (> page 427).

The brake fluid change intervals can be found in the Maintenance Booklet.

Only use brake fluid approved by Mercedes-Benz according to MB-Freigabe or MB-Approval 331.0.

Information about approved brake fluid can be obtained at any qualified specialist workshop or on the Internet at

<http://bevo.mercedes-benz.com>.

**i** Have the brake fluid regularly replaced at a qualified specialist workshop and the replacement confirmed in the Maintenance Booklet.



## Coolant

### Important safety notes

#### WARNING

If antifreeze comes into contact with hot components in the engine compartment, it may ignite. There is a risk of fire and injury.

Let the engine cool down before you add antifreeze. Make sure that antifreeze is not spilled next to the filler neck. Thoroughly clean the antifreeze from components before starting the engine.

**!** Only add coolant that has been premixed with the desired antifreeze protection. You could otherwise damage the engine.

Further information on coolants can be found in the Mercedes-Benz Specifications for Service Products, MB BeVo 3 10. 1, e.g. on the Internet at <http://bevo.mercedes-benz.com>. Or contact a qualified specialist workshop.

**!** Always use a suitable coolant mixture, even in countries where high temperatures prevail. Otherwise, the engine cooling system is not sufficiently protected from corrosion and overheating.

**i** Have the coolant regularly replaced at a qualified specialist workshop and the replacement confirmed in the Maintenance Booklet.

The coolant is a mixture of water and antifreeze/corrosion inhibitor. It performs the following tasks:

- corrosion protection
- antifreeze protection
- raising the boiling point

If the coolant has antifreeze protection down to -35 °F (-37 °C), the boiling point of the coolant during operation is approximately 266 °F (130 °C).

The antifreeze concentrate/corrosion inhibitor concentration in the engine cooling system should:

- be at least 50%. This will protect the engine cooling system against freezing down to approximately -35 °F (-37 °C).
- not exceed 55% (antifreeze protection down to -49 °F [-45 °C]). Otherwise, heat will not be dissipated as effectively.

Mercedes-Benz recommends an antifreeze/corrosion inhibitor concentrate in accordance with MB Specifications for Service Products 3 10. 1.

- i** When the vehicle is first delivered, it is filled with a coolant mixture that ensures adequate antifreeze and corrosion protection.
- i** The coolant is checked with every maintenance interval at a qualified specialist workshop.

### Filling capacities

Missing values were not available at time of going to print.

Model	Capacity
<b>S 400 4MATIC</b>	
<b>S 550 e</b>	13.3 US qt (12.6 l)
<b>S 600</b>	15.7 US qt (14.9 l)
<b>Mercedes-Maybach S 600</b>	
<b>Mercedes-AMG S 63 4MATIC</b>	8.5 US qt (8.0 l)
<b>Mercedes-AMG S 65</b>	11.3 US qt (10.7 l)
<b>All other models</b>	12.8 US qt (12.1 l)

## Windshield washer system

### Important safety notes

#### WARNING

Windshield washer concentrate could ignite if it comes into contact with hot engine components or the exhaust system. There is a risk of fire and injury.

Make sure that no windshield washer concentrate is spilled next to the filler neck.

**!** Do not add distilled or de-ionized water to the washer fluid container. Otherwise, the level sensor may be damaged.

**!** Only MB SummerFit and MB WinterFit washer fluid should be mixed together. The

spray nozzles may otherwise become blocked.

At temperatures above freezing:

- ▶ Fill the washer fluid reservoir with a mixture of water and windshield washer fluid, e.g. MB SummerFit.

Add 1 part MB SummerFit to 100 parts water.

At temperatures below freezing:

- ▶ Fill the washer fluid reservoir with a mixture of water and washer fluid, e.g. MB WinterFit.

For the correct mixing ratio refer to the information on the antifreeze reservoir.

- ❗ Add windshield washer fluid, e.g. MB SummerFit or MB WinterFit, to the washer fluid all year round.

### Climate control system refrigerant

#### Important safety notes

The climate control system of your vehicle is filled with refrigerant R-134a.

The instruction label regarding the refrigerant type used can be found on the radiator cross member.

- ❗ Only the refrigerant R-134a and the PAG oil approved by Mercedes-Benz may be used. The approved PAG oil may not be mixed with any other PAG oil that is not approved for R-134a refrigerant. Otherwise, the climate control system may be damaged.

Service work, such as topping up refrigerant or replacing components, may only be carried out by a qualified specialist workshop. All applicable regulations, as well as SAE standard J639, must be adhered to.

Always have work on the climate control system carried out at a qualified specialist workshop.

### Refrigerant instruction label



Example: refrigerant instruction label

- ① Warning symbol
- ② Refrigerant filling capacity
- ③ Applicable SAE standards
- ④ PAG oil part number
- ⑤ Type of refrigerant

Warning symbols ① indicate:

- possible dangers
- having service work carried out at a qualified specialist workshop

### Filling capacities

Model	Refrigerant
<b>S 550 e</b> <b>Mercedes-AMG vehicles</b>	25.0 ± 0.4 oz (710 ± 10 g)

Model	PAG oil
<b>S 550 e</b> <b>Mercedes-AMG vehicles</b>	4.3 oz (120 g)

Vehicles without rear-compartment air-conditioning system	Capacity
<b>Refrigerant</b>	23.3 ± 0.4 oz (660 ± 10 g)
<b>PAG oil</b>	3.9 oz (110 g)

Vehicles with rear-compartment air-conditioning system	Capacity
Refrigerant	27.1 ± 0.4 oz (770 ± 10 g)
PAG oil	4.2 oz (120 g)

## Vehicle data

### General notes

Please note that for the specified vehicle data:

- the heights specified may vary as a result of:
  - tires
  - load
  - condition of the suspension
  - optional equipment
- optional equipment reduces the maximum payload.

### Dimensions and weights

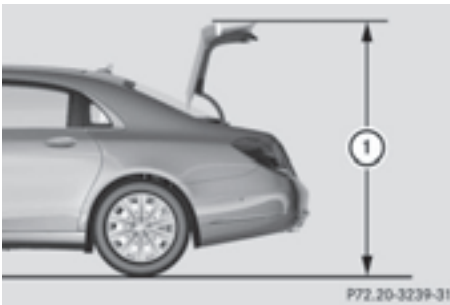

Trunk lid opening dimensions (example: Mercedes-Maybach)

Missing values were not available at time of going to print.

Model	① Opening height
S 400 4MATIC	
S 550 4MATIC	
S 550	71.0 in (1803 mm)

Model	① Opening height
Mercedes-AMG vehicles	71.2 in (1808 mm)
All other models	71.1 in (1806 mm)

### S-Class with a short wheelbase

All models	
Vehicle length	201.4 in (5116 mm)
Vehicle width including exterior mirrors	83.9 in (2130 mm)
Vehicle height	59.0 in (1499 mm)
Wheelbase	119.5 in (3035 mm)
Turning radius	39.0 ft (11.90 m)
Maximum roof load	220 lb (100 kg)
Maximum trunk load	220 lb (100 kg)

### S-Class with a long wheelbase

Missing values were not available at time of going to print.

S 400 4MATIC	
Vehicle length	
Vehicle height	
Vehicle width including exterior mirrors	
Wheelbase	
Turning radius	
Maximum roof load	
Maximum trunk load	

Mercedes-AMG vehicles	
Vehicle length	208.1 in (5287 mm)
Vehicle height	59.0 in (1499 mm)
Vehicle width including exterior mirrors	83.9 in (2130 mm)
Wheelbase	124.6 in (3165 mm)
Turning circle, Mercedes-AMG S 63 4MATIC	41.0 ft (12.50 m)
Turning circle, Mercedes-AMG S 65	40.4 ft (12.30 m)
Maximum roof load	220 lb (100 kg)
Maximum trunk load	220 lb (100 kg)

All other models	
Vehicle length	206.5 in (5246 mm)
Vehicle width including exterior mirrors	83.9 in (2130 mm)
Wheelbase	124.6 in (3165 mm)
Turning radius	40.4 ft (12.30 m)
Maximum roof load	220 lb (100 kg)
Maximum trunk load	220 lb (100 kg)

Model	Vehicle height
S 550	58.8 in (1494 mm)
S 550 4MATIC	
S 550 e S 600	58.9 in (1497 mm)

High-voltage battery (S 550 e)	
Model	Lithium-ion
Energy content	

High-voltage battery (S 550 e)	
Nominal capacity	
Range in electric-only mode (according to NEDC)	
Charging time at 16 A (using a charging station or wallbox)	
Charging time at 8 A (using a mains socket)	

Mercedes-Maybach	
All models	
Vehicle length	214.7 in (5453 mm)
Vehicle height	59.0 in (1498 mm)
Vehicle width including exterior mirrors	83.9 in (2130 mm)
Wheelbase	132.5 in (3365 mm)
Turning radius	42.3 ft (12.90 m)
Maximum trunk load	220 lb (100 kg)



